

# THE DIRC DETECTORS FOR THE PANDA EXPERIMENT AT FAIR

Jochen Schwiening

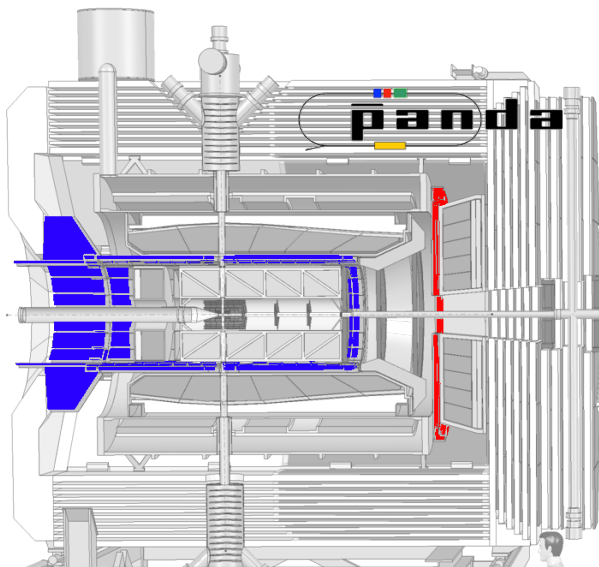

for the PANDA Cherenkov Group



- PANDA Experiment
- DIRC Concept
- **Barrel** & **Disk** DIRC Design
- Prototypes and R&D

**PANDA:** Anti-Proton ANnihilation at DArmstadt (450 physicists, 17 countries)  
 future experiment at new international FAIR facility at GSI  
 (German national lab for heavy ion research near Darmstadt)



High-intensity anti-proton beam on internal pellet/cluster target.



- Average production rate:  $2 \times 10^7/\text{sec}$ ;
- Beam momentum 1.5 ... 15 GeV/c;  $\Delta p/p$  as good as  $10^{-5}$ ;
- Luminosity up to  $2 \times 10^{32} \text{ cm}^{-2}\text{s}^{-1}$ .

## Study of QCD with Antiprotons

- Charmonium Spectroscopy;
- Search for Exotics; Hadrons in Medium;
- Nucleon Structure; Hypernuclear Physics.

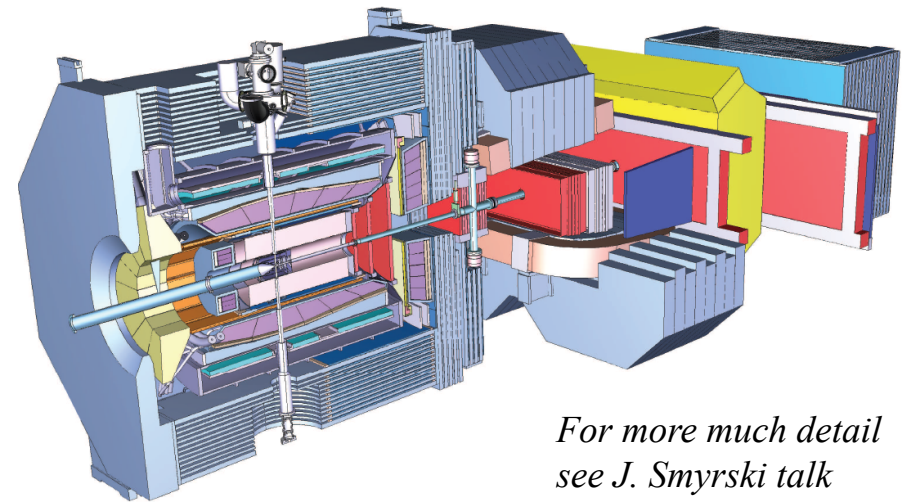

*For more much detail  
 see J. Smyrski talk*

## Particle identification essential

- Momentum range 200 MeV/c – 10 GeV/c.
- Several PID methods needed to cover entire momentum range.
- $dE/dx$ , EM showers, Cherenkov radiation in forward & target spectrometer configuration.

Cherenkov detectors in PANDA target spectrometers: Barrel DIRC & Disk DIRC

**Detection of Internally Reflected Cherenkov Light**

Novel type of Ring Imaging Cherenkov detector §  
 based on total internal reflection of Cherenkov light.

Used for the first time in BABAR for hadronic particle ID (8+ years in factory mode).

Recent improvements in photon detectors have motivated R&D efforts to improve the successful BABAR-DIRC and make DIRCs interesting for future experiments.

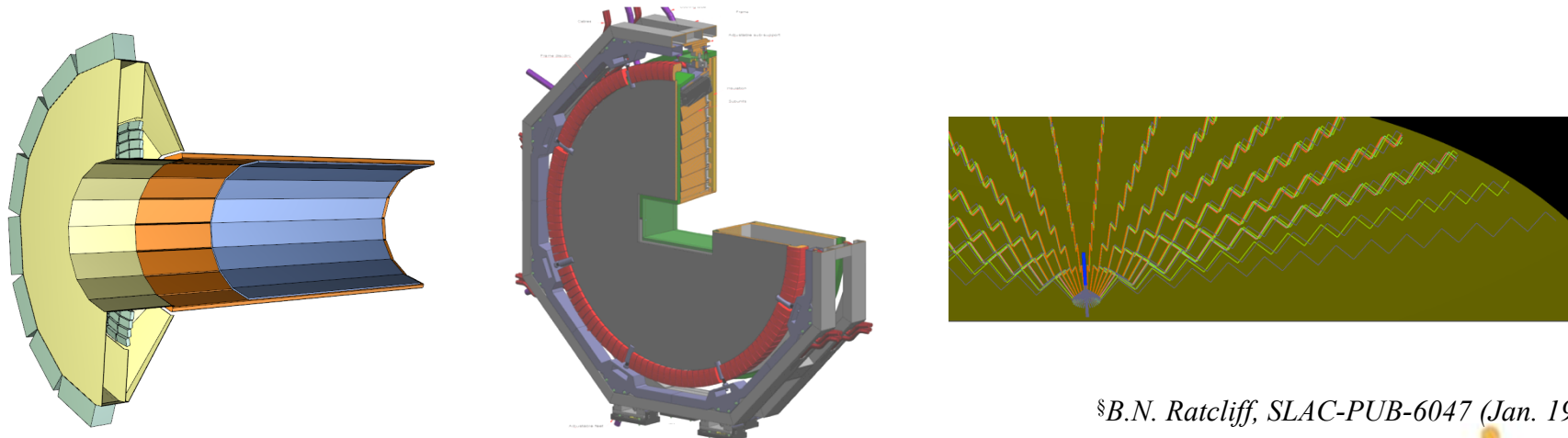

§B.N. Ratcliff, SLAC-PUB-6047 (Jan. 1993)

- **Charged particle** traversing radiator with refractive index  $n$  with  $\beta = v/c > 1/n$  emits **Cherenkov photons** on cone with half opening angle  $\cos \theta_c = 1/\beta n(\lambda)$ .
- For  $n > \sqrt{2}$  some photons are always **totally internally reflected** for  $\beta \approx 1$  tracks.
- **Radiator and light guide**: bar, plate, or disk made from **Synthetic Fused Silica** (“Quartz”) or fused quartz or acrylic glass or ...
- Magnitude of Cherenkov angle conserved during internal reflections (provided optical surfaces are square, parallel, highly polished)
- Mirror attached to one bar end, reflects photon back towards readout end.

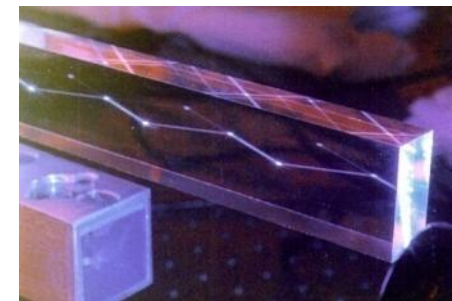
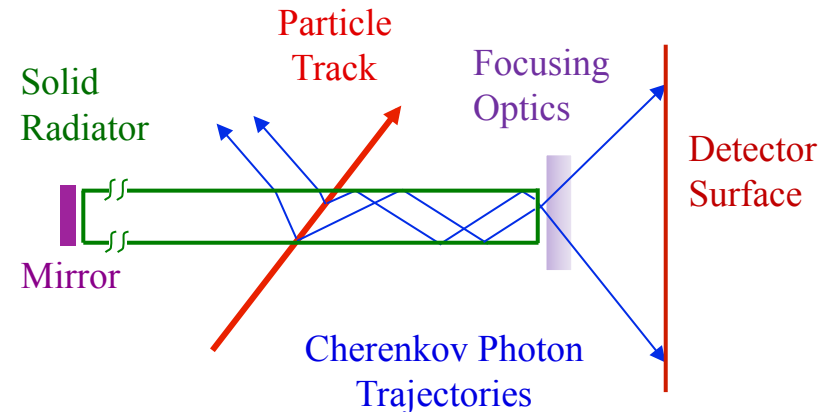

- Photons exit radiator via (optional) **focusing optics** into **expansion region**, detected on **photon detector array**.

- DIRC is intrinsically a **3-D device**, measuring: **x, y, and time** of Cherenkov photons, defining  $\theta_c$ ,  $\phi_c$ ,  $t_{\text{propagation}}$ .

- **Ultimate deliverable for DIRC: PID likelihoods.**

Calculate likelihood for observed hit pattern (in detector space or in Cherenkov space) to be produced by  $e/\mu/\pi/K/p$  (/no particle) plus event/track background.

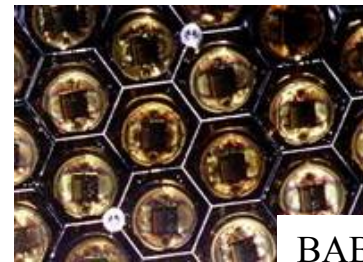
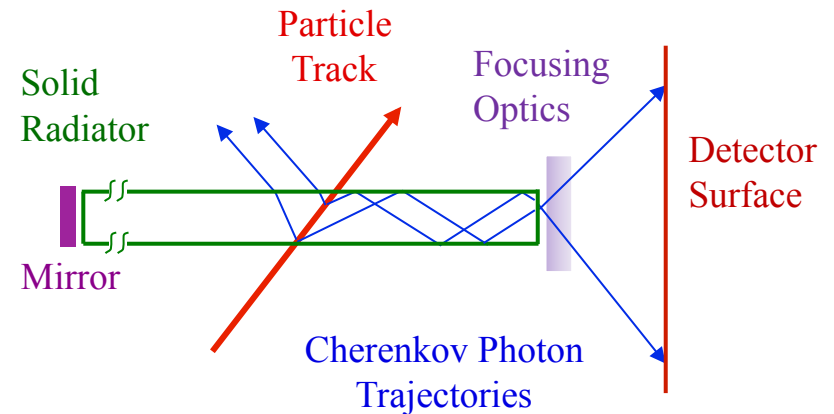

BABAR DIRC

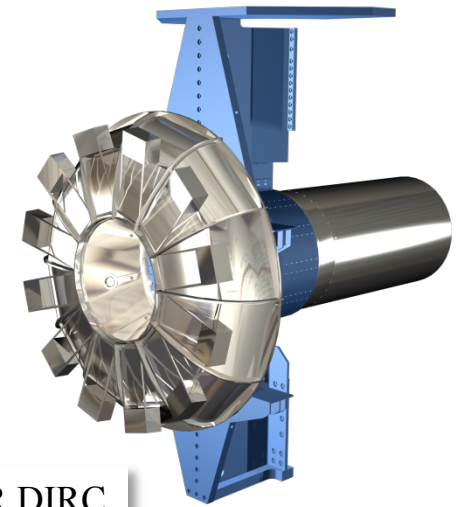

## DIRC detector advantages

- Thin in radius and radiation length.
- Moderate and uniform amount of material in front of EM calorimeter.
- Fast and tolerant of background.
- Robust and stable detector operations.

## PANDA: two DIRC detectors

- **Barrel DIRC** – similar to BABAR DIRC with several improvements.  
PID goal:  $3\sigma$   $\pi/K$  separation for  $p < 3.5$  GeV/c.
- Novel **Endcap Disk (or Disc) DIRC**.  
PID goal:  $3\sigma$   $\pi/K$  separation for  $p < 4$  GeV/c.

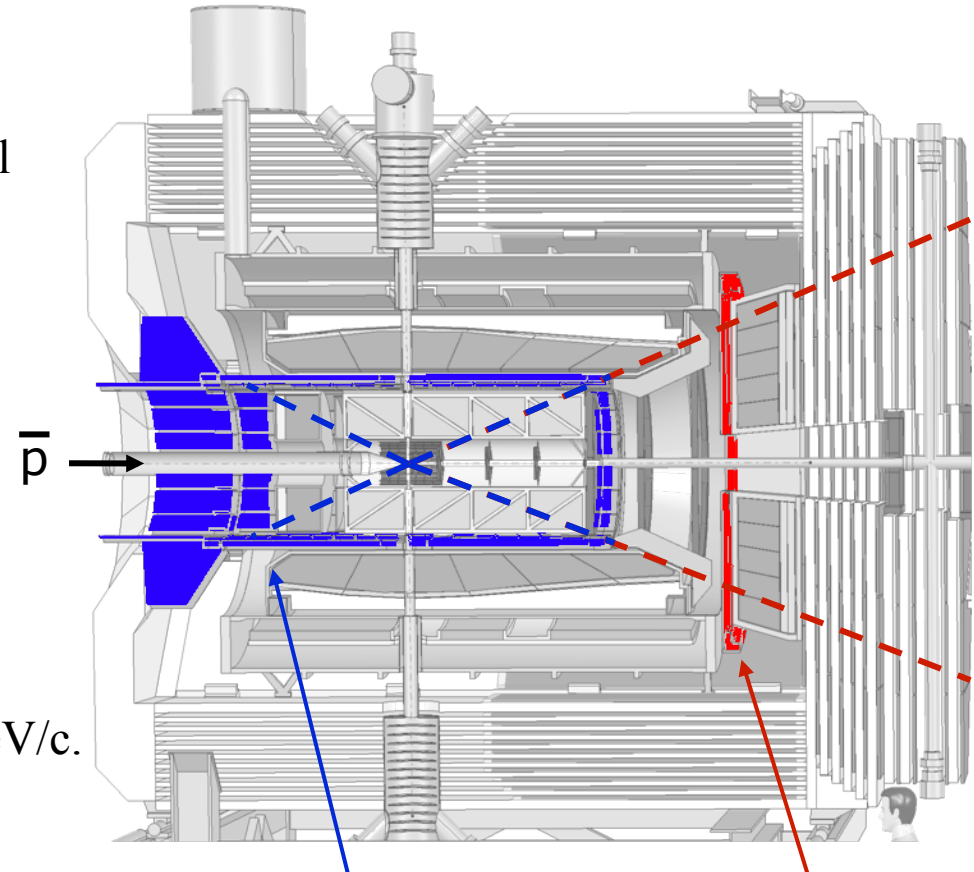

**Barrel DIRC**  
( $22^\circ - 140^\circ$ )

**Endcap Disk DIRC**  
( $5^\circ - 22^\circ$ )

## Institutions currently involved in the two DIRCs

- Dubna, Edinburgh, Erlangen, Gießen, Glasgow, GSI, Mainz, Vienna.

## DIRC detector advantages

- Thin in radius and radiation length.
- Moderate and uniform amount of material in front of EM calorimeter.
- Fast and tolerant of background.
- Robust and stable detector operations.

## PANDA: two DIRC detectors

- **Barrel DIRC** – similar to BABAR DIRC with several improvements.

PID goal:  $3\sigma$   $\pi/K$  separation for  $p < 3.5$  GeV/c.

- Novel **endcap Disk DIRC**.

PID goal:  $3\sigma$   $\pi/K$  separation for  $p < 4$  GeV/c.

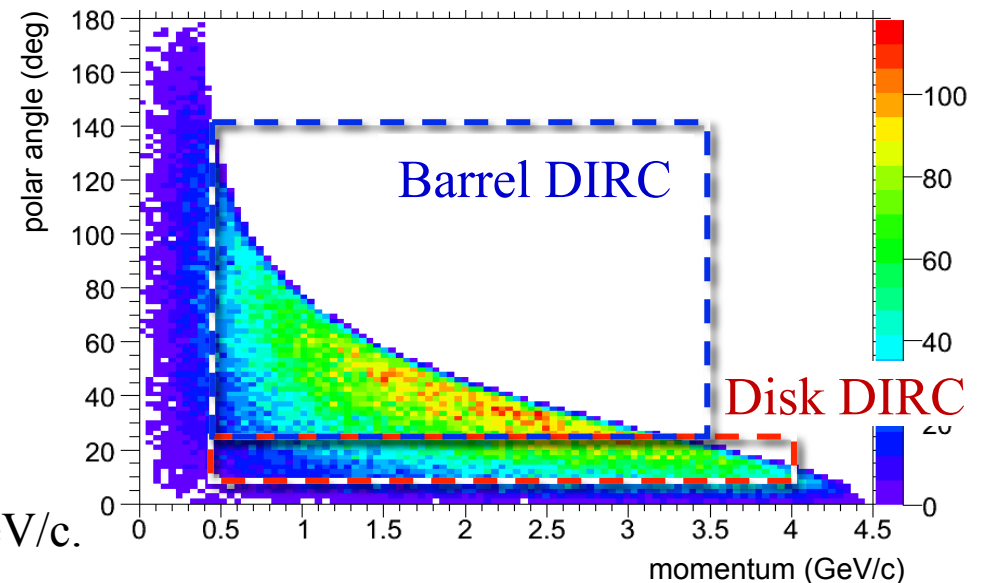

Kaon distribution of the radiative decay

$J/\psi \rightarrow K^+K^- \gamma$   
(search of glue balls)

## Institutions currently involved in the two DIRCs

- Dubna, Edinburgh, Erlangen, Gießen, Glasgow, GSI, Mainz, Vienna.

## Current PANDA Barrel DIRC baseline design:

- Barrel radius  $\sim 50$  cm; expansion volume depth: 30 cm.
- 80 radiator bars, synthetic fused silica  
17mm (T)  $\times$  33mm (W)  $\times$  2500mm (L).
- **Focusing optics:** doublet lens system.
- **Compact photon detector:**  
30 cm oil-filled expansion volume,  
10-15,000 channels of MCP-PMTs.
- **Fast photon detection:**  
fast TDC plus ADC (or ToT) electronics.
- **Expected performance:**  
Single photon Cherenkov angle resolution: 8-9 mrad.  
Number of photoelectrons per track:  $>20$ ;

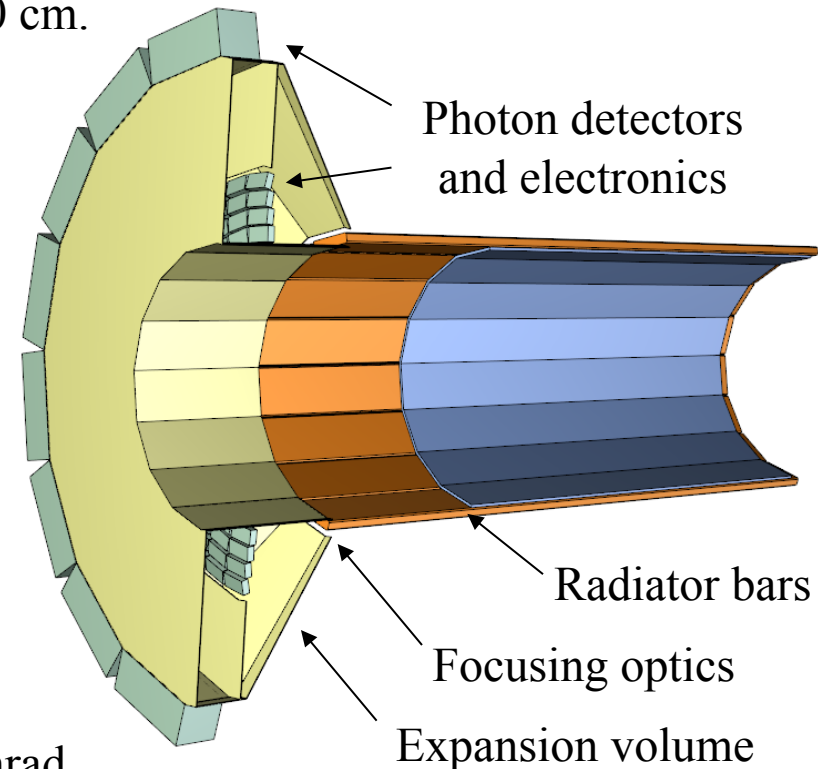

Still investigating several design options:

mirror focusing, radiator plates, photon detection outside magnetic field.



## How do we plan to improve on the successful BABAR-DIRC design for PANDA?

- **Focusing optics:** remove bar size contribution from Cherenkov angle resolution term.  
**Lens doublet and/or mirror focusing on flat detector surface.**

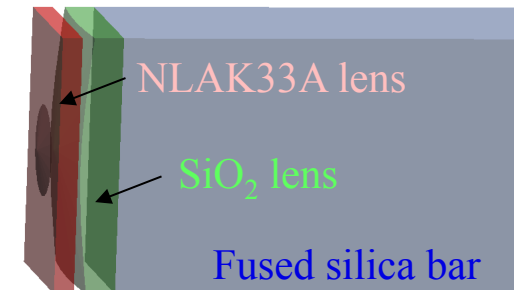

- **Compact multi-pixel photon detectors:**  
 allow smaller expansion region,  
 make DIRC less sensitive to background.  
**MCP-PMTs, MAPMTs, SiPM/G-APD potential candidates.**

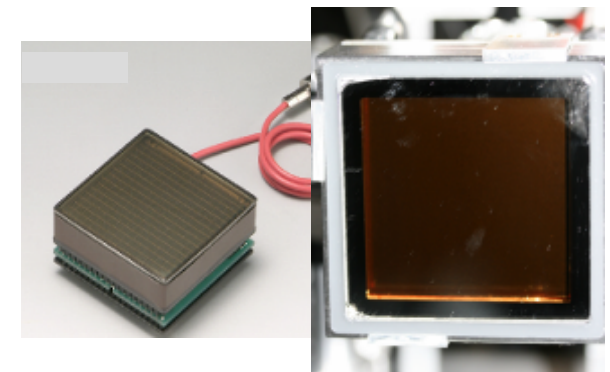

- **Fast photon detection** ( $\sigma_{TTS} \approx 100\text{--}200\text{ps}$ ):  
 software correction of chromatic dispersion.  
**Proof-of-principle shown in 2007**  
**by Focusing DIRC at SLAC.**

(Nucl. Instr. and Meth. Phys. Res. Sect. A 595 (2008) 104-107)

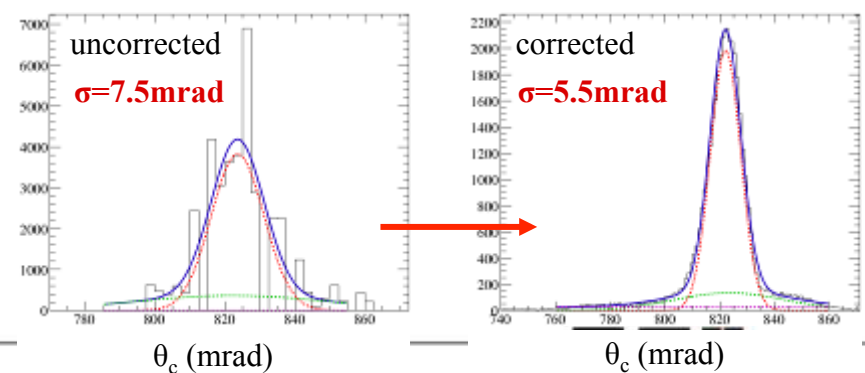

Expected PID performance example.

$$p\bar{p} \rightarrow J/\Psi \Phi \quad \sqrt{s} = 4.4 \text{ GeV}/c^2$$

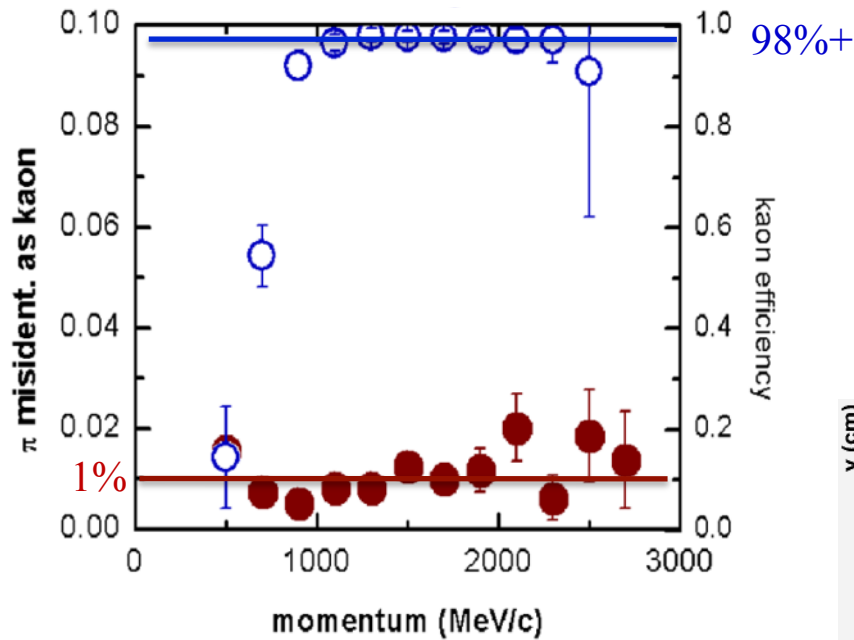

*(Based on early design version.  
Updated study has started.)*

Geant Cherenkov photon tracking in event display.

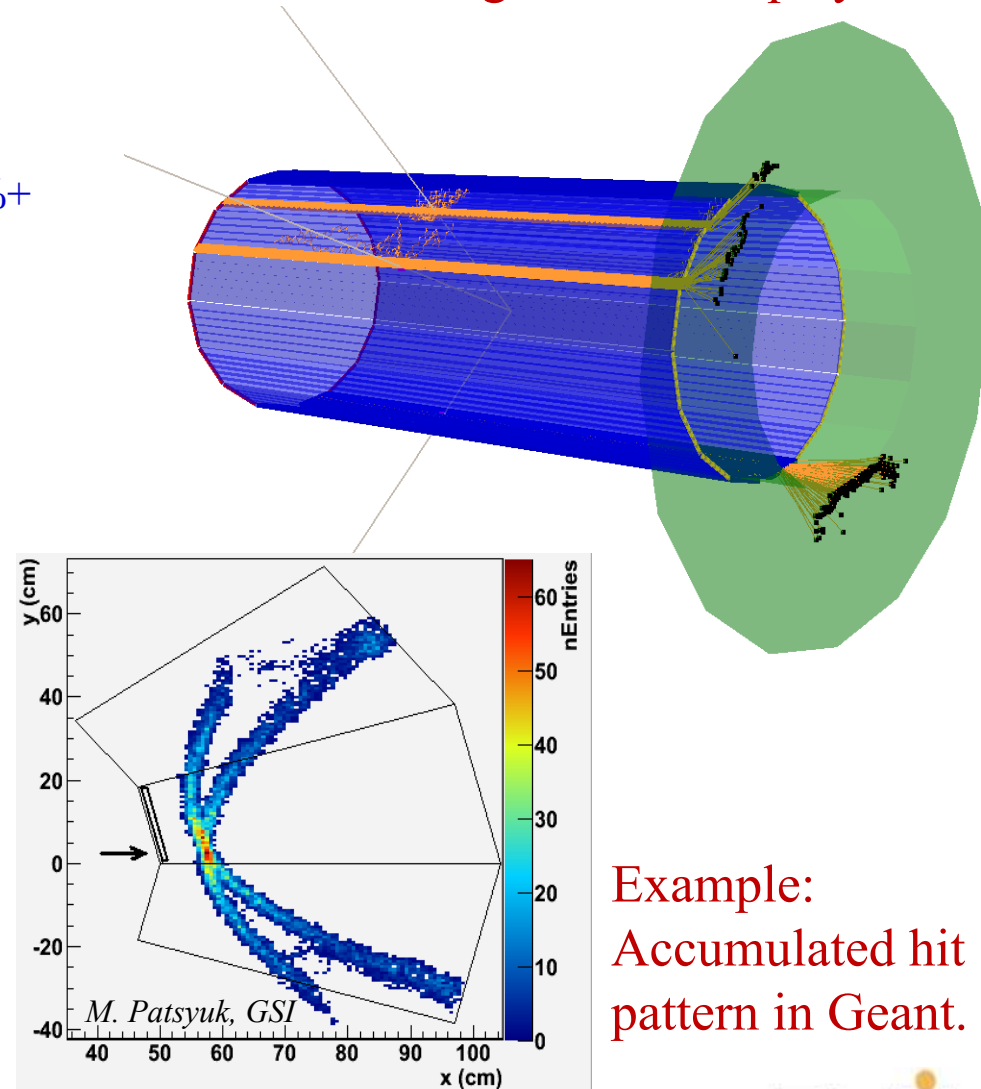

Example:  
Accumulated hit pattern in Geant.

## Current PANDA Disk DIRC baseline design: “3D Disk DIRC”

- Octagonal disk, ~2m diameter, 2cm thick, synthetic fused silica, placed in front of forward calorimeter.
- Disk made from four identical, optically isolated pieces with polished, reflecting sides.
- Dichroic mirrors on rim serve as optical band-pass filters (dispersion mitigation).
- 432 small focusing light guides image photons on digital SiPM or MCP-PMT.

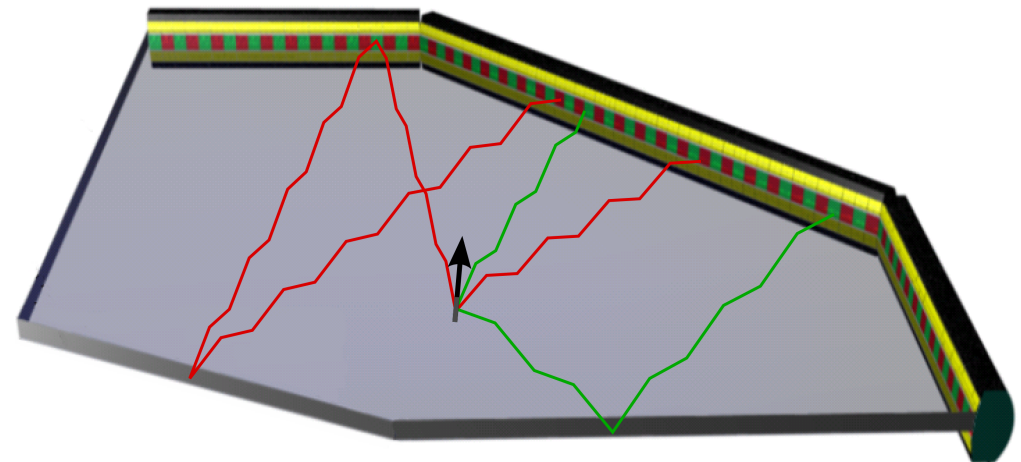
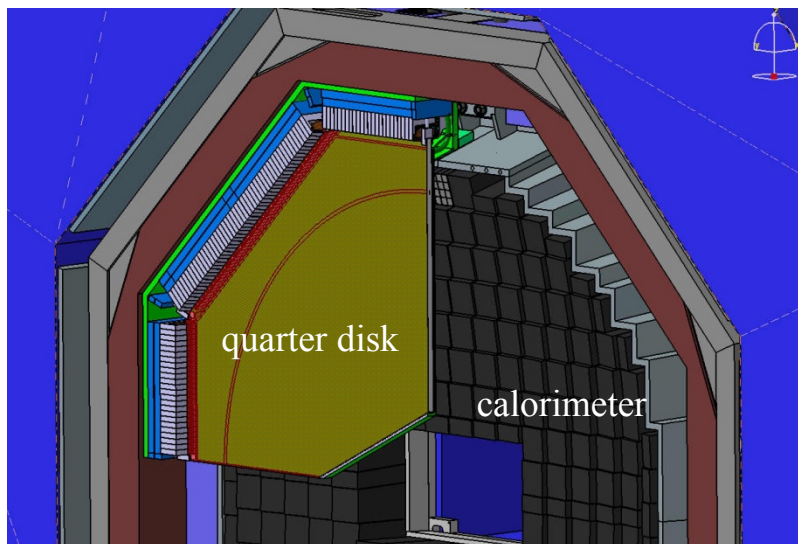
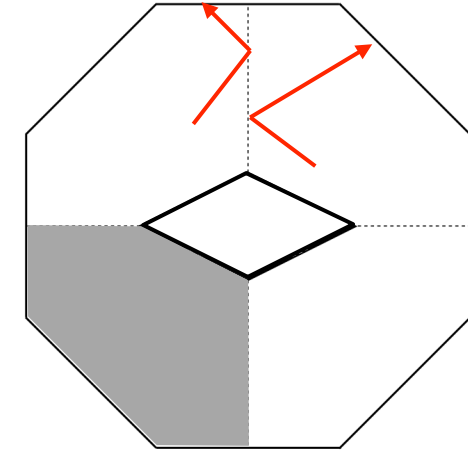

- Fast and small pixel detectors: dSiPMs or MCP-PMTs
- Two  $2 \times 2$  dSiPM arrays (or 2 MCP) per light guide.
- Two types of dichroic mirrors: 400-500nm, 500-700nm, alternating along rim.
- Angle measurement using small focussing light guides and multi-pixel detectors.
- Time-of-Propagation measurement using the light guides and fast photo detectors.

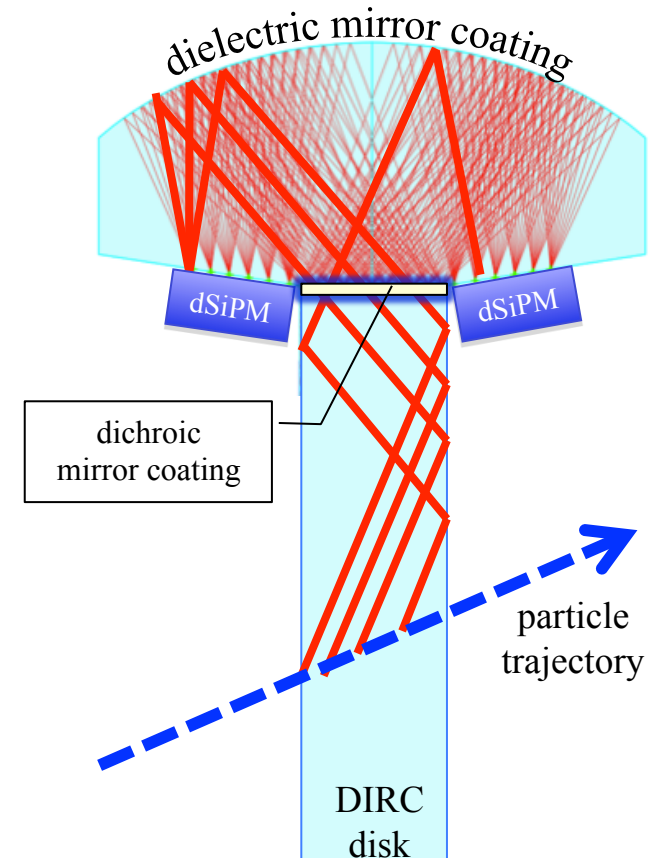
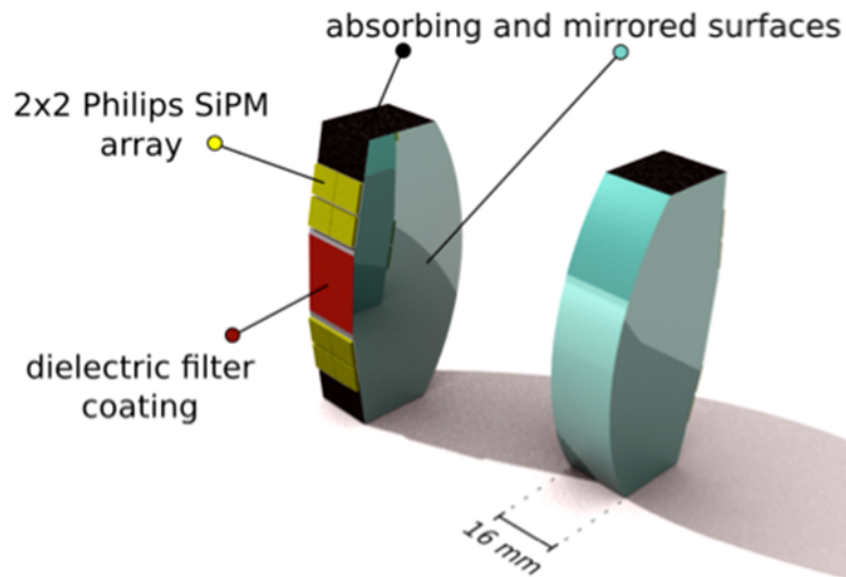

3D hit pattern looks complicated but...

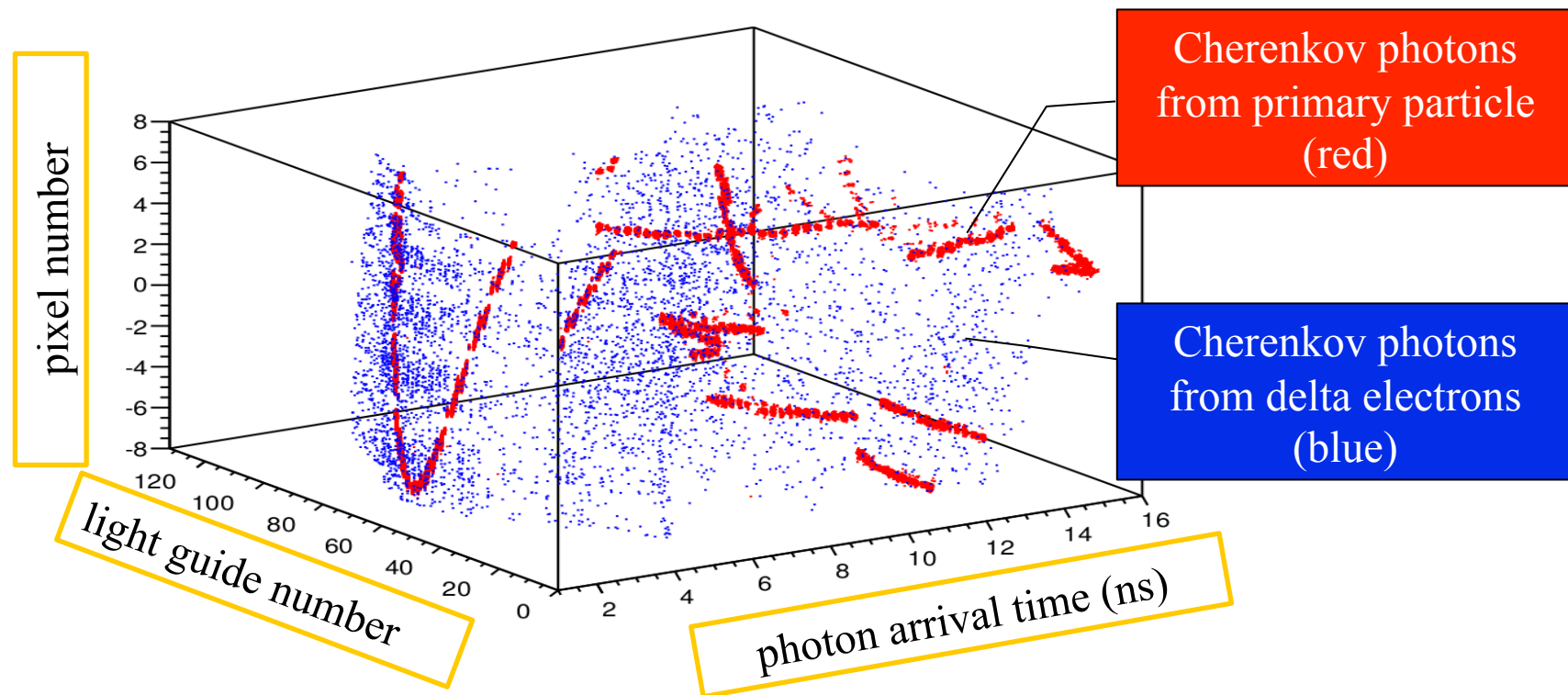

... signal/background separation much easier and robust in 3 dimensions than in a 2-dimensional projection.

Full 3D Geant simulation of geometry, photon generation, and photon propagation.

Red: photons emitted by primary particle (100 identical tracks).

Green: Pattern prediction generated by the reconstruction method.

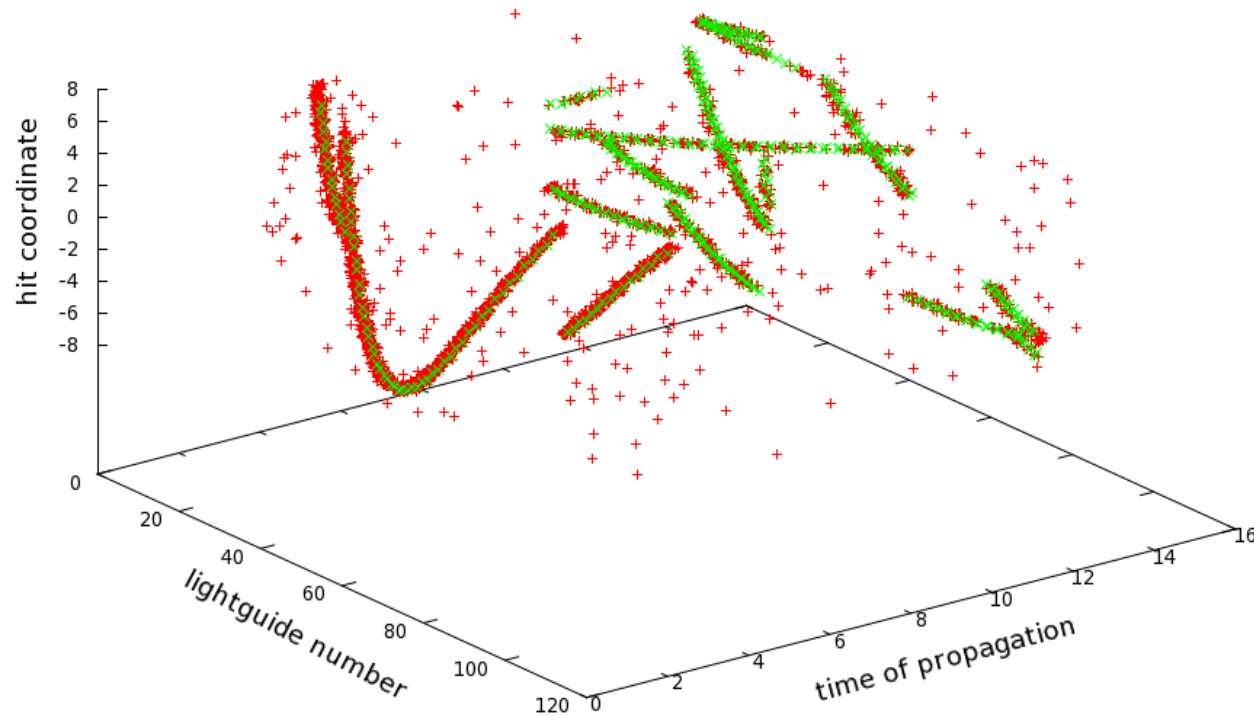

Reconstruction algorithm robust, background-tolerant.

Preliminary performance study shows pion/kaon mis-ID rate at 4GeV/c at 1-2% level.

## Investigating design alternatives: “Focusing Light Guide DIRC”

- 128-sided polygonal disk, glued from six pieces  
(→ *disk shape, gluing*).
- LiF block glued to rim of synthetic fused silica disk  
(→ *dispersion mitigation*).
- Focusing light guides image photons on MCP-PMTs  
(→ *light guide shape, sensor and readout technology*).

*synthetic fused silica disk and light guide*

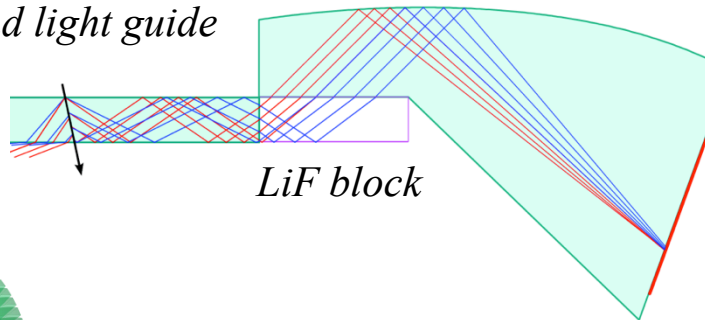

*LiF block*

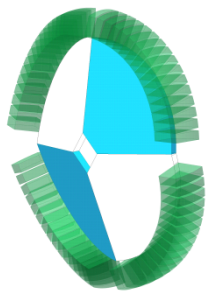

*CEARA*

Will be able to test a simplified design in an experiment very soon:  
Focusing Light Guide DIRC (CEARA) for WASA at COSY (FZ Jülich).

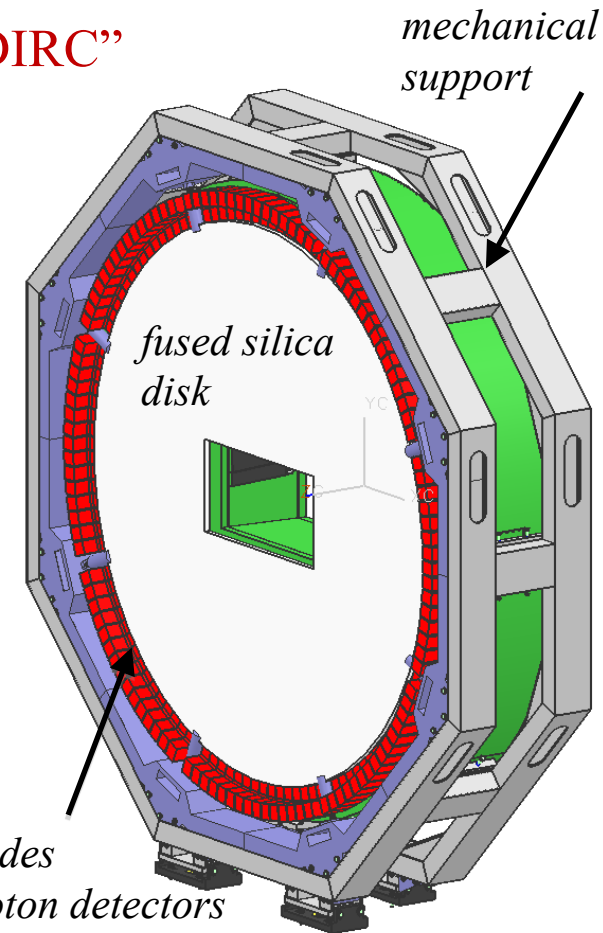

*mechanical support*

*fused silica disk*

*lightguides and photon detectors*

## PANDA DIRCs are asking a lot of fast compact multi-pixel photon detectors

- Single photon sensitivity, low dark count rate;
- Reasonably high photo detection efficiency;
- Fast timing:  $\sigma_{TTS} \approx 50-100$  ps (Barrel: 100-200 ps);
- Few mm position resolution;
- Operation in up to 1.5 T (Barrel:  $\sim 1$  T) magnetic field;
- Tolerate high rates up to 2 MHz/cm<sup>2</sup> (Barrel: 0.2 MHz/cm<sup>2</sup>);
- Long lifetime: 4-10 C/cm<sup>2</sup> per year at 10<sup>6</sup> gain (Barrel: 0.5 C/cm<sup>2</sup>/yr).

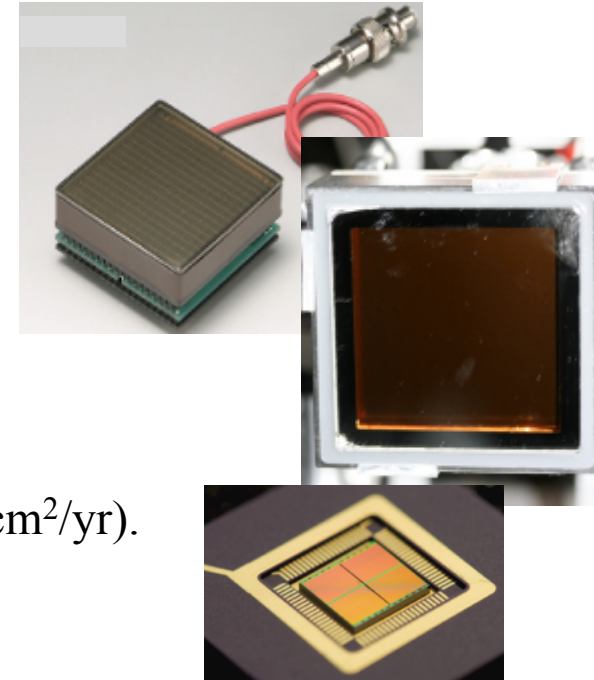

No currently available sensor matches all criteria;  
promising candidates: MCP-PMTs, MAPMTs, SiPM.

Starting ageing test of two very new enhanced lifetime MCP-PMTs side-by-side:  
Hamamatsu SL-10 and Burle XP85112 – both may be (almost) acceptable for barrel DIRC.

Digital SiPM (Philips) promising sensor for Disk: excellent timing and lifetime, integrated readout electronics, masking of hot pixels.

But: needs cooling, needs redesign for single photons, new technology, prototypes only.



## Electronics design demanding

- Signal rise time typically few hundred picoseconds.
- 10-100x preamplifier usually needed.
- High bandwidth 500MHz – few GHz (optimum bandwidth not obvious).
- Pulse height information required for  $< 100$  ps timing (time walk correction),  
and desirable for 100-200 ps timing (ADC / time over threshold / waveform sampling / ... )
- PANDA will run trigger-less.
- Large data volume (Disk: up to 200 Gb/s).
- Example:  
HADES TRB board with NINO TOF add-on in GSI test beam in 2009, updated TOF add-on in test beams at GSI (next week) and at CERN in July.
- Significant development effort ahead.
- dSiPM with digitization on chip – no TDC, preamp, ADC, etc development required.

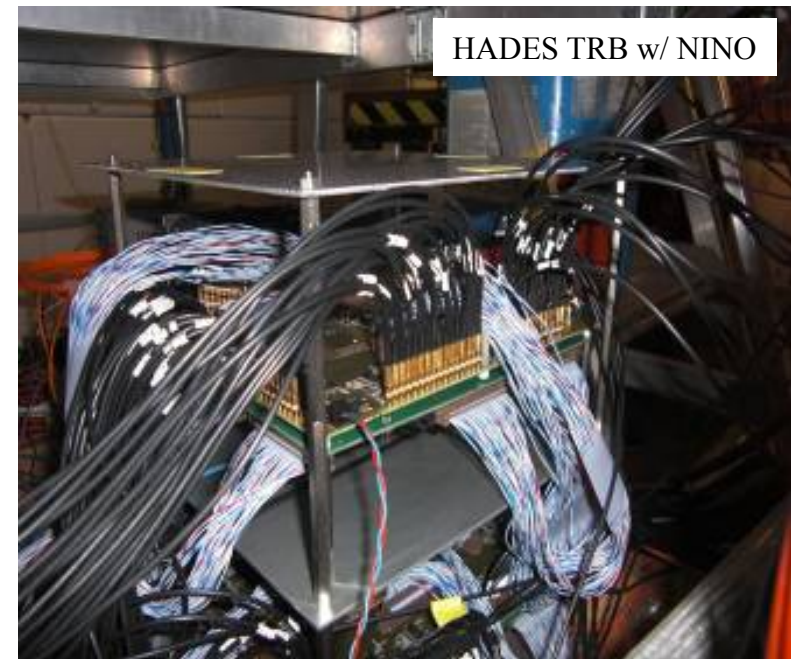

Production of large fused silica pieces (bars, plates, disk segments) is challenging.

DIRCs require **mechanical tolerances** on flatness, squareness, and parallelism with **optical finish** and long sharp edges.

→ difficult, potentially expensive, few qualified vendors worldwide.

BABAR-DIRC used bars polished to  $5 \text{ \AA rms}$ , non-squareness  $< 0.25 \text{ mrad}$ ; successfully done for BABAR, need to qualify/retrain vendors 10+ years later.

Can afford to relax some of those specs for PANDA DIRCs due to shorter photon paths (surface roughness  $10\text{-}20 \text{ \AA rms}$ , non-squareness  $0.5\text{-}1 \text{ mrad}$ , etc).

Identified several good candidates for synthetic fused silica material (Heraeus, Corning).

Have been working with potential vendors in Europe and USA, obtained/ordered prototype bars, plates, disk segments from several companies, verifying surfaces and angles.

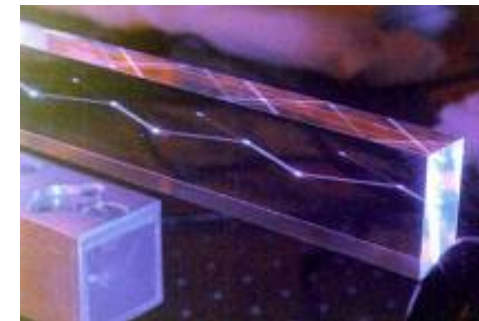

Successful beam tests of PANDA  
Cherenkov prototypes, GSI, Sep 2009

2 GeV protons

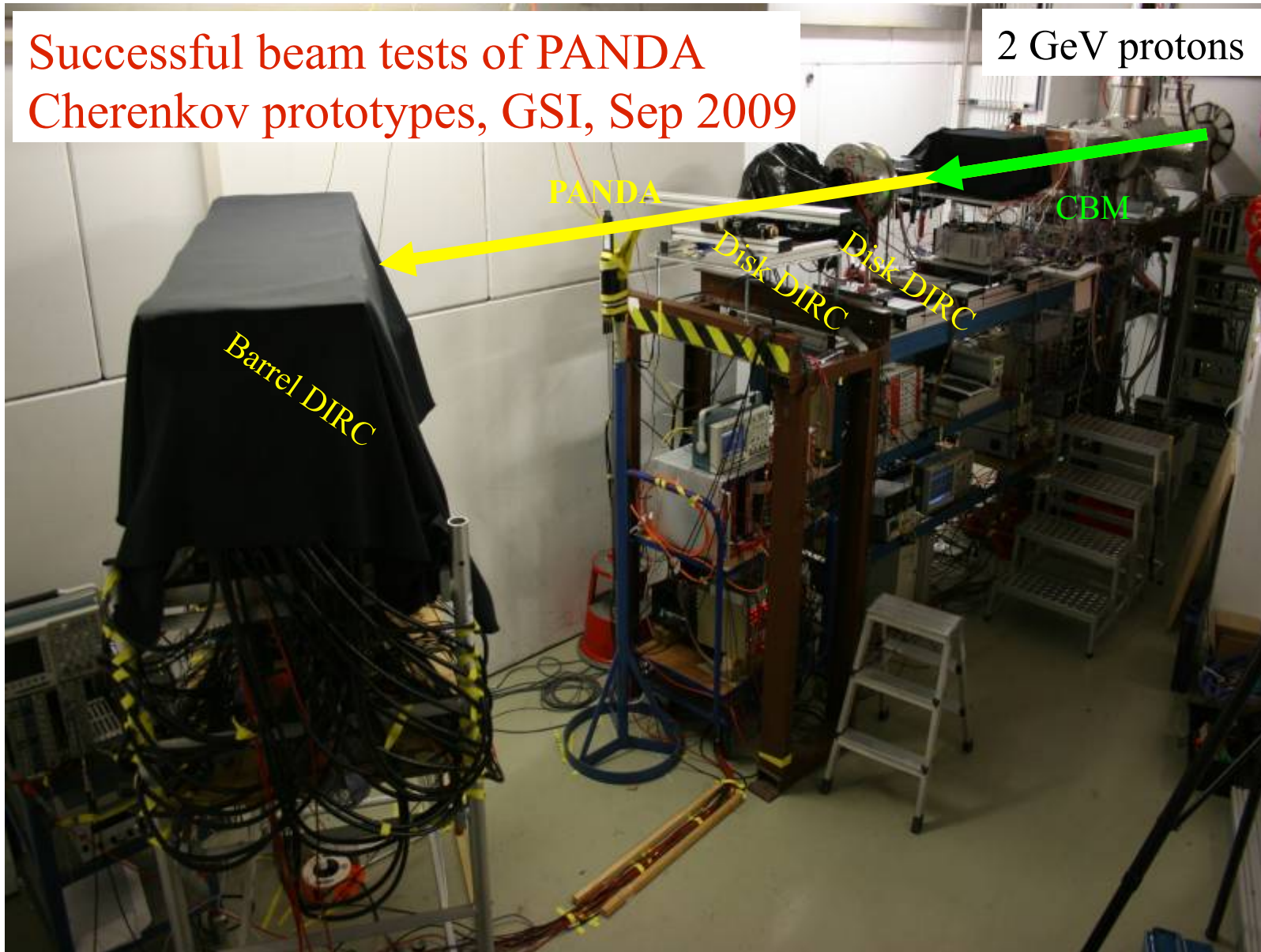

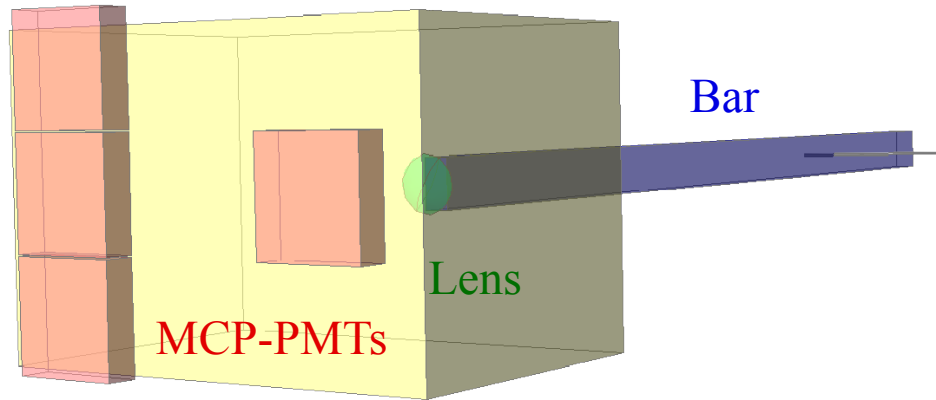

**Barrel DIRC Prototype**  
in proton test beam at GSI

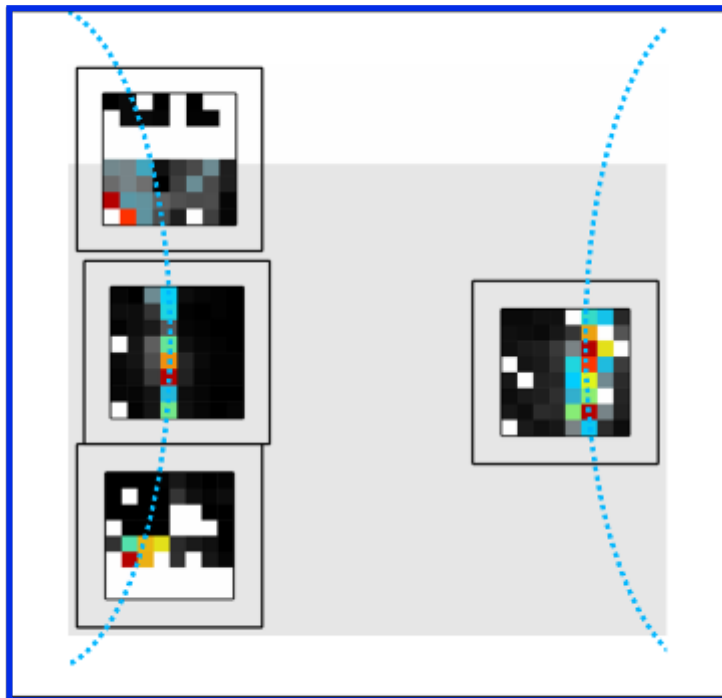
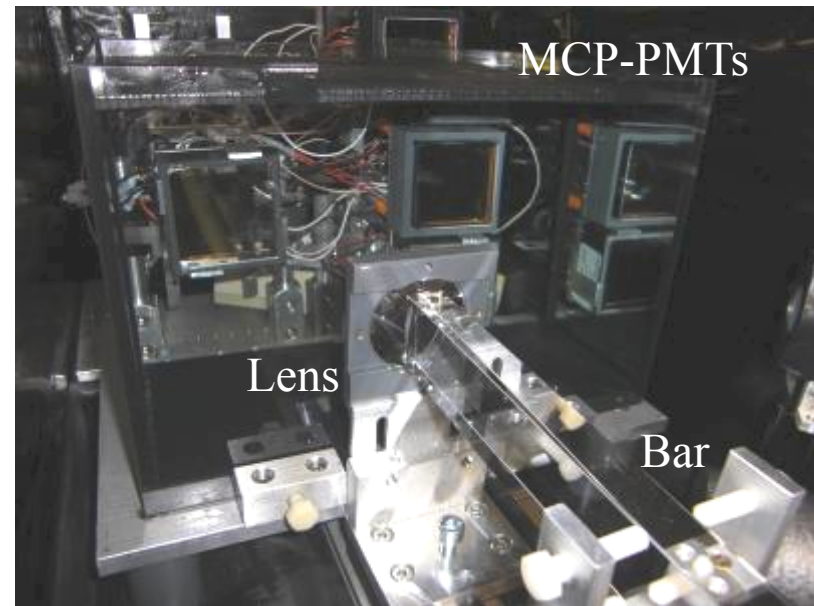

Cherenkov Ring segments  
observed in Aug/Sep 2009

## New Barrel DIRC Prototype

- Larger, deeper expansion volume.
- Larger detector plane, space for more sensors.
- 640 electronics channels (HADES TRB/NINO)
- Focusing lenses with different AR coatings.

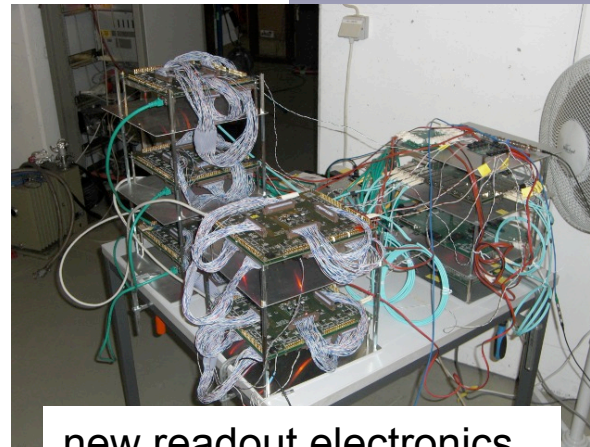
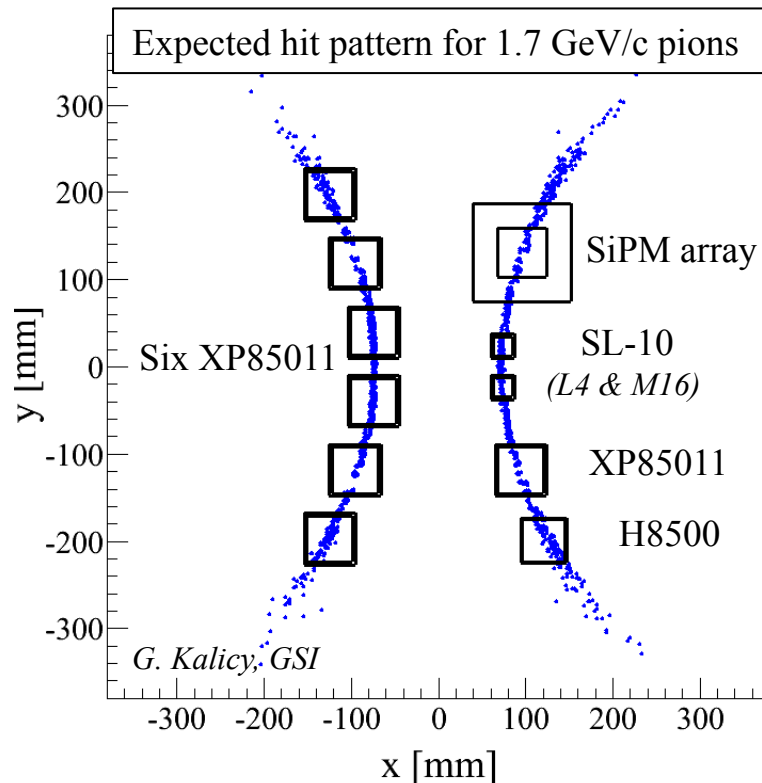
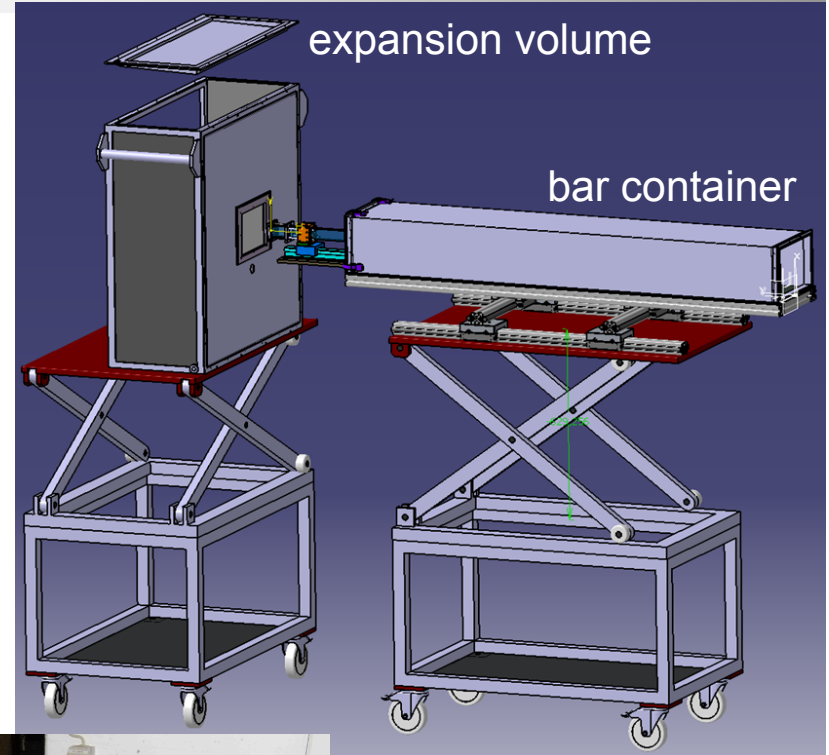

new readout electronics moved to cave yesterday

Getting ready for test beam on Tuesday.

Several test beam campaigns since 2008 to test focusing light guides, photon yield and light transmission in bulk material, performance of SiPM/dSiPM sensors.

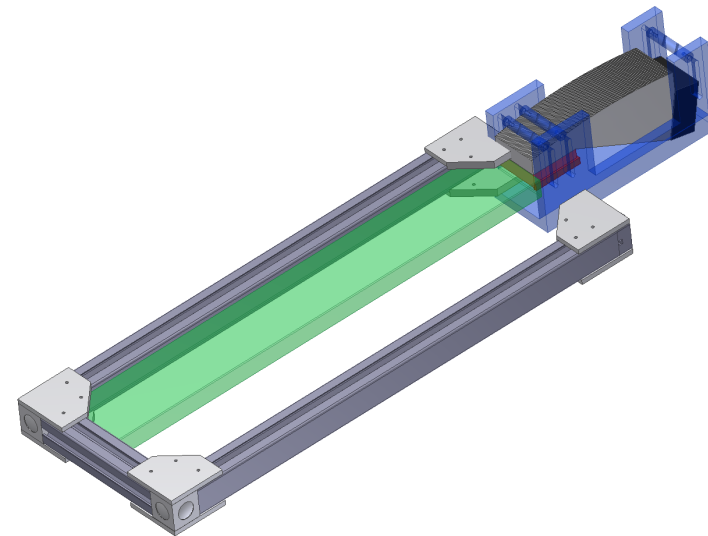
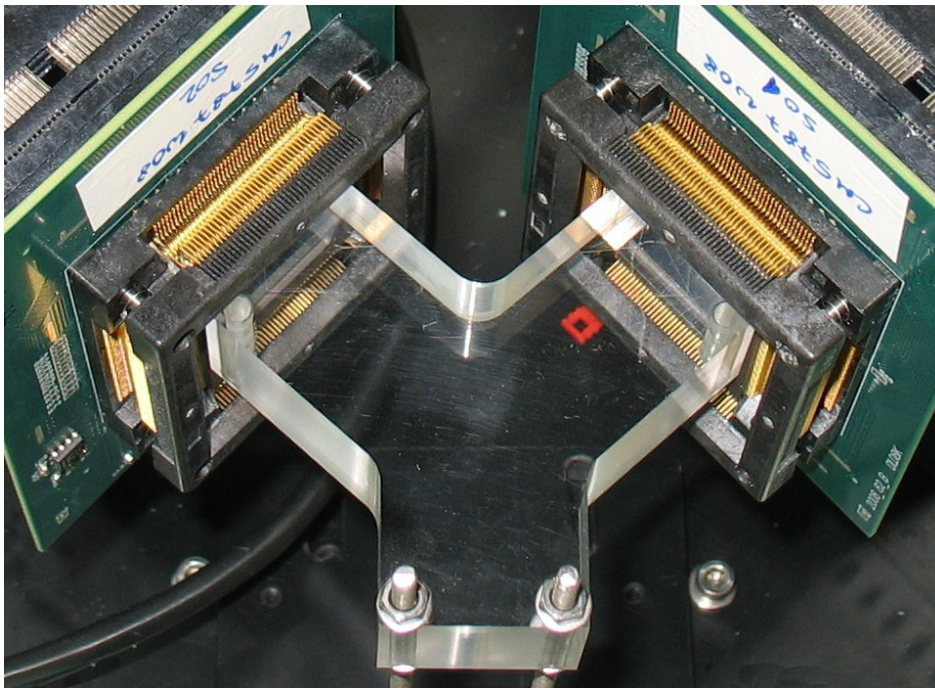
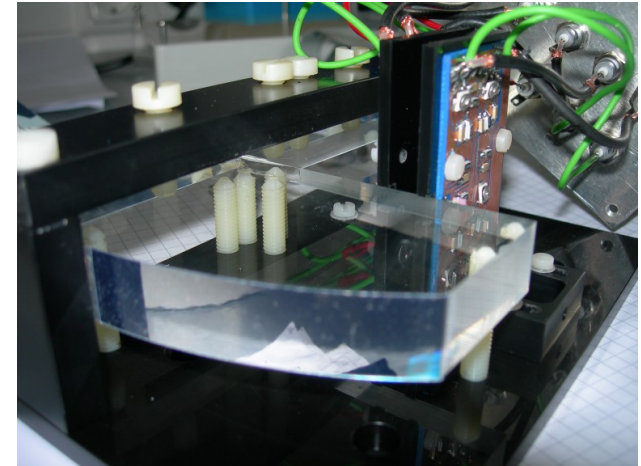

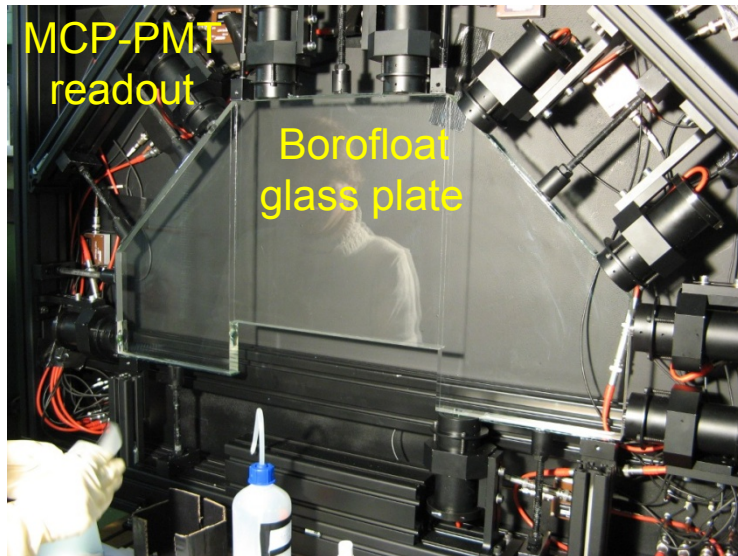

## Protoype at DESY

glued glass plate  
(~40% scale)

Sensors: 9 MCP-PMTs  
studied timing, paths



## Simulated photon paths

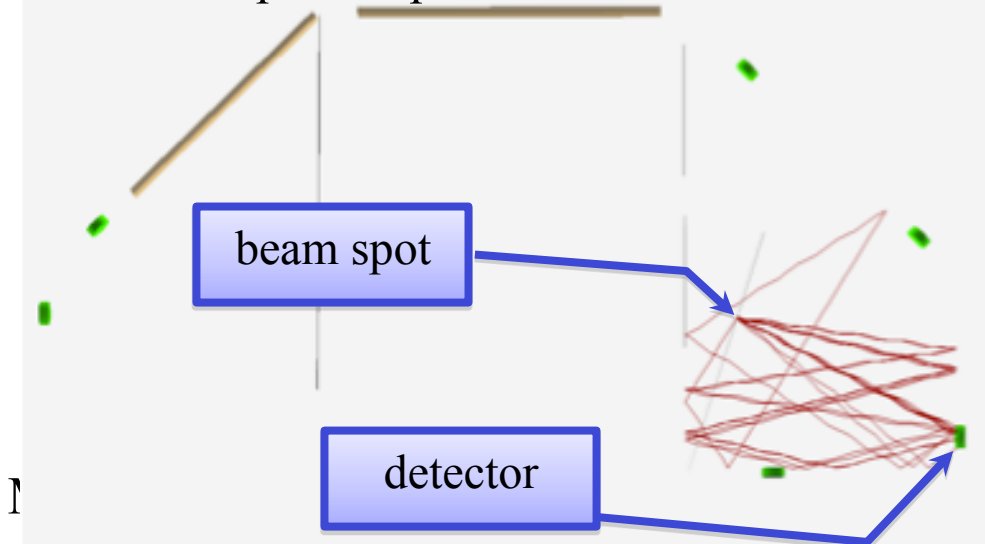

measured vs. expected time of propagation

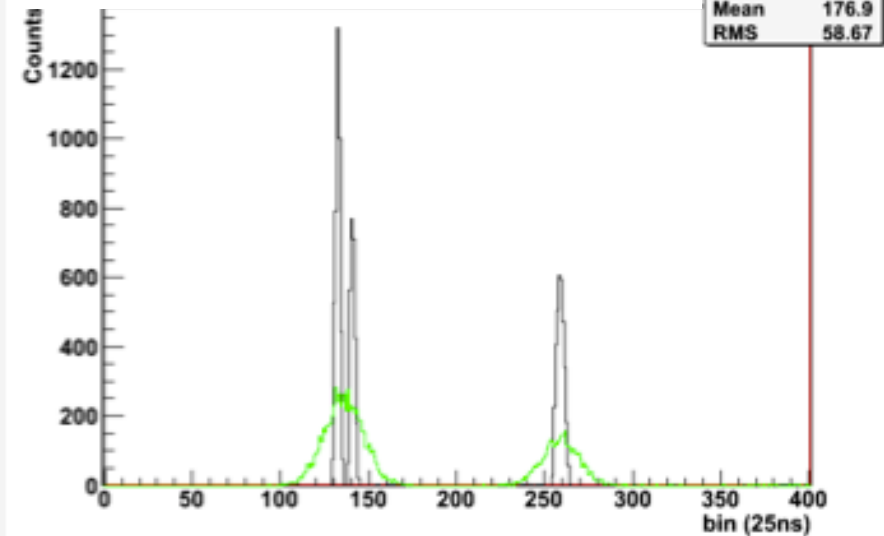

**PANDA target spectrometer design includes two DIRC detectors for hadronic PID:**

**Barrel DIRC:** fast focusing DIRC inspired by BABAR-DIRC;

**Endcap Disk DIRC:** fast plate DIRC, first of its kind, several viable designs.

**R&D activities:** photon detectors, readout electronics, radiator quality, focusing optics, fast timing, chromatic correction, simulation, reconstruction, and more.

Key challenges:

- **Pico-second timing** with single photons in environment with 1-10 C/cm<sup>2</sup>/yr and 1-1.5 T.  
→ Discussing solutions with industry, testing prototypes in lab.
- **Cherenkov radiator** (bars, plates, disk) production and assembly.  
→ In contact with vendors in Germany, Russia, USA, testing prototype pieces.
- **Design** of detector optics and reconstruction software.  
→ Developing simulation framework (Geant and ray-tracing).

Validating technology and design choices in test beams.

FAIR construction to start within the year, DIRC installation planned 2016/2017.



Thanks to the organizers for the opportunity to give this talk.

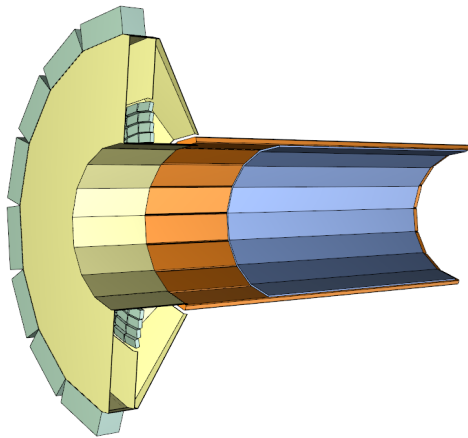

G. Ahmed<sup>1</sup>, A. Britting<sup>2</sup>, P. Bühler<sup>1</sup>, E. Cowie<sup>3</sup>,  
 V. Kh. Dodokhov<sup>4</sup>, M. Düren<sup>5</sup>, D. Dutta<sup>6,a</sup>,  
 W. Eyrich<sup>2</sup>, K. Föhl<sup>5</sup>, D. I. Glazier<sup>7</sup>,  
 A. Hayrapetyan<sup>5</sup>, M. Hoek<sup>3</sup>, R. Hohler<sup>6</sup>,  
 A. Lehmann<sup>2</sup>, D. Lehmann<sup>6</sup>, R. Kaiser<sup>3</sup>, T. Keri<sup>3</sup>,  
 P. Koch<sup>5</sup>, B. Kröck<sup>5</sup>, J. Marton<sup>1</sup>, O. Merle<sup>5</sup>,  
 R. Montgomery<sup>3</sup>, K. Peters<sup>6</sup>, S. Reinicke<sup>2</sup>,  
 G. Rosner<sup>3</sup>, B. Roy<sup>6,a</sup>, G. Schepers<sup>6</sup>, L. Schmitt<sup>6</sup>,  
 C. Schwarz<sup>6</sup>, J. Schwiening<sup>6</sup>, B. Seitz<sup>3</sup>,  
 C. Sfienti<sup>6,b</sup>, K. Suzuki<sup>1</sup>, F. Uhlig<sup>2</sup>,  
 A. S. Vodopianov<sup>4</sup>, D. P. Watts<sup>7</sup>, W. Yu<sup>5</sup>

<sup>1</sup> Stefan Meyer Institut für subatomare Physik, Austrian Academy of Sciences, A-1090 Vienna, Austria.

<sup>2</sup> Physikalisches Institut Abteilung IV, University of Erlangen-Nuremberg, D-91058 Erlangen, Germany.

<sup>3</sup> Department of Physics & Astronomy, Kelvin Building, University of Glasgow, Glasgow G12 8QQ, United Kingdom.

<sup>4</sup> Laboratory of High Energies, Joint Institute for Nuclear Research, 141980 Dubna, Russia.

<sup>5</sup> II. Physikalisches Institut, University of Giessen, D-35392 Giessen, Germany.

<sup>6</sup> GSI Helmholtzzentrum für Schwerionenforschung GmbH, Planckstrasse 1, 64291 Darmstadt, Germany.

<sup>7</sup> School of Physics, University of Edinburgh, Edinburgh EH9 3JZ, United Kingdom.

<sup>a</sup> present address: Nuclear Physics Division, Bhabha Atomic Research Centre, Mumbai, India 400085.

<sup>b</sup> present address: Institut für Kernphysik, University of Mainz, D-55128 Mainz, Germany.

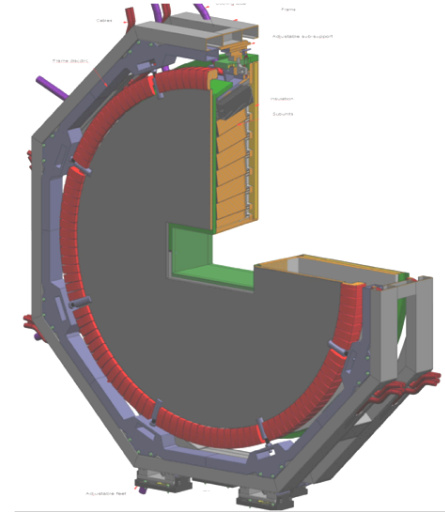

And thank you all for your attention.

# EXTRA TRANSPARENCIES

DIRC technology good match to Particle Identification requirements at PANDA.

At least 3 standard deviations  $\pi/K$  separation from 0.5 GeV/c up to 4-5 GeV/c.

DIRC detectors are thin in radial dimension and in radiation length.

Important for E.M. calorimeters down-stream from PANDA DIRCs.

BABAR-DIRC: barrel geometry, successful, robust, easy to operate.

Future DIRCs:

- PANDA and SuperB:  
BABAR-type barrel geometry using bars, improving on BABAR compact, focusing optics, 5-10 $\times$  faster time measurement.
- Belle-II:  
Barrel geometry using plates, focusing, fast timing.
- PANDA Endcap Disk DIRC: first DIRC using disk geometry multiple designs being considered in PANDA.

Excellent synergy with WASAatCOSY (Jülich)

(simplified version of Disk DIRC, validate PANDA design choices).

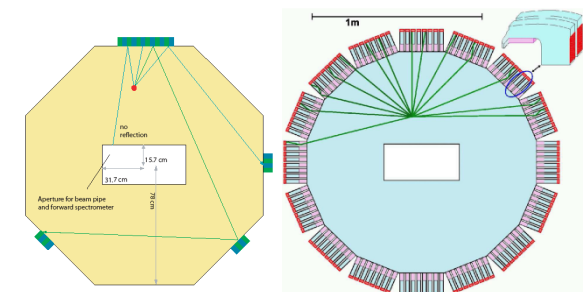
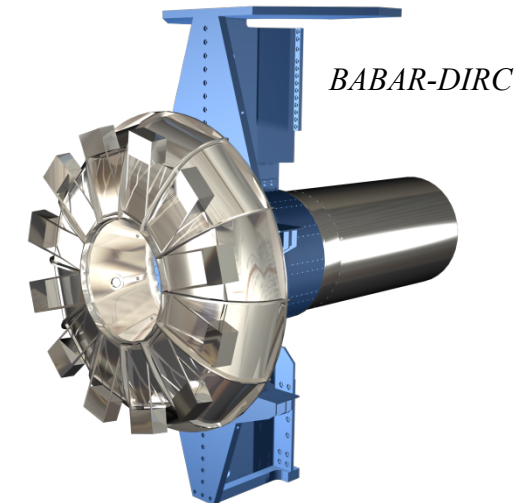

## Novel forward/endcap PID detector concept – first disk DIRC.

- **Focusing optics:** remove bar size contribution from Cherenkov angle resolution term.

Focusing light guide.

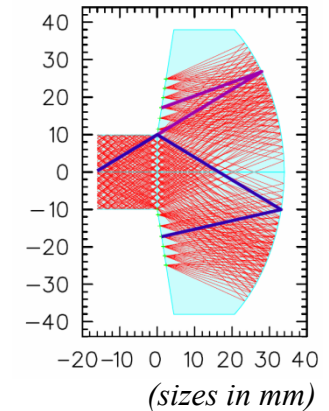

- **Compact, fast multi-pixel photon detectors:** allow very small light guide (expansion region), excellent timing to suppress event/track background.

SiPM or MCP-PMTs potential candidates.

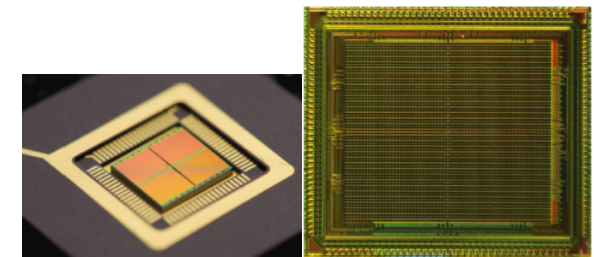

- **Dispersion correction:** hardware correction of chromatic dispersion.

Dichroic mirrors (optical band-pass filters) or

LiF block corrects angle of transmitted photons.

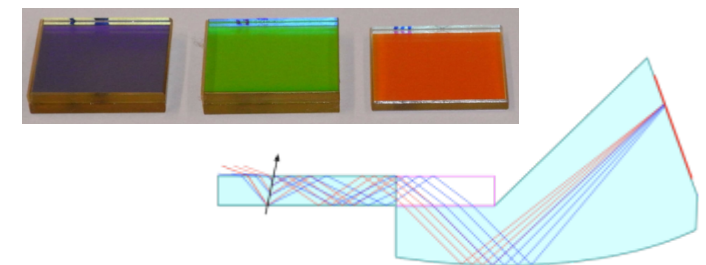

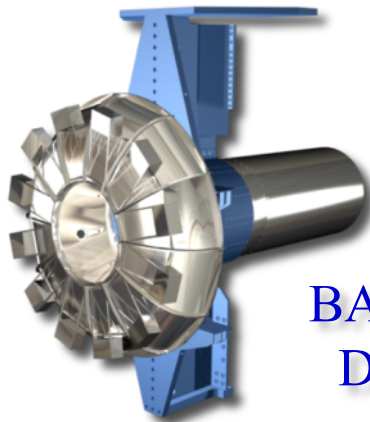

BABAR  
DIRC

First of its kind – excellent performance, easy to operate,  
essential ingredient in most BABAR publications.

... plus CEARA @ WASA  
TORCH @ LHCb, ...

## Belle II TOP

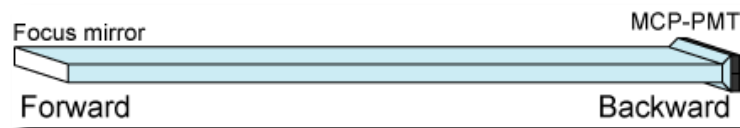

First DIRC with plate geometry.  
Cherenkov angle from excellent  
timing plus 2 coarse space points.

## PANDA DIRCs

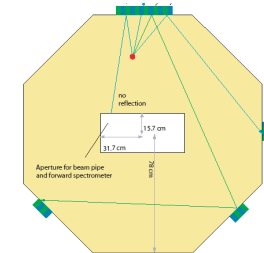
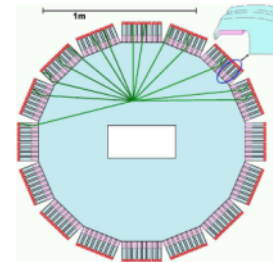
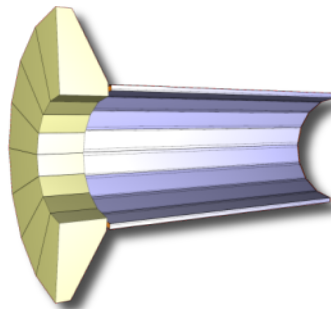

Barrel DIRC: focusing, compact version of BABAR DIRC.

Disk DIRC: first endcap DIRC, design decision soon.

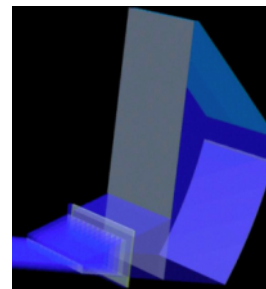

## SuperB FDIRC

Focusing optics and fast timing  
using existing BABAR DIRC bars.  
Cherenkov angle from space points,  
timing for chromatic correction.

# PANDA DIRC R&D

## Rate Stability

A. Lehmann,  
RICH 2010

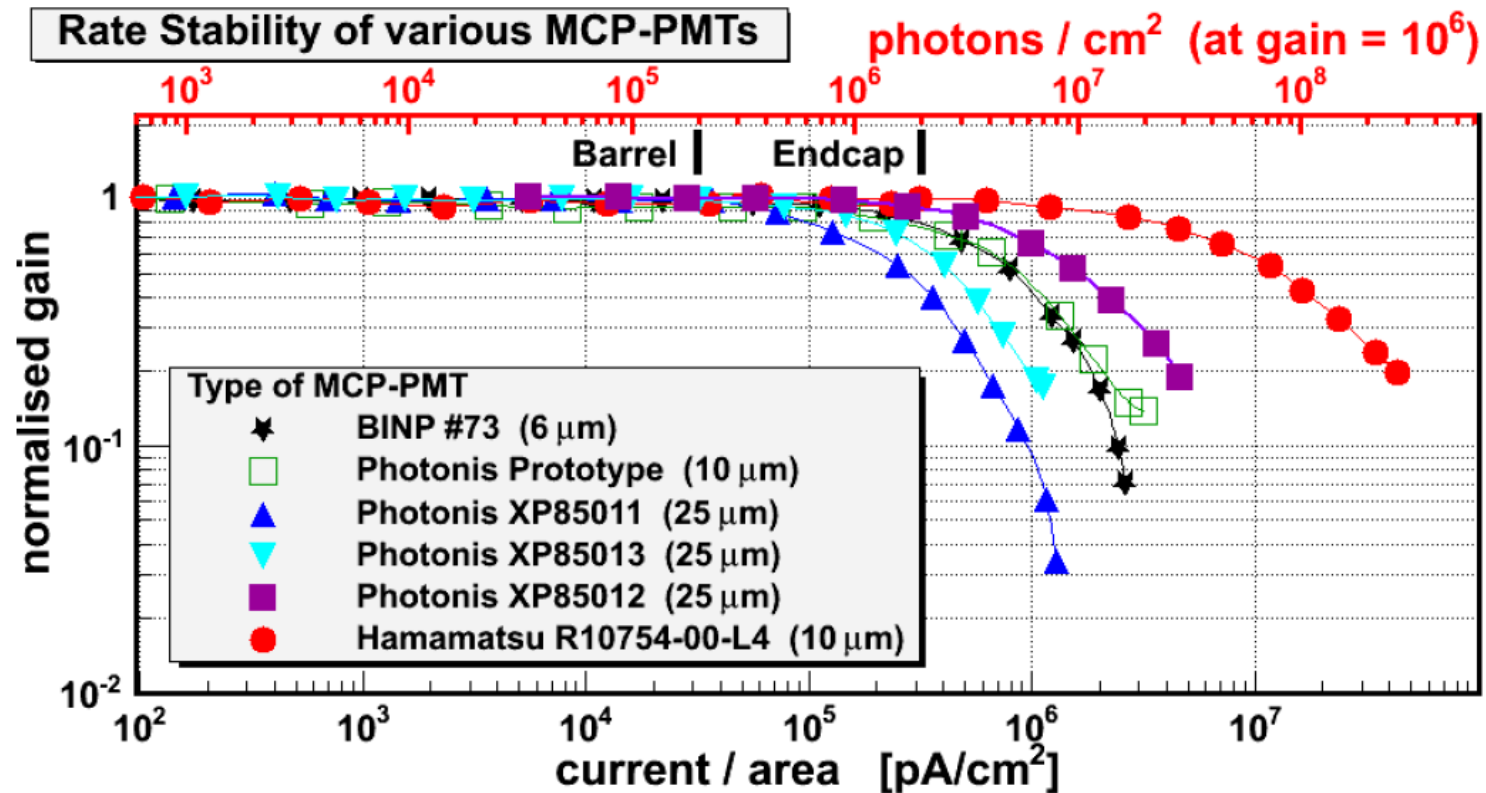

- most MCP-PMTs show stable operation to  $\sim 200\text{-}300$  kHz/cm<sup>2</sup> single photons (at gain 10<sup>6</sup>)
- **R10754 and XP85012** seem suitable for both PANDA DIRCs

	Barrel DIRC	Endcap DIRC	XP85012	R10754
Gain [ $\cdot 10^6$ ]	> 0.5 @ 1 T	> 0.5 @ 2 T	barrel ok	endcap ok
Time resolution [ps]	< 100	< 50	37	32
Rate stability [MHz/cm <sup>2</sup> ]	0.2	2	> 1	> 5
Lifetime [C/cm <sup>2</sup> /year]	~ 1	4 – 10	barrel in reach	w. prot. layer: maybe endcap in reach

A. Lehmann,  
RICH 2010

- Latest models of MCP-PMTs fulfil most specifications for PANDA DIRC except lifetime.
- Recent developments have increased lifetime of MCPs significantly, but further improvements will be needed.

For barrel DIRC we have a **fallback solution**: extend barrel through magnet yoke and place MaPMT photon detector **outside magnetic field** (like BABAR).  
Expensive solution that would have significant negative impact on rest of PANDA.



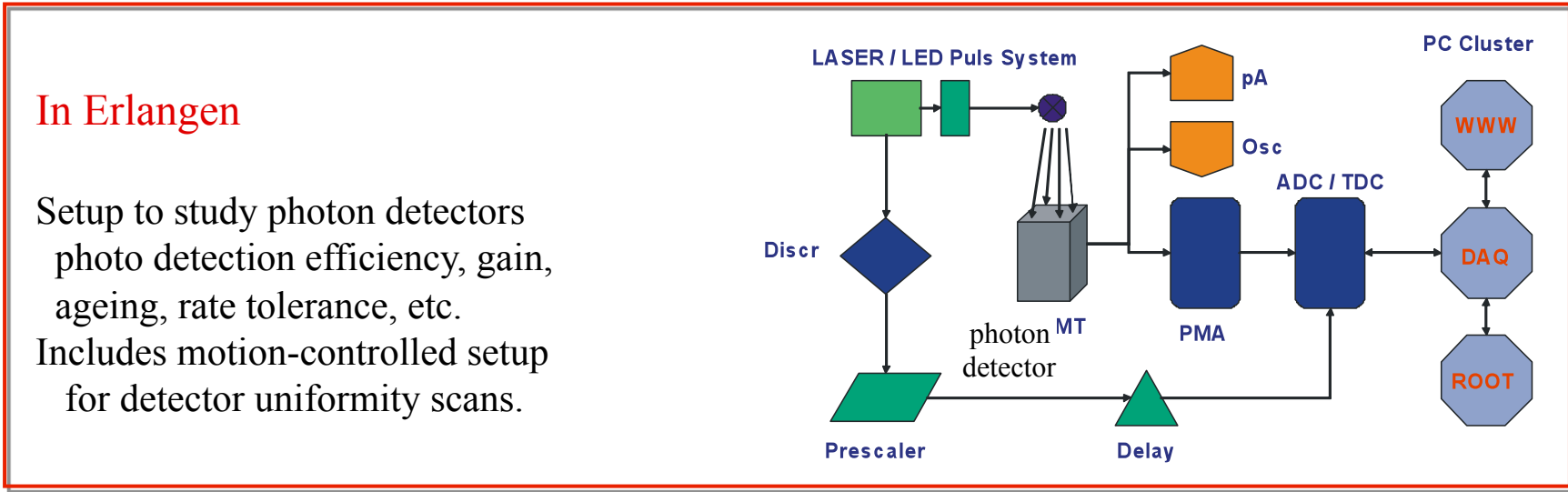
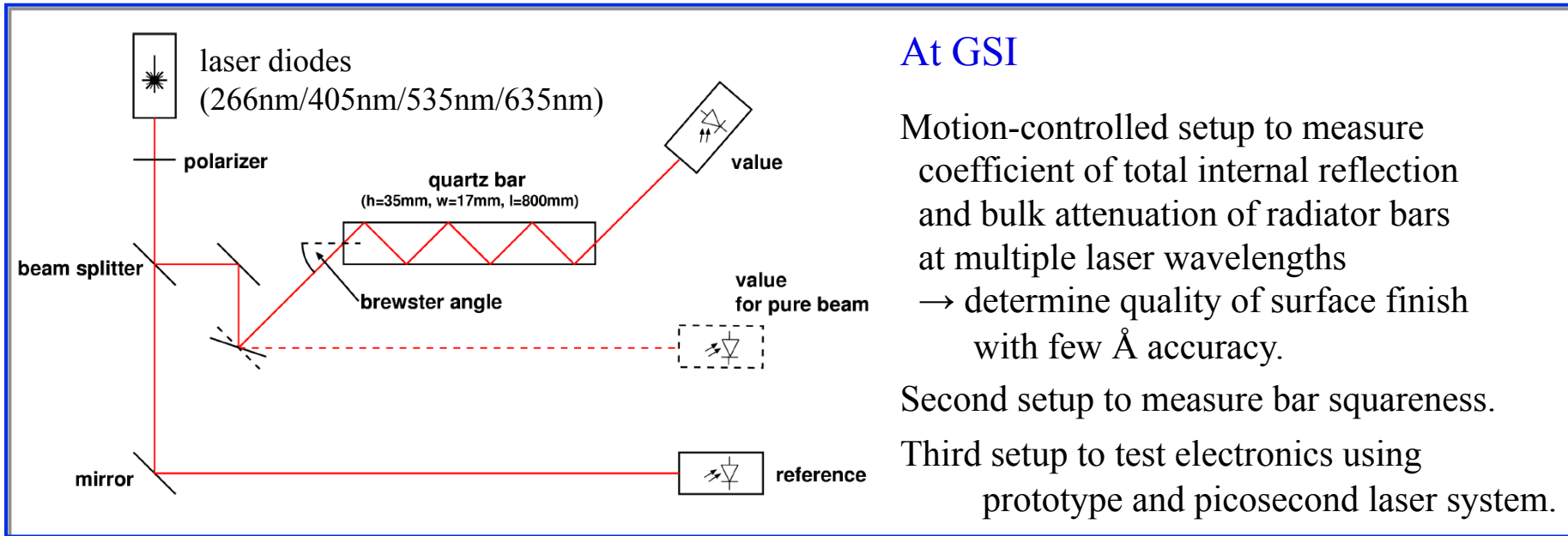

## Motion-controlled scanning setup

Scan bar surface for measurement of  
**coefficient of total internal reflection (R)**  
 and **bulk attenuation ( $\Lambda$ )** of prototype  
 radiator bars at **multiple laser wavelengths**

→ determine quality of surface finish with few Å accuracy.

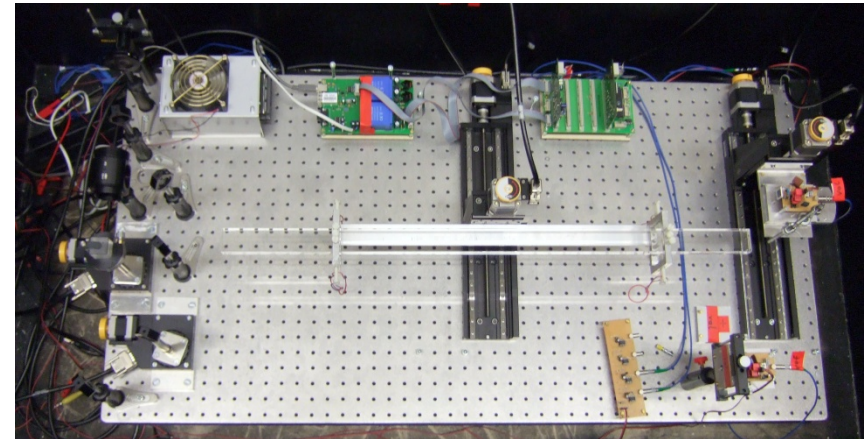

Testing **prototype bars** from

Heraeus, Schott Lithotec, Lytkarino LZOS, InSync Inc., discussing  
 prototype production with Zygo and Zeiss.

Raw material used: Suprasil 1 & 2, Lithosil Q0, Spectrosil.

Requirements on bulk attenuation, surface roughness, squareness of bar sides, flatness,  
 and edge quality expected to be comparable to BABAR-DIRC.

*(Shorter photon paths in PANDA will allow relaxation of some specs.)*

Scan ~100 bar entry positions with laser

- Determine **attenuation length**  $\Lambda$  by aiming laser down length of bar (*correct for Fresnel loss*).
- Measure **coefficient of total internal reflection**  $R$  by bouncing laser off bar surfaces; for 80 cm-long bar: 31 internal reflections from bar faces or 15 from bar sides.

- Diode measures **transmitted intensity**  $T$  (*normalized to reference intensity*).
- Calculate  $R$  from mean transmitted intensity  $T$ :

$$T = R^N \cdot \exp\left(-\frac{L}{\Lambda}\right)$$

- Calculate **surface roughness**  $\sigma$  from  $R$  using **scalar theory** of scattering:

$$R = 1 - \left(\frac{4\pi \cdot \sigma \cdot n \cdot \cos \alpha}{\lambda}\right)^2 \text{ for } \sigma \ll \lambda.$$

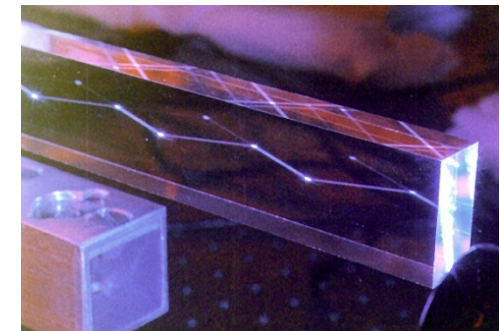
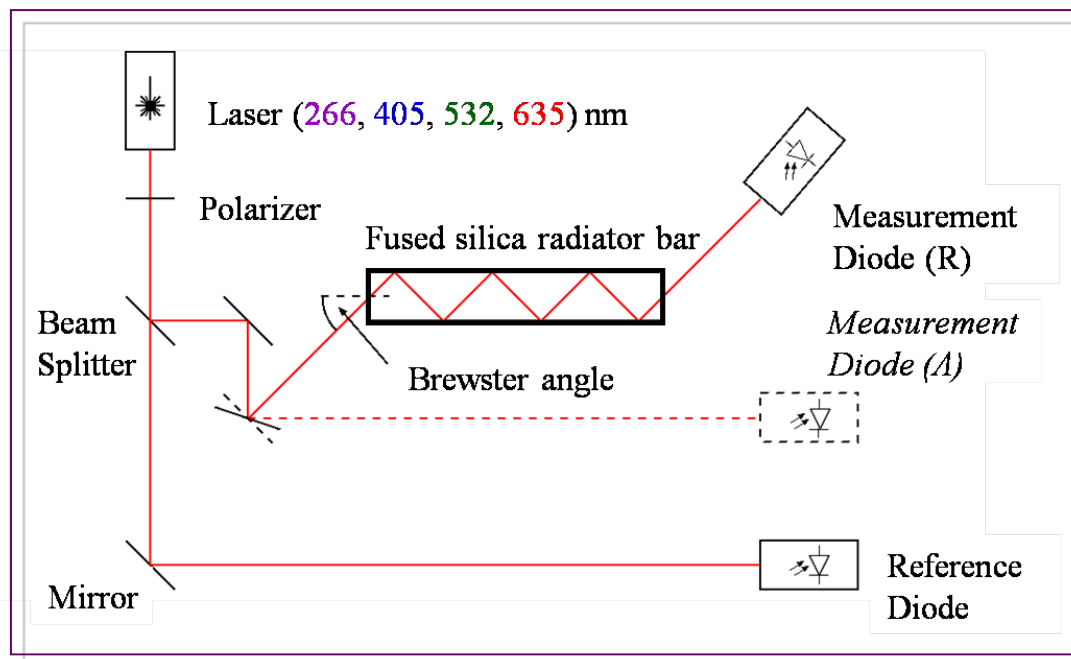

Measured coefficient of total internal reflection  
for a Schott Lithotec bar for three wavelengths  
compared to expectation from scalar theory of scattering.

R. Hohler  
DPG 2010

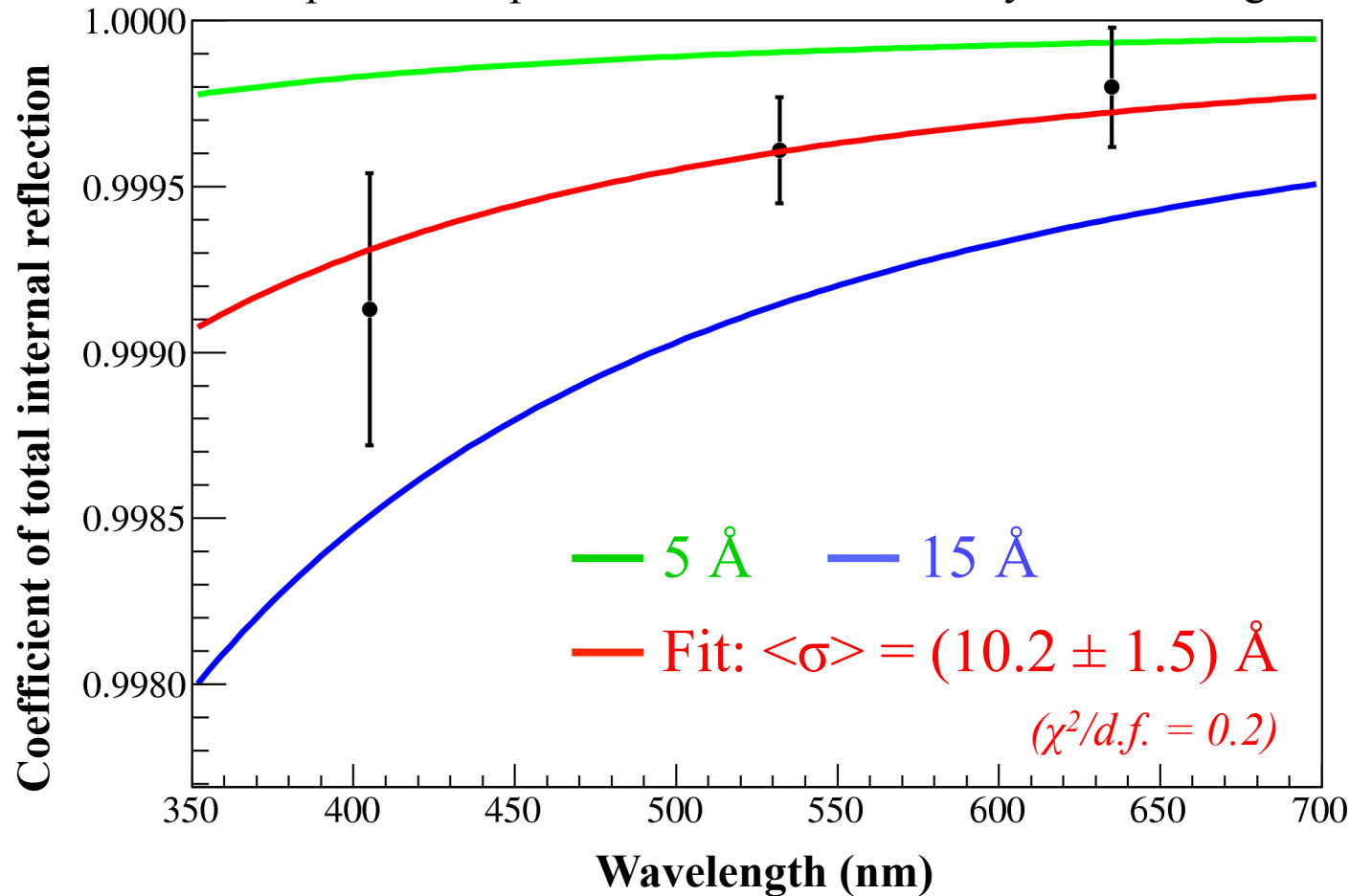

Good agreement with production specs from vendor: 10 – 20Å *rms* roughness.