

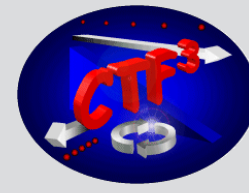

UPPSALA
UNIVERSITET



Two-beam Test Stand Status

Roger Ruber for the TBTS Team

<http://cern.ch/ctf3-tbts>

CTF3 Committee
19 Aug 2010

Effect of RF power on probe beam

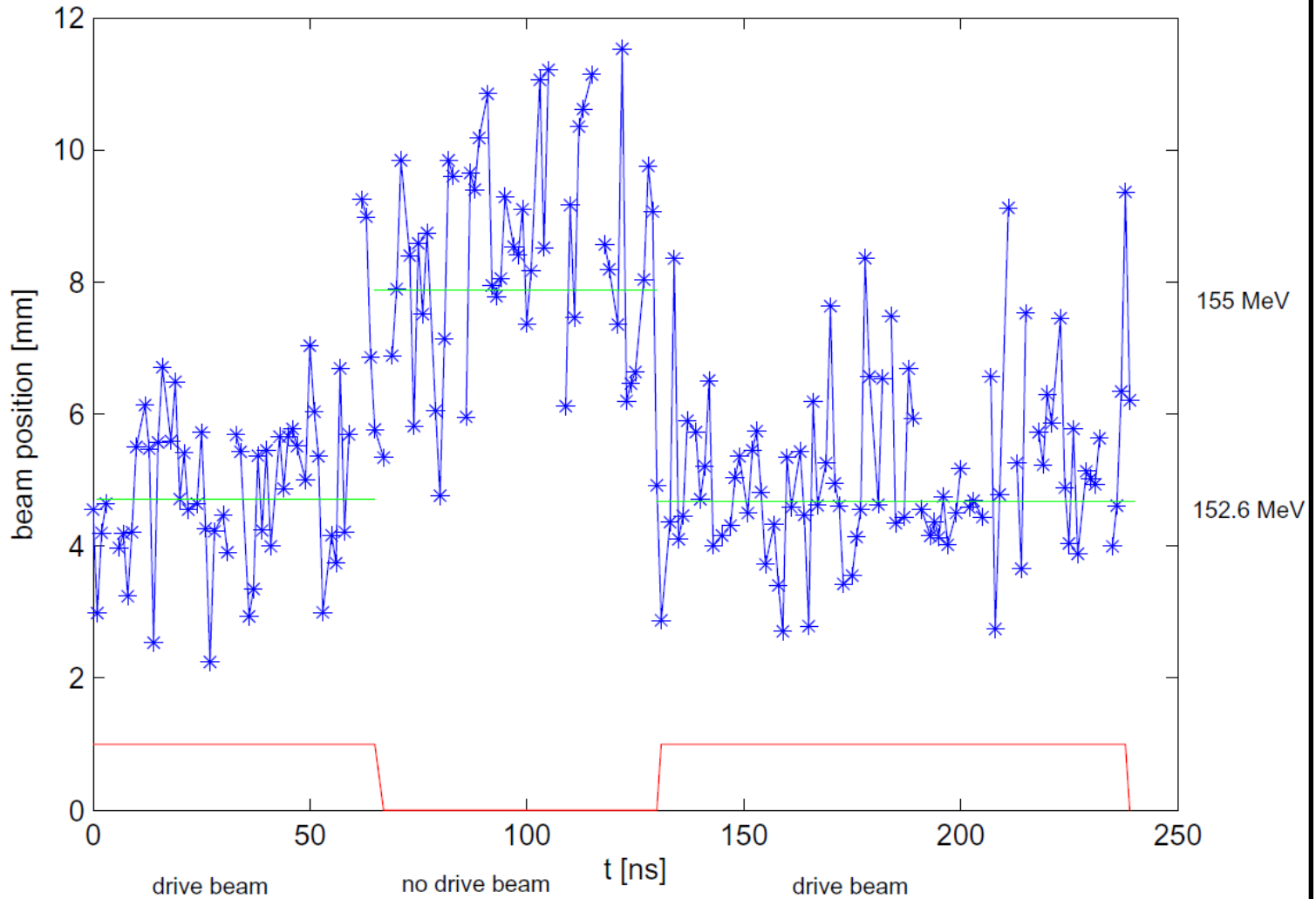
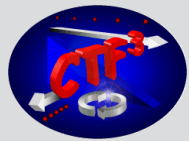

Breakdown in PETS Recirc. & ACS

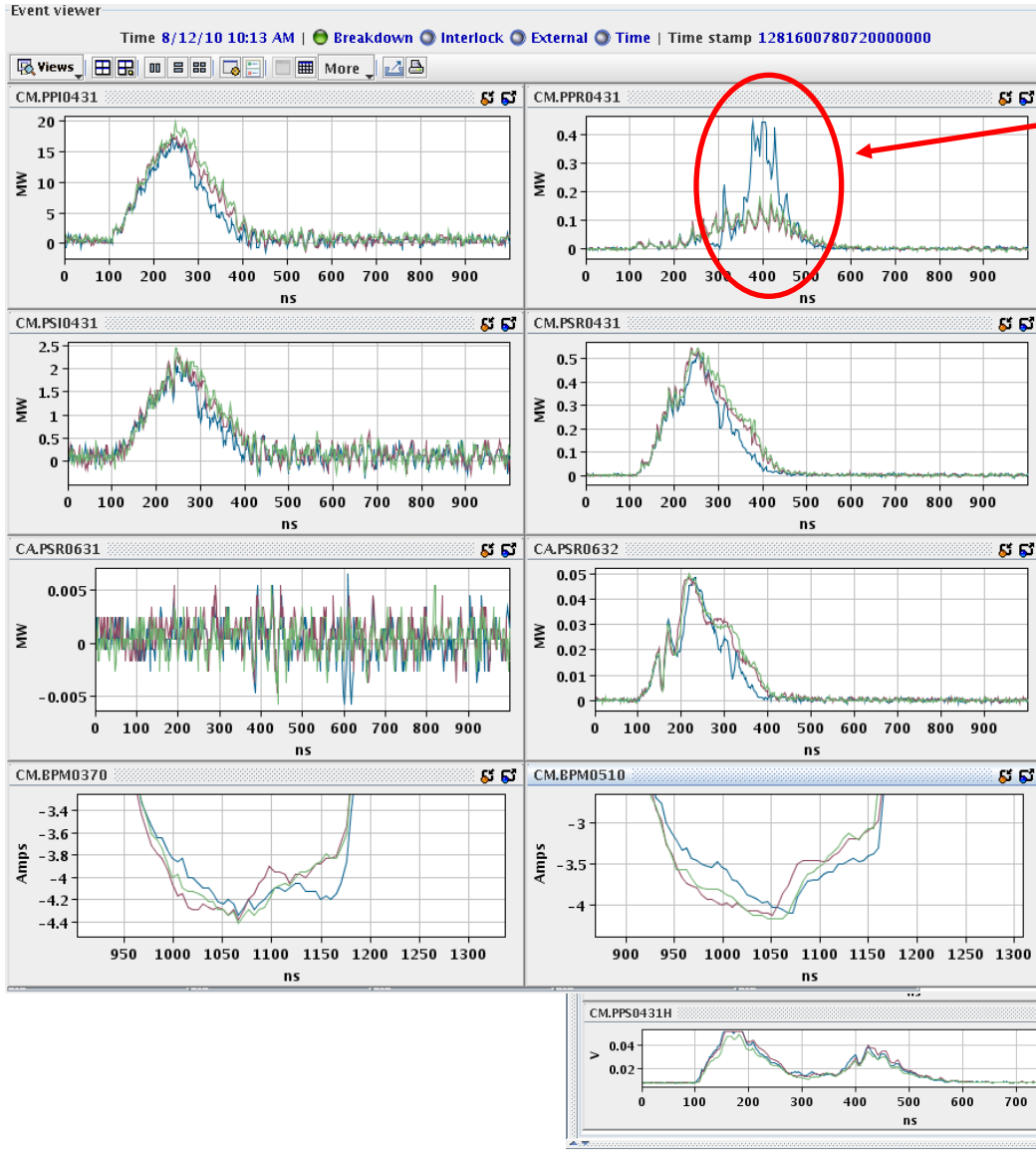
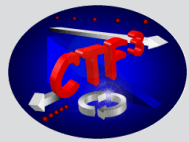

reflected power

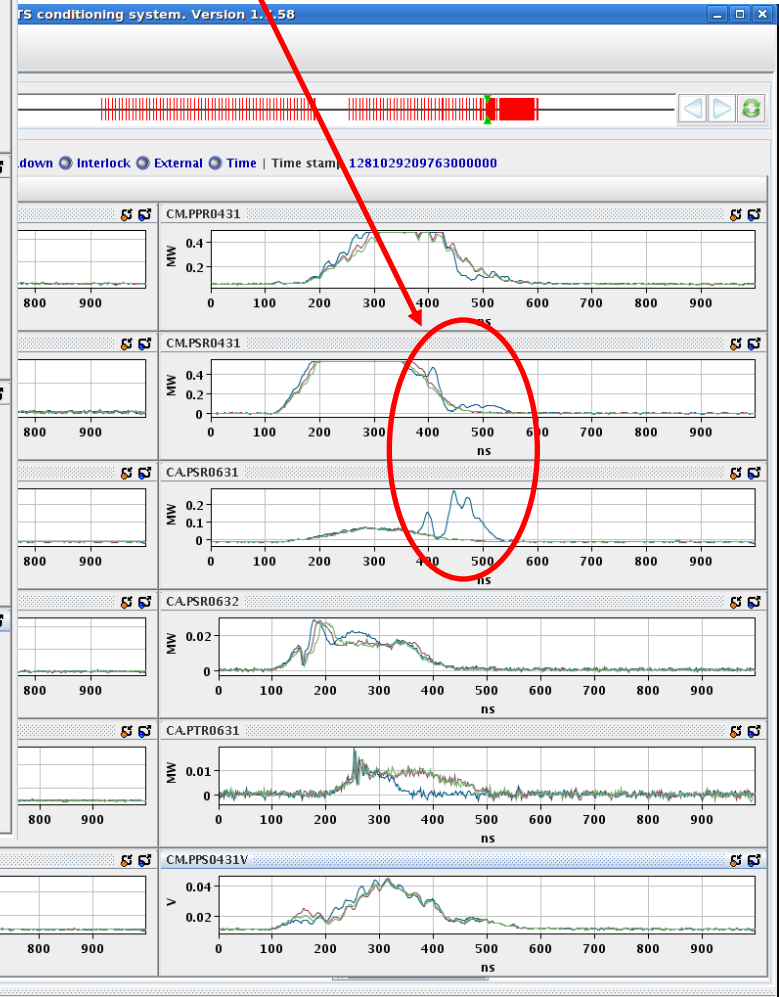

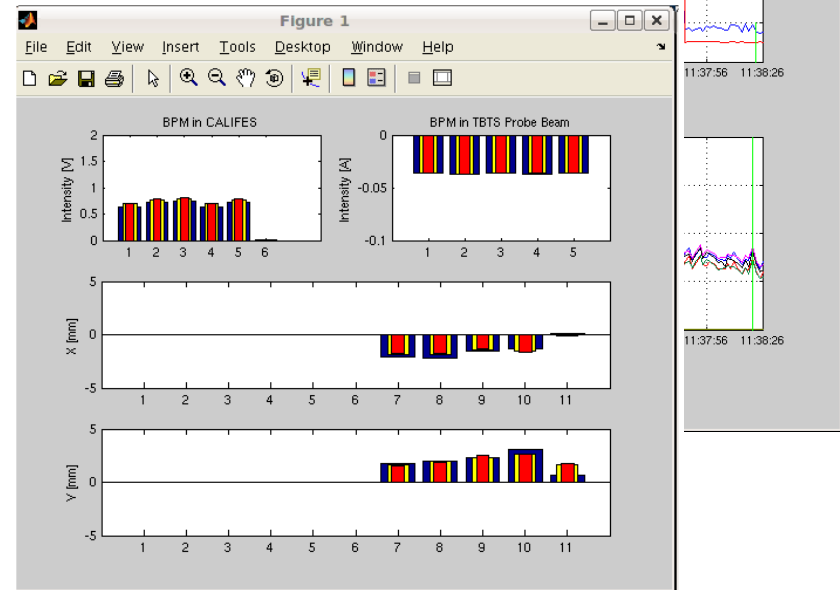
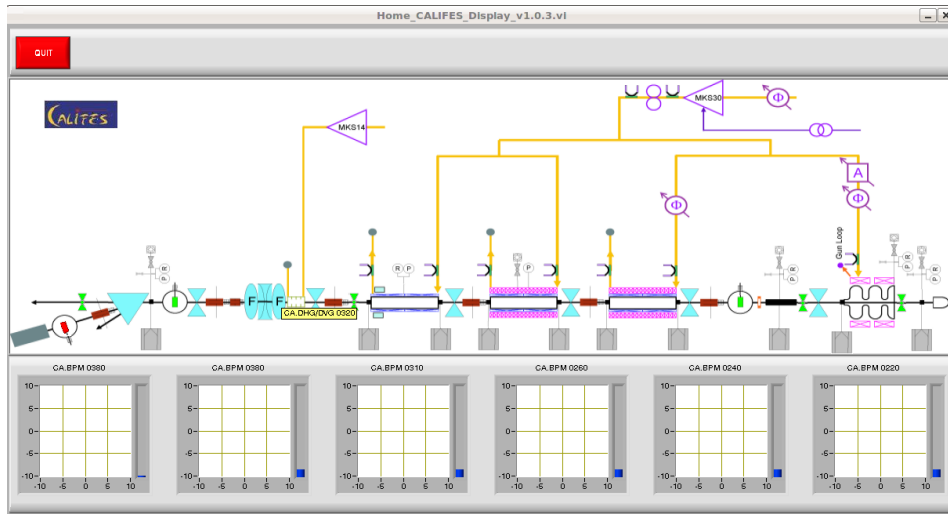
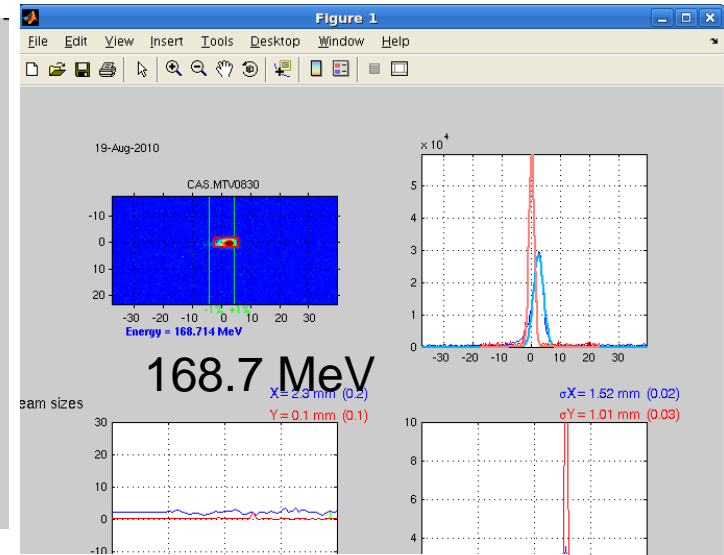
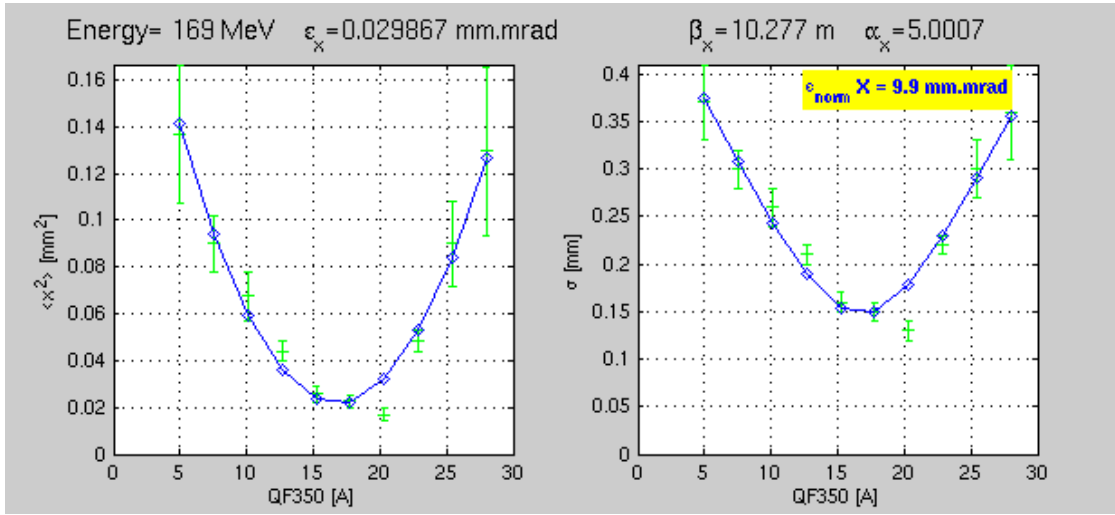
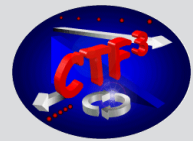

Flashbox for Electron and Ion Detection

