



Enabling Grids for E-science

Introduction to R-GMA: Relational Grid Monitoring Architecture

www.eu-egee.org



Slides are taken/derived from

- **the GILDA team**
- **Steve Fisher (RAL, UK) and the R-GMA team**

- **Uniform method to access and publish both information and monitoring data.**
- **From a user's perspective, an R-GMA installation currently appears similar to a single relational database.**
- **GMA (Grid Monitoring Architecture) was developed by the GGF**
- **R-GMA (Relational GMA) was created:**
 - To simplify use of GMA (servers “know” about registries, not the client software)
 - To give a relational view

- **Relational Grid Monitoring Architecture (R-GMA)**
 - Developed as part of the EuropeanDataGrid Project (EDG)
 - Now as part of the EGEE project.
 - Evolution from the Grid Monitoring Architecture (GMA)

- **Uses a relational data model.**
 - Data are viewed as a table.
 - Data structure defined by the columns.
 - Each entry is a row (tuple).
 - Queried using Structured Query Language (SQL).

name	ID	birth	Group
Tom	4	1977-08-20	HR

`SELECT * FROM people WHERE group='HR'`

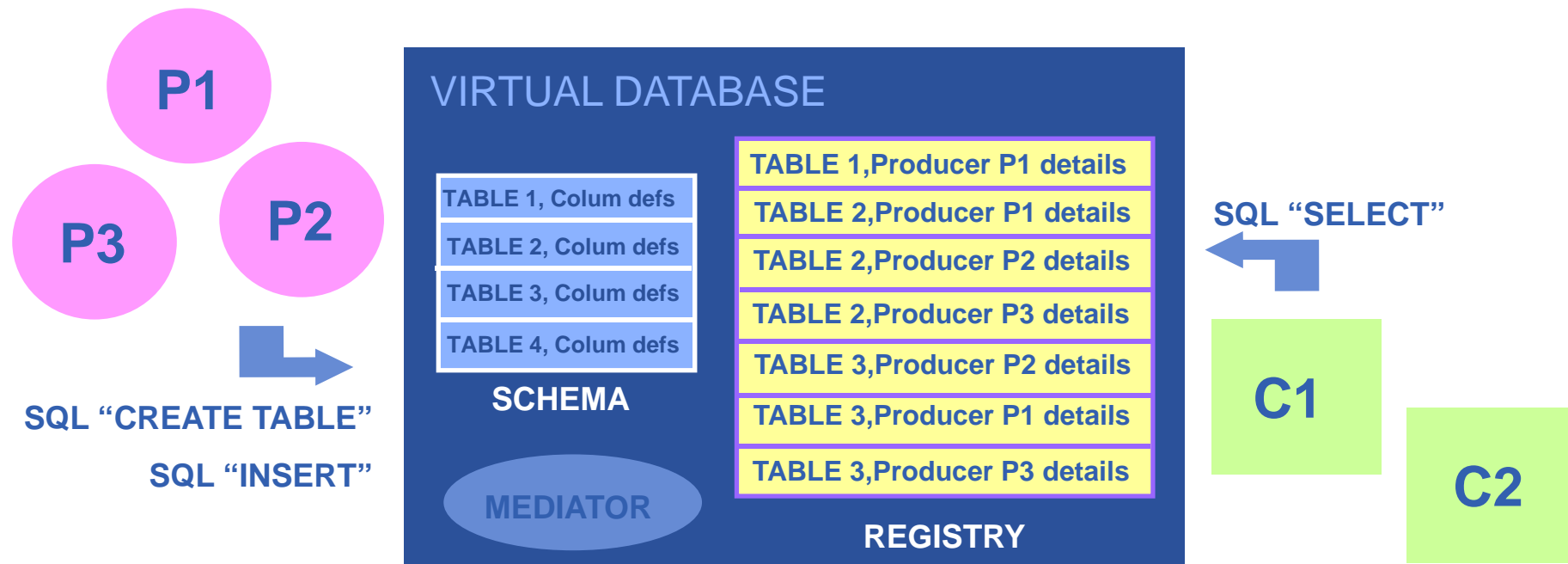

There is no central repository!!! There is only a “*Virtual Database*”.

Schema is a list of table definitions: additional tables/schema can be defined by applications

Registry is a list of data producers with all its details.

Producers publish data.

Consumers read data published.

- The Producer stores its location (URL) in the Registry.
- The Consumer looks up producer URLs in the Registry.
- The Consumer contacts the Producer to get all the data or the Consumer can listen to the Producer for new data.

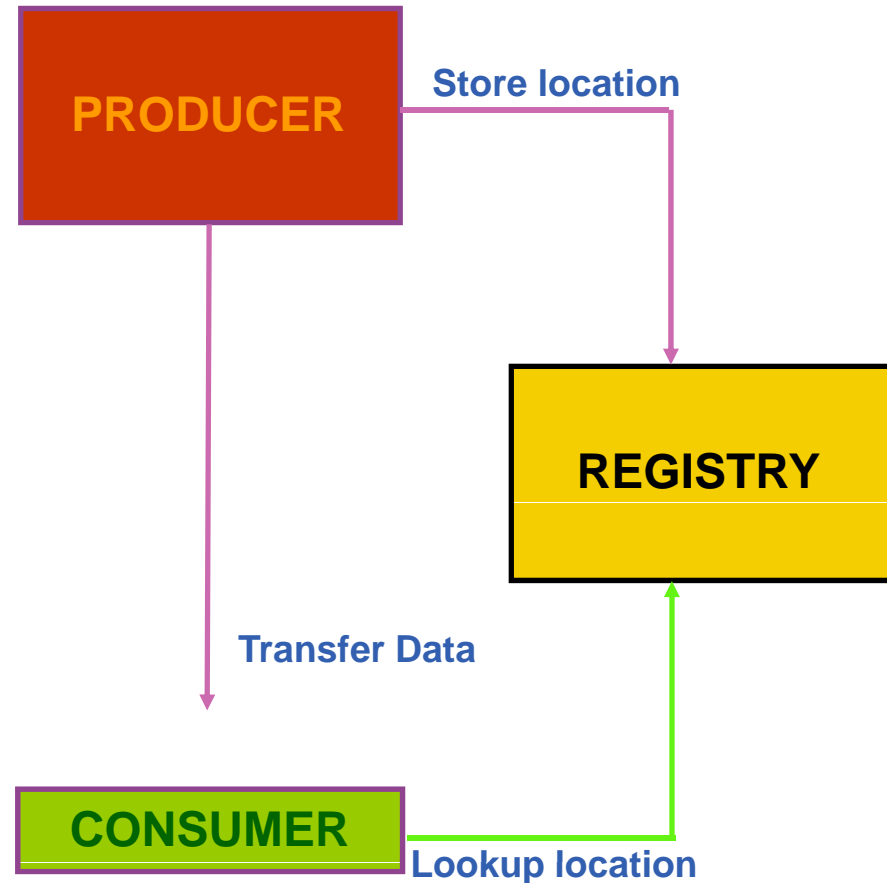

- The Consumer interrogates the Registry to identify all Producers that could satisfy the query.
- Consumer connects to the Producers.
- Producers send the tuples to the Consumer.
- The Consumer will merge these tuples to form one result set.

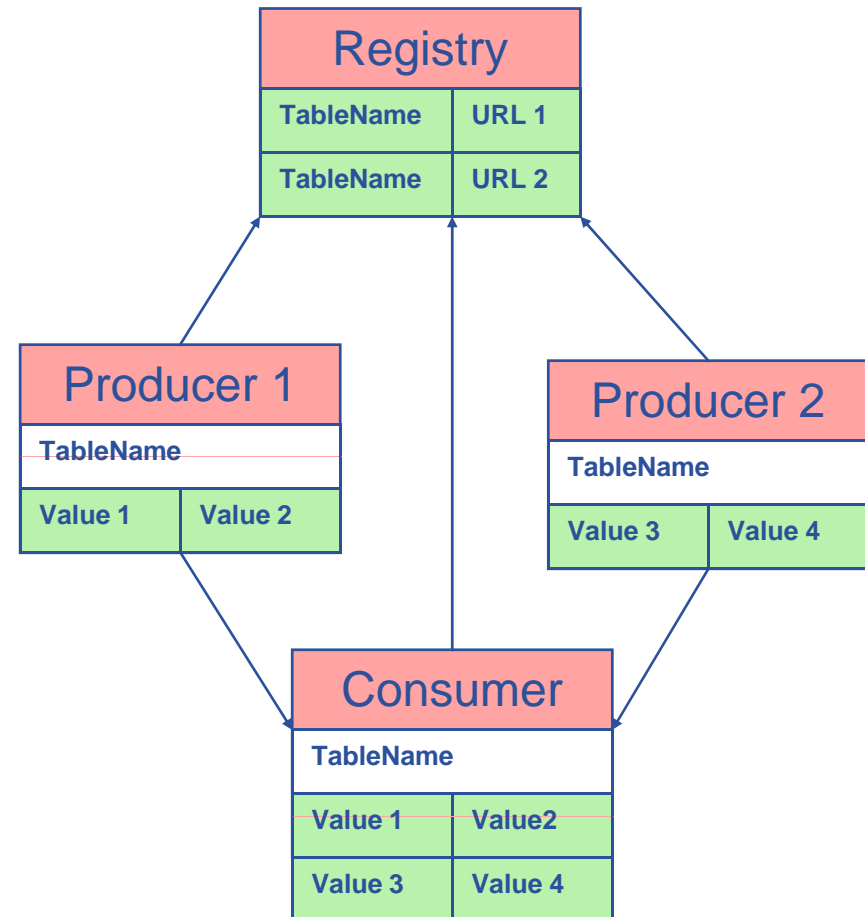

Service				
URI	VO	type	emailContact	site
gppse01	alice	SE	sysad@rl.ac.uk	RAL
gppse01	atlas	SE	sysad@rl.ac.uk	RAL
gppse02	cms	SE	sysad@rl.ac.uk	RAL
lxshare0404	alice	SE	sysad@cern.ch	CERN
lxshare0404	atlas	SE	sysad@cern.ch	CERN

ServiceStatus				
URI	VO	type	up	status
gppse01	alice	SE	y	SE is running
gppse01	atlas	SE	y	SE is running
gppse02	cms	SE	n	SE ERROR 101
lxshare0404	alice	SE	y	SE is running
lxshare0404	atlas	SE	y	SE is running

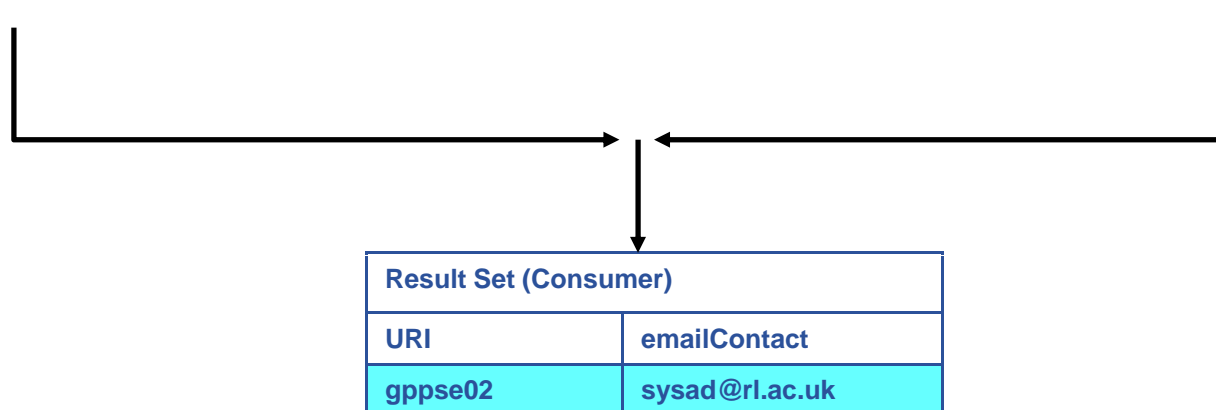

SELECT Service.URI Service.emailContact FROM Service S, ServiceStatus SS
WHERE (S.URI= SS.URI and SS.up='n')

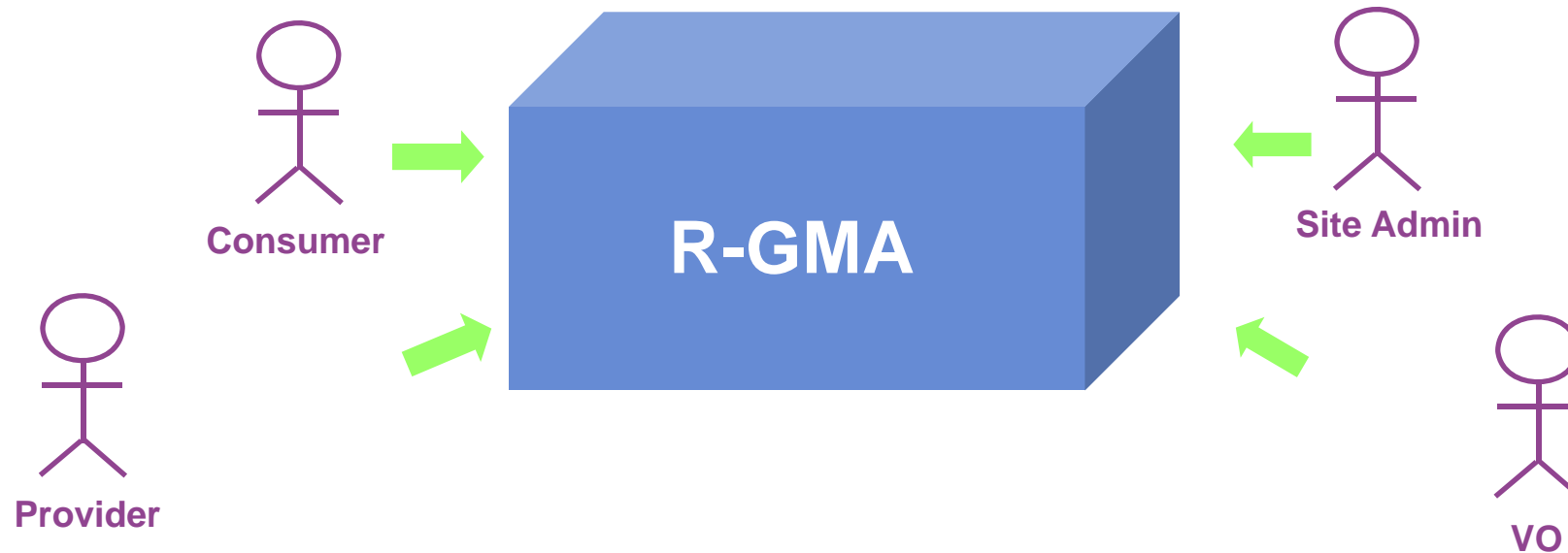

- **Consumer users:** who request information.
- **Producer users:** who provide information.
- **Site administrators:** who run R-GMA services.
- **Virtual Organizations:** who “own” the schema and registry.

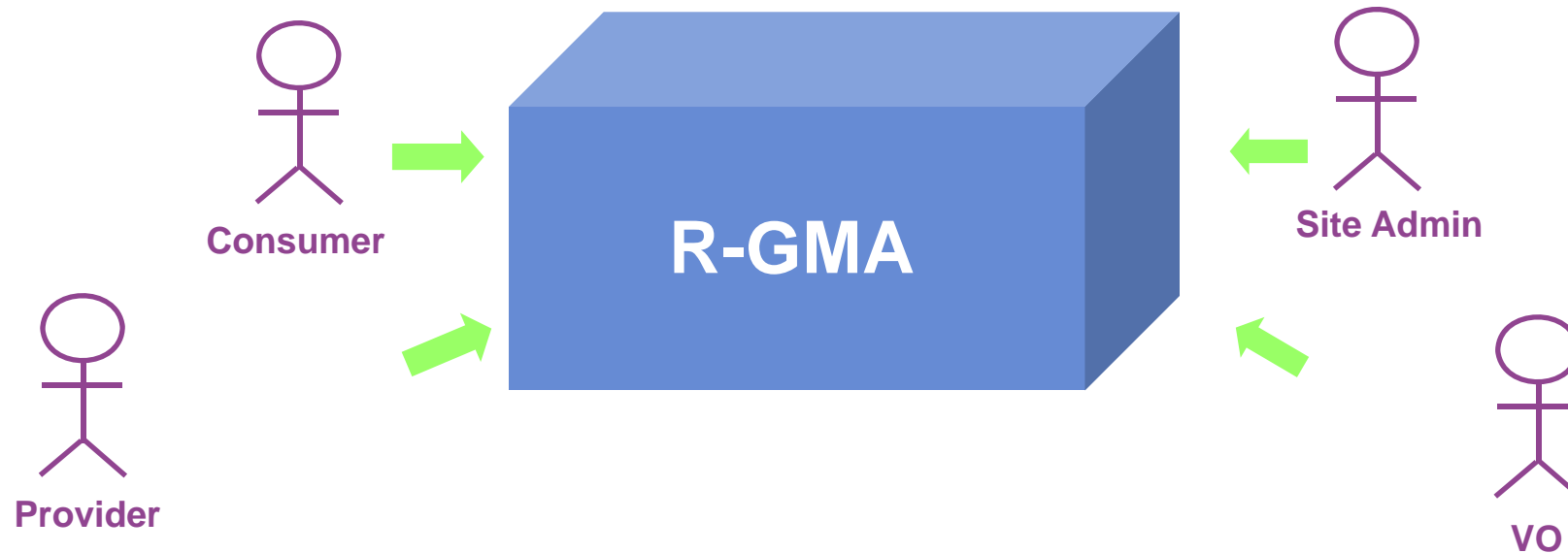

- **Mutual Authentication:** guaranteeing who is at each end of an exchange of messages.
- **Encryption:** using an encrypted transport protocol (HTTPS).
- **Authorization:** implicit or explicit.

- **Producer and Consumer Services are typically on a one per site basis**
- **Centralized Registry and Schema.**
- **The Registry and Schema may be replicated, to avoid a single point of failure**
 - ... when you use RGMA CLI you will see which are being used

- **Primary Producer**

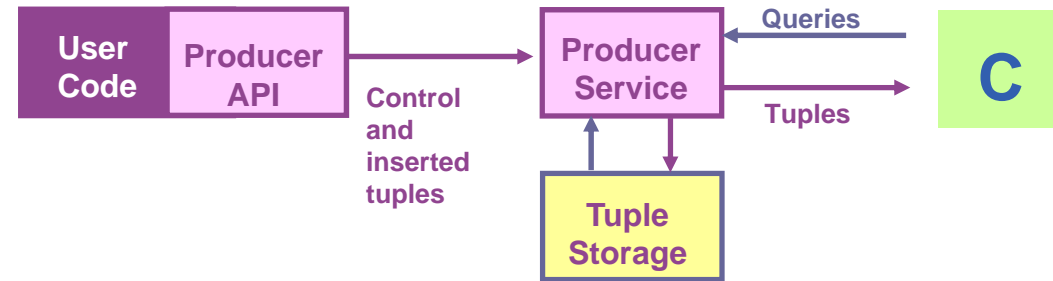

- **Secondary Producer**

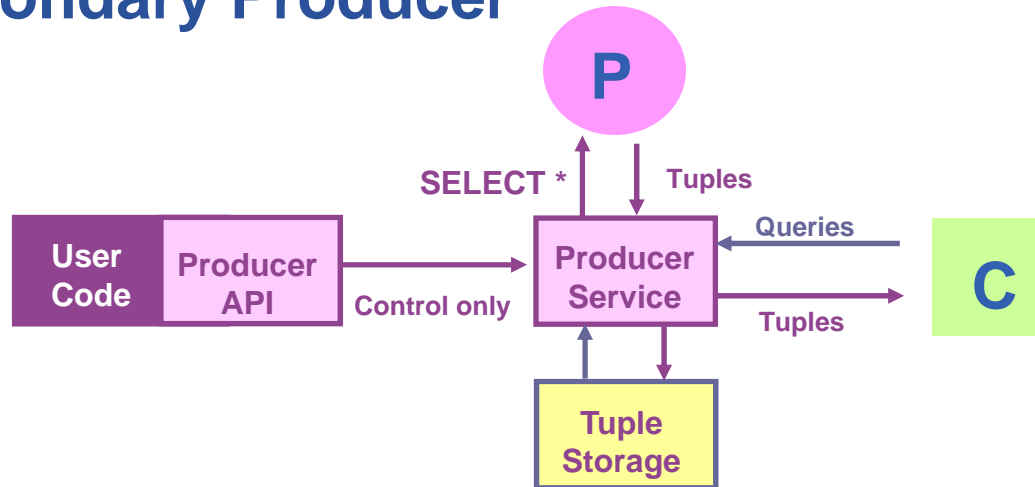

- **On-Demand Producer**

- No internal storage
- Queries passed to user code

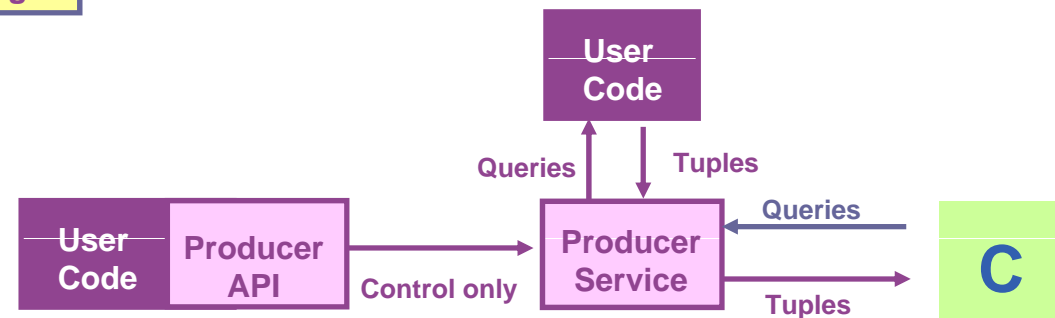

Continuous

- Latest
- History
- Static

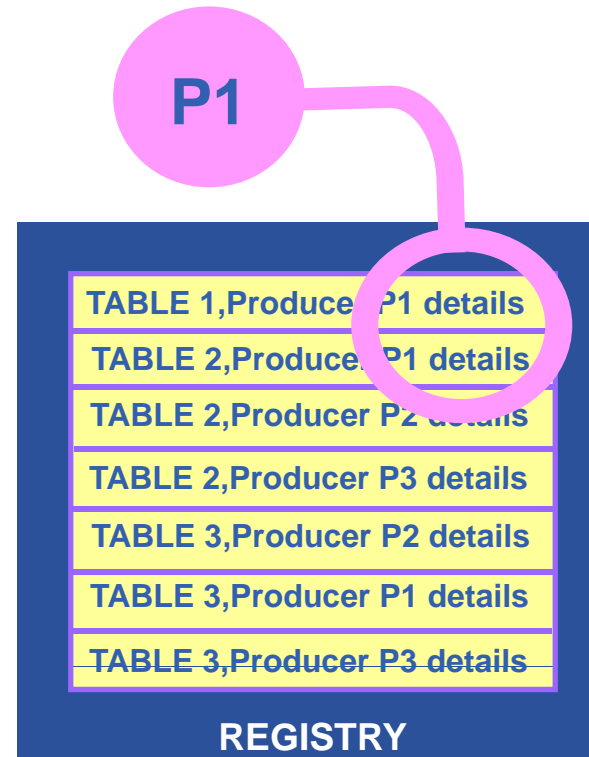

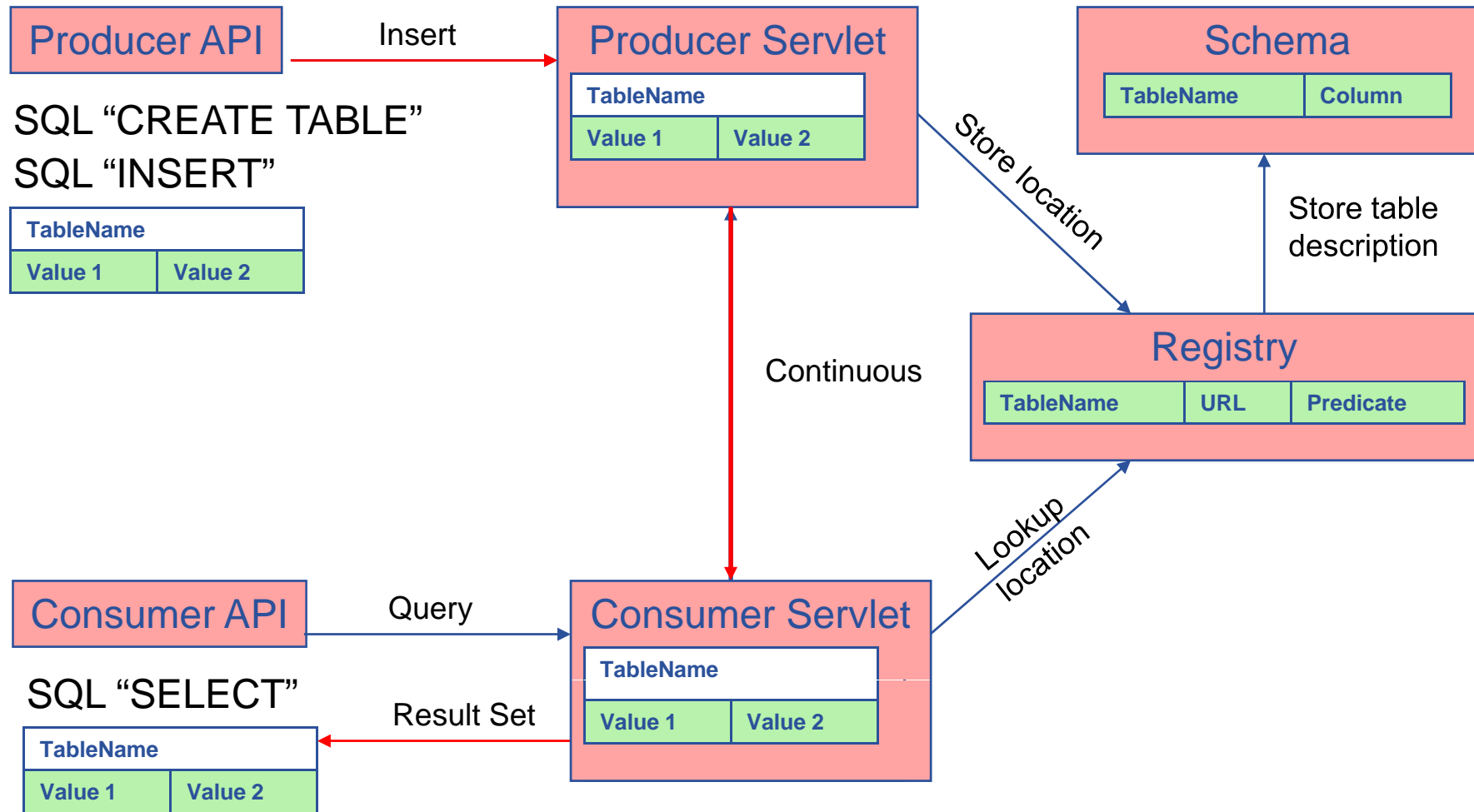

- Continuous
- Latest
- History
- Static

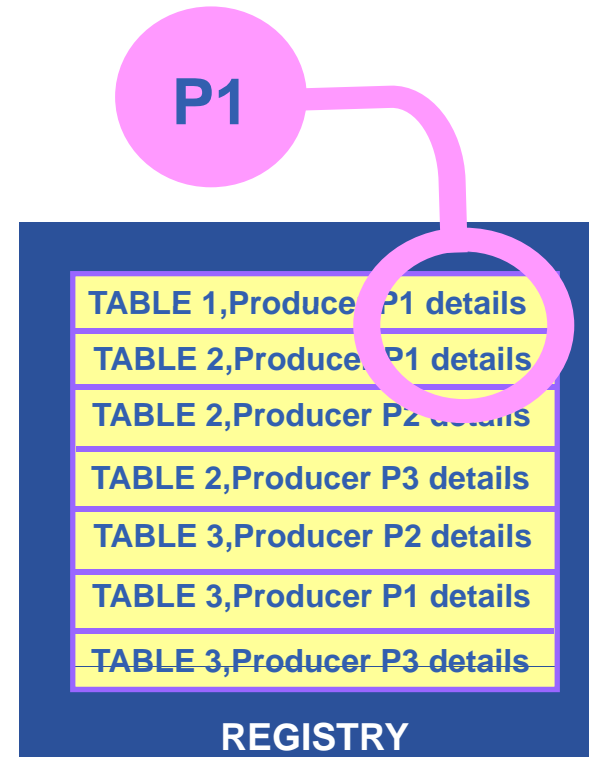

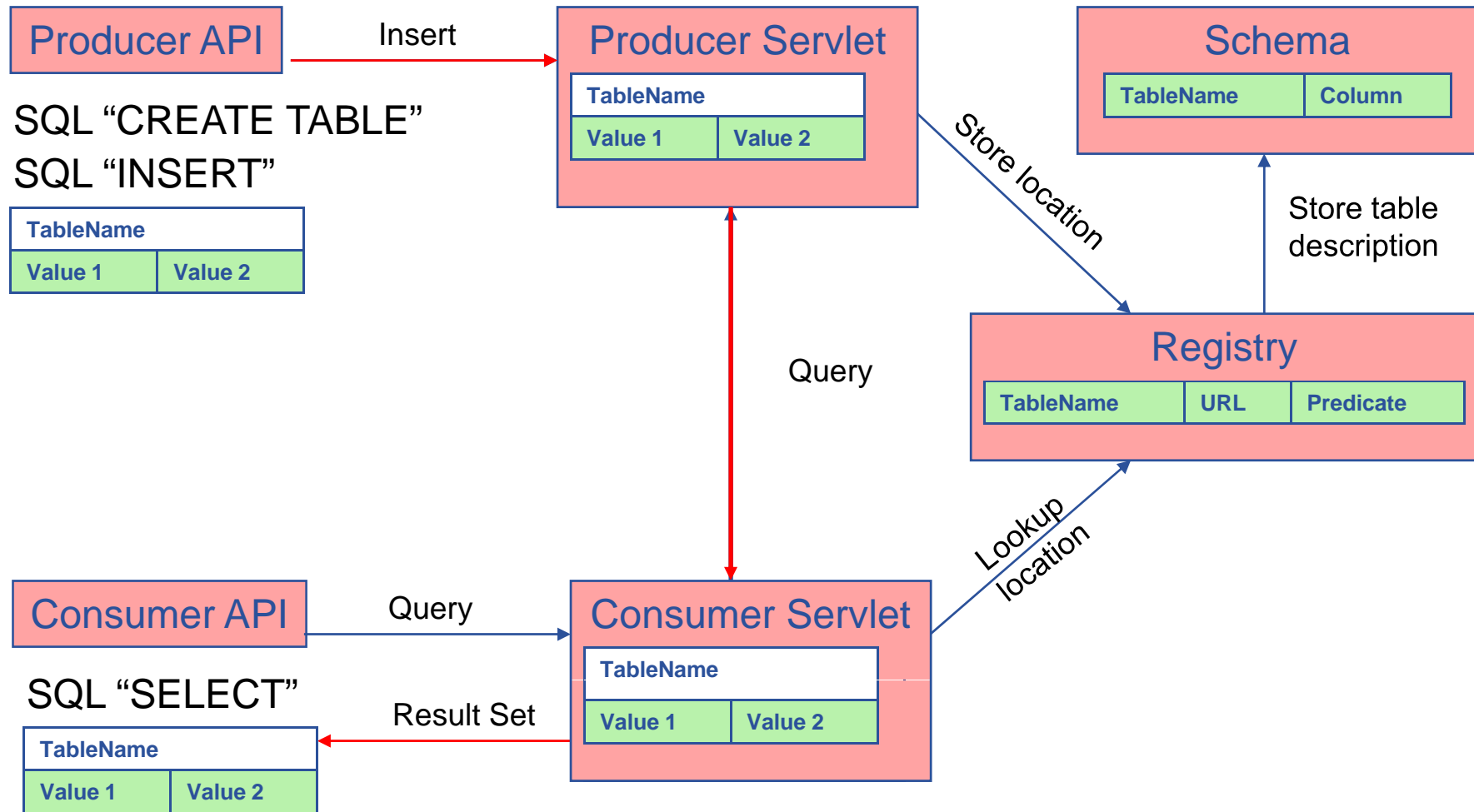

- Continuous
- Latest
- History
- Static

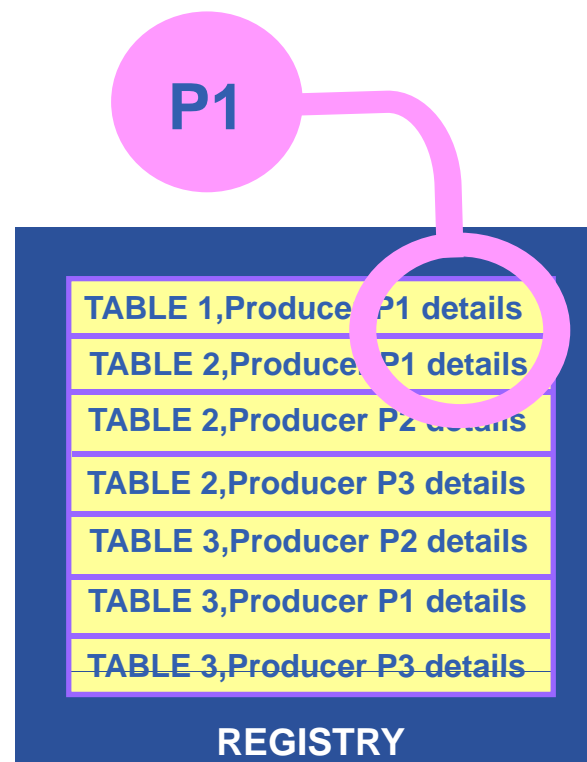
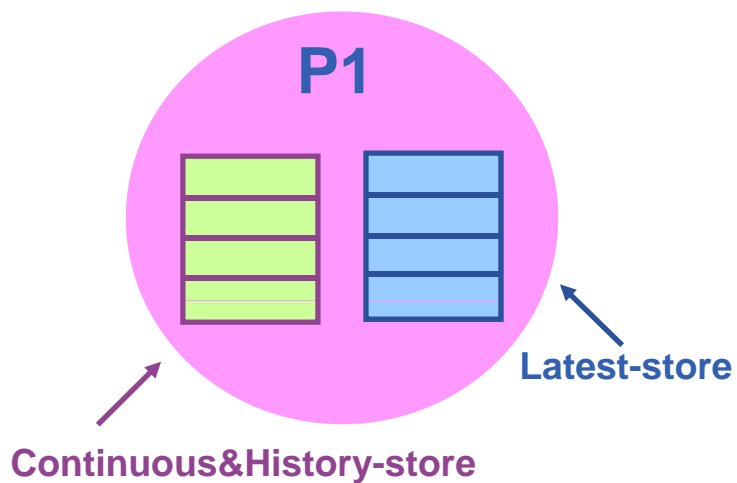

Latest Retention Period
History Retention Period

- SA1 have written script to “tail” FTP logs and publish via PP on gridFTP server nodes
- Continuous query pulls all the data to a central location and writes to an Oracle database for analysis
- Used for Service Challenge 3
- <http://gridview.cern.ch/GRIDVIEW/>

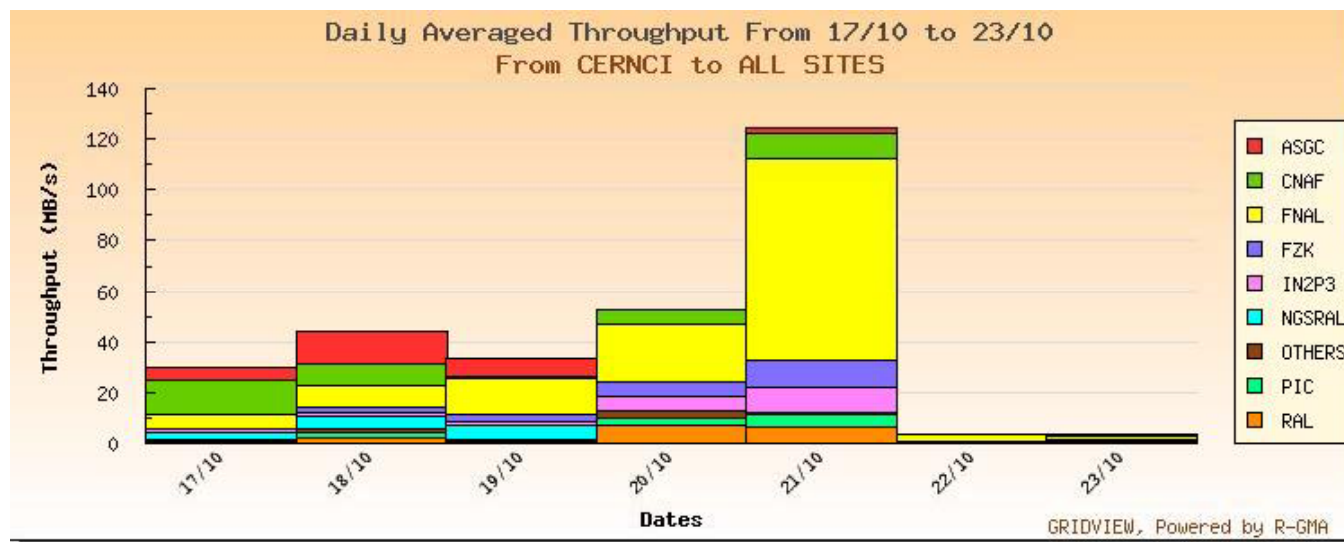
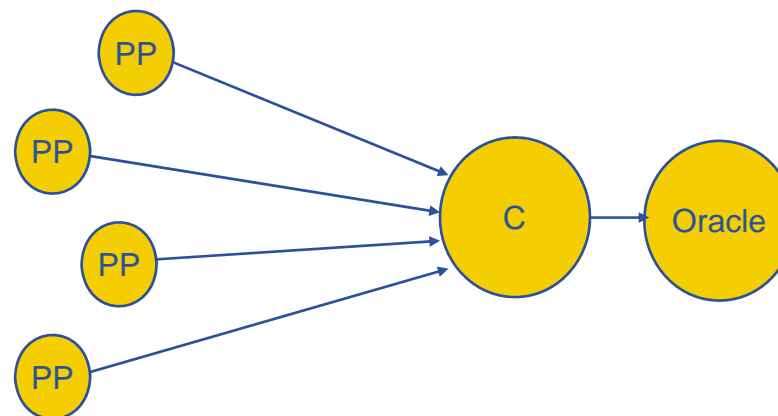

- Reads L&B logs on the resource broker nodes.
- Publishes data on state of jobs
- A database secondary producer is used to aggregate the data as well as a gridView consumer.
- CMS dashboard
 - <http://lxarda09.cern.ch/dashboard/request.py/jobsummary?>

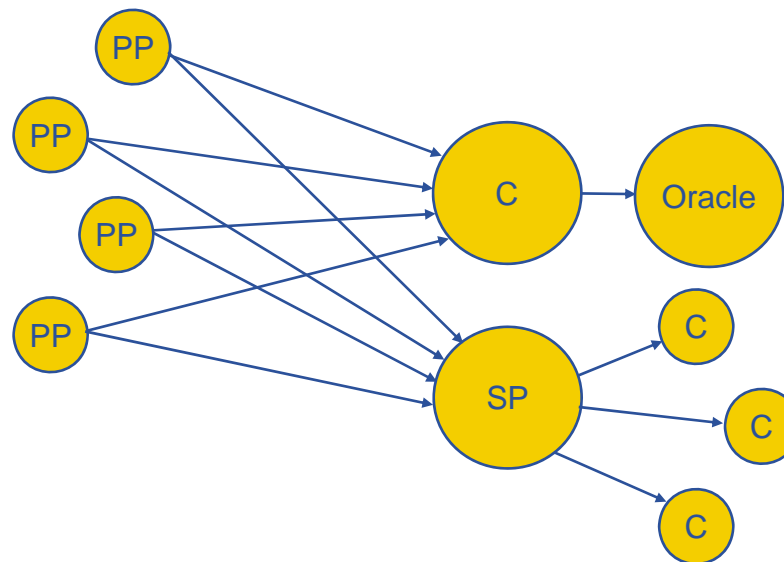

- On the WNs, the Job Wrapper (if enabled by JDL) periodically publishes information about the state of the process running the job and its environment.
- A database secondary producer is used to aggregate the data.
 - <https://rgma13.pp.rl.ac.uk:8443/R-GMABrowser/Browser.do/queryTable?selectQueryType=latest&duration=20&tableName=JobMonitor>

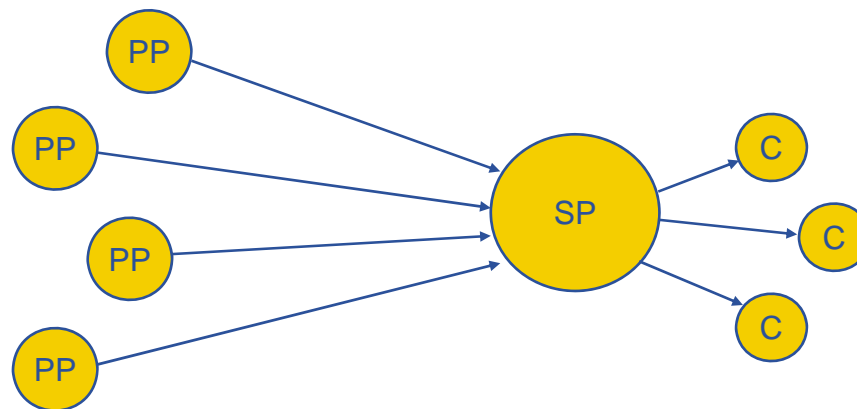

- **Network performance data important:**
 - to detect and resolve network problems.
 - to intelligently schedule jobs based on network load and reliability.
- **active measurements between end-sites, using tools such as**
 - iperf,
 - udpmon
 - ping.

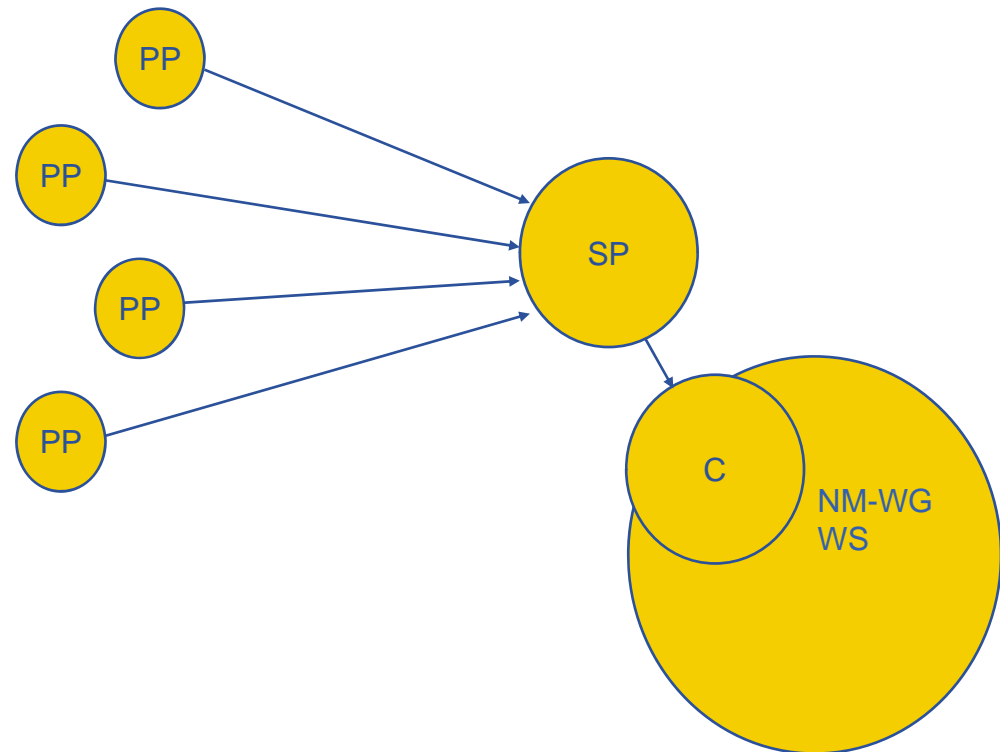

• <https://egee.epcc.ed.ac.uk:28443/npm-dt/query.jsp>

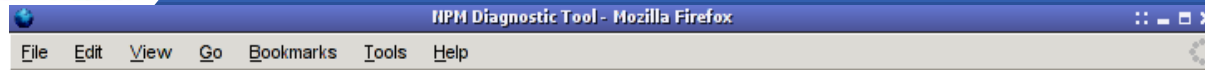

NPM Diagnostic Tool



Query

Time Range Set

Start: 2005-10-22 14:30:00 End: 2005-10-24 14:30:00 Focus: 2005-10-24 14:30:00
 End: 2005-10-24 14:30:00 Period: 2 Days Tolerance [s]: minus 172800 plus 0

Max Results

Maximum number of results

Test Path

Source:

Destination:

Path: e2emonit.nesc.ed.ac.uk => e2emonit.mrs.grid.cnrs.fr

Metric Set

Metric: byte byte

Packet Size: Packets: Packet Gap:

Statistic Set

Statistic: Interval: Minutes

View As

Data Table Matrix Time Plot Histogram

[Create a new query.](#)

You are logged in as: CN=alstair.phipps, L=NESC, OU=Edinburgh, O=e Science, C=UK
 NPM Diagnostic Tool (1.1) © Members of the EGEE Collaboration 2005
[Email the DT administrator](#) | [Download the DT User Guide](#)

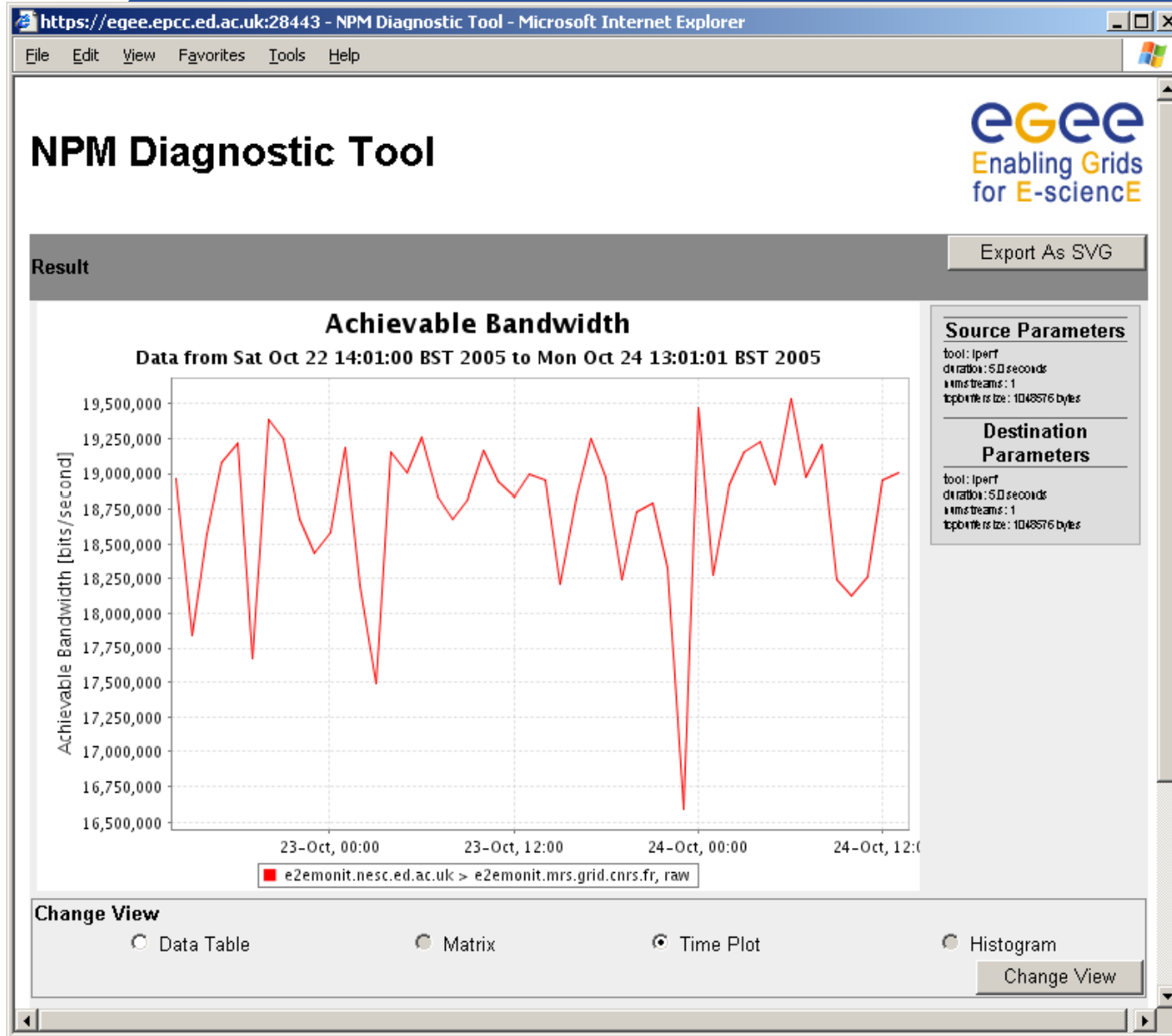

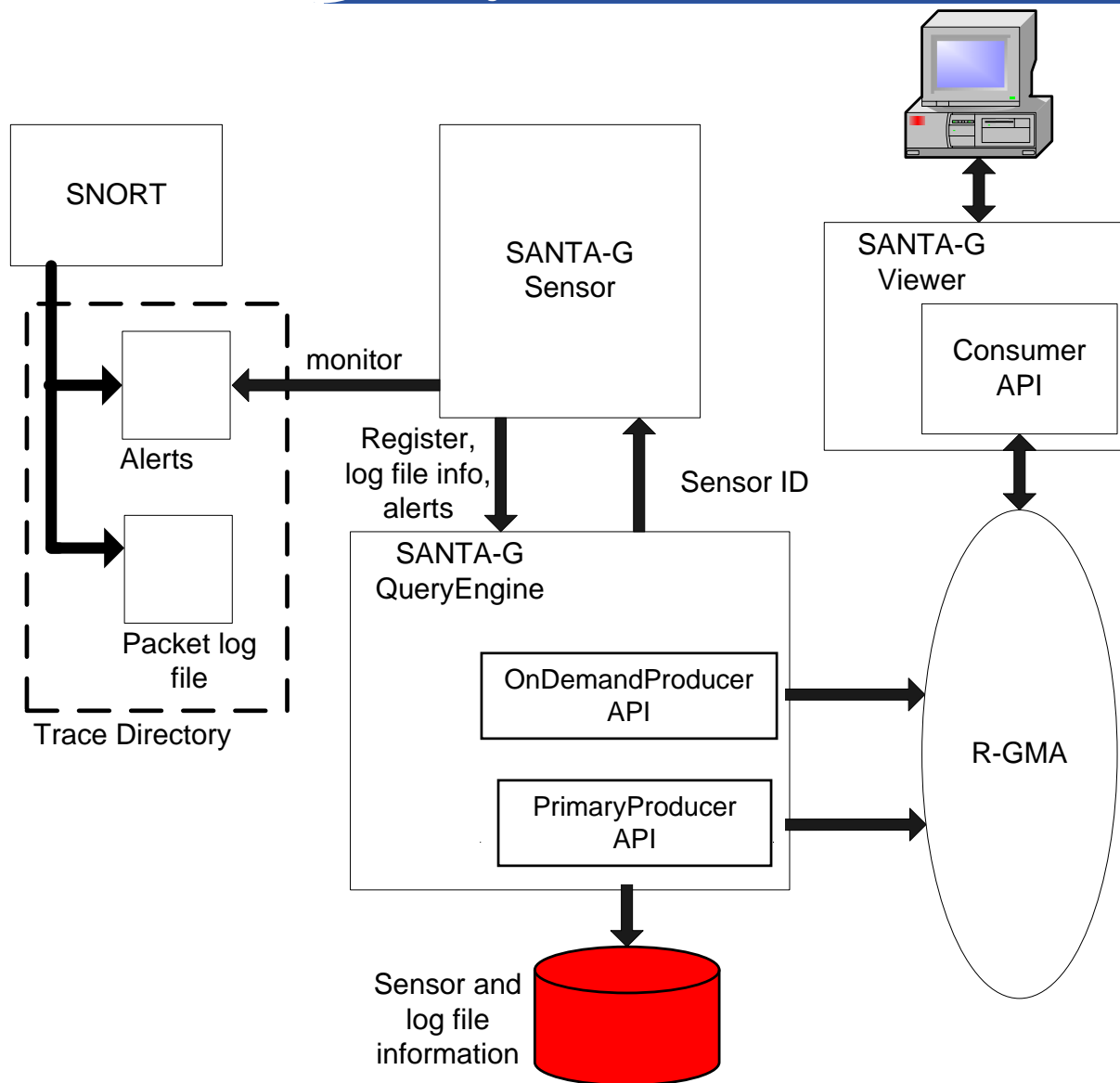

The Grid intrusion detection work is now within the Interactive European Grid (<http://www.interactive-grid.eu>) project, as part of the JRA workpackage, and is known as Active Security (<http://www.grid.ie/i2g>)

- **Questions to answer:**
 - “I am at CERN, in 'dteam' VO. Where is a MyProxy server?”
 - `glite-sd-query -t myproxy -s CERN-PROD`
- **Service Discovery offers:**
 - client API (library) to hide the differences
 - plug-in architecture to simplify dependencies
 - uses the subset of Glue schema as data model
 - simple API, no complex queries
 - CLI for other tools and testing
- **Plug-ins for:**
 - BDII
 - R-GMA
 - MDS4 (not yet)
 - File (only for testing)

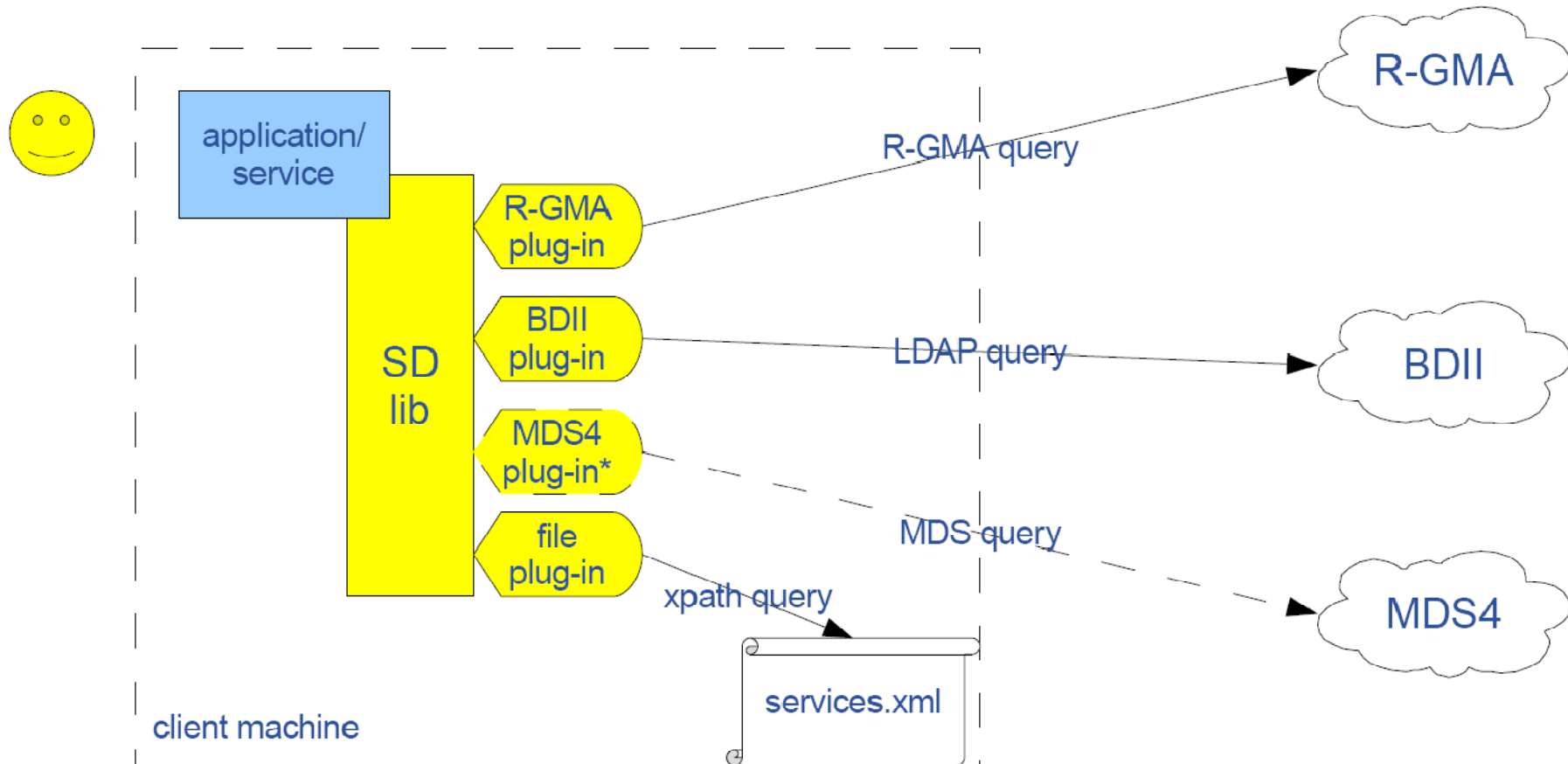

TCD: Trinity College Dublin

- **gridFS: a grid filesystem**
- **InfoGrid: a grid using an information model**
- **Keith Rochford's work on grid service monitoring**
- **Adaptive eLearning: R-GMA is the first course**
- **Shared memory for grids (SMG)**

- **APIs exist in Java, C, C++, Python.**
 - For clients (servlets contacted behind the scenes)
- **They include methods for...**
 - Creating consumers
 - Creating primary and secondary producers
 - Setting type of queries, type of produces, retention periods, time outs...
 - Retrieving tuples, inserting data
 - ...
- **You can create your own Producer or Consumer.**

- We will use a client that gives command-line interfaces to both consumers and producers
- We will explore the tables on the R-GMA service provided on GILDA
- Use a table that is set up for training purposes to produce and consume data

Now please follow the “more information” link

R-GMA practical html page

- The command line tool can be used in batch mode in three ways:
 - **rgma -c <command>**
Executes <command> and exits.
The **-c** option may be specified more than once.
 - **rgma -f <file>**
Executes commands in <file> sequentially then exits.
Each line should contain one command.
 - Embedded in a shell script

R-GMA Browser

requires certificate in browser

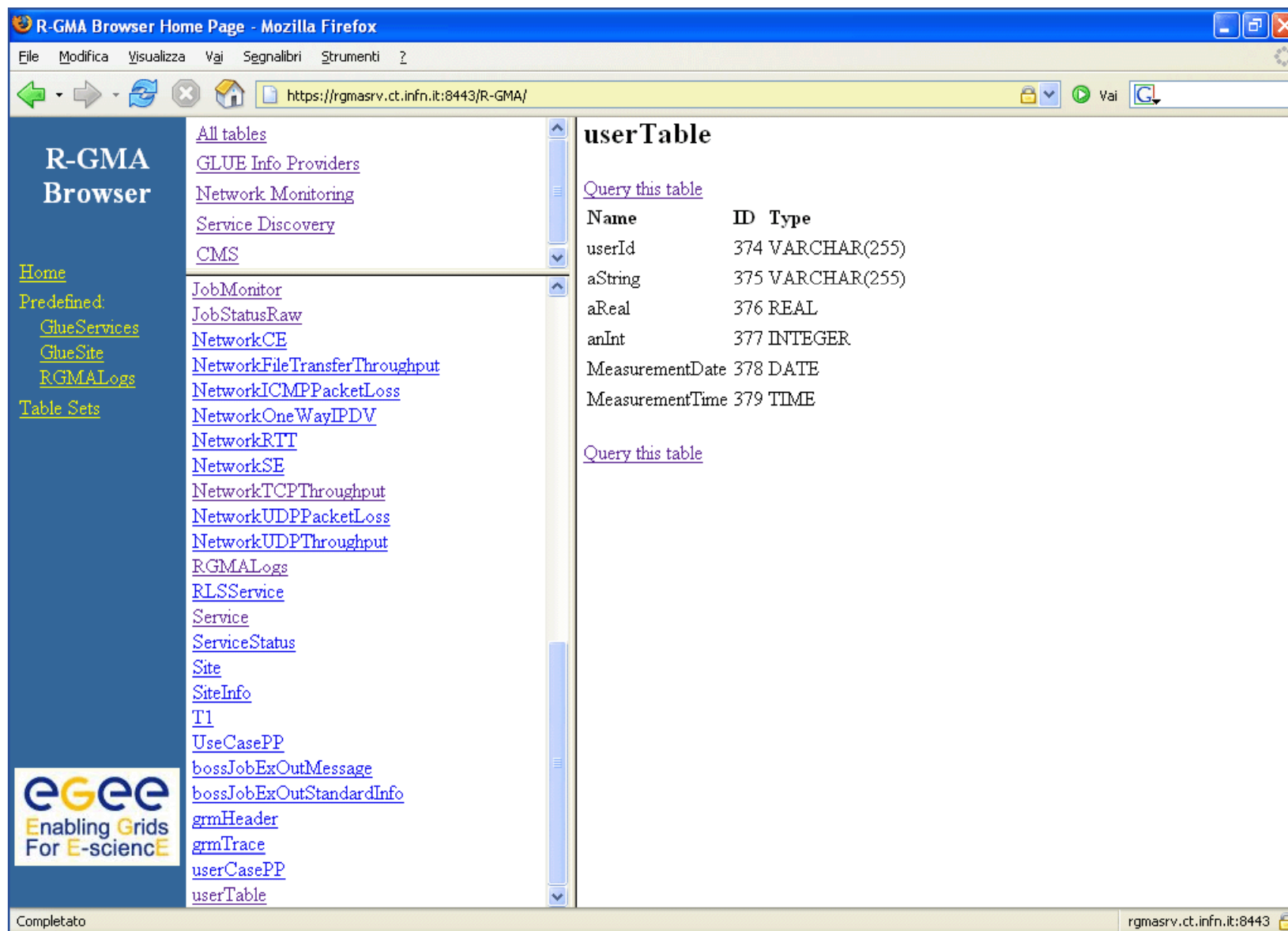

R-GMA Browser Home Page - Mozilla Firefox

File Modifica Visualizza Vai Segnalibri Strumenti ?

https://rgmasrv.ct.infn.it:8443/R-GMA/

R-GMA Browser

Home

Predefined:

- [GlueServices](#)
- [GlueSite](#)
- [RGMALogs](#)

Table Sets

- [All tables](#)
- [GLUE Info Providers](#)
- [Network Monitoring](#)
- [Service Discovery](#)
- [CMS](#)
- [JobMonitor](#)
- [JobStatusRaw](#)
- [NetworkCE](#)
- [NetworkFileTransferThroughput](#)
- [NetworkICMPPacketLoss](#)
- [NetworkOneWayIPDV](#)
- [NetworkRTT](#)
- [NetworkSE](#)
- [NetworkTCPThroughput](#)
- [NetworkUDPPacketLoss](#)
- [NetworkUDPThroughput](#)
- [RGMALogs](#)
- [RLSService](#)
- [Service](#)
- [ServiceStatus](#)
- [Site](#)
- [SiteInfo](#)
- [T1](#)
- [UseCasePP](#)
- [bossJobExOutMessage](#)
- [bossJobExOutStandardInfo](#)
- [gmHeader](#)
- [gmTrace](#)
- [userCasePP](#)
- [userTable](#)

userTable

[Query this table](#)

Name	ID	Type
userId	374	VARCHAR(255)
aString	375	VARCHAR(255)
aReal	376	REAL
anInt	377	INTEGER
MeasurementDate	378	DATE
MeasurementTime	379	TIME

[Query this table](#)

Completato rgmasrv.ct.infn.it:8443

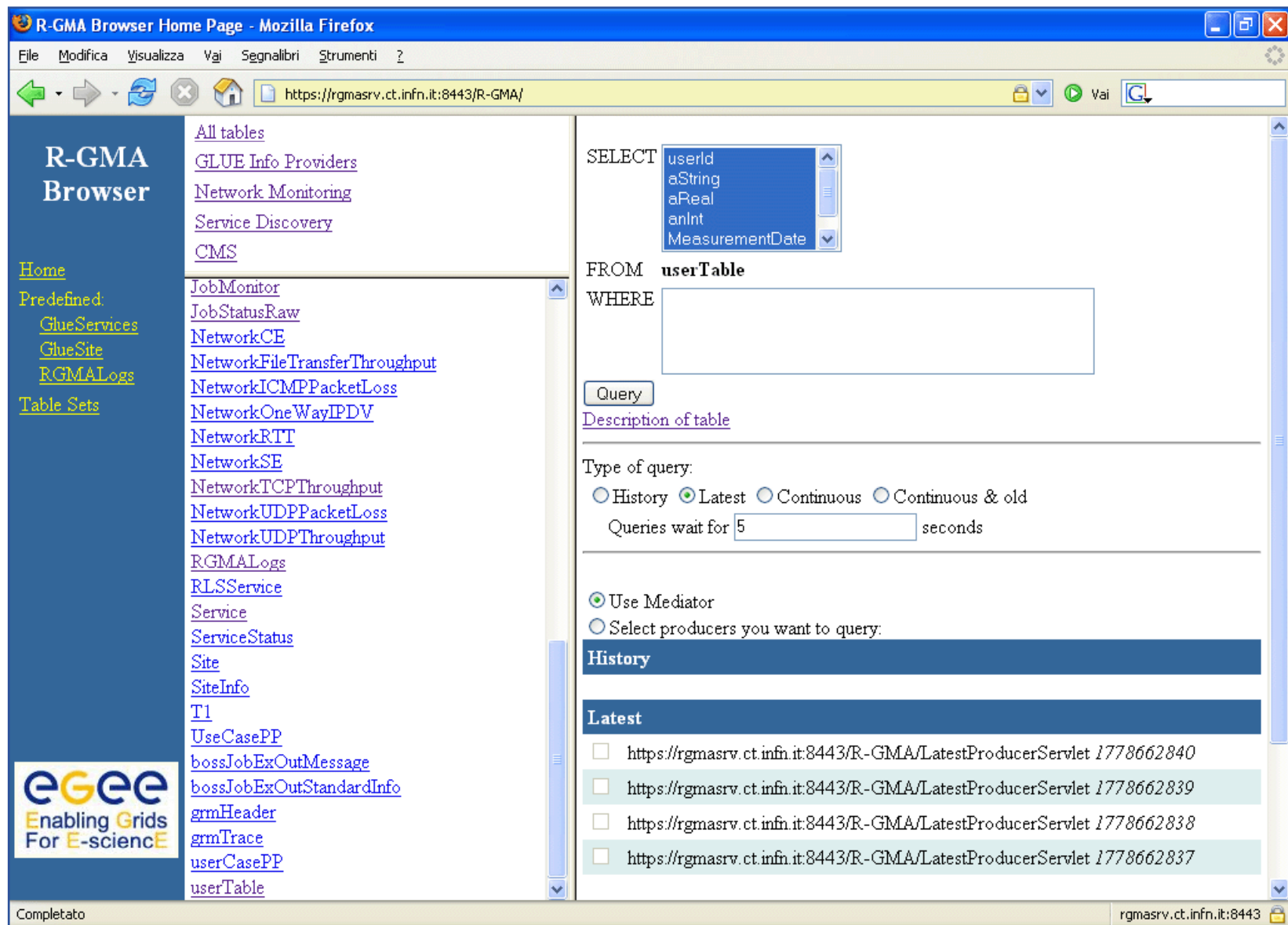

R-GMA Browser Home Page - Mozilla Firefox

File Modifica Visualizza Vai Segnalibri Strumenti ?

https://rgmasrv.ct.infn.it:8443/R-GMA/

R-GMA Browser

[All tables](#)

[GLUE Info Providers](#)

[Network Monitoring](#)

[Service Discovery](#)

[CMS](#)

[JobMonitor](#)

[JobStatusRaw](#)

[NetworkCE](#)

[NetworkFileTransferThroughput](#)

[NetworkICMPPacketLoss](#)

[NetworkOneWayIPDV](#)

[NetworkRTT](#)

[NetworkSE](#)

[NetworkTCPThroughput](#)

[NetworkUDPPacketLoss](#)

[NetworkUDPThroughput](#)

[RGMALogs](#)

[RLSService](#)

[Service](#)

[ServiceStatus](#)

[Site](#)

[SiteInfo](#)

[T1](#)

[UseCasePP](#)

[bossJobExOutMessage](#)

[bossJobExOutStandardInfo](#)

[grmHeader](#)

[grmTrace](#)

[userCasePP](#)

[userTable](#)

SELECT

FROM **userTable**

WHERE

Query

Description of table

Type of query:

History Latest Continuous Continuous & old

Queries wait for seconds

Use Mediator

Select producers you want to query:

History

Latest

- https://rgmasrv.ct.infn.it:8443/R-GMA/LatestProducerServlet 1778662840
- https://rgmasrv.ct.infn.it:8443/R-GMA/LatestProducerServlet 1778662839
- https://rgmasrv.ct.infn.it:8443/R-GMA/LatestProducerServlet 1778662838
- https://rgmasrv.ct.infn.it:8443/R-GMA/LatestProducerServlet 1778662837

Completato rgmasrv.ct.infn.it:8443

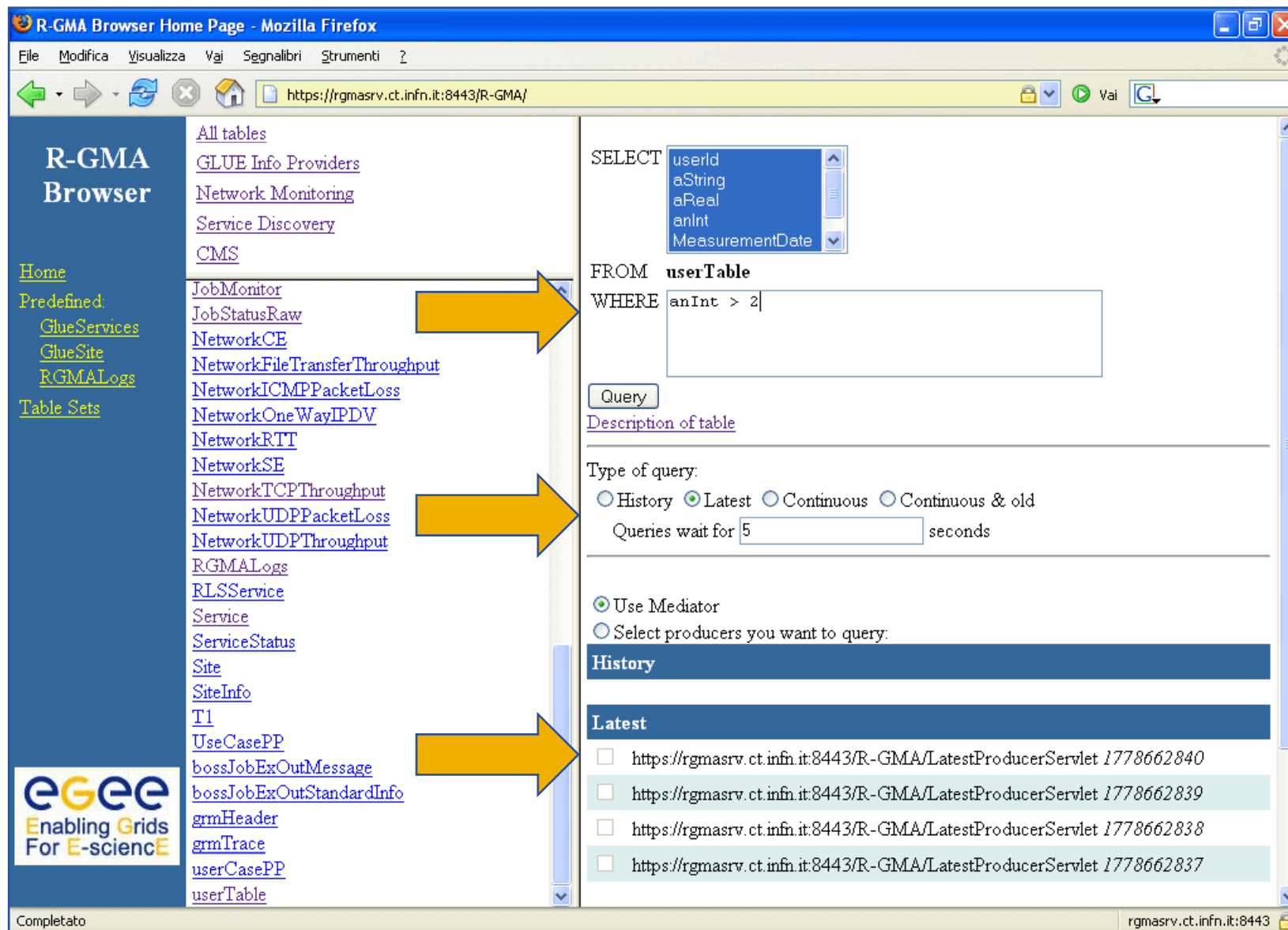

R-GMA Browser

Home

Predefined:

- GlueServices
- GlueSite
- RGMALogs

Table Sets

- All tables
- GLUE Info Providers
- Network Monitoring
- Service Discovery
- CMS
- JobMonitor
- JobStatusRaw
- NetworkCE
- NetworkFileTransferThroughput
- NetworkICMPPacketLoss
- NetworkOneWayIPDV
- NetworkRTT
- NetworkSE
- NetworkTCPThroughput
- NetworkUDPPacketLoss
- NetworkUDPTThroughput
- RGMALogs
- RLSService
- Service
- ServiceStatus
- Site
- SiteInfo
- T1
- UseCasePP
- bossJobExOutMessage
- bossJobExOutStandardInfo
- grmHeader
- grmTrace
- userCasePP
- userTable

SELECT

userId
aString
aReal
anInt
MeasurementDate

FROM userTable

WHERE anInt > 2

Query

Description of table

Type of query:

History Latest Continuous Continuous & old

Queries wait for 5 seconds

Use Mediator

Select producers you want to query:

History

Latest

- https://rgmasrv.ct.infn.it:8443/R-GMA/LatestProducerServlet 1778662840
- https://rgmasrv.ct.infn.it:8443/R-GMA/LatestProducerServlet 1778662839
- https://rgmasrv.ct.infn.it:8443/R-GMA/LatestProducerServlet 1778662838
- https://rgmasrv.ct.infn.it:8443/R-GMA/LatestProducerServlet 1778662837

Completato

rgmasrv.ct.infn.it:8443

R-GMA Browser Home Page - Mozilla Firefox

File Modifica Visualizza Vai Segnalibri Strumenti ?

https://rgmasrv.ct.infn.it:8443/R-GMA/

R-GMA Browser

[All tables](#)

[GLUE Info Providers](#)

[Network Monitoring](#)

[Service Discovery](#)

[CMS](#)

[AppIMONTT](#)

[GAMIAppStart](#)

[GlueBatchJob](#)

[GlueBatchQueue](#)

[GlueBatchSystem](#)

[GlueCE](#)

[GlueCEAccessControlBase](#)

[GlueCESEBind](#)

[GlueCluster](#)

[GlueHost](#)

[GlueHostLocalFileSystem](#)

[GlueHostNetworkAdapter](#)

[GlueHostPoolAccount](#)

[GlueHostProcess](#)

[GlueHostRemoteFileSystem](#)

[GlueHostRole](#)

[GlueSA](#)

[GlueSAAccessControlBase](#)

[GlueSE](#)

[GlueSEAccessProtocol](#)

[GlueSEAccessProtocolSup](#)

[GlueSL](#)

[GlueService](#)

[GlueServiceAssociation](#)

Query: `SELECT UniqueID, TotalCPUs, Status, MeasurementDate, MeasurementTime FROM GlueCE WHERE TotalCPUs > 2`

UniqueID	TotalCPUs	Status	MeasurementDate	MeasurementTime
glite-ce.ct.infn.it:2119/blah-pbs-short	16	Production	2006-01-25	09:27:22
egee008.cnaf.infn.it:2119/blah-pbs-long	4	Production	2006-01-25	10:01:23
egee008.cnaf.infn.it:2119/blah-pbs-infinite	4	Production	2006-01-25	10:01:23
egee008.cnaf.infn.it:2119/blah-pbs-short	4	Production	2006-01-25	10:01:23
glite-ce.ct.infn.it:2119/blah-pbs-infinite	16	Production	2006-01-25	09:27:22
lxcde01.pd.infn.it:2119/blah-pbs-long	6	Production	2006-01-25	09:36:15
lxcde01.pd.infn.it:2119/blah-pbs-short	6	Production	2006-01-25	09:36:15
lxcde01.pd.infn.it:2119/blah-pbs-infinite	6	Production	2006-01-25	09:36:15
glite-ce.ct.infn.it:2119/blah-pbs-long	16	Production	2006-01-25	09:27:22

Number of rows: 9

Wait for seconds

Completato rgmasrv.ct.infn.it:8443

- **R-GMA overview page.**
 - <http://www.r-gma.org/>
- **R-GMA in EGEE**
 - <http://hepunx.rl.ac.uk/egee/jra1-uk/>
- **R-GMA command line tool**
 - <http://hepunx.rl.ac.uk/egee/jra1-uk/glite-r1/command-line.pdf>
- **R-GMA Browser Home Page**
 - <https://rgmasrv.ct.infn.it:8443/R-GMA/>