

LARP

US LHC Accelerator Research Program

BNL - FNAL - LBNL - SLAC

LARP Contributions to LHC Phase II Collimation

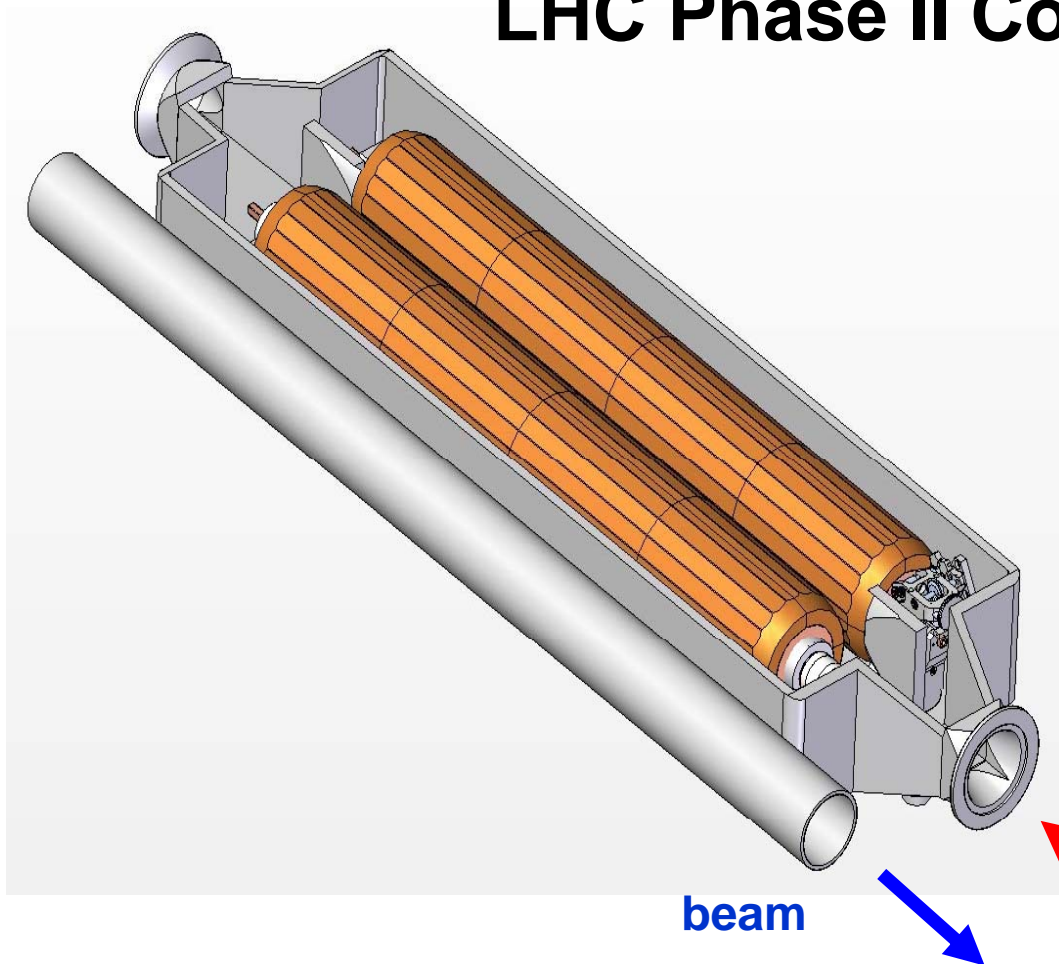

01 October 2007
Beam'07 - CERN
Tom Markiewicz/SLAC
beam

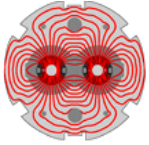

LARP

Three of Four LARP Collimation Program Tasks: Address Phase II Collimation

SLAC: Study, design, prototype and test a collimator design based on SLAC NLC “Rotatable” concept that can be dropped into 30 reserved lattice locations as a part of the “Phase II Collimation Upgrade” required if the LHC is to reach its nominal $1E34$ luminosity

BNL (N. Simos et al): irradiate and then measure the properties of the materials that will be used for phase 2 collimator jaws

Fermilab (N. Mokhov et al): Activation of Phase II Collimators

LARP Collimator Tasks Also Address Phase I Collimation Issues:

- Fermilab: Understand and improve the design of the **tertiary collimation** system that protects the LHC final focusing magnets and experiments
- BNL: Studies of the **properties of irradiated Phase I materials (C-C)**
- BNL (A. Drees et. al): Use **RHIC data to benchmark the code** used to predict the cleaning efficiency of the LHC collimation system and develop and test algorithms for setting collimator gaps that can be applied at the LHC

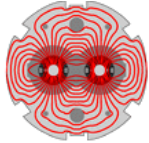

LARP

SLAC Timeline for RC=Rotatable Collimator Prototype

Gene Anzalone, Yunhai Cai, Eric Doyle, Lew Keller,
Steve Lundgren, Tom Markiewicz, **Jeff Smith**

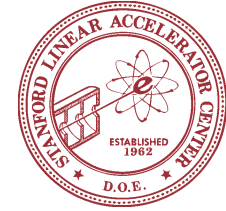

- 2004: Introduction to project
- 2005: Conceptual Design Phase II RC using FLUKA, Sixtrack and ANSYS, External Design Review, collimator test lab set up
- 2006 Improved Conceptual Design, hire full time ME and designer, fabricate tooling, 2D/3D drawings of test and final parts, braze two short test pieces
- 2007: Examine test brazes, braze and examine 3rd short test piece, develop and build rotation mechanism, design RF shield, fab 1st full length jaw; hire first postdoc
- 2008 Thermal tests of single jaw, fabricate two more jaws and assemble into a vacuum tank compatible with Phase I adjustment mechanism = RC
- 2009: Mechanically test RC, ship and install in SPS/LHC
- 2010: Collimator tests at LHC & Final drawing package for CERN
- 2011: Await production & installation of chosen design(s) by CERN
- 2012: Commissioning support

Main Deliverables

Thermal tests of single collimator jaw

Construct and mechanically test full RC prototype to be sent to CERN

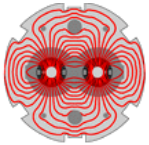

LARP

NLC Consumable Collimator

rotatable jaws – 500 to 1000 hits

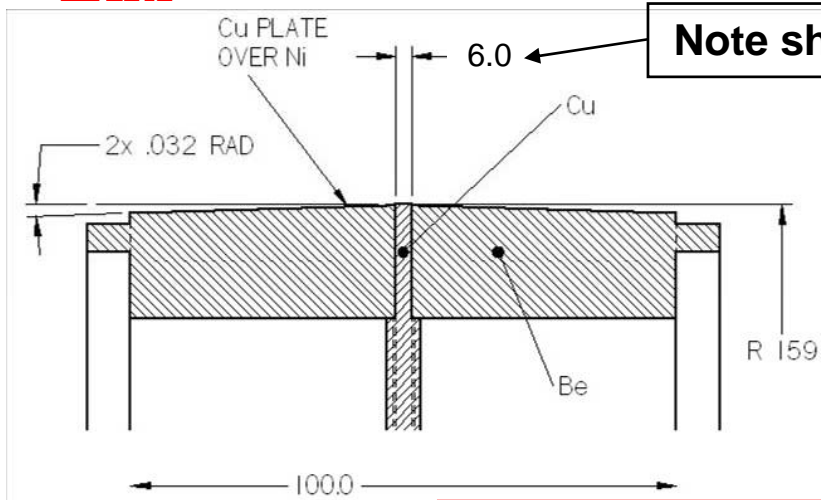

**< 10 W per jaw
=>radiative cooling!**

Aperture control mechanism – 5 μ m accuracy & stability



Alignment BPMs upbeam & down

Movers align chamber to beam based on BPMs

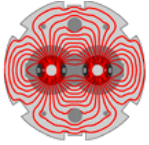

LARP

LHC Phase II Base Concept

physical constraints
current jaw design

- beam spacing: geometrical constraint
- Length available 1.47 m flange - flange
- Jaw translation mechanism and collimator support base: LHC Phase I
- **>10 kW per jaw Steady State heat dissipation (material dependent)**

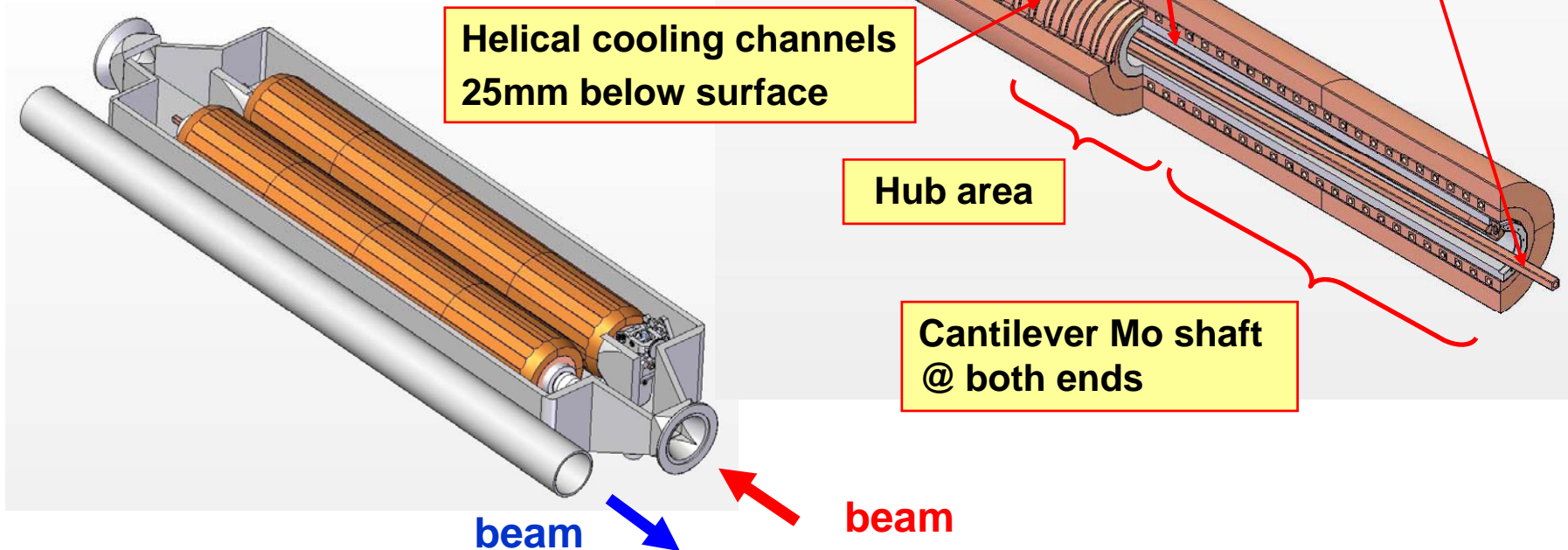

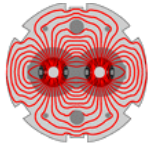

LARP

LHC Collimation Requirements

LHC Beam Parameters for nominal $L=1E34\text{cm}^{-2}\text{s}^{-1}$:

- 2808 bunches, $1.15E11$ p/bunch, 7 TeV \rightarrow 350 MJ
- $\Delta t=25\text{ns}$, $\sigma\sim 200\mu\text{m}$ (collisions)

System Design Requirement:

- Protect against quenches as beam is lost
 - “Steady state” collimator cooling for $\tau = 1$ hour or $8E10$ p/s or 90kW
 - “Transient” bursts of $\tau = 12$ min or $4E11$ p/s or 450kW
 - abort if lasts > 10 sec
- Accident Scenario : Beam abort system fires asynchronously with respect to abort gap - **8 full intensity bunches** impact collimator jaws

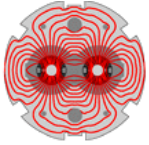

Dominant collimator specifications

LARP

- 25 μm maximum deformation toward beam
- 7 σ nominal aperture
 - The first long secondary collimator may be set at 8 σ to ensure 25 μm intrusion with respect to 7 σ
- 45 mm minimum aperture jaws fully retracted
- Beam spacing limits transverse dimensions
- Maximum length predetermined: 1.48 m flange-flange
- No water-vacuum joints

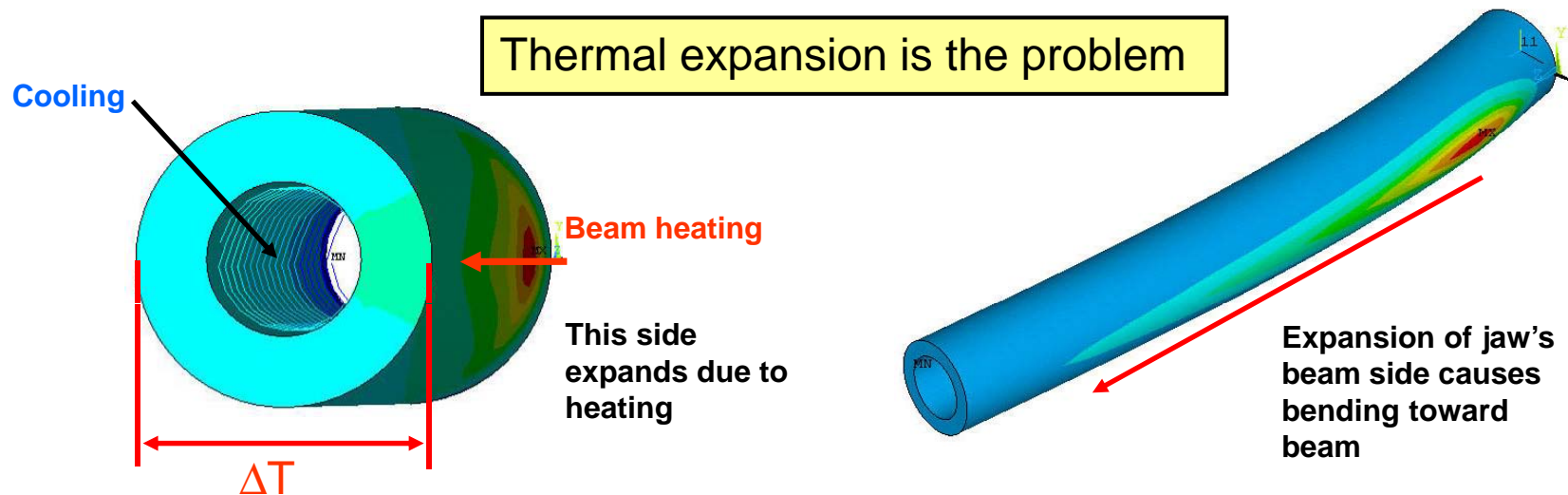

This effect is a function of material, jaw OD & ID, length, and cooling arrangement

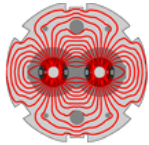

LARP

Yunhai Cai

SIXTRACK simulation

compare materials' collimation efficiency
tradeoff with mechanical performance

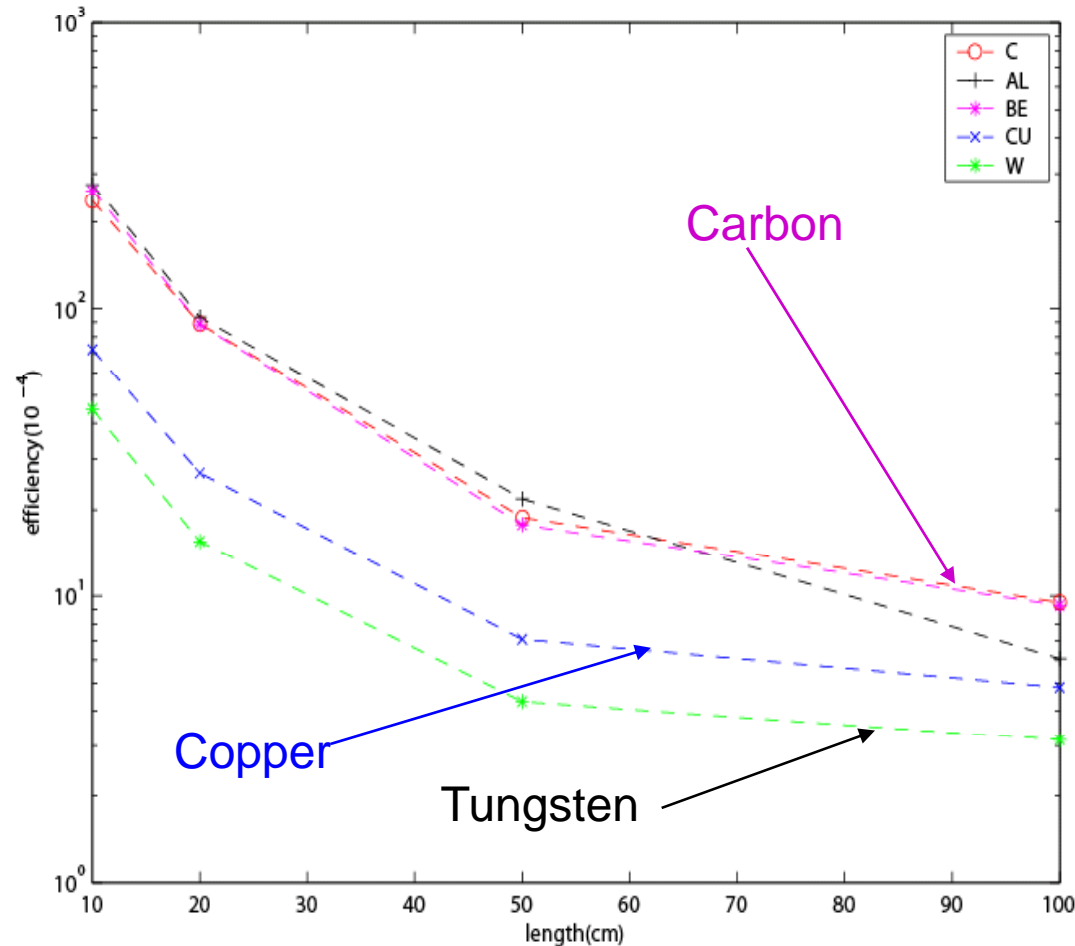

- High Z materials improve system efficiency but generate more heat

- Copper considered because its high thermal conductivity and ease of fabrication

- Available length for jaws is about 1 meter

Similar result was obtained by Ralph Aßmann

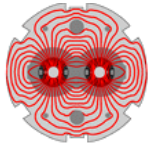

LARP

FLUKA Results - Power Deposited vs. Length

- 1st secondary collimator

- Various materials

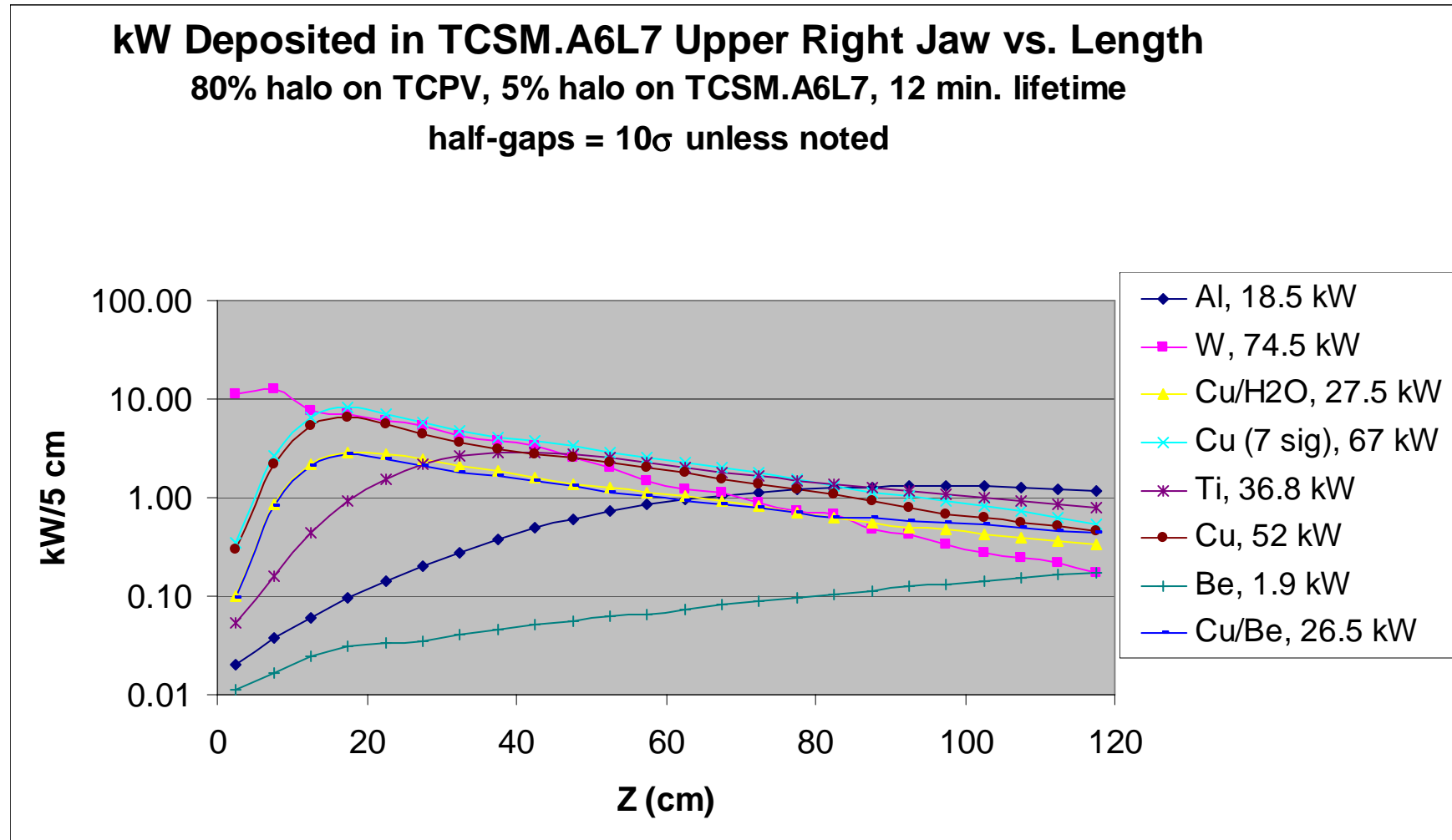



Basis for Design Choices

ANSYS Thermal/Mechanical simulations using FLUKA energy deposit

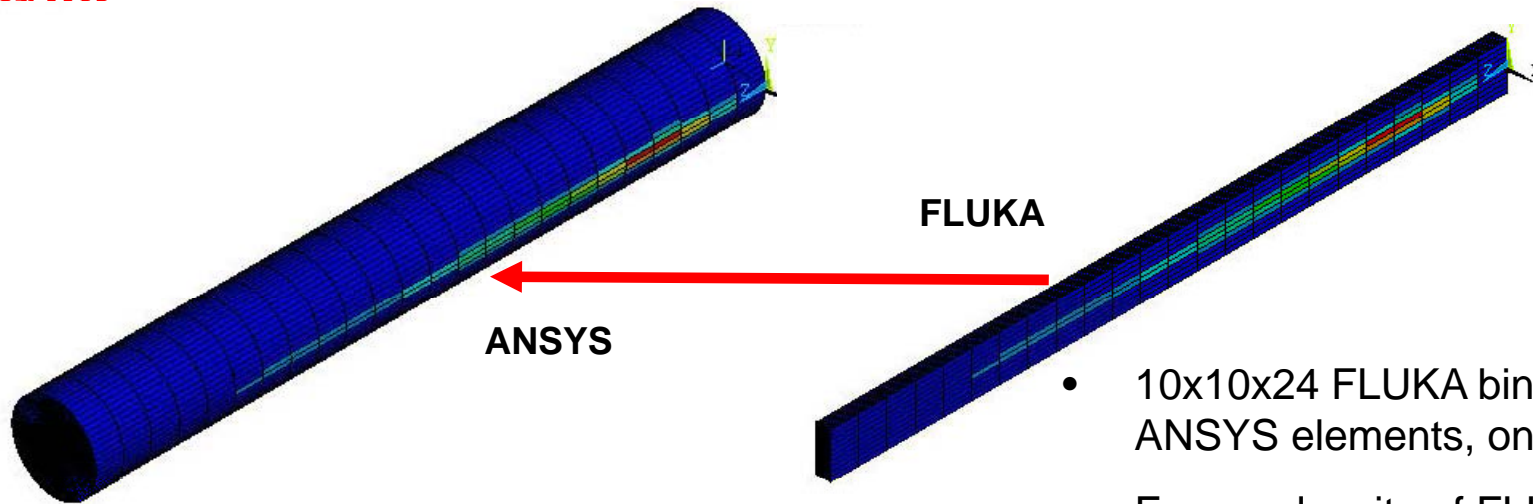

- 10x10x24 FLUKA bins mapped to ANSYS elements, one for one
- Energy density of FLUKA bin applied to ANSYS element

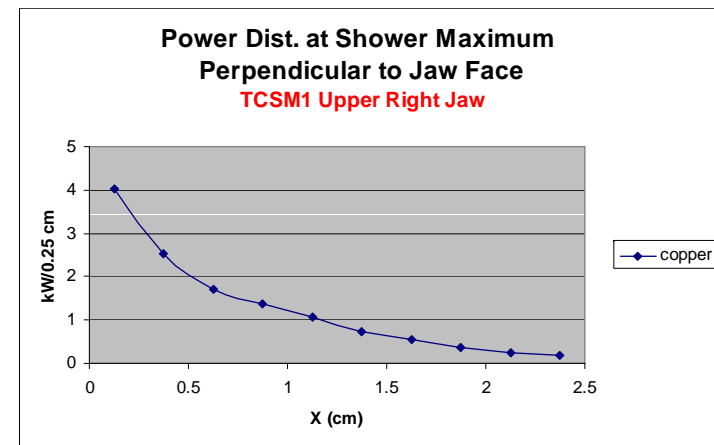
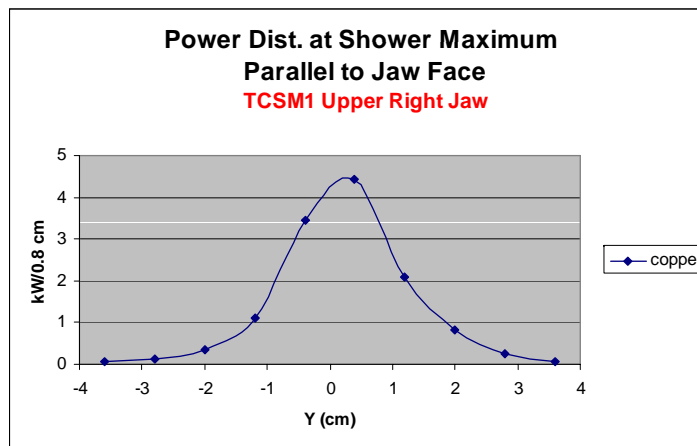
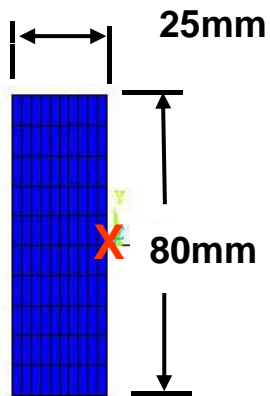

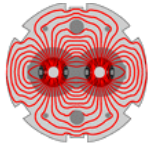

LARP

Material thermal performance

- Hollow Cylinder Model
- O.D = 150 mm, I.D. = 100 mm, L = 1.2 m
- NLC-type edge supports
- aperture 10σ

10 σ , primary debris + 5% direct		SS @ 1 hour beam life					transient 10 sec @ 12 min beam					
material	cooling arc (deg)	power (kW) per jaw	Tmax (C)	(defl (um)	Tmax water side(C)	max flux (W/m^2)	power (kW)	Tmax (C)	(defl (um)	Tmax water side(C)	max flux (W/m^2)	
Al	360	3.7	33	143			18.5	73	527			
2219 Al	360	4.6	34	149	26	7.1E+04	23	79	559	46	3.1E+05	
BeCu (94:6)	360	0.85	24	20			4.3	41	95			
C R4550	360	0.6	25	5			3.0	41	20			
→ Cu	360	10.4	61	221	43	2.7E+05	52	195	829	117	1.2E+06	
Cu - 5mm	360	4.5	42	117	39	2.3E+05	22.4	129	586	117	1.2E+06	
Cu/Be (5mm/20mm)	360	5.3	53	161								
Super Invar	360	10.8	866	152 ¹	60							
Inconel 718	360	10.8	790	1039	66		54	1520	1509	85		
Titanium	360	7.4	214	591	42		36.8	534	1197	77		
Tungsten (.48 m L)	360	13.5	183	95	79		67.5	700	335	240 ²	2.6E+06	
Al - solid core	}	36	3.7	40.8	31		18.5	80	357			
2219 Al		36	4.6	43	31		23	89	492			
BeCu (94:6) *		36	0.85	27	2		4.3	46	101			
Cu		36	10.4	89	79	67	5.6E+05	52	228	739	139	1.4E+06
Cu - solid core		36	10.4	85	60	65	5.3E+05	52	213	542	120	1.2E+06

1. deflection not valid, super invar loses its low c.t.e. at 200C
2. pressure > 30 bar needed to suppress boiling

* Promising but no practical implementation

Cu chosen – balance of efficiency, deflection and manufacturability

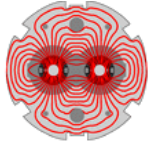

LARP

Justification of Cu Choice

Material evaluations

material	reasons for rejection in favor of Cu
Aluminum	relatively poor cleaning efficiency, water channel fabrication difficulty
BeCu (6% Cu-loaded Be)	(Note: an imaginary metal - unknown fabrication difficulties) Be is strongly discouraged by CERN policy; low cleaning efficiency.
Cu - 5mm wall	deflection only ~50% lower than 25mm Cu; loss of safety zone between the beam and water channels
Cu/Be (5mm/20mm bonded)	deflection only ~30% lower than 25mm Cu; Be prohibition; fabrication difficulty
Inconel 718	poor thermal conductivity => high temperature & very high deflection (1039um SS, 1509um transient)
Super Invar	poor thermal conductivity => high temperature 4X higher than temp at which low thermal expansion coefficient disappears.
Titanium	poor thermal conductivity => deflection 2.7 x Cu (591um, SS)
Tungsten	High temperature on water side (240C => ~30bar to suppress boiling); high power density - can't transfer heat without boiling; fab difficulty

Cu chosen as best balance between collimation efficiency, thermal distortion & manufacturability

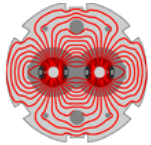

LARP

June 2006

Introduce new **jaw-hub-shaft** design which eliminates central stop & flexible springs

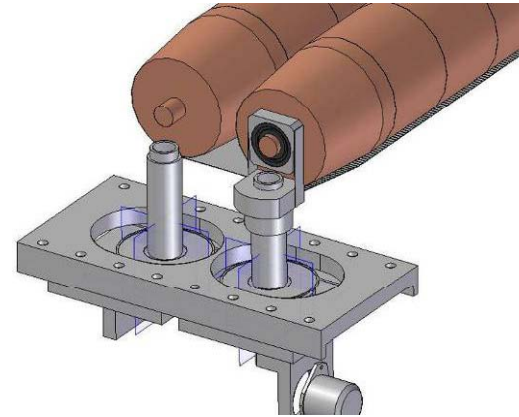
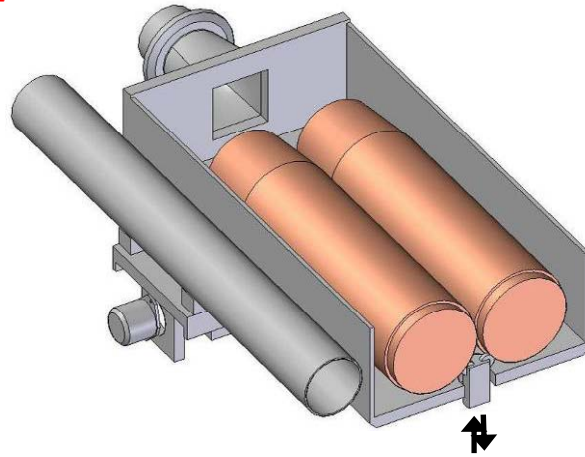
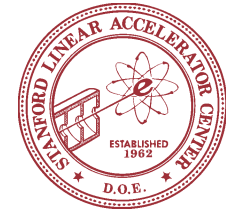

x5 improvement in thermal deformation
1260 μm \rightarrow 236 μm (60kW/jaw, $\tau=12\text{min}$)
426 μm \rightarrow 84 μm (12kW/jaw, $t=60\text{min}$)

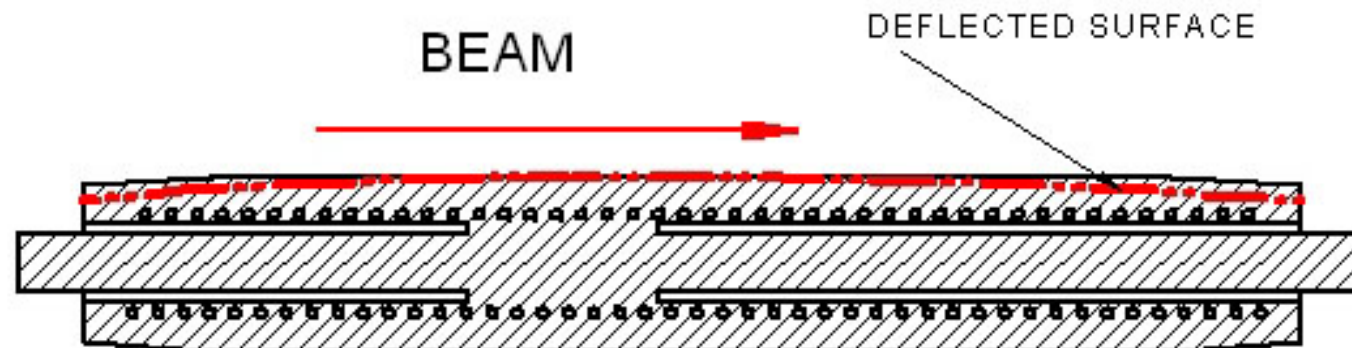
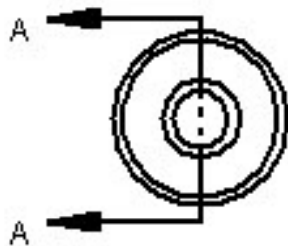

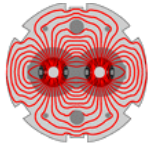

LARP

June 2006

Introduce new **reverse-bend winding concept** for the cooling coil which **eliminates the 3 end loops**, permitting longer jaws and freeing up valuable space for jaw supports, rotation mechanism and RF-features

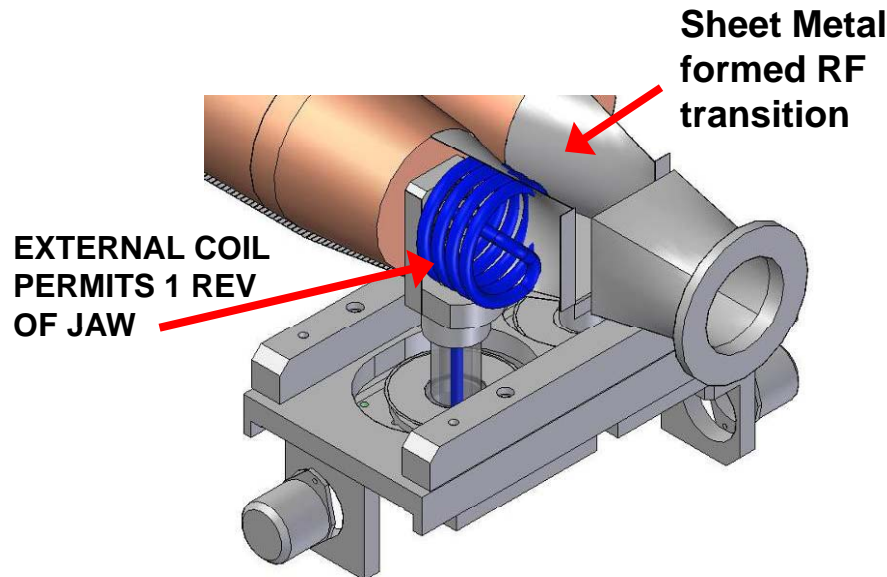
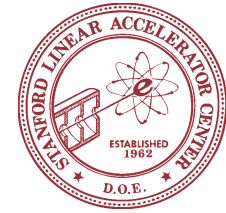

4-1/2 Turns without failure

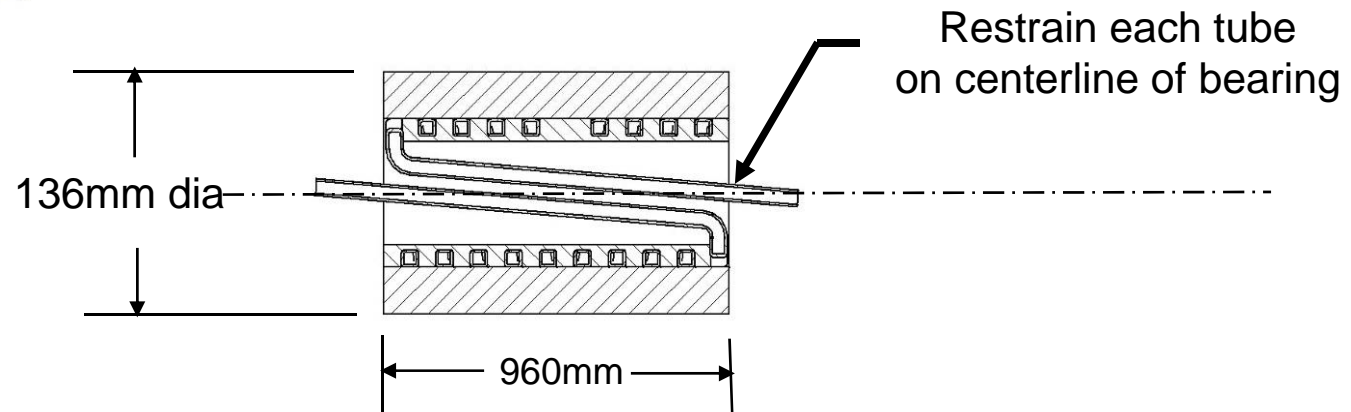

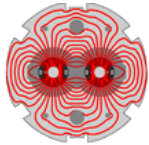

LARP

Comparison of Hollow **Moly shaft** and Solid Copper Shaft to same FLUKA secondaries: Improved deflections

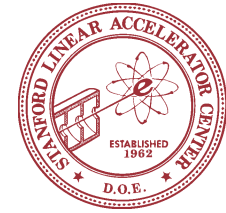

	Solid Cu, 75cm tapered jaw, asymmetric hub		Tubular Moly, 95 cm straight jaw, symmetric hub	
	Steady State $\tau=1$ hour	$\tau = 12$ min for 10 sec	Steady State $\tau=1$ hour	$\tau = 12$ min for 10 sec
Gravity sag	200 μm		67.5 μm	
Power absorbed	11.7 kW	58.5 kW	12.9 kW	64.5 kW
Peak Temp.	66.3 $^{\circ}\text{C}$	197 $^{\circ}\text{C}$	66 $^{\circ}\text{C}$	198 $^{\circ}\text{C}$
Midjaw Δx	100 μm	339 μm	83.6 μm	236 μm
Effective Length	51 cm	25 cm	74 cm	39 cm
Sagitta	221 μm	881 μm	197 μm	781 μm

Accident Case

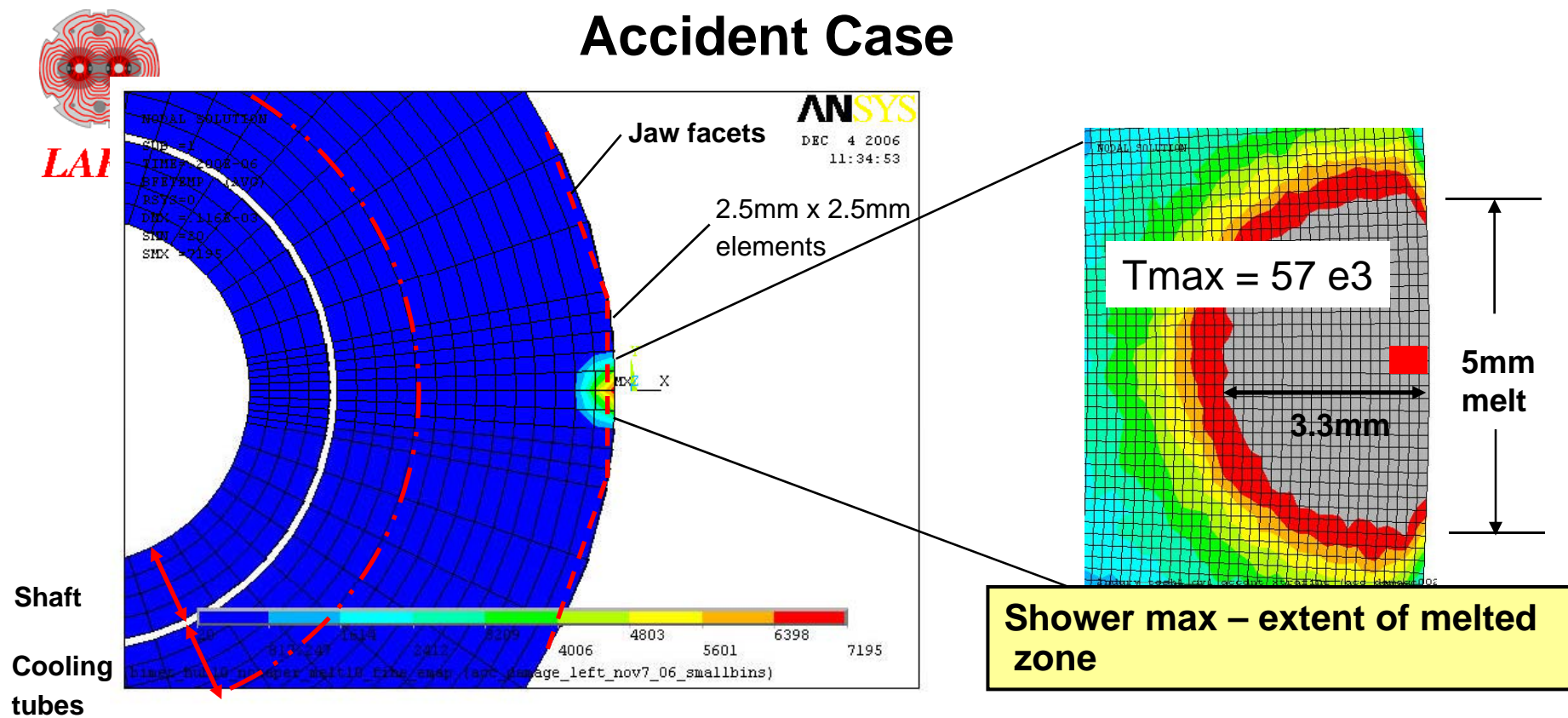

Case: beam abort system fires asynchronously, **8 full intensity bunches into jaw**

Model: - increased resolution 3-D ANSYS & FLUKA models

- Thermal heating/cooling analysis followed by quasi-static stress analysis
- Jaw ends constrained in z during 200 ns, released for 60 sec cool-down
- 0.27 MJ deposited in 200 ns
- Molten material removed from model after 200 ns

Result: - 57e3 peak temperature (ultra fine model)

- **54 μ m permanent deformation** (concave)

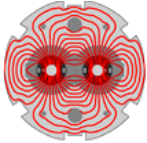

LARP

Accident Case

Permanent Jaw deflection, ux, after 60 sec cool-down

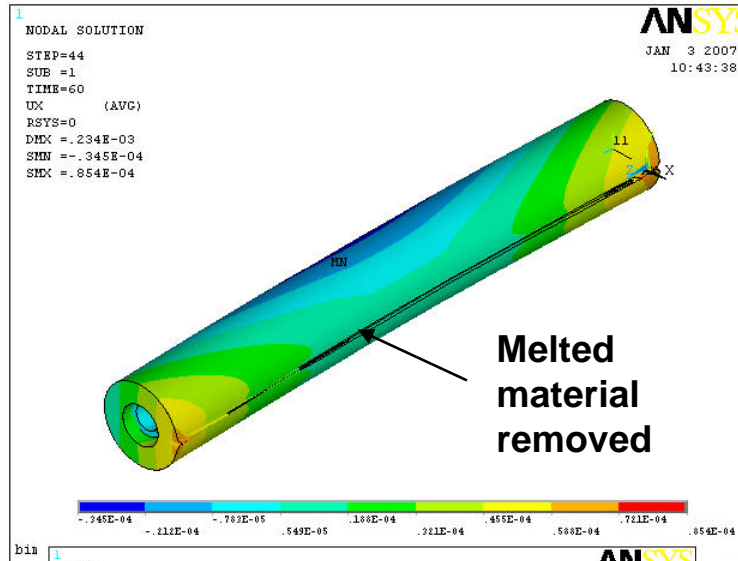
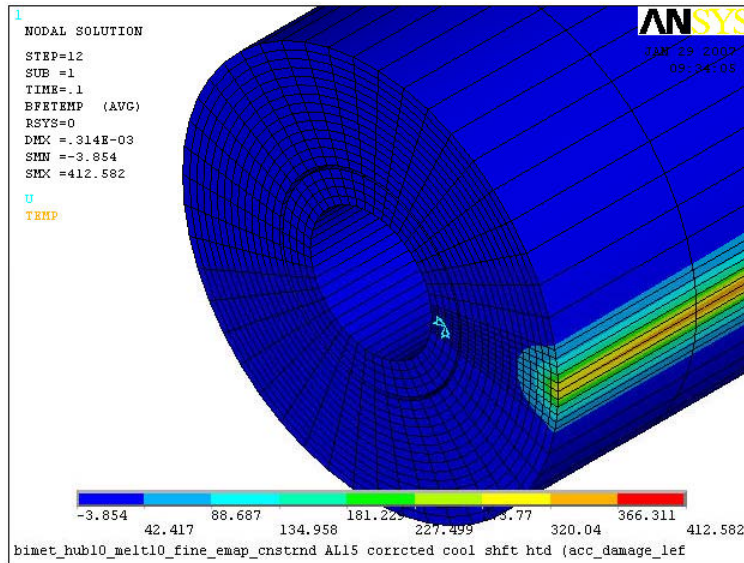

After energy deposit (200ns – 60 sec), z-constraints released. Original analysis used this constraint at all times.

- What happens to vaporized/melted material?
- How to use deformed jaw?

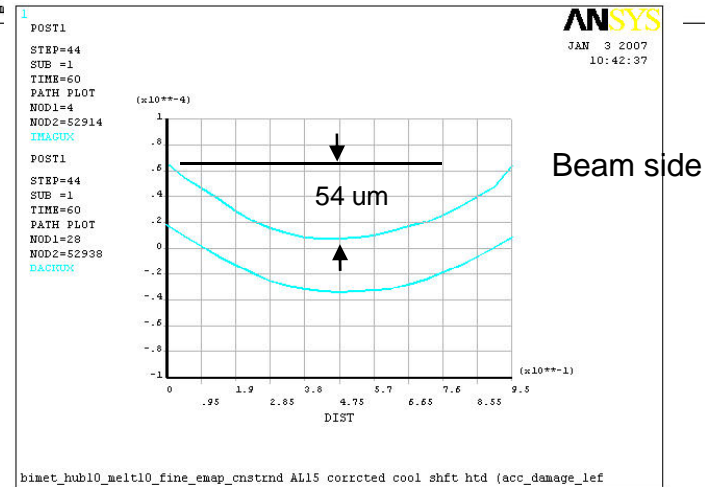

In-plane permanent deflection



Introduce new **Internally actuated drive and jaw mount** for rotating after beam abort damages surface
Completed 27 May 2007

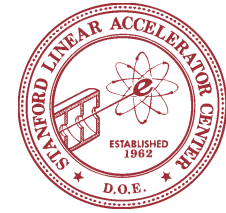

Universal Joint Drive Axle Assembly

- Thermal expansion
- Gravity sag
- Differential transverse displacement

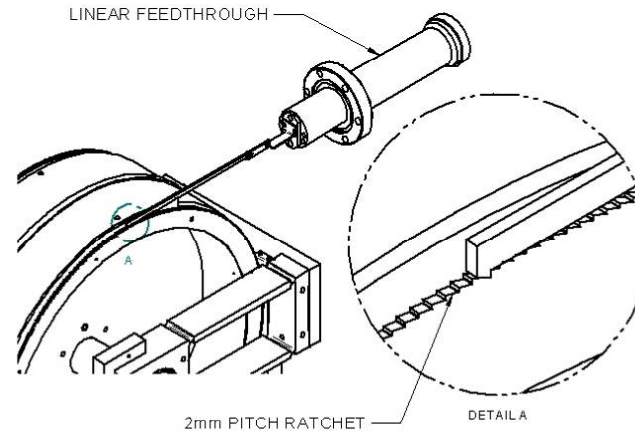
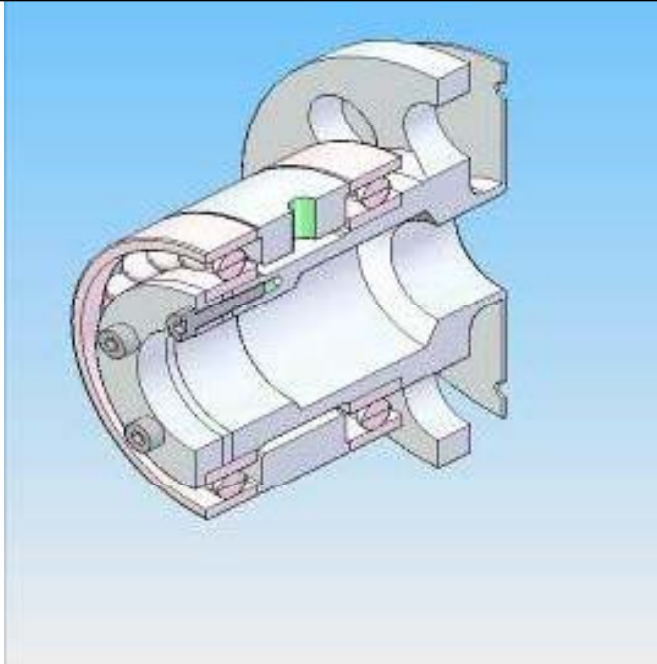

NLC Jaw Ratchet Mechanism

New rotation drive with "Geneva Mechanism"

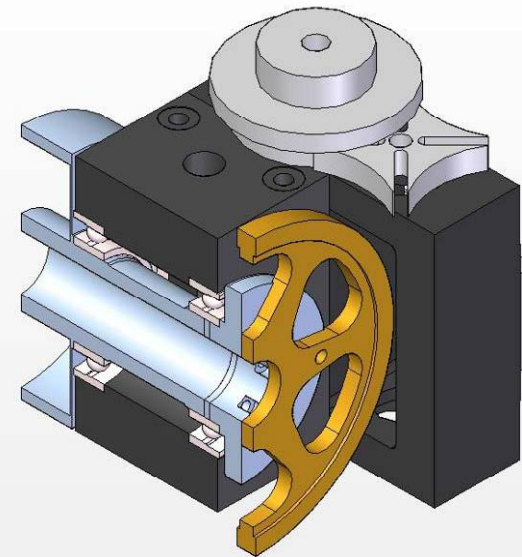

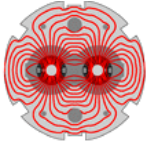

LARP

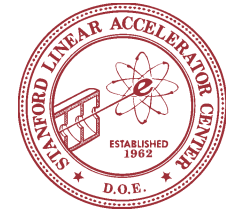

Upstream end vertical section

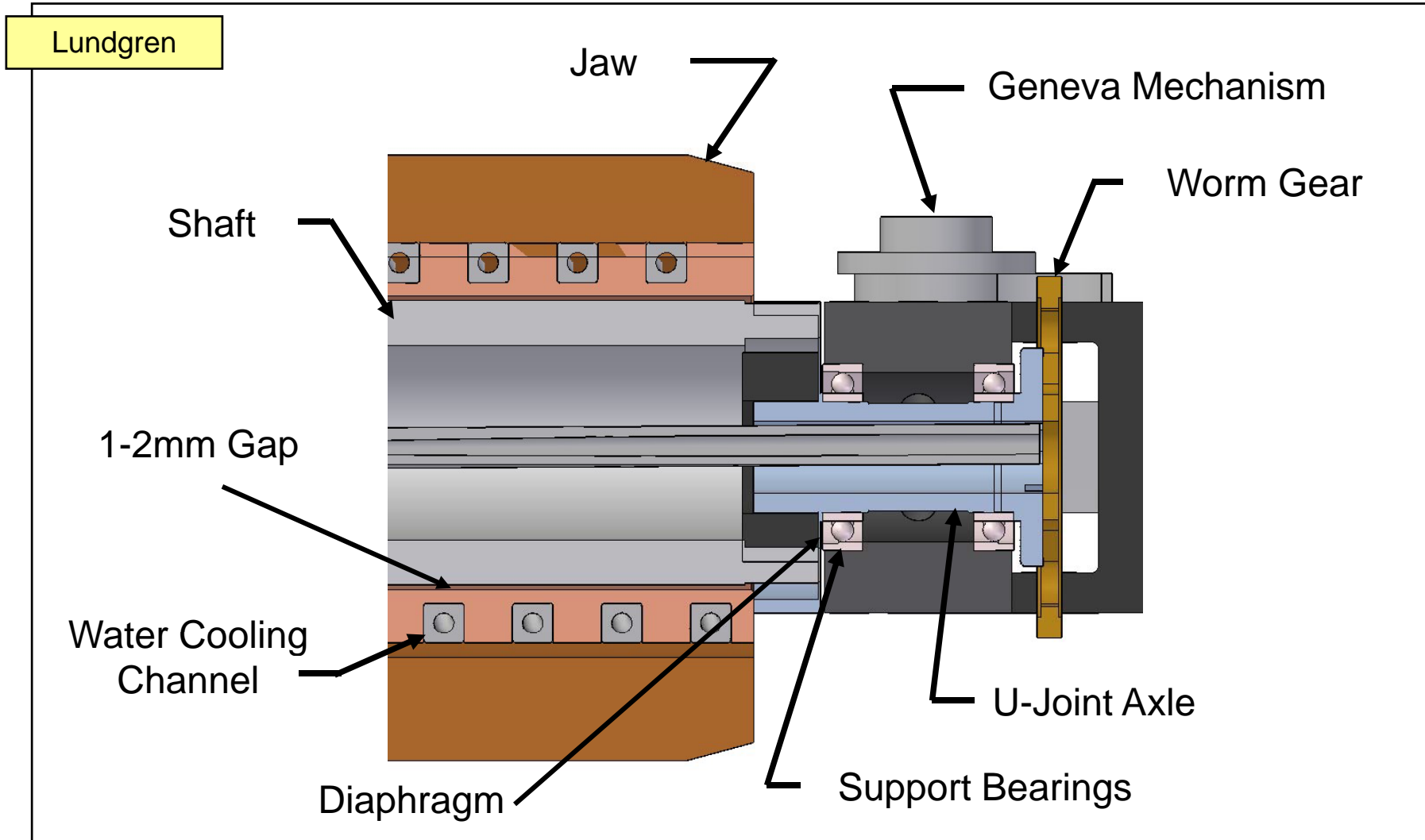

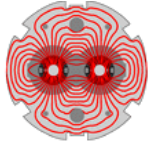

LARP

RF and Image Current Shielding

ONLY PART OF DESIGN THAT REMAINS TO BE FINALIZED

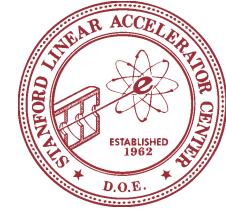

Current Concept:

- Transition from round beam pipe id to 58mm square geometry is built into tank ends.
- A thin sheet metal “curtain” bridges to the “Transition Socket”.
- The “Transition Socket” mates with the Jaw’s flexible spherical end.
- Paired spiral style RF springs balance the loading on the RF “Sheath”.

In Progress (Jeff Smith):

- Discussions with CERN and PeP-II experts
- MAFIA simulations
 - Geometric versus resistive contributions

To be done:

- Impedance measurements with network analyzer
- Contact resistance measurements

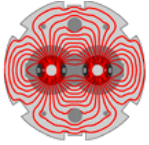

LARP

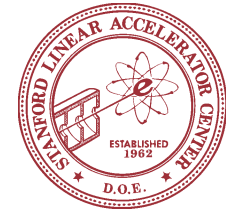

Up Beam end beam side view

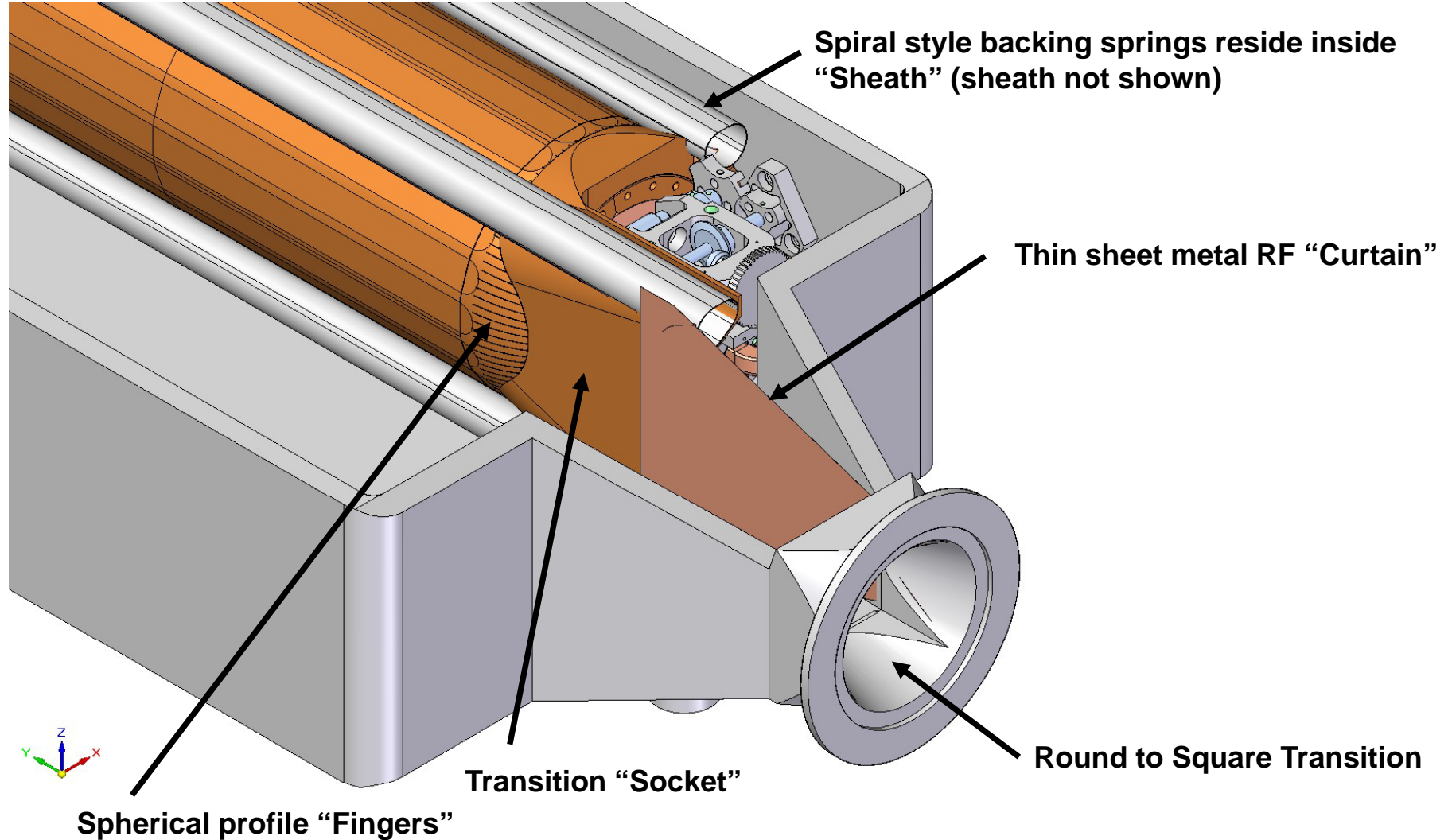

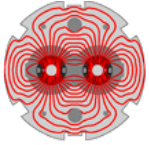

LARP

Up Beam end detail view away from beam side

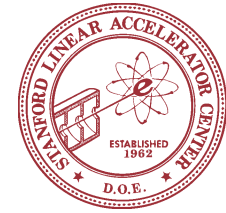

2 cam buttons (not shown) lift “Socket” off “Fingers” during Jaw rotation and rest in detents during collimation

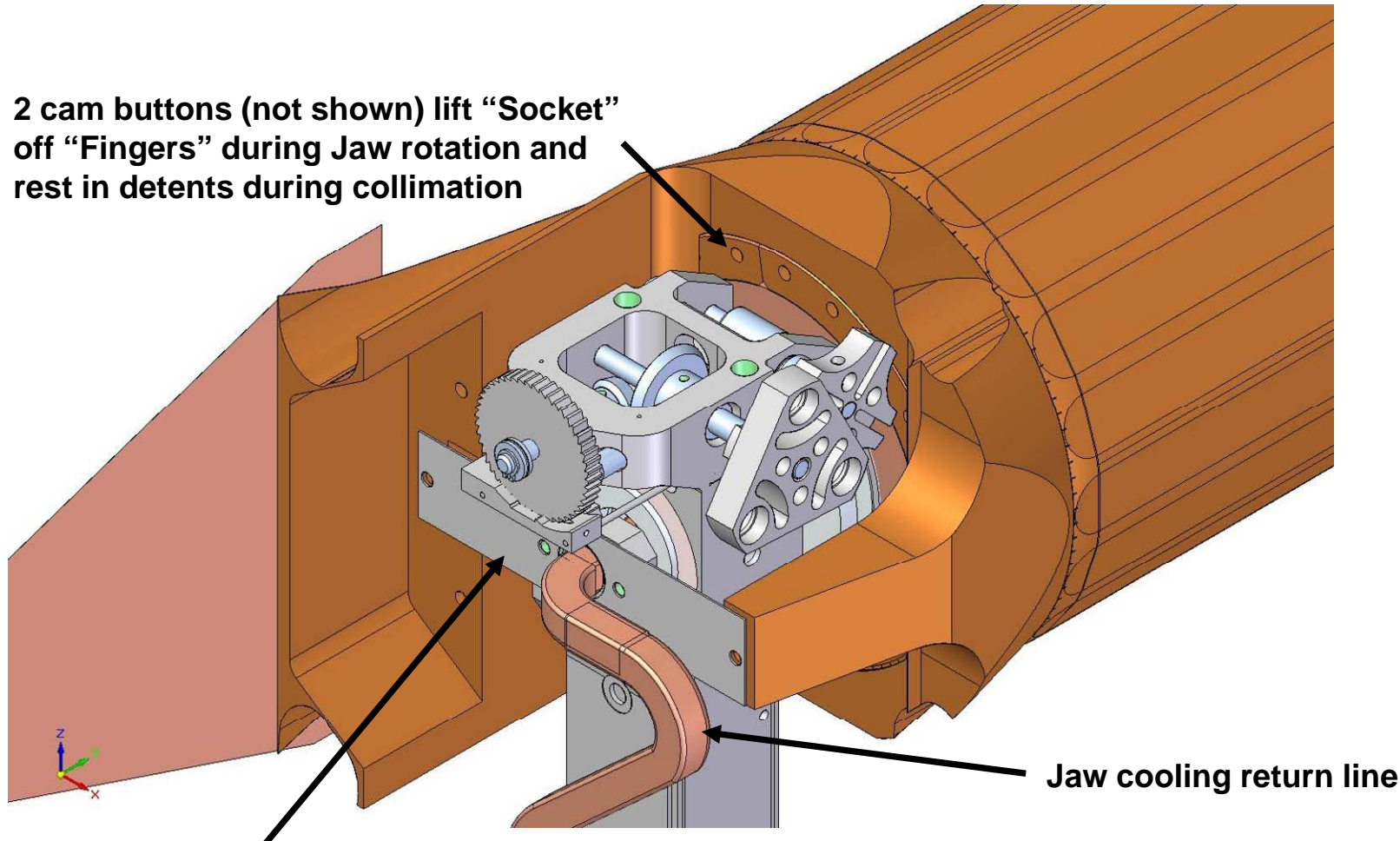

Jaw cooling return line

Spring flexes to maintain contact force on “Fingers” for longitudinal and lateral displacements of the Jaw ends

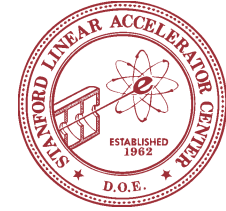

“Sheath” concept for transverse RF seal

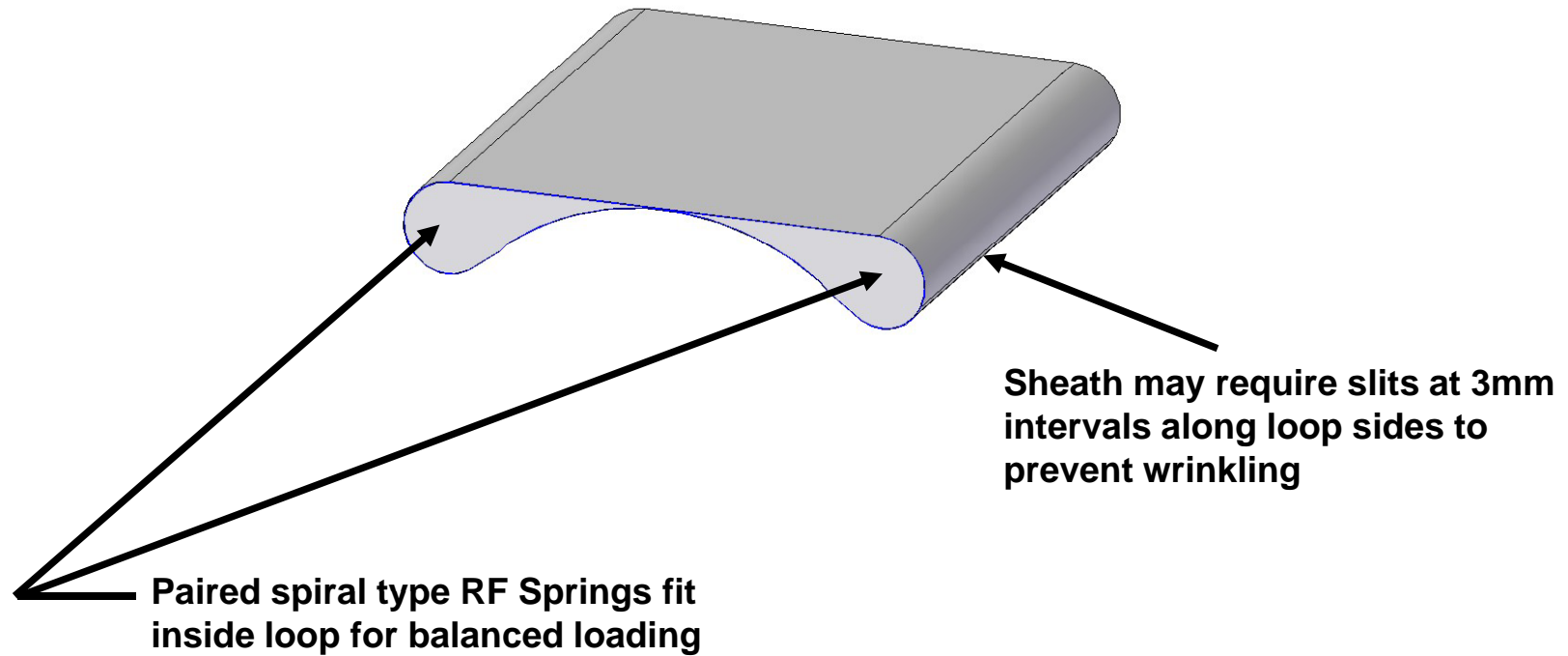

BrazeTest #1 (May 2006)

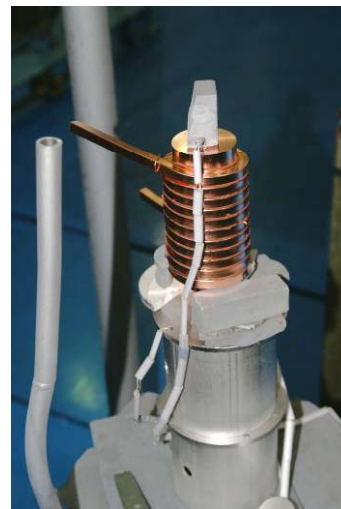
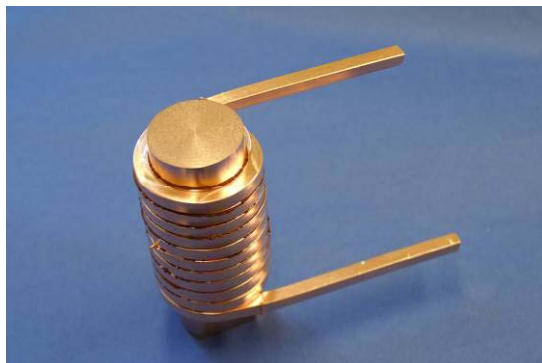
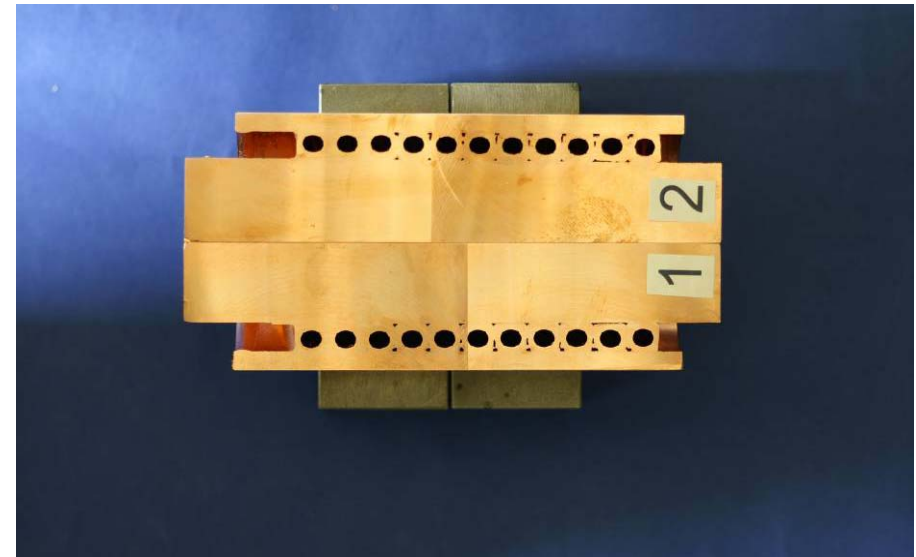
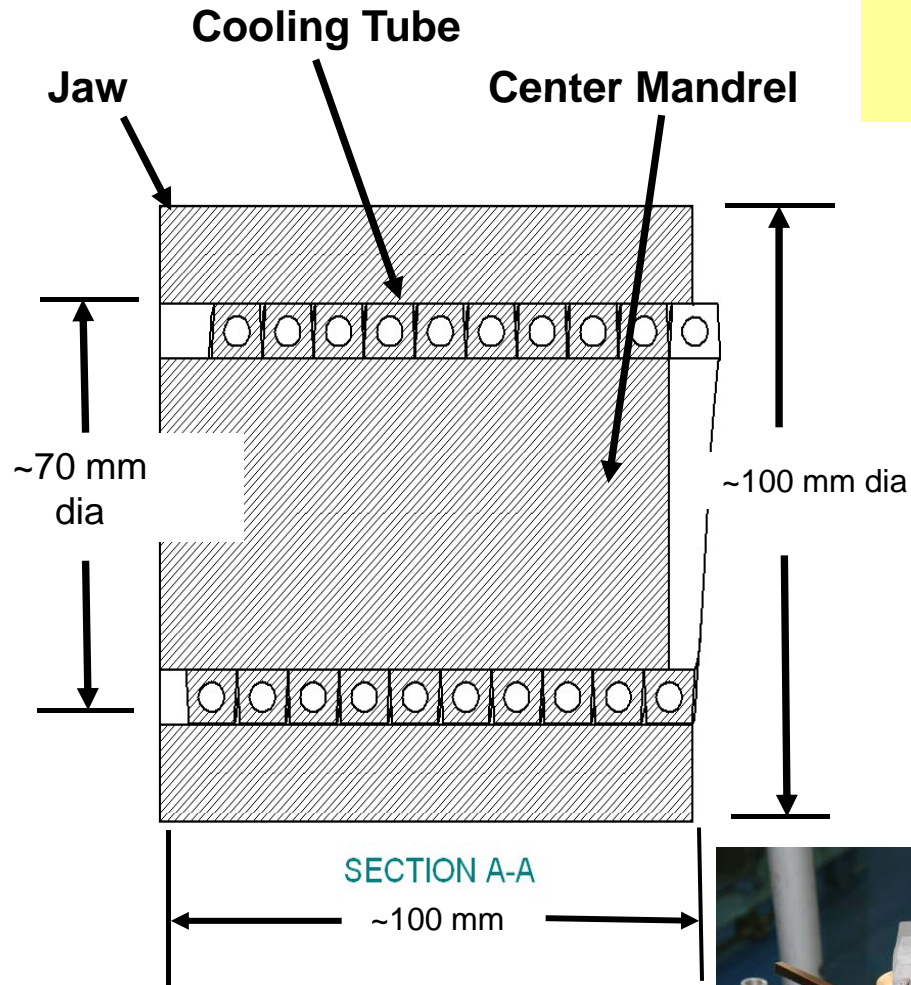
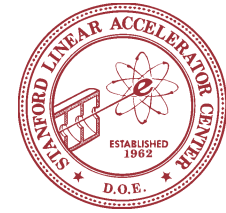

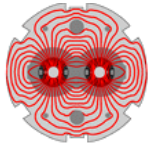

LARP

Development of Winding Tooling

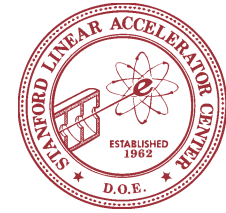

Aluminum Mandrel with Coil Wound

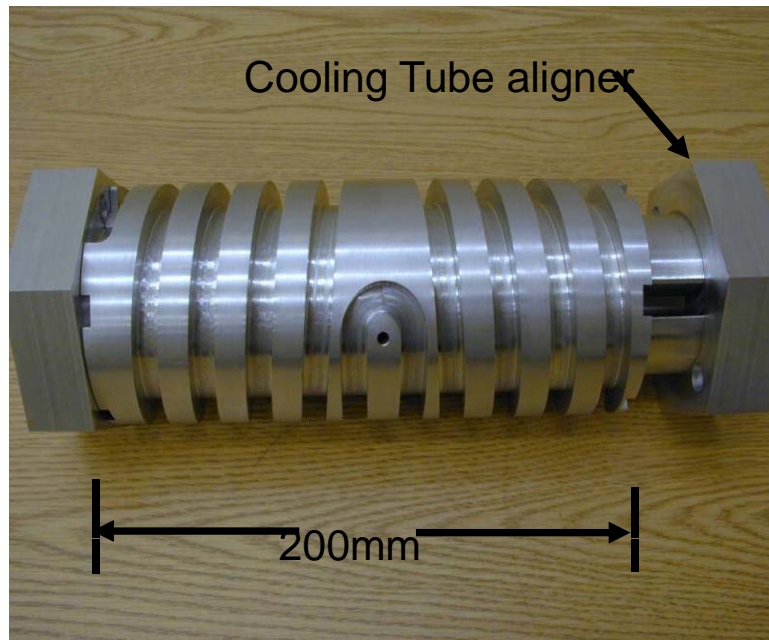

Aluminum Mandrel for Coil Winding Test and to test 3-axis CNC Mill before cutting 200mm and 950mm Copper Mandrels

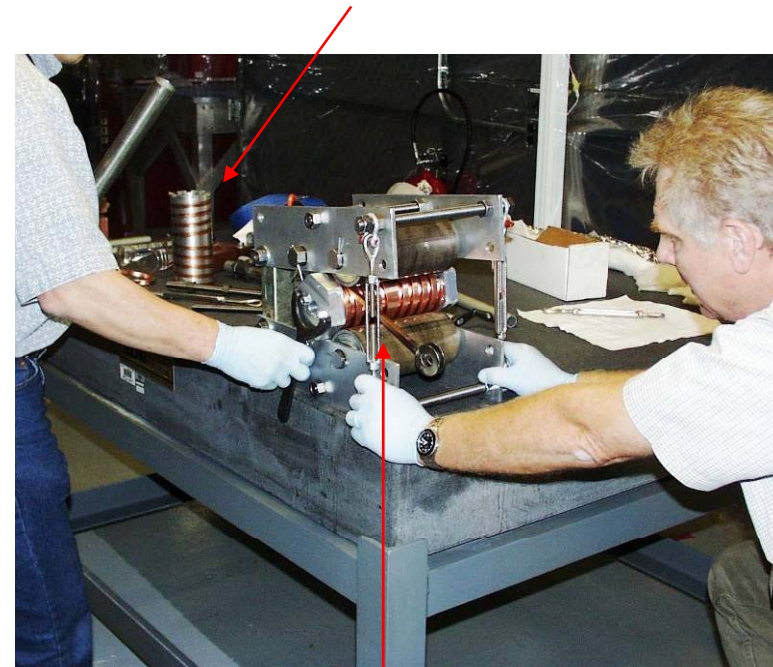

Roller-Type Coil Winding Tool used to test wind the 200mm Copper Mandrel



Fabrication of Quarter Jaws for 2nd Braze Test

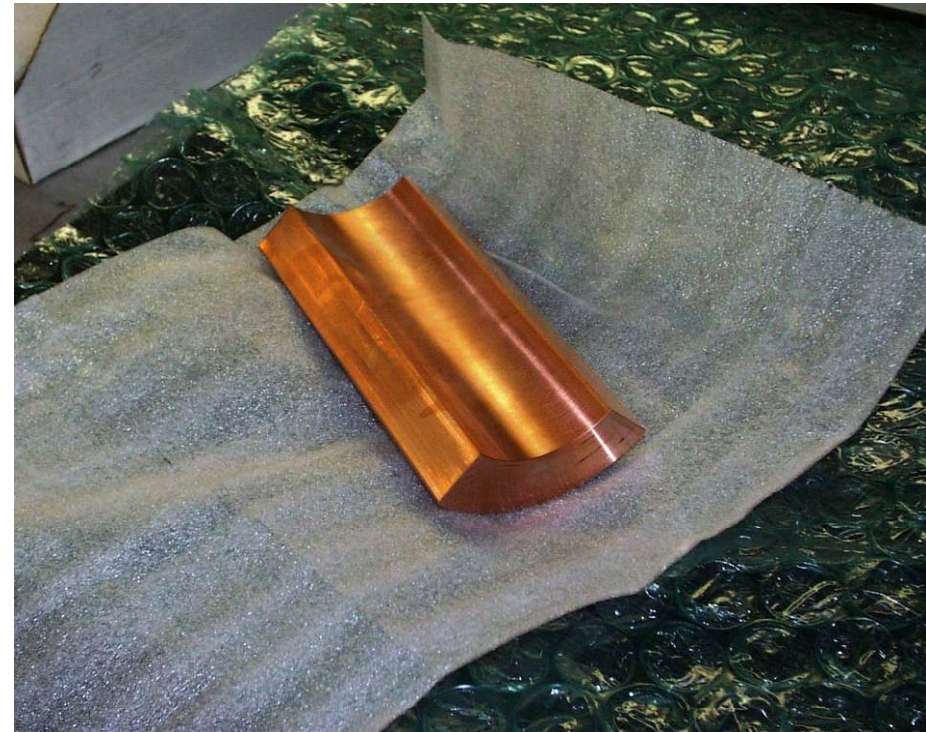
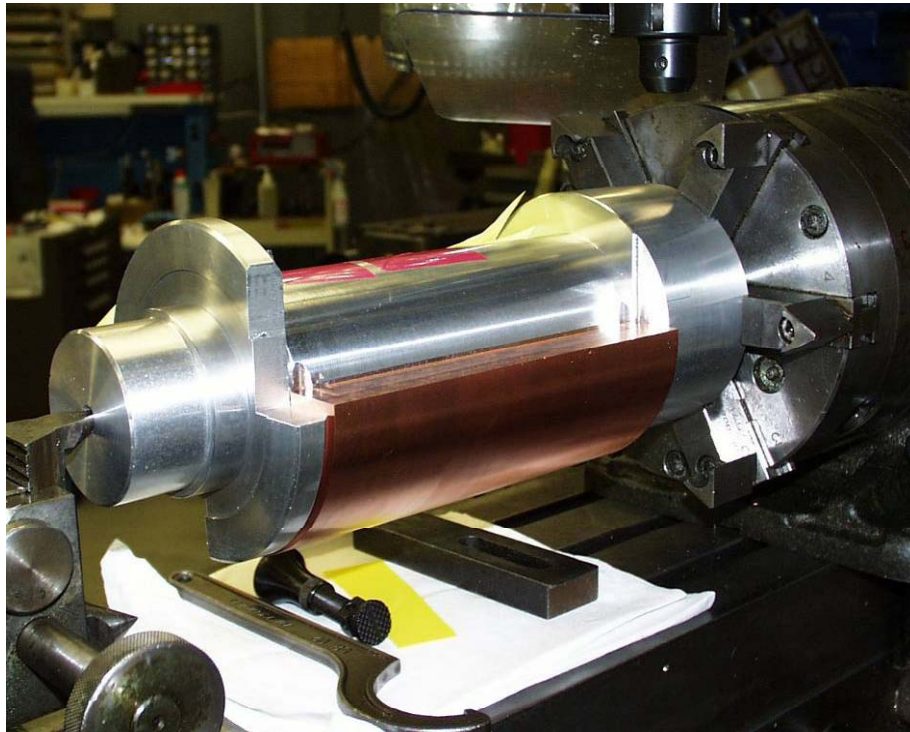
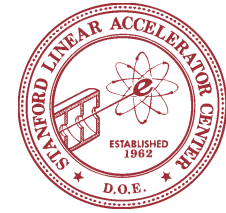

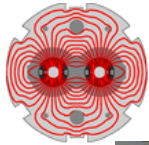

LARP

Final Wind of First 200mm Copper Mandrel

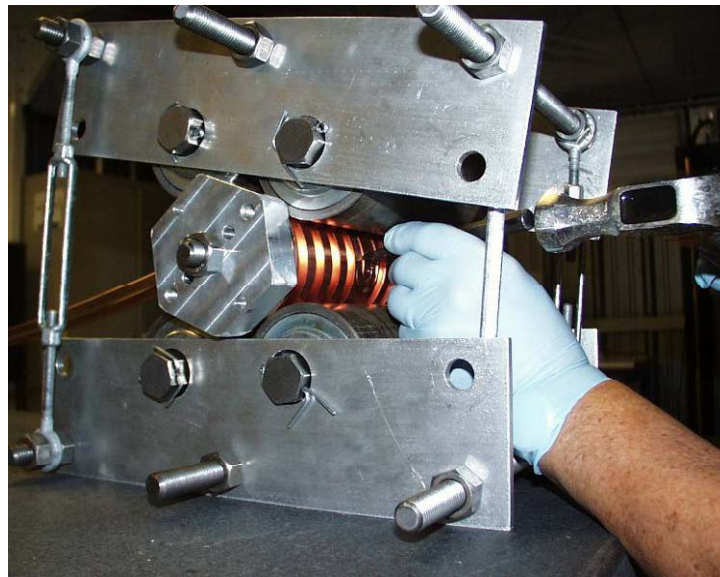
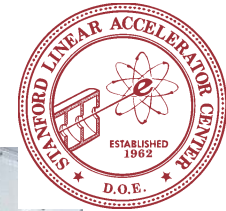

Beam'07 - 01 October 2007

Slide n° 27 / 56

LARP Phase II Collimation - T.
Markiewicz

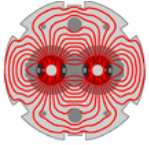

LARP

First 200mm Prototype Before-After Brazing Coil to Mandrel

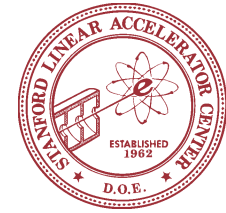

Pre-Coil-Braze

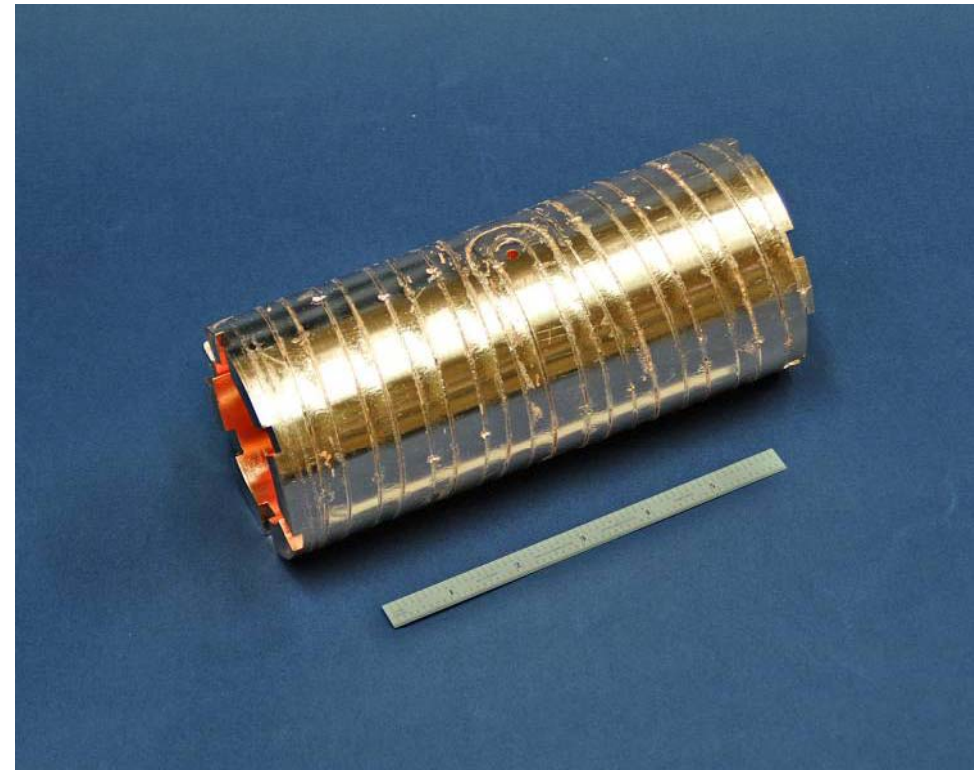

4 braze cycles were required before part deemed good enough to do jaw braze
Learned a lot about required tolerances of cooling coil and mandrel grooves

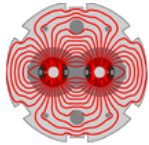

LARP

More Winding Tooling Developed

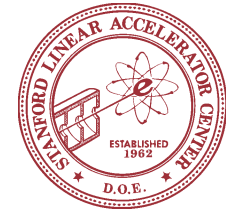

**1m winding tooling
for full length jaw**



Mill vise as precision bender

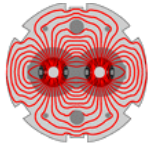

LARP

Full Length Molybdenum Shaft (final design calls for half-length Moly shaft attached to central Copper Hub so ensure good braze)

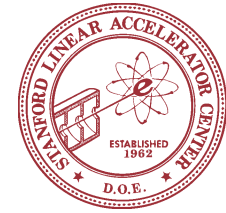

1mm raised shoulder
(Hub) at center to
produce “expansion
gap”

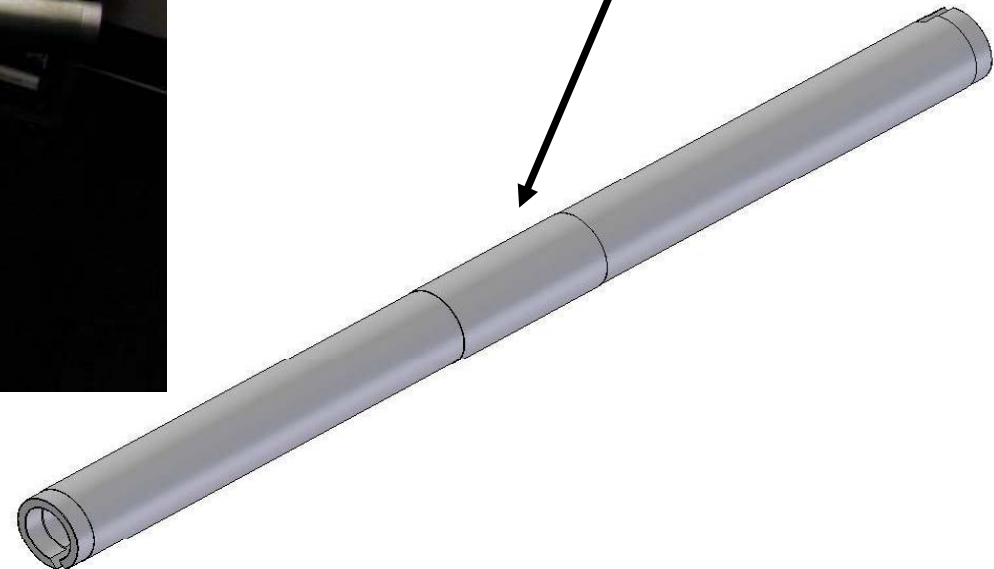

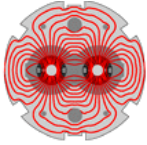

LARP

Braze Test#2 Delivered 19 Dec 2006

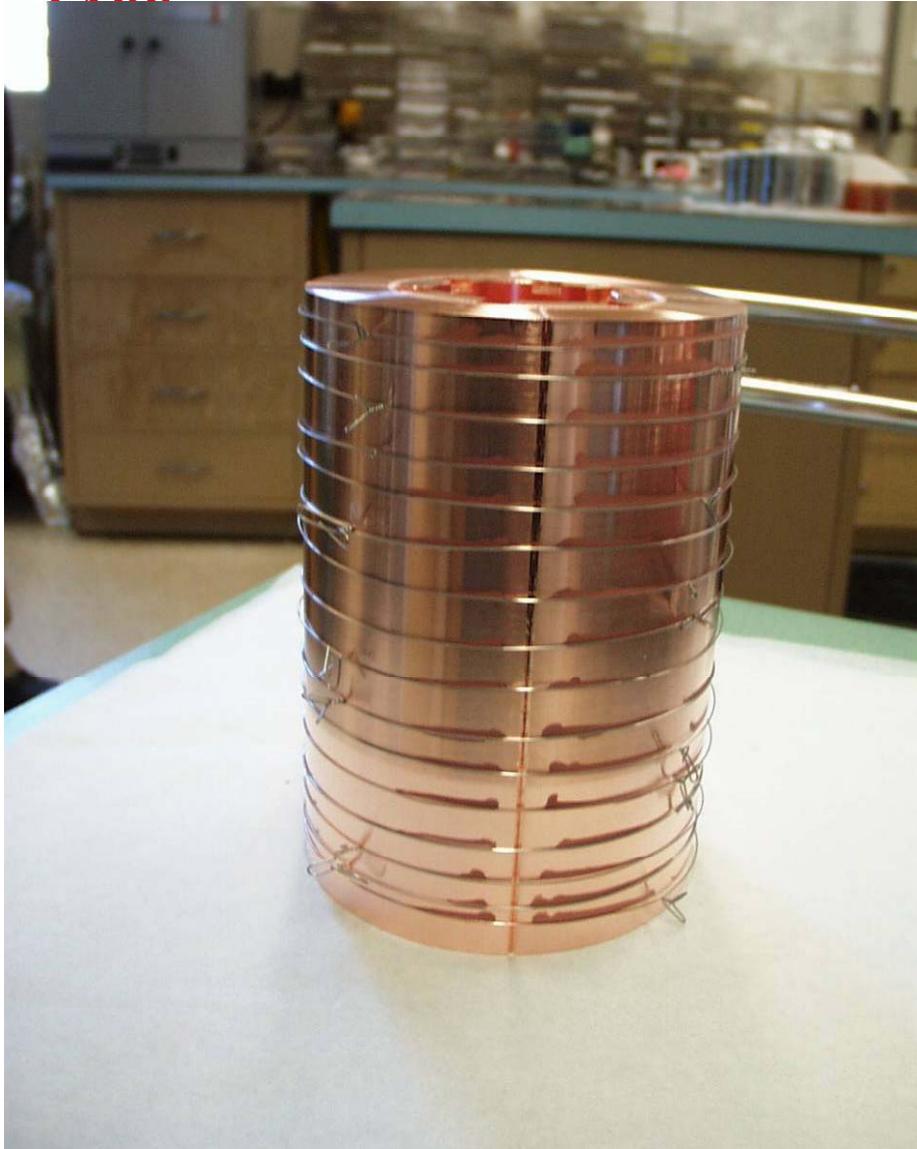
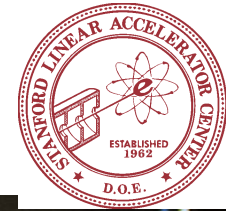

Beam'07 - 01 October 2007



Slide n° 31 / 56

LARP Phase II Collimation - T.
Markiewicz

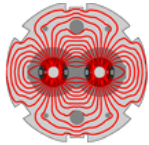

LARP

Vacuum Bake of Braze Test#2 Results: 4/1/07 ~3x over LHC Spec

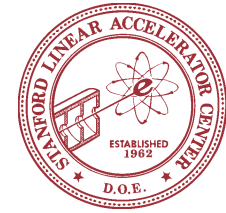

1st Jaw Braze Test Assembly has been vacuum baked at 300 degrees C for 32 hours.

- LHC Requirement = $1\text{E-}7$ Pa = $7.5\text{E-}10$ Torr
- Baseline pressure of Vacuum Test Chamber:
 $4.3\text{E-}7$ Pa ($3.2\text{E-}9$ Torr)
- Pressure w/ 200mm Jaw Assy. in Test Chamber:
 $4.9\text{E-}7$ Pa ($3.7\text{E-}9$ Torr)
- Presumed pressure of 200mm lg. Jaw Assy.:
 $6.0\text{E-}8$ Pa ($4.5\text{E-}10$ Torr)
- Note: above readings were from gauges in the foreline, closer to the pump than to the Test Chamber. Pressures at the part could be higher.

Outcome:

SLAC vacuum group has suggested **longitudinal grooves** be incorporated into the inner length of jaws; incorporated into next prototype



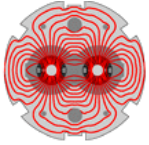

LARP

6/25/07-7/2/07 Slice & Dice Braze Test#2

Interior slice: polished & etched

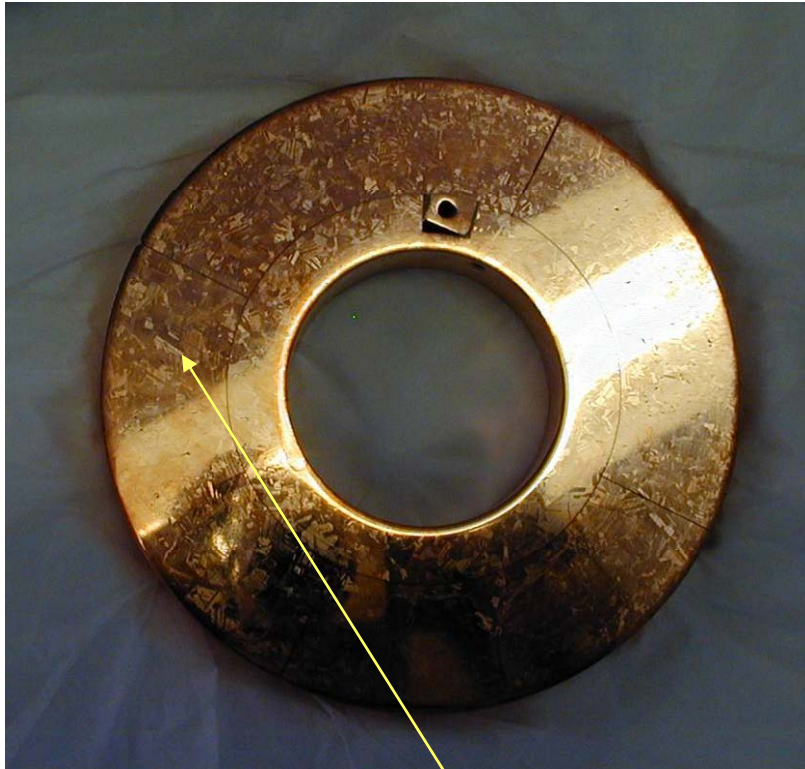

- Evidence of fracturing along grain boundaries presumed due to too-rapid cooldown after braze
 - areas near ends and OD look better
- Braze of jaws to hub GOOD
- 3 of 4 jaw-jaw brazes GOOD

Longitudinal slice

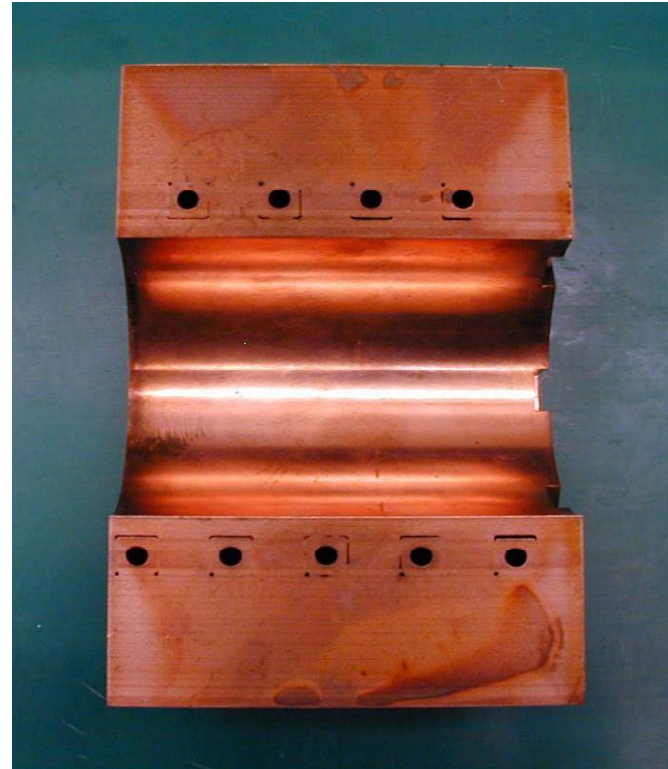

- Same fracturing patterns as in other slice
- Braze of cooling coils to jaw ID good
- Braze of cooling coil bottom to mandrel so-so

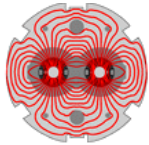

LARP

Aluminum Test Mandrel with 80mm Gap for Downstream U-Bend (11/17/06)

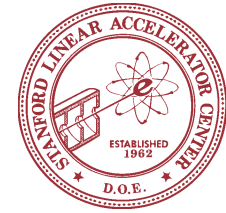

Model showing 42.5 winds of coil on Mandrel with 80mm wide space for U-Bend at downstream end

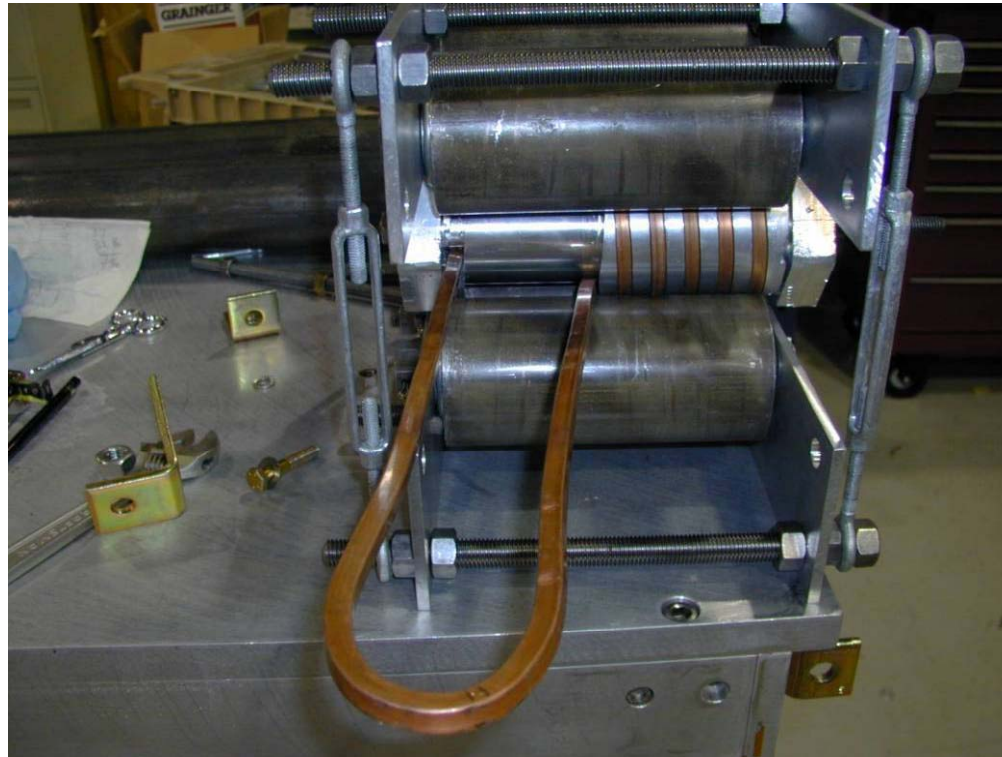
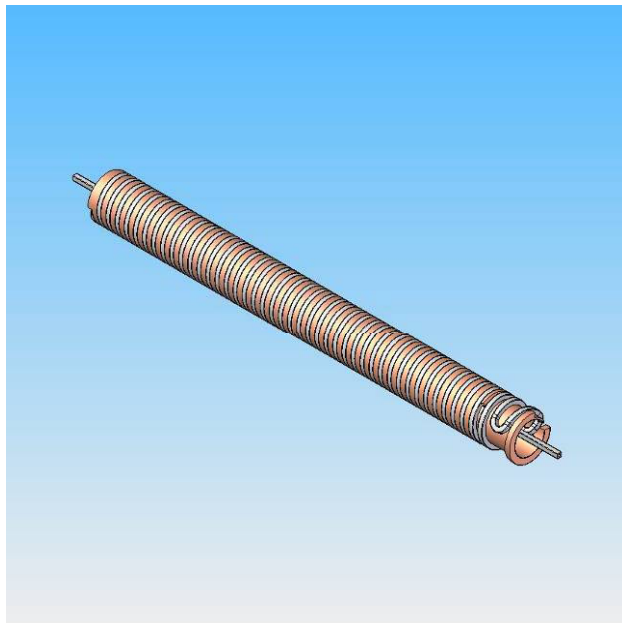

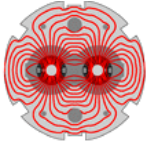

LARP

Braze Test #3: 200mm mandrel with U-Bend

Upstream end of Mandrel



Tubing Wound and Tack Welded to Mandrel at the U-Bend



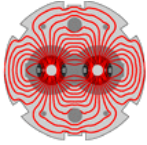

LARP

Braze Test #3: Coil-to-mandrel braze

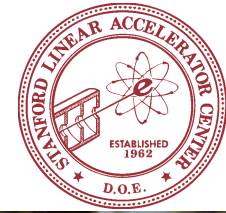

**13 Apr 07: Prepped for 1st
coil-mandrel braze**

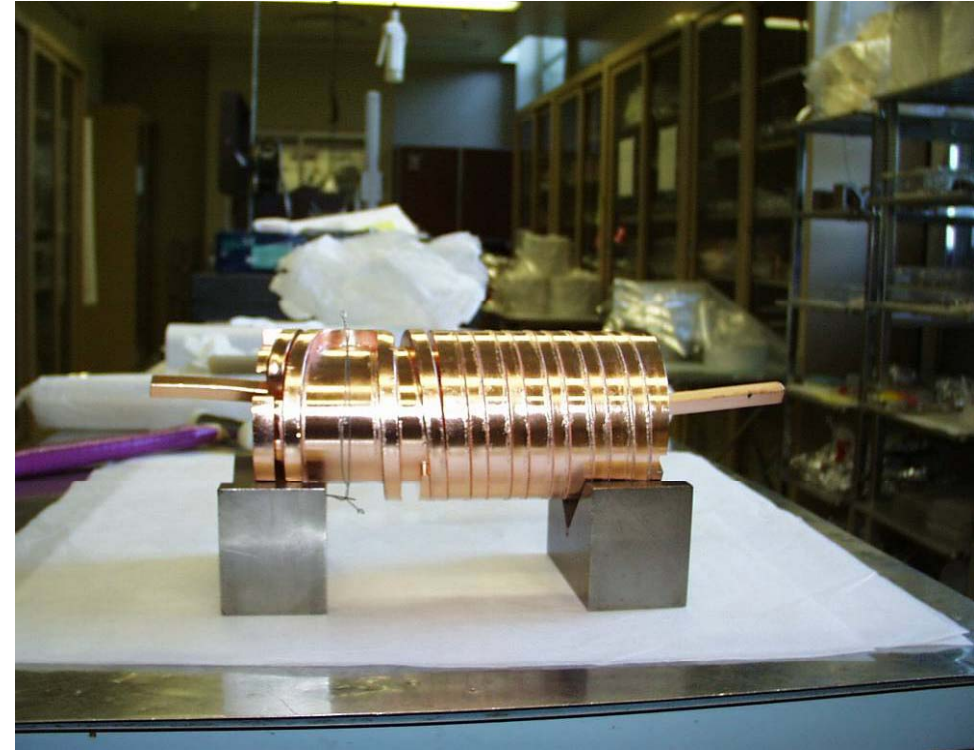

**23 Apr 07: After 2 braze cycles, OD
& braze wire grooves machined**

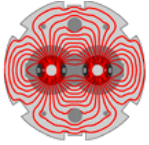

LARP

Braze Test #3: 8 1/4-round jaws to mandrel/coil

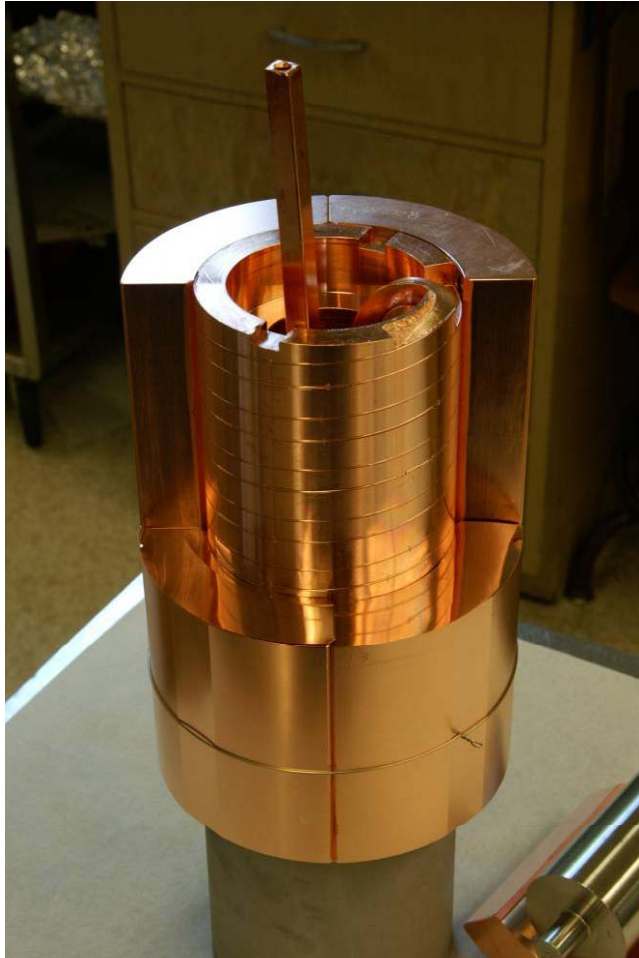
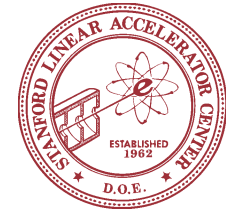

14 June 2007: Jaw Fit Up

19 June 2007: After 1st Jaw Braze
Prepped for 2nd Braze to fillup jaw-jaw joints



Next steps:

- Vacuum test (July 15)**
- Section & examine braze quality**

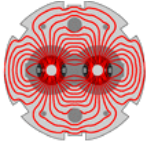

LARP

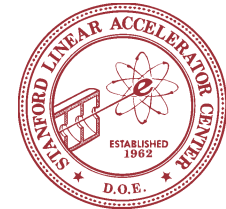

Braze Test #3: Vacuum tests

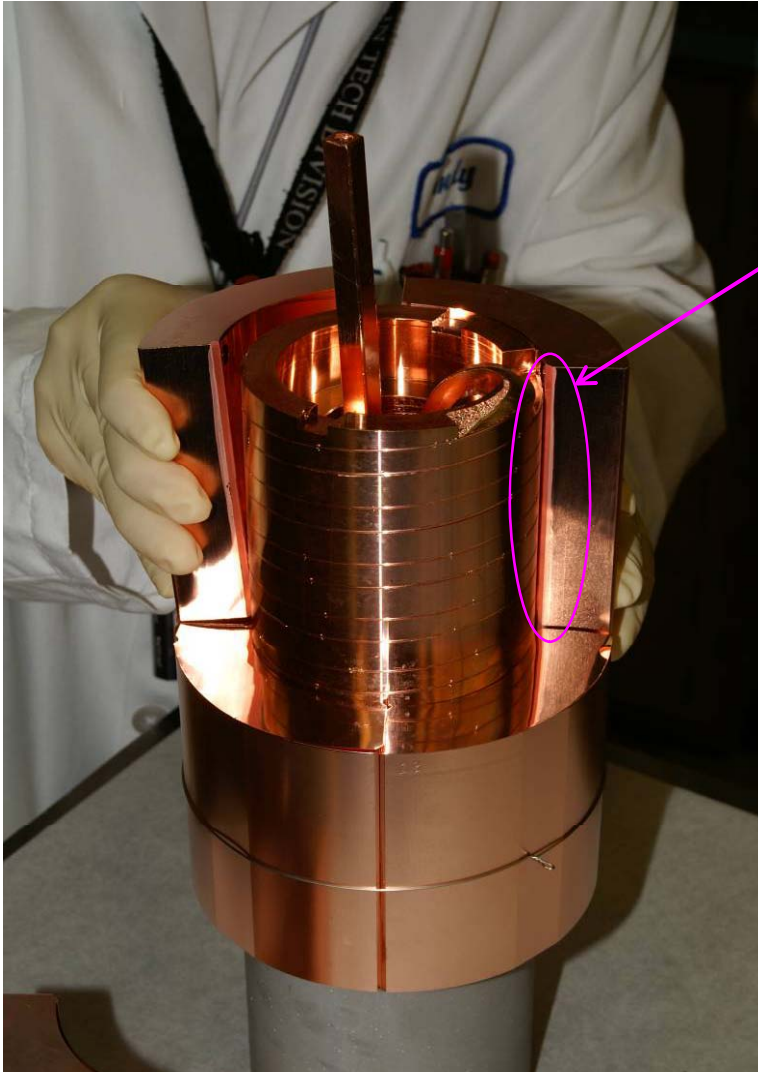

- 3rd Jaw Braze Test Assembly has been vacuum baked at 300 degrees C for 32 hours. Results in slightly lower pressure.
- Inclusion of longitudinal grooves in the inner length of jaws for better outgasing
- Test Chamber setup similar to previous test.

	Old	New
Baseline	3.2E-9 Torr	2.4E-9 Torr??
w/ jaw assy.	3.7E-9 Torr	3.4E-9 Torr
Presumed jaw assy. pressure	4.5E-10 Torr	10E-10 Torr??
LHC requirement	7.5E-10 Torr	7.5E-10 Torr

Under Investigation...

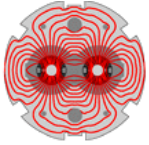

LARP

Braze Test #3: Sectioning & Examination

Cu grain boundary cracking during brazing

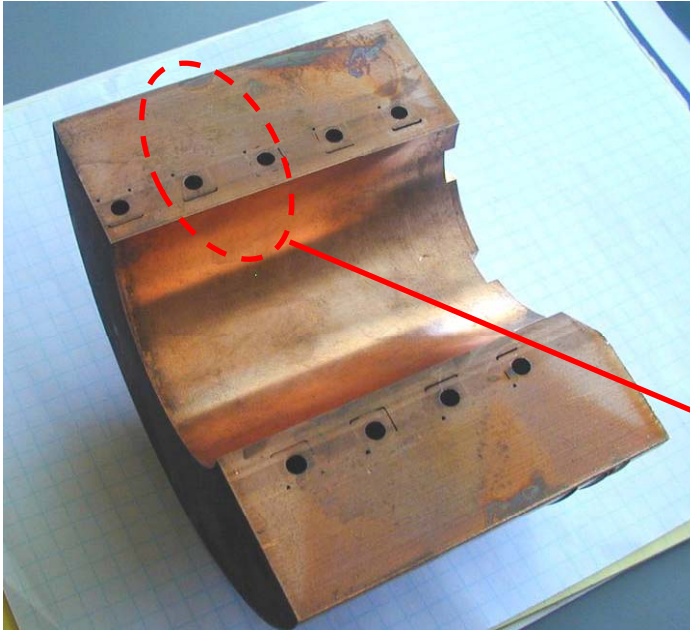

Specimen 140mm OD x 60mm ID x 200mm L (¼ section shown)

- one braze cycle in the 900 C range
- grain boundary cracks located in interior regions
- believed due to excessive heating rate
- **Glidcop to be tested**

Concerns

- Effect on performance
- What happens in accident case?

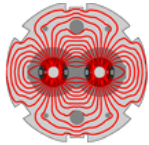

LARP

Glidcop Al-15 Heat sample

While 1st jaw used to test thermal mechanical issues is Copper, first full 2 jaw prototype will use Glidcop

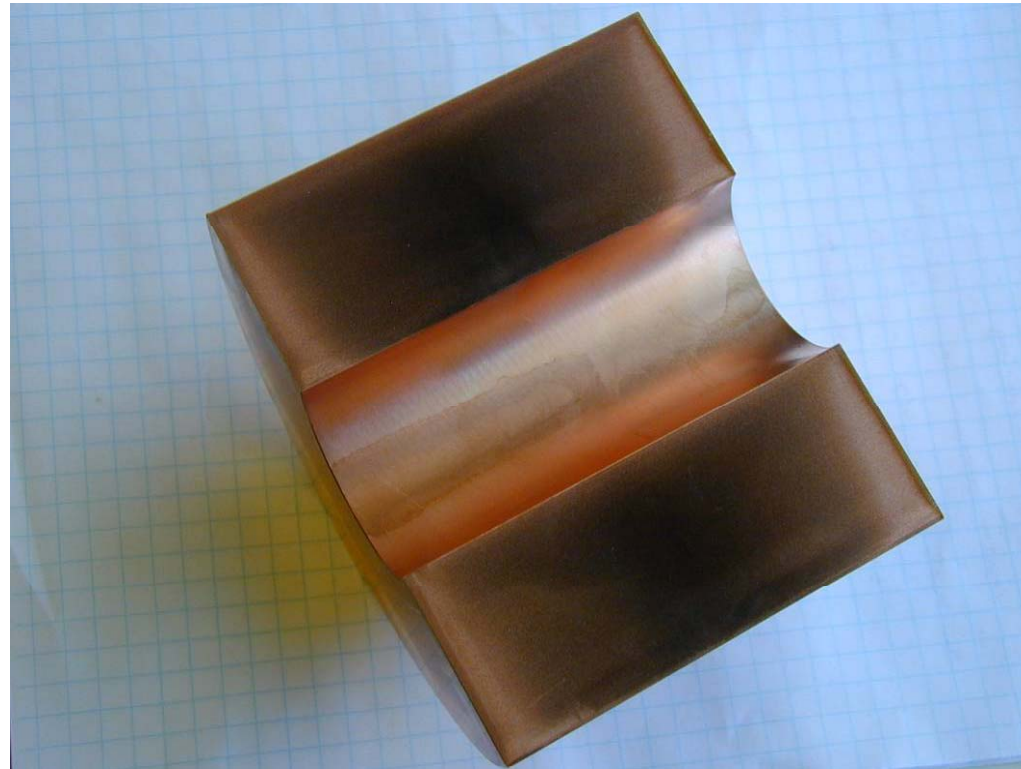
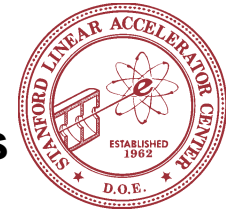

2 Heats (at Jaw brazing temperature)

No grain boundary cracking is apparent

Metallographic samples are being prepared for microscopic inspection

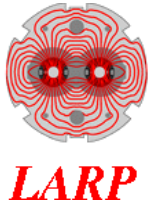

Fear of Copper-Moly Shaft-to-Mandrel Braze Joint Leads to Mini R&D Cycle Devoted to Issue

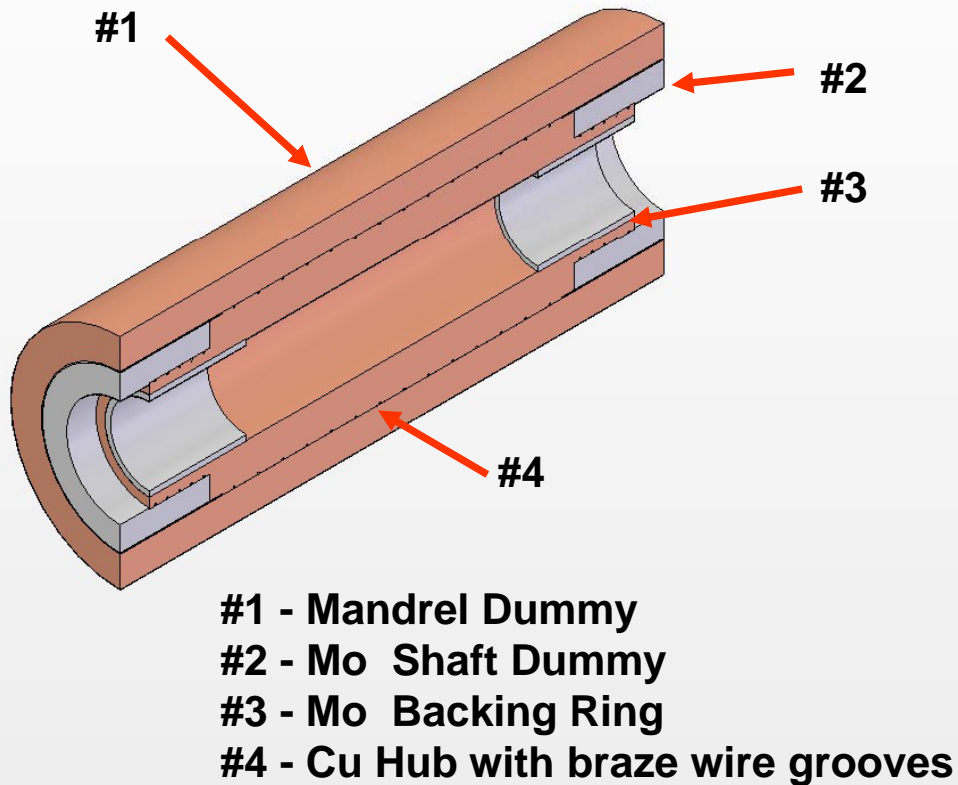
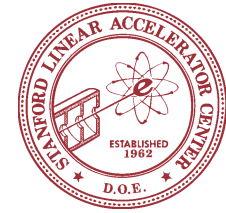

Initial plan to braze one long Mo shaft with raised hub to inner radius of Cu mandrel deemed unworkable

Brazing HALF-LENGTH shafts to a COPPER hub piece and THEN brazing the Cu hub to the Cu mandrel deemed possible

First test if Mo “backing ring” sufficient to keep Mo and Cu in good enough contact for a strong braze joint

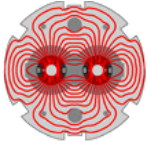

LARP

Cu-Mo Hub Braze Test parts

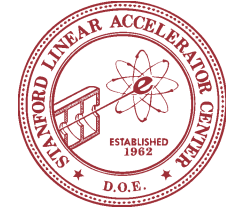

28 Feb 2007: Cu-Mo Braze Test Parts

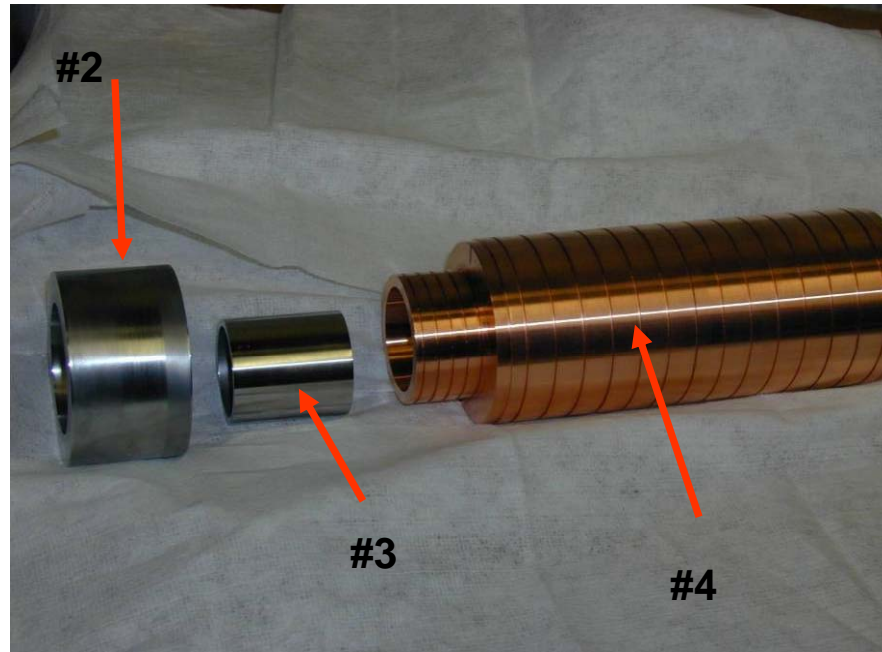

- #1 - Mandrel Dummy (not shown)
- #2 - Mo Shaft Dummy
- #3 - Mo Backing Ring
- #4 - Cu Hub with braze wire grooves

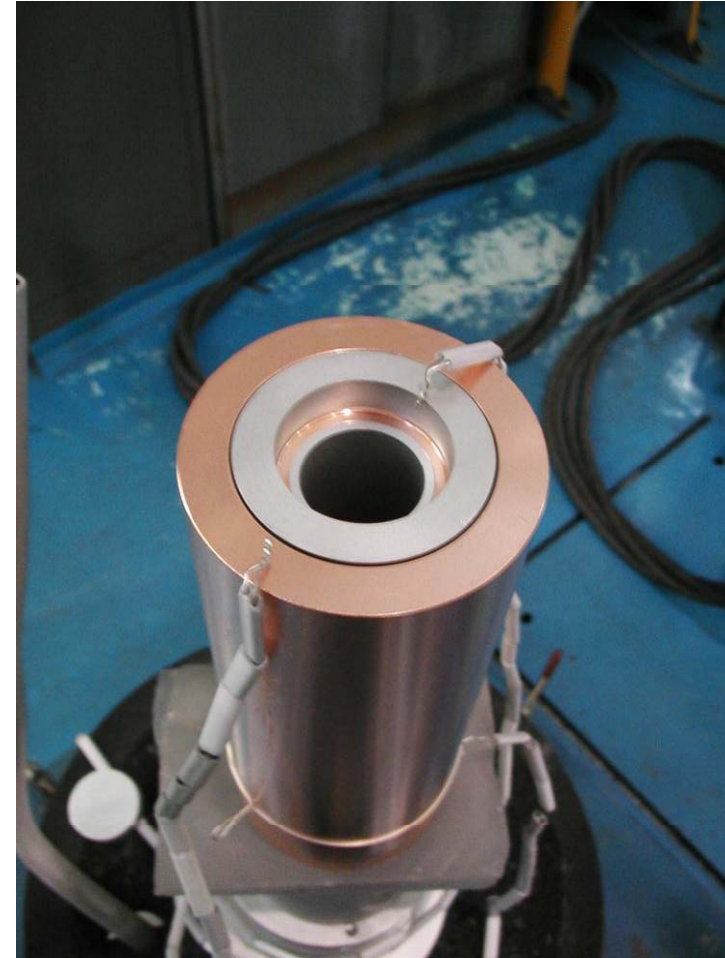

27 Mar 2007: Cu-Mo Braze In Oven

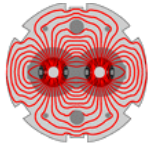

LARP

Apr 6: Cu-Mo Hub Braze Test Assembly after 3 additional heat cycles (to mimic full assembly procedure) then sectioned. Cu "finger" fractured

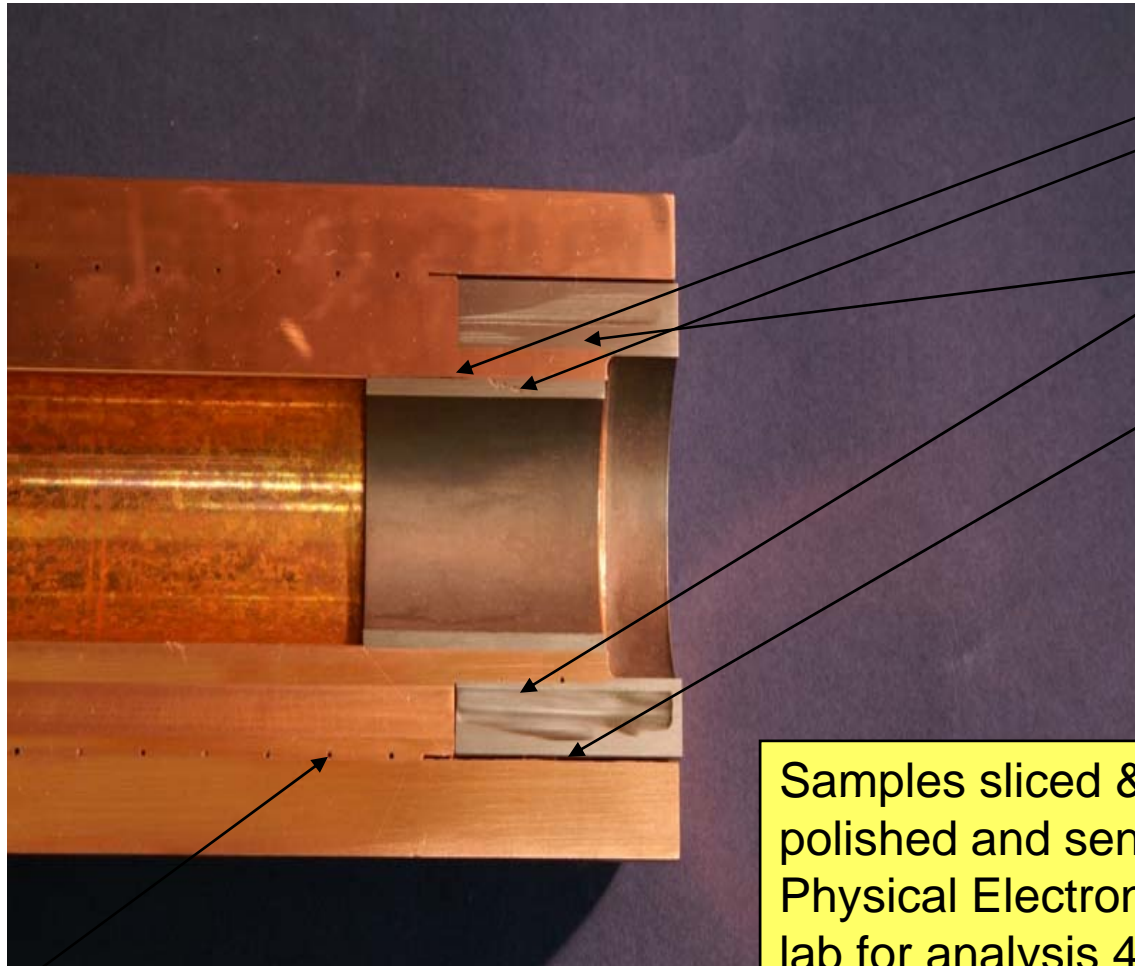
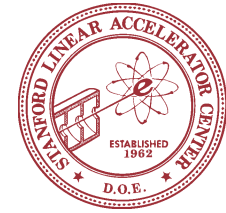

- Grain boundary issues?
- Possible fracturing?

Cu-Mo joints we care about

1mm expansion gap

Small holes held braze wire

Samples sliced & polished and sent to Physical Electronics lab for analysis 4/23:
Fractures evident

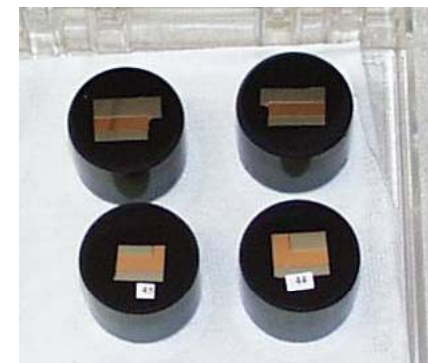

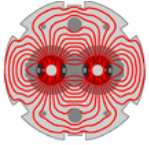

LARP

Compression fit for Cu-Mo joint

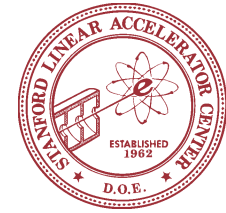

- Another option is to use a compression fit and diffusion bonding.

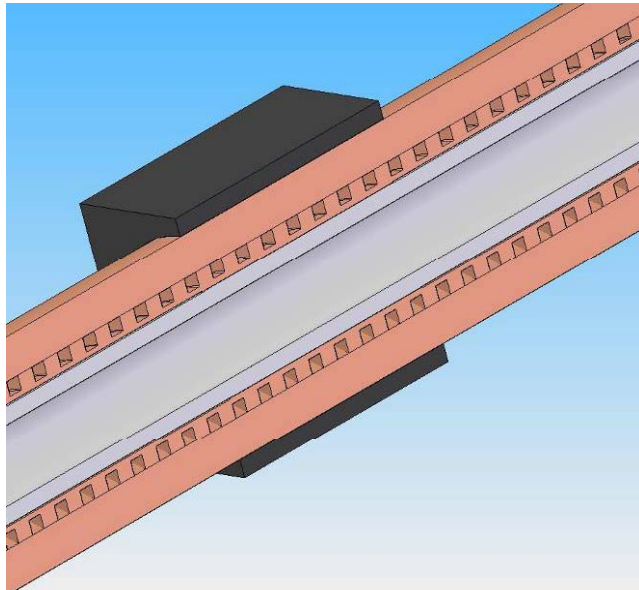

Copper Jaw is constrained on the outside diameter with Carbon and when heated to ~ 900 degrees C is forced to yield so that upon cooling to ~ 500 degrees C the inner diameter begins to shrink onto the Mo Shaft resulting a substantial interference fit.

Test hub fell apart once we made a slice!

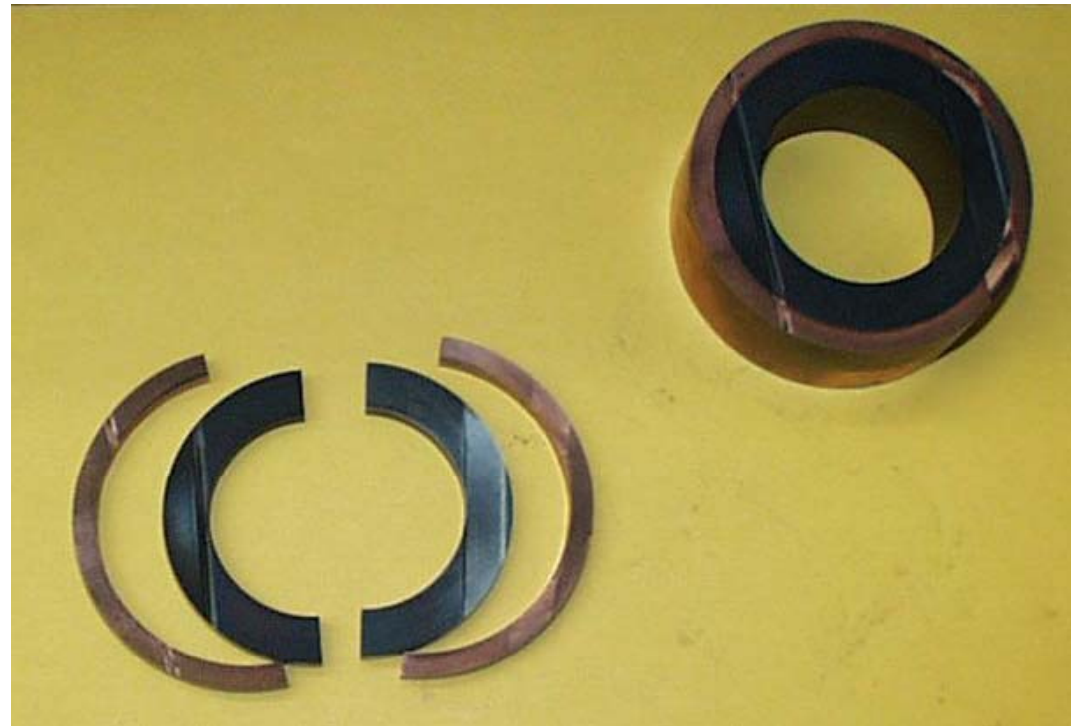

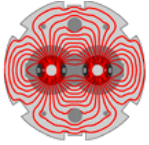

LARP

Cu-Mo joint: Segmented Moly for expansion

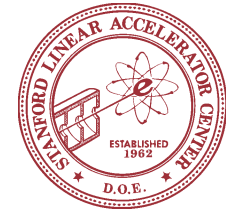

- Another option is to use a segmented flexible molybdenum end to prevent fractures and prevent Co from pulling away from Moly.

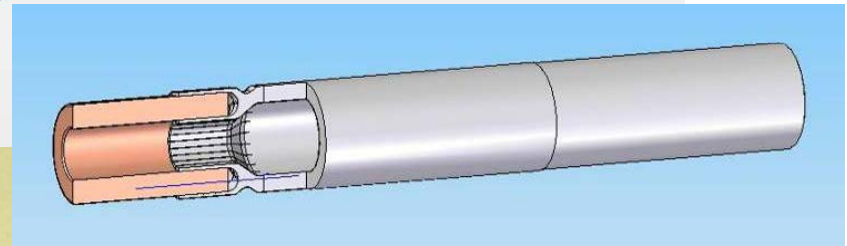
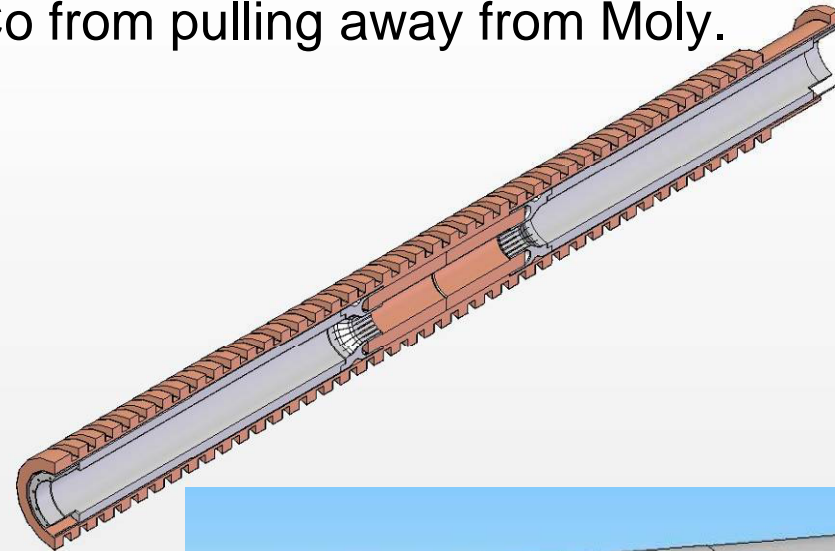
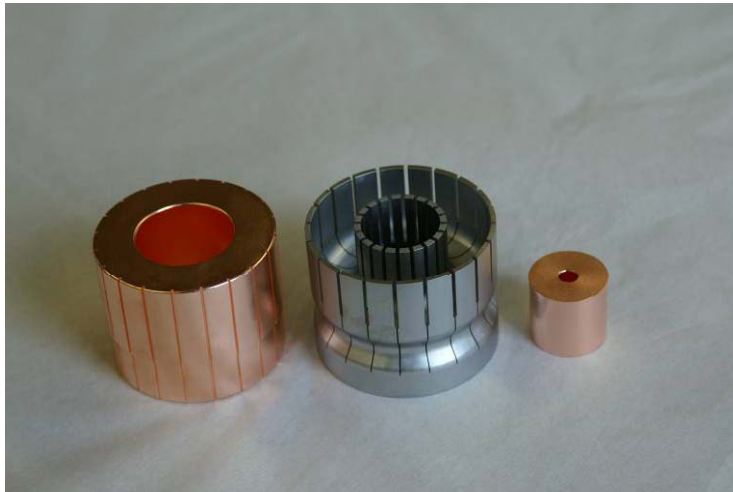

Will be cutting small samples for metallurgy tests. May make slight modifications for better braze joint

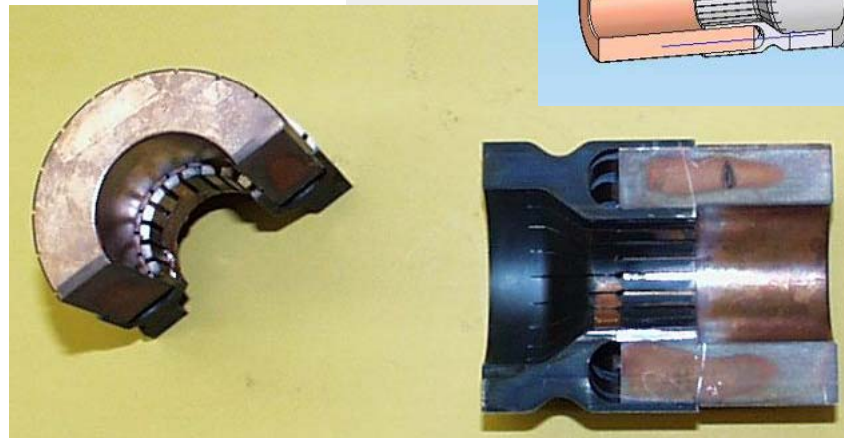



Molybdenum Half Shafts & Copper Hub Halves braze preparations

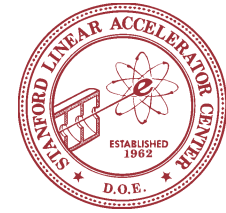

Expander Plug

Retainer Ring

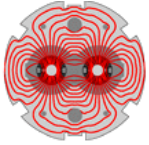

21 Mar 2007: Full length Mandrel: In-House & Inspected

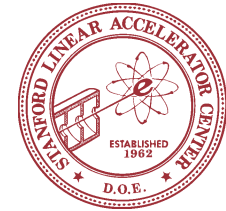

LARP

- Now that shaft design complete, order to bore central hole made
- Will wind with in-house copper tubing

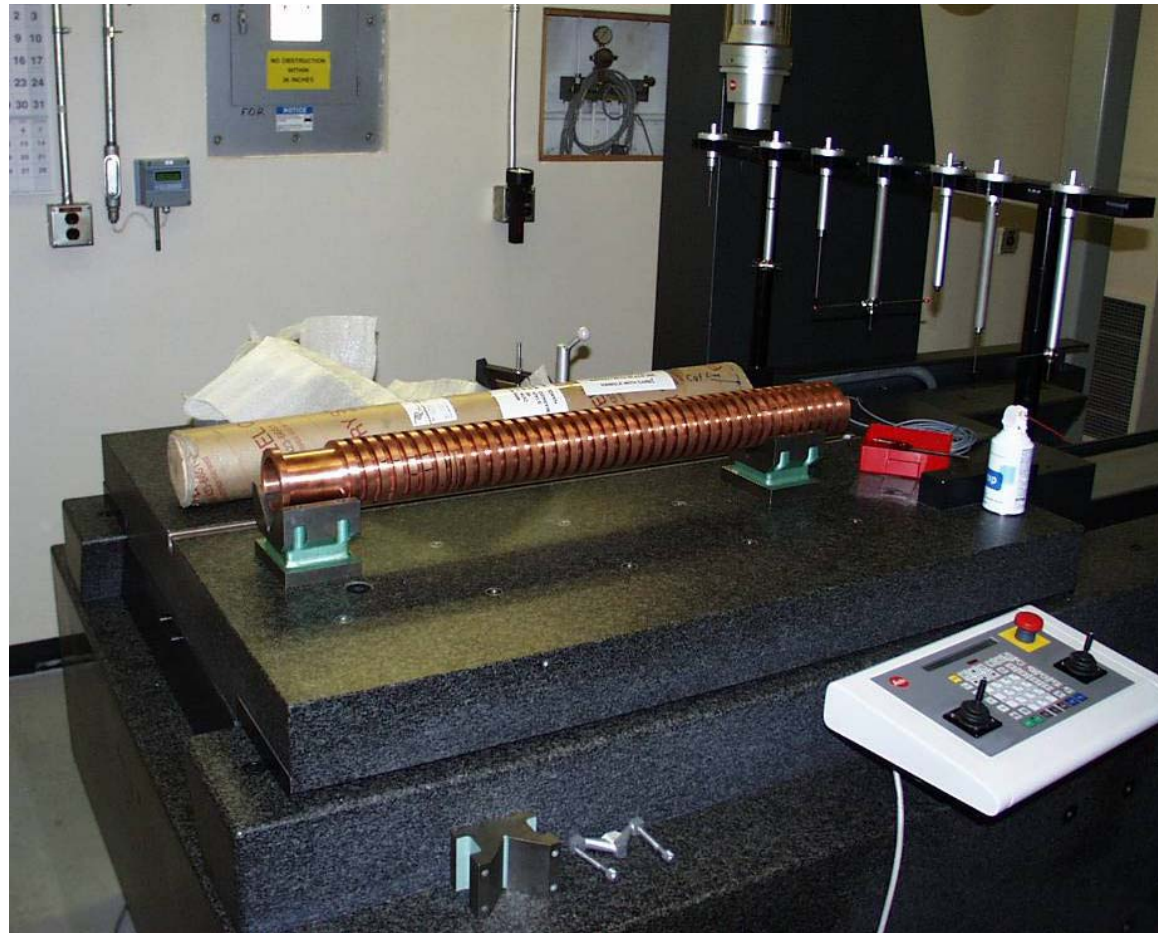



Fixture for stacking 16 24cm-long quarter round jaws on full 960mm cooling coil wrapped mandrel (mostly catalog parts: ordered)

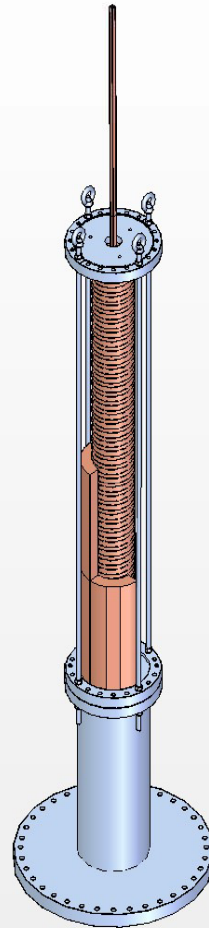
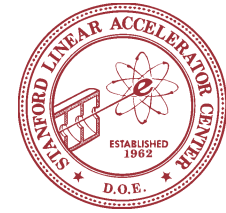



Exploded view of CAD model of Flex Mount

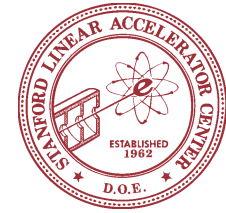

**Triple Cog
Geneva Drive
Wheel required
for 512 clicks per
facet**

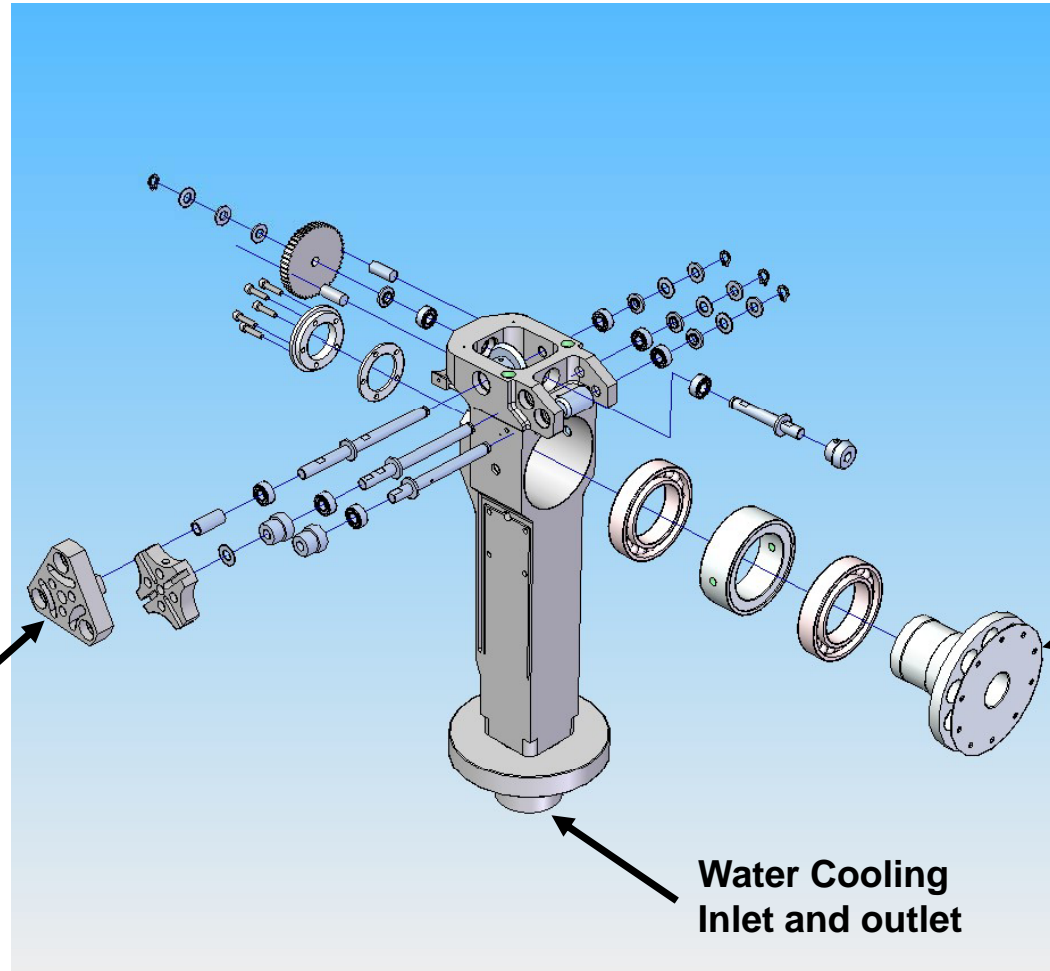

**U-Joint Flexes for
Shaft "sag" and
"Slewing"**

**Water Cooling
Inlet and outlet**

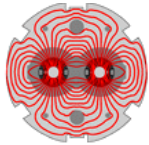

LARP

Up Beam Flex Mount Assembly showing Ratchet and Actuator

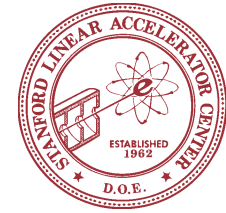

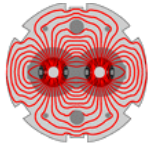

LARP

Test Lab Preparation ~Finished

- ✓ Clean space with gantry access
- ✓ Basic equipment: Granite table, racks, hand tools
- ✓ Power supplies to drive heaters
- ✓ Chiller & plumbed LCW to cool jaw
- ✓ 480V wiring for heater power supplies
 - required engineering review, safety review, and multiple bids (?!)
- ✓ Acquire Heaters
 - 5kW resistive heaters from OMEGA
- ✓ PC & Labview
 - ✓ Rudimentary software tests only
- ✓ National Instruments DAQ with ADCs
 - Data Acquisition and Control Module
 - 32-Channel Isothermal Terminal Block
 - 32-Channel Amplifier
- ✓ Thermocouples
- ✓ Capacitive Sensors
- Vacuum or Nitrogen (?)
- Safety Authorization (!!!)

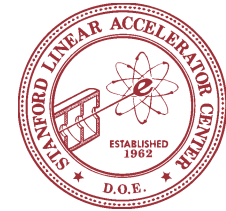

Adjacent 16.5 kW Chiller



Heater Power Supplies staged for installation in rack



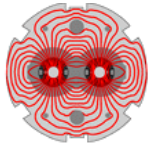

LARP

Steps still needed for a full length jaw assembly for thermal testing

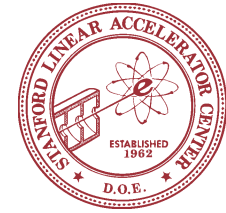

- ✓ After 200mm Jaw tests Completed Satisfactorily Freeze brazing protocol
- Drill Cu mandrel for Moly Shaft (out at vendor)
- ✓ Cut Moly shaft into two pieces, fab parts for hub assembly
- Braze shaft to bored out mandrel
- Wind coil using in-house SLAC Copper,
 - Need to order more (Finland 20 week delivery) OFE 10mm x 10mm or use CERN order of Ni-Cu alloy, anneal & wind mandrel
- Jaw 1/4 sections (16 needed of 24 now at SLAC) require slight modifications for braze gap requirements.
- Several braze Cycles
- Drill jaw to accept resistive heater or attach with thermal grease
 - Understand (ANSYS) any change to expected performance

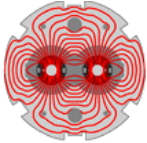

Steps needed for a complete mechanical (=“RC1”) prototype

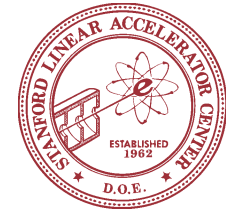

LARP

- Successful thermal performance of first full length jaw
- Complete the design of RC1 RF features
- Fit-up and initial tests of support/rotation mechanism on 1st full length jaw
- Complete fabrication of second and third jaws (Glidcop, Moly?) with full support assembly on the four corners
- Acquisition of Phase I support & mover assemblies
 - 18 APR 07 proposal to sell SLAC a non-functional CERN TCS collimator with damaged tank & bellows
- Remodeling of CERN parts for interface to US parts
 - An enlarged vacuum tank has been modeled and some CERN support stand modifications have been identified
 - No fabrication drawings have been done as yet
- Acquire motors, LDVTs, etc.. Not part of CERN TCS purchase

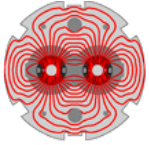

LARP

Agreement in Progress to Buy a damaged “TCS1” collimator and stand from CERN

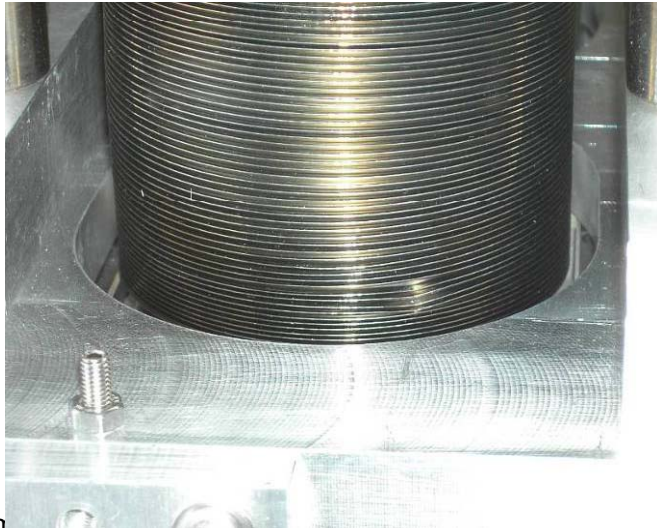

Beam pipe collimator assembly

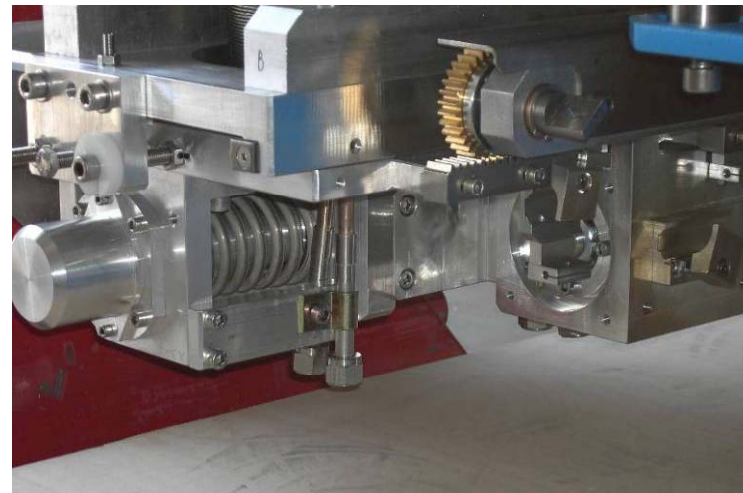

Slide n° 54 / 56

LARP Phase II Collimation - T.
Markiewicz

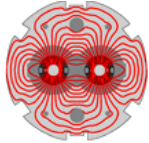

LARP

LARP Collimator Delivery Schedule

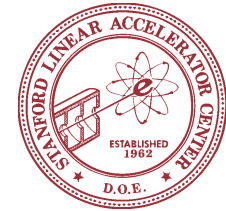

Done	Braze test #1 (short piece) & coil winding procedures/hardware Prep heaters, chillers, measurement sensors & fixtures, DAQ & lab Section Braze test #2 (200mm Cu) and examine –apply lessons Braze test #3 (200mm Cu) – apply lessons learned
	Fab/braze 930mm shaft, mandrel, coil & jaw pieces
2008-01-01	1 st full length jaw ready for thermal tests
	Fab 4 shaft supports with bearings & rotation mechanism Fab 2 nd 930mm jaw as above with final materials (Glidcop) and equip with rf features, cooling features, motors, etc. Modify 1 st jaw or fab a 3 rd jaw identical to 2 nd jaw, as above Mount 2 jaws in vacuum vessel with external alignment features
2008-09-01	2 full length jaws with full motion control in vacuum tank available for mechanical & vacuum tests in all orientations (“RC1”)
	Modify RC1 as required to meet requirements
2009-01-01	Final prototype (“RC2”) fully operational with final materials, LHC control system-compatible, prototype shipped to CERN to beam test

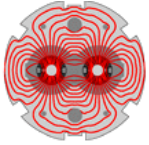

LARP

Conclusions

In a limited time with a relatively few people LARP team has

- Finalized a workable design (modulo rf design) and produced most full length mechanical fabrication drawings and models
- Finished all pretests, tooling and examinations that also required many fabrication drawing
- Is on track (?) to deliver full length operational prototypes on time
- Expected performance
 - 230 um flatness under 60kW/jaw/10 sec 12 minute beam lifetime
- Major uncertainties left have to due with 1 MJ “accident” case
 - Beam test
 - Advanced calculations (cf: Sept 2007 Collimator Materials Workshop)

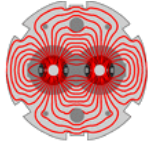

LARP

Bonus Slides

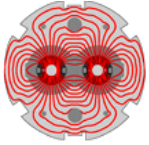

BNL Irradiation (BLIP) and Post-Irradiation Testing Facilities and Set-Up



LARP Layout of multi-material irradiation matrix at BNL BLIP

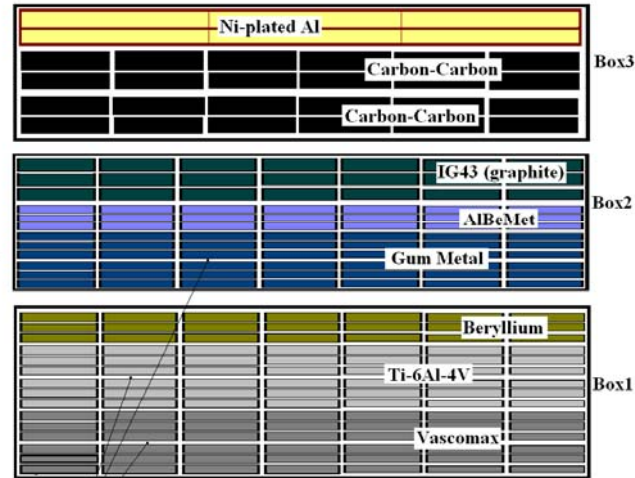

Cooling Water Channels
200 MeV (~ 70 μA)

Test Specimen Assembly

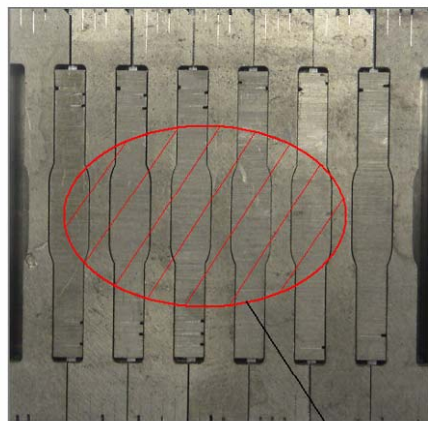

Proton Beam Footprint



Dilatometer Set-up In Hot Cell #1

Remotely-operated tensile testing system in Hot Cell #2



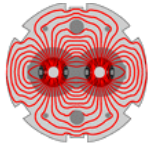

LARP

CTE Measurements of Irradiated Copper

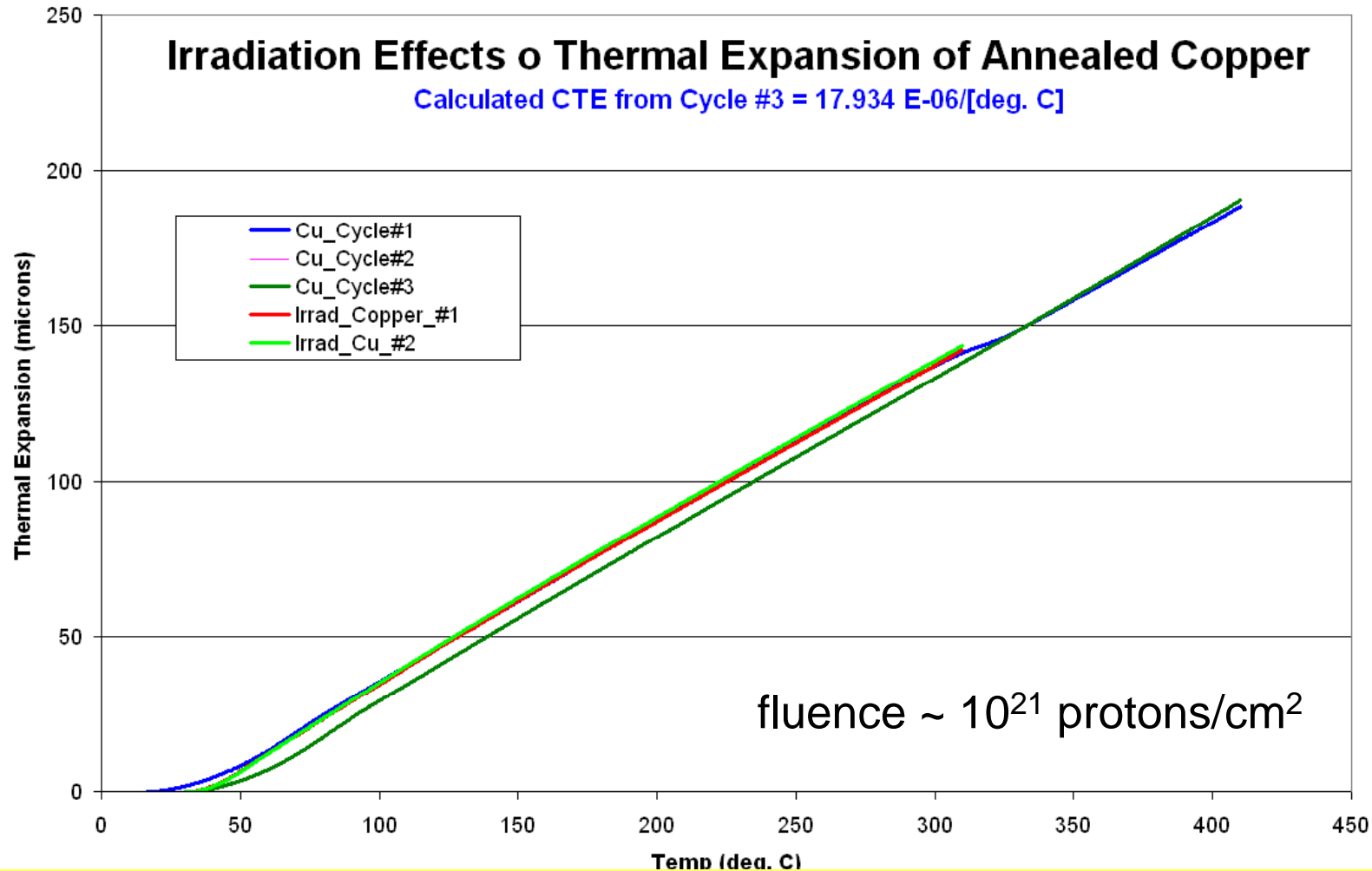

To Do: Measurements of Thermal Conductivity & Mechanical Properties

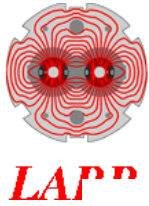

CTE Measurements of Irradiated GlidCop



IRRADIATION EFFECTS ON GLIDCOP

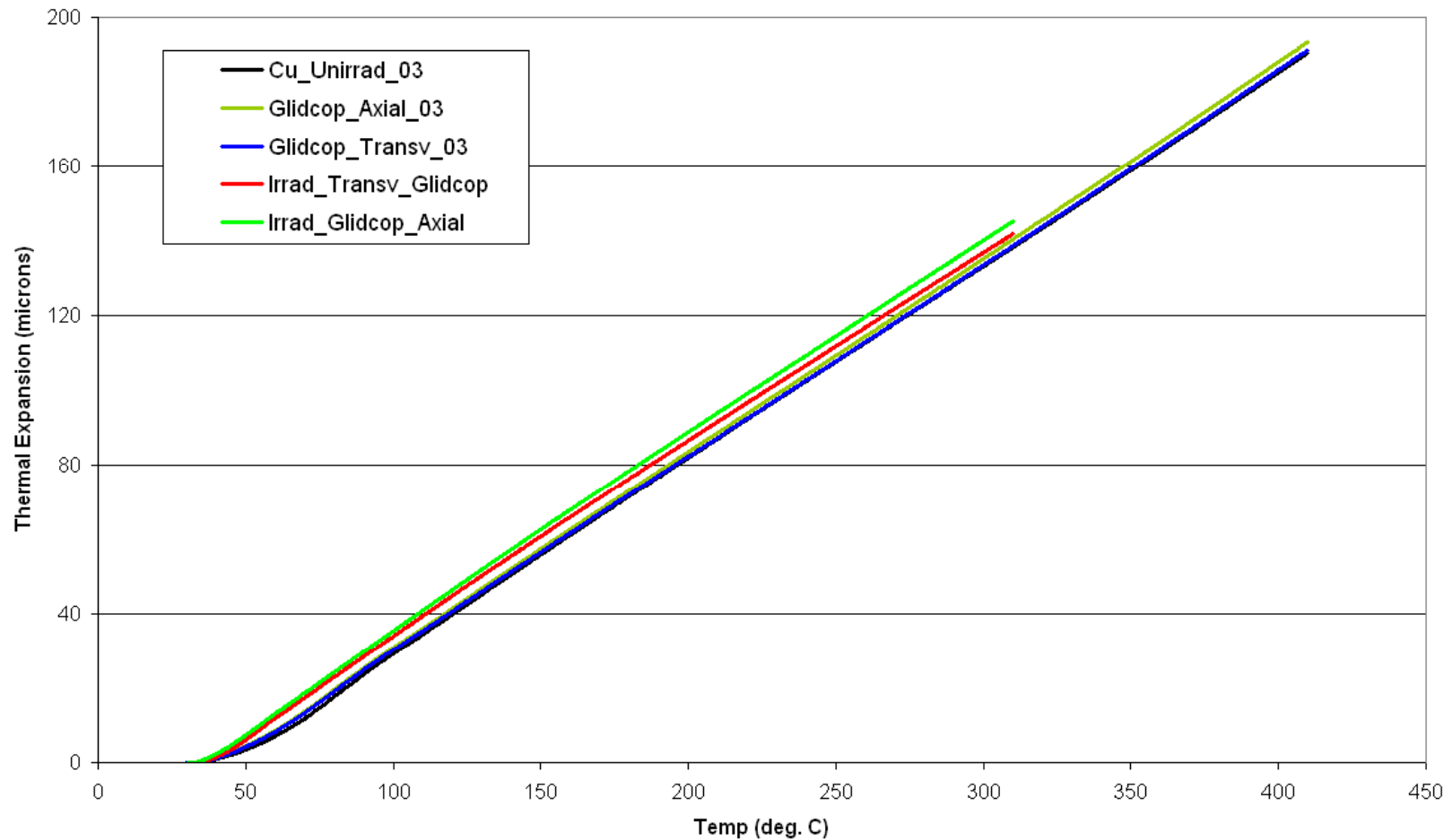

fluence $\sim 10^{21}$ protons/cm²

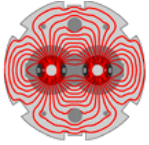

Rotatable Collimator Activation & Handling

LARP

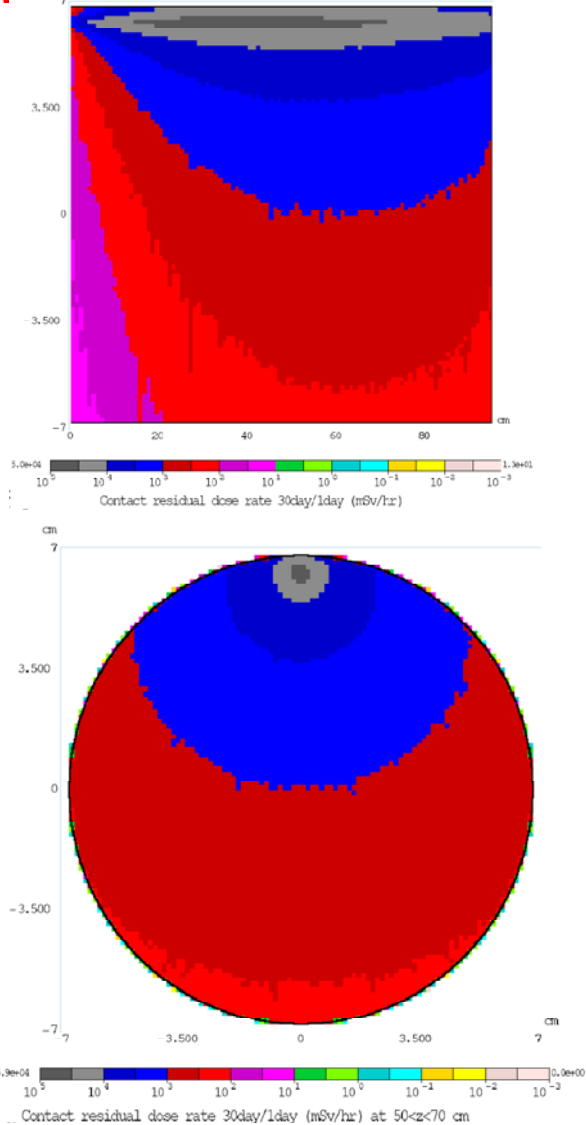

Residual dose averaged over collimator copper jaws

$\langle I \rangle = 4. \text{e}9 \text{ p/s at } 7 \text{ TeV}$

MARS15

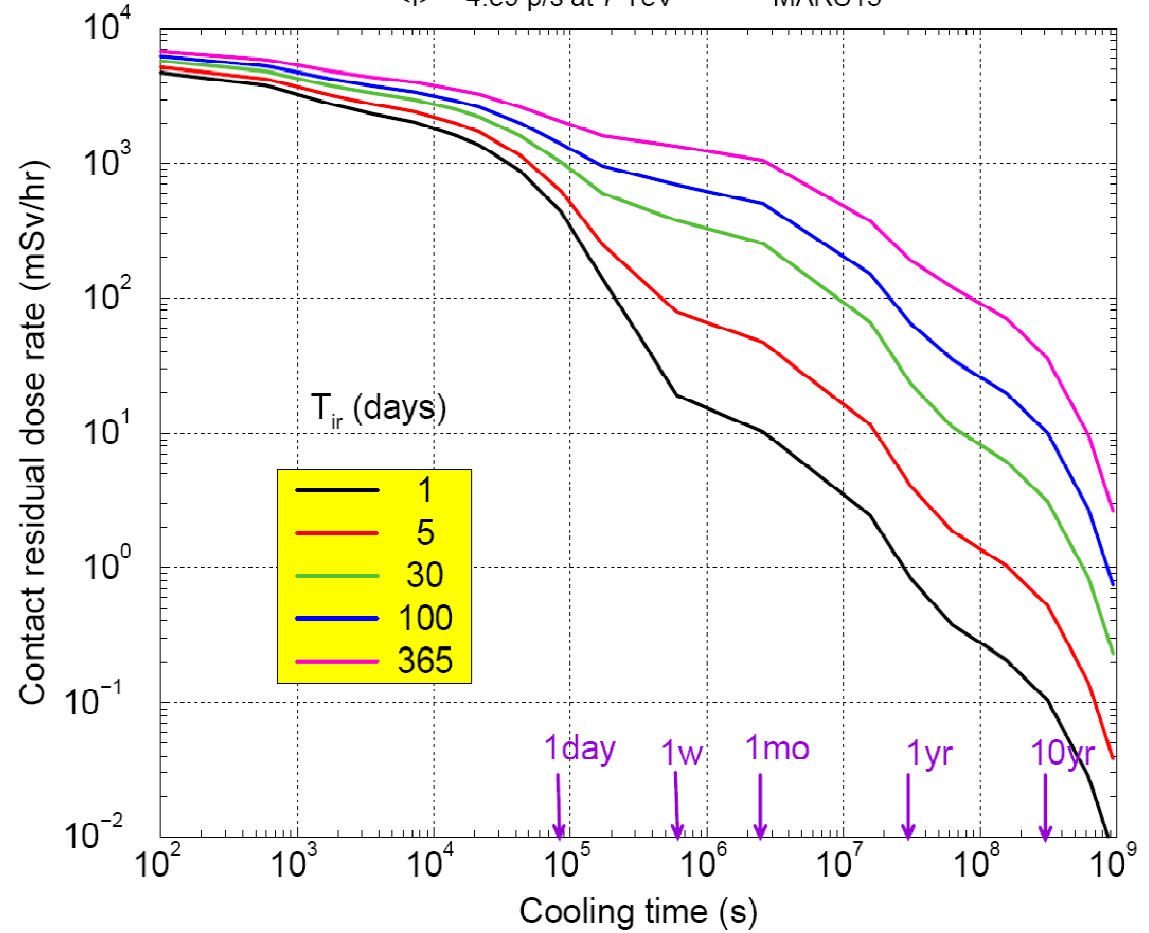

Need dose rate at ~1m; Mokhov et al

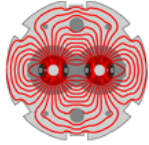

LARP

Inter-Lab Collaboration

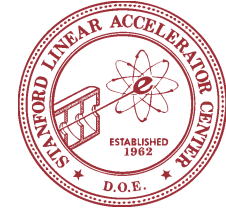

Good will & cooperation limited only by busy work loads

- Regular ~monthly video meetings
- Many technical exchanges via email
- CERN FLUKA team modeling Rotatable Collimator
- CERN Engineering team looking at SLAC solid-model of RC and independently doing ANSYS calculations of thermal shock
- CERN physicists
 - investigating effects of Cu jaws at various settings on collimation efficiency
 - Participating in discussion of RF shielding design
- SLAC Participation in upcoming CERN Phase II brainstorming meeting

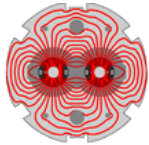

LARP

Examples of CERN Collaboration on SLAC Phase II Design

Phase II – TCSM fluka model

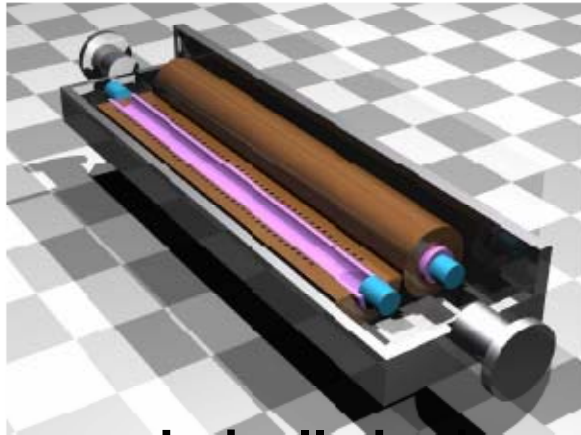

3/8/2007

Luisella Lari

Lari - AB/AT/EEET
LARP Collimator Video Meeting

4 questions to answer (3/3)

In conclusion

- ⇒ SIMULATIONS should be performed for the slots etc... (geometric part)
- ⇒ MEASUREMENTS should be performed for the contact resistance

Elias Metral Addressing RF Concerns



The LHC Collimation project



LHC Collimators - Phase II

Accident case – simplified elastic-plastic analysis of SLAC Rotatable Jaw

*Alessandro Bertarelli
Alessandro Dallochio
Pawel Smas*

*Monthly LARP Collimator Video Meeting
2007-03-07*

Collaboration on ANSYS

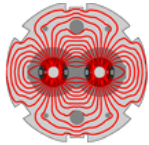

LARP

Collaboration on Tracking Efficiency Studies

Chiara Bracco - CERN



Global inefficiency as function of TCS jaws' length

For jaws longer than 50 cm the global inefficiency is constant

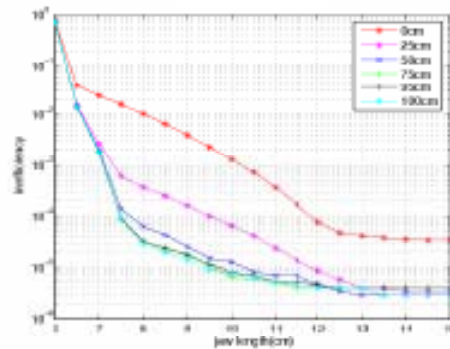

Low beta skew halo beam 1

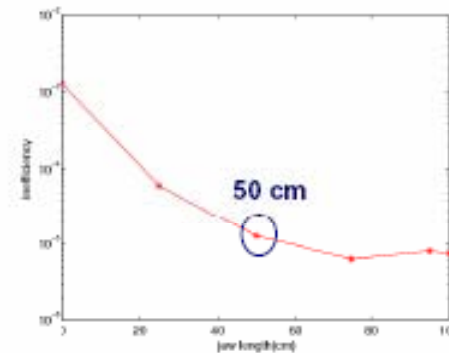

12/11/2006

Chiara Bracco

5

- Phase II collimators should provide x 2.5 improvement in global inefficiency
- Beam intensity limitations are due to losses in the dispersion suppressor above the quench limit. These losses are not improved by metallic secondary collimators
- Solutions must be found to improve performance of primary collimators

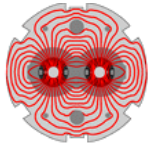

LARP

Specification Changes Relative to April 2006 Design

		RC1 Report 12/12/05	Current
	spec	value	value
jaw	Length	95cm including 10cm end tapers	93cm with 1cm end tapers
	Diameter	136mm	20 facets, tangent to ϕ 136mm
	Material	Copper	Glidcop AL-15
	cooling	Embedded helical channel	Reduced helix depth, Helix pitch reversal
	Special features	Circumferential slots to reduce thermal-induced bending, if no RF problems	eliminated
	deformation	<25um toward beam; <325mm away in steady state; <750um away in 10 sec transient	Inward: 84um SS, 236um Trans – 1 st coll to be set at 8.5 σ for clearance
	Range of motion	25mm per jaw, including +/- 5mm beam location drift	27.5 mm per jaw including +/- 5mm
Aperture stop	Range of motion	Controls aperture from 5-15 sigma (2-6mm full aperture), must float +/- 5mm as jaws are moved to follow beam drift	eliminated
Heat load	Steady state	11.3 kW	12.9kW
	Transient	56.5 kW	64.5kW
RF contacts	configuration	Sheet metal parts subject to CERN approval	New geometry

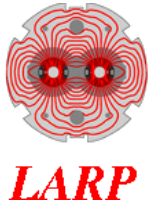

Heat deposited in major components (W/m³) in 1 hr beam lifetime operation

Component	Units	Upbeam	Downbeam
Stub shaft, aluminum	W/m ³	6.5e3	52e3
Bearing, Si ₃ N ₄	W/m ³	8.3e3	66.4e3
Image current bridge, aluminum	W/m ³	150e3	400e3
Mo shaft (~const in z, concentrated in $\phi=120^\circ$)	W	520	
Jaw, Glidcop AL-15 (heat highly variable in z and ϕ)	kW	12.8	

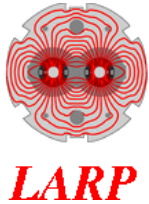

Major jaw dimensions and calculated cooling performance

Component	dimension	units
Jaw OD tangent to 20-faceted surface	136	mm
Jaw OD to facet vertices	137.7	mm
Jaw ID	66	mm
Jaw length, including 10mm (in z) x 15° taper on each end	930	mm
Mo Shaft OD	64	mm
Mo Shaft ID	44	mm
Hub length (centered)	150	mm
Cooling tube OD x ID (square x square)	10 x 7	mm
Embedded helix – center radius	80	mm
Helix – number of turns	~47	-
Cooling tube length – helix + entry + exit from vac tank	~16	m
Flow per jaw	9	l/min
Velocity	3	m/s
Water temperature rise (SS 12.8 kW per jaw)	20.3	C
Pressure drop	2.4	bar

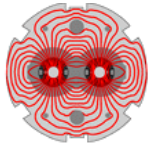

LARP

One Year Later...

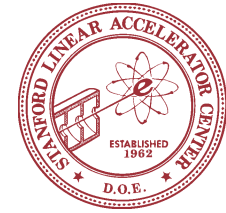

At June 2006 DOE Review we introduced

- New **jaw-hub-shaft** design which **eliminates central stop & flexible springs**
- New **reverse-bend winding concept** for the cooling coil which **eliminates the 3 end loops**, permitting longer jaws and freeing up valuable space for jaw supports, rotation mechanism and RF-features
- **Internally actuated drive** for rotating after beam abort damages surface

Main accomplishments in the last year

- Many test pieces manufactured and examined, tooling developed, and, especially, brazing protocols worked out
- Hundreds of 3-D concept & 2-D manufacturing drawings made
- Rotation & support mechanism fully designed and manufactured
- All parts for first full length jaw assembly manufactured & in-house
- Test lab fully wired, plumbed and equipped

BUT...

- Still have not brazed nor thermally tested a full length jaw assembly
- Still do not have a complete mechanical (=“RC1”) prototype

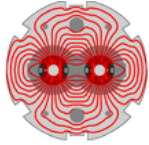

LARP

Summary of New Baseline Configuration

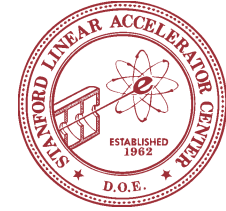

Jaw consists of a tubular jaw with embedded cooling tubes, a concentric inner shaft joined by a hub located at mid-jaw

- Major thermal jaw deformation away from beam
- No centrally located aperture-defining stop
- No spring-mounted jaw end supports

Jaw is a 930mm long faceted, 20 sided polygon of Glidcop

Shorter end taper: 10mm L at 15° (effective length 910mm)

Cooling tube is square 10mm Cu w/ 7mm square aperture at depth = 24.5 mm

Jaw is supported in holder

- jaw rotate-able within holder
- jaw/holder is plug-in replacement for Phase I jaw

Nominal aperture setting of FIRST COLLIMATOR as low as 8.5σ

- Results in minimum aperture $> 7\sigma$ in transient 12 min beam lifetime event (interactions with first carbon primary TCPV)
- Absorbed power relatively insensitive to aperture: for 950mm long jaw $p=12.7\text{kW}$ (7σ), $p=12.4\text{kW}$ (8.23σ)

Auto-retraction not available for some jaw orientations

Jaw rotation by means of worm gear/ratchet mechanism → “Geneva Mechanism”

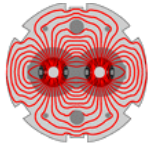

LARP

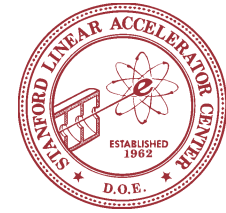

Cu-Mo Hub Braze Test parts

#2



- #1 - Mandrel Dummy (not shown)
- #2 - Mo Shaft Dummy
- #3 - Mo Backing Ring
- #4 - Cu Hub with braze wire grooves

#3

#4

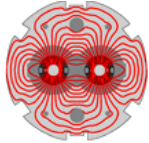

LARP

Up Beam Flex Mount – Rotation Assembly Complete

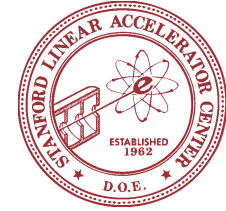

Design features that may not be apparent in the photos include:

- **Integral water cooling channel.**
- **Flexibility for length increase of the Collimator Shaft (proton load).**
- **Compensation for Shaft (in-plane) end angle rotation (sag).**
- **Flexibility for the +/- 1.5mm offsets required during “slewing”.**
- **Does not require an extra drive and control (uses existing systems).**
- **2.5mm motions advance the ratchet 1 “click”.**
- **512 “clicks” advance the Collimator to the next facet.**
- **Facet advancing is ~5% of the lifting load for Vertical Collimator**

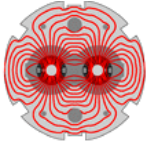

LARP

PLASTIC DEFORMATION of ENTIRE JAW after a BEAM ABORT ACCIDENT?

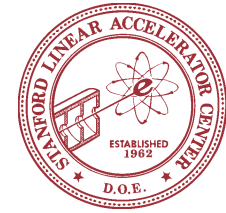

PRELIMINARY RESULT:

Doyle

- 0.27 MJ dumped in 200 ns into ANSYS model
- Quasi steady state temperature dependent stress-strain
 - bilinear isotropic hardening
- Result:
 - plastic deformation of 208 um after cooling, sagitta ~130um
 - Jaw ends deflect toward beam
 - Jaw surfaces at 90 to beam im

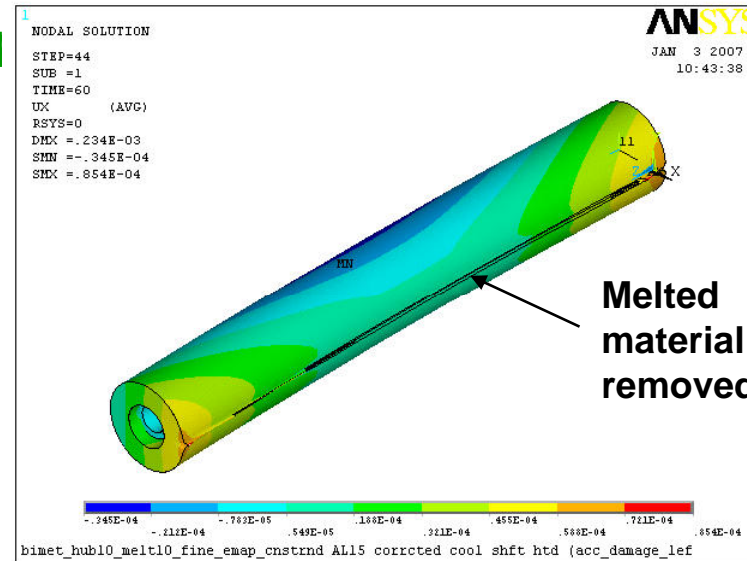
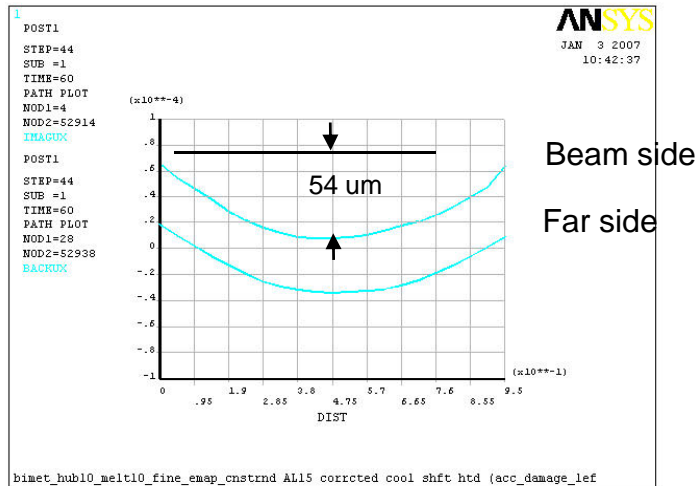

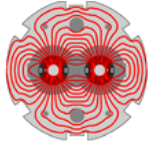

LARP

Impedance studies for Phase II collimators



Designing RF contacts for transition pieces.

What are the critical problem areas or design concerns?

What is the maximum taper angle? Can we use greater than 15 degrees over short distances?

Are trapped modes/heating a concern?

MAFIA simulations

Compare geometric impedance between Phase I and Phase II collimators. Our odd geometry increases/decreases geometric wakes by how much?

Include resistive wall surfaces and contacts to look at surface resistance contribution to impedance.

Impedance measurement test stand

Similar studies as performed at CERN for Phase I.

Measure RF contact resistance for our transition piece.

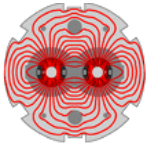

LARP

RF geometry at beam mid-plane

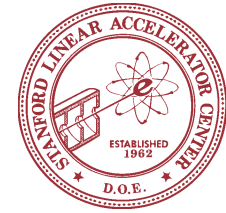

Offset position is 5mm beyond beam centerline

Angles are sphere end tangents at 10mm and 2.5mm from beam

