

SEEK FOR PERFECTION



Combining expertise and experience

- Coronaria Instruments has a solid reputation as a global developer and manufacturer of surgical instruments and implants. The company has years of experience and references for delivering solutions for customers all over the world.
- Oulun Hienomekaniikka has 29 years of experience in machining demanding components, modules and entire product families for healthcare, defence and other industries.
- **Mectalent** was born in 2008 when two companies Coronaria Instruments and Oulun Hienomekaniikka were merged.
- 47 employees, turnover 5,6 M€ (2011)
- Member of Cor Group Oy



- Designing
- Machining
 - Surgical instruments, implants and equipments for med-tech
 - Components for defence industry
 - Special parts for aviation industry
 - 5- axis machining
 - Machining components
- Assembly
- Testing
- Maintenance

Challenge of machining

Good to know

- Customer oriented approach
- Designing know-how
- Overall equipment effectiveness
- State of the art team for machining solution

Mectalent well-known

- Specialist
- As a reliable partner
- Offers its customers the unique ability to design and produce solutions

Customers

SBA		
SBA1	Healthcare	GE Healthcare, PaloDEx, Perkin Elmer Wallac, Innokas Medical, Philips Medical Systems, ConMed Linvatec Biomaterials
SBA2	Industrial	Finn-Power, Noptel, John Crane Safematic, Dekati, Valmet Automotive
SBA3	Defence	Patria Land Services, Reifer, Luvata Pori, Environics, Sako
SBA4	Aviation	ThyssenKrupp Aerospace, Patria Aerostructures, Patria Aviation

Quality

- Certified quality system
ISO9001 (DNV, 2006) ISO13485 (DNV, 2010)
- Upcoming certification:
ISO14001 (DNV2012)
- Other requirements (not certified):
AQAP2110, Nato quality requirements
EN9100, Aviation quality requirements

Turnover

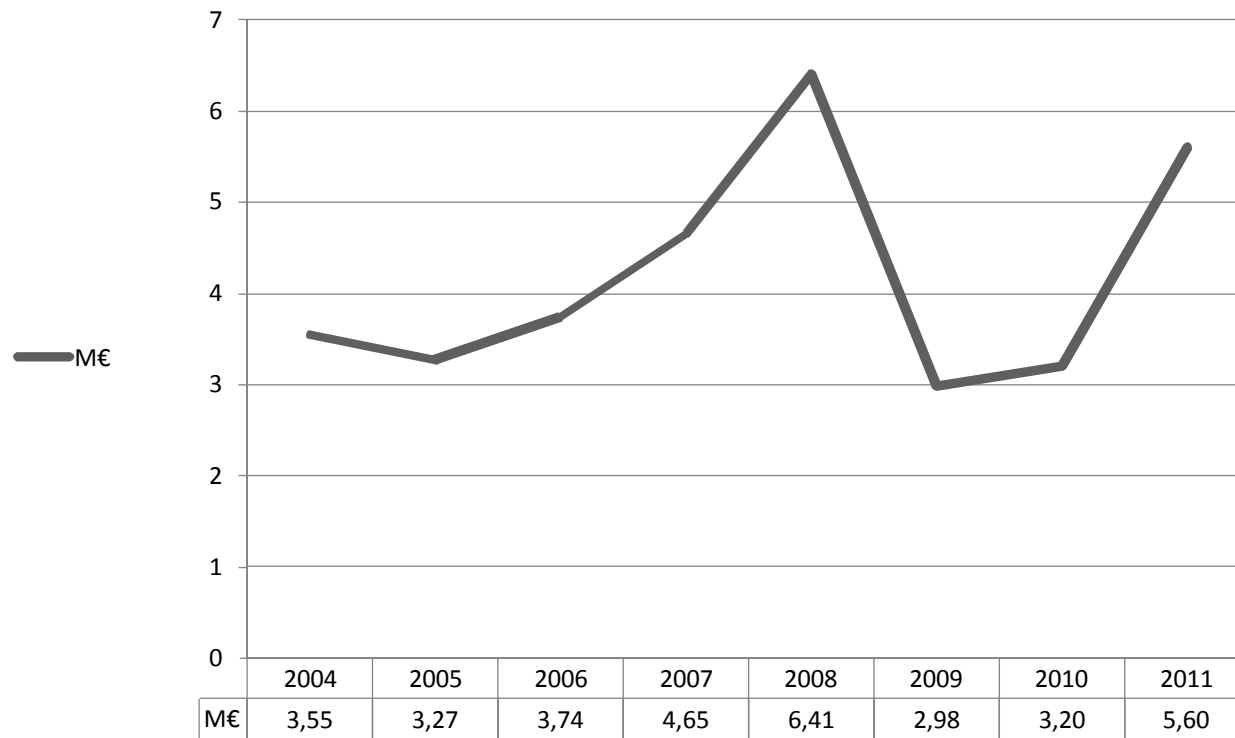

mectalent

Cor Group Oy

MEDIA

Verkossa Media Oy
Coronaria Media Oy
Darwin Oy
Darwin Food Consulting
Pilgrim Consulting Oy
Darwin Producers Oy
Webmark Oy
Versus Digital Oy

CORONARIA

Coronaria Feedback Oy
Coronaria Impact Oy
Coronaria Tervekauppa Oy
Coronaria Consulting Oy
Coronaria WellCare Oy
Professio Finland Oy

Coronaria Hoitoketju Oy
Suomen radiologipalvelu Oy
Coronaria Kirurgia Oy
Coronaria Optical Itäkeskus Oy
Coronaria Optical Rovaniemi
Coronaria Optical Pirkkala Oy

TEKNOLOGIA

Coronaria Optical Oy Mectalent
Coronaria Optical Orivesi Oy

Coronaria Optical Tampere Oy
Coronaria Optical Vaasa Oy

KIINTEISTÖT

KIOy Savutoppila
Coronaria Instruments Oy

SEEK FOR PERFECTION



Technology

- **Spring**
 - Before made from wire
 - Test 400mil. 200Hz-> Micro failures
 - Now made from block by milling
 - Carbon coating
 - Sewed in the sock
 - Around 10 different sizes
 - Very long project over five year!

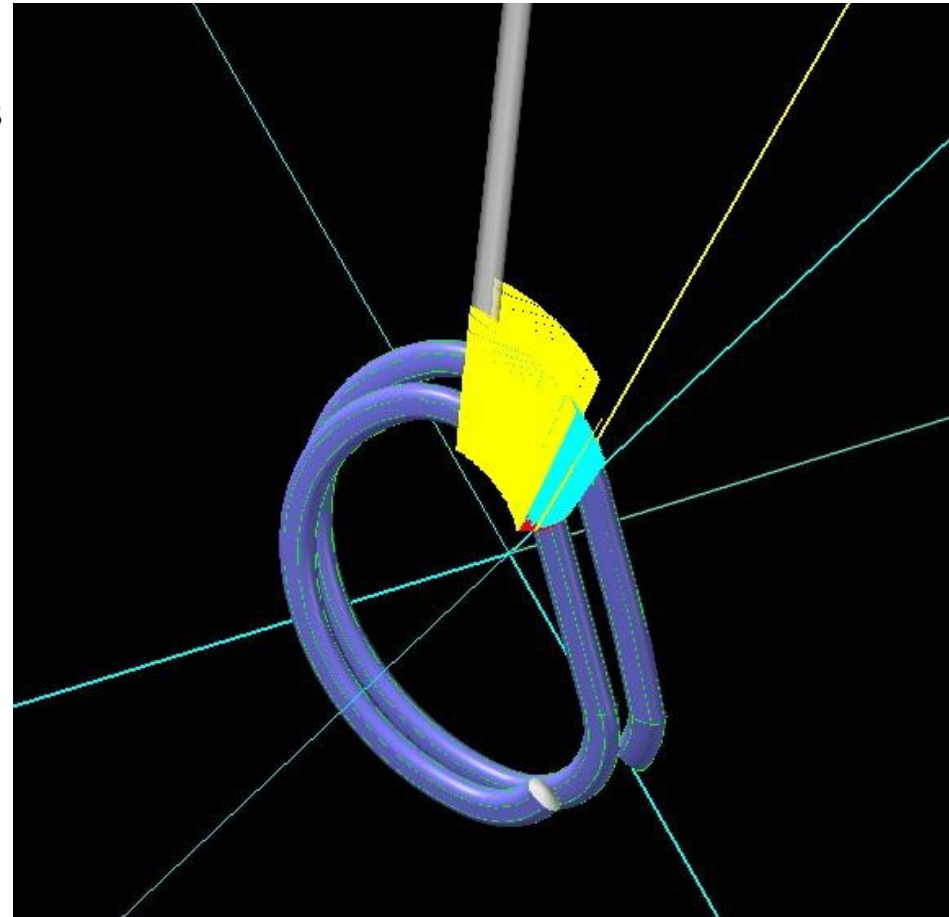

- **Block**
 - **Customer material**
 - **Ultrasonic inspection**
 - **Machining**
 - **Heat treatment**
 - **Machining**
 - **Wire EDM**
 - **Machining**
 - **EDM**
 - **3D measuring**
 - **Painting**
 - **Assembly**
 - **Finish inspect**

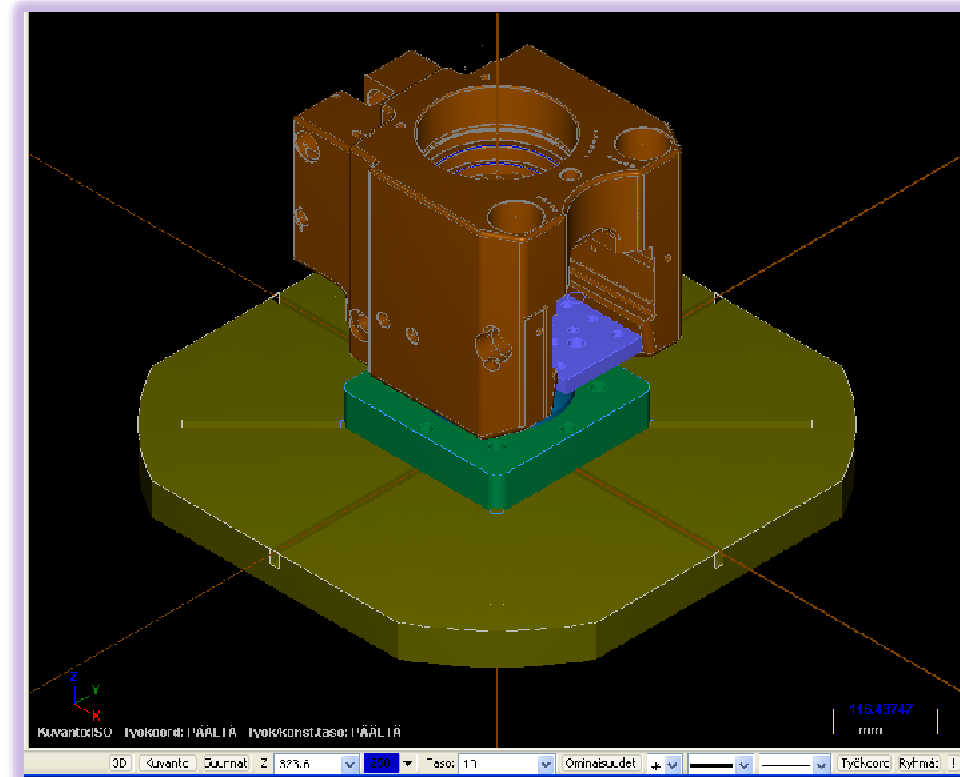

- **Assemblies**
 - **Atomic Layer Deposition ALD**
 - **Radar PSR Transmitter**
 - **Micromanipulator**

mectalent

**Atomic Layer Deposition
ALD**

mectalent

Radar PSR Transmitter

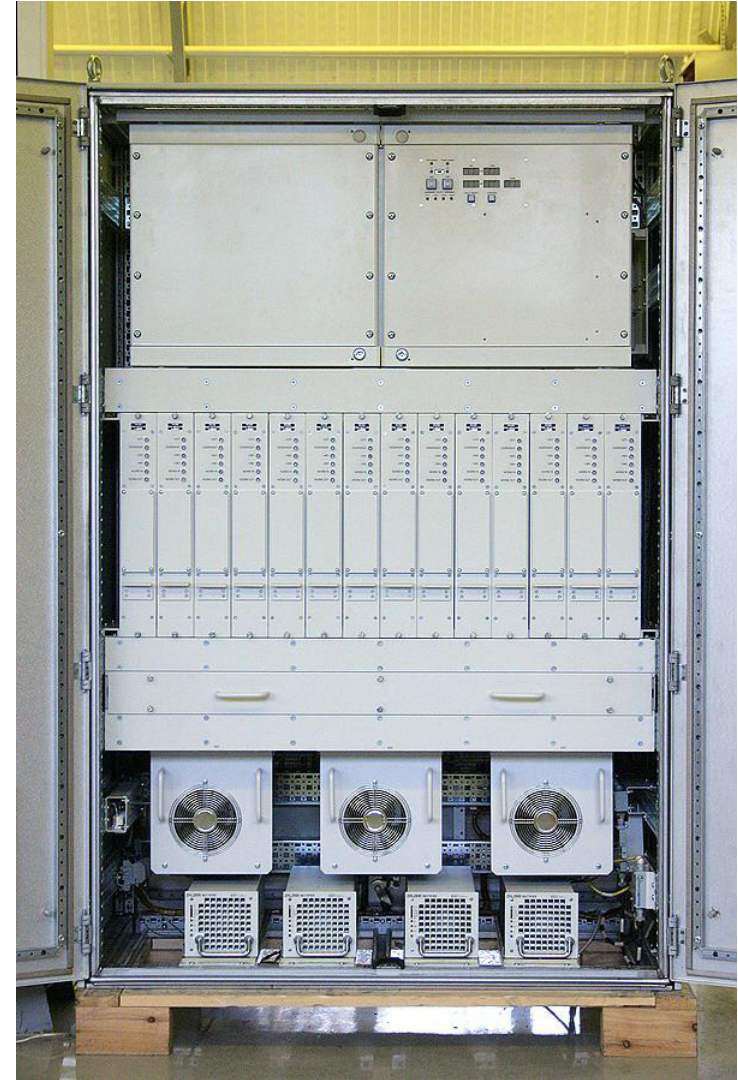
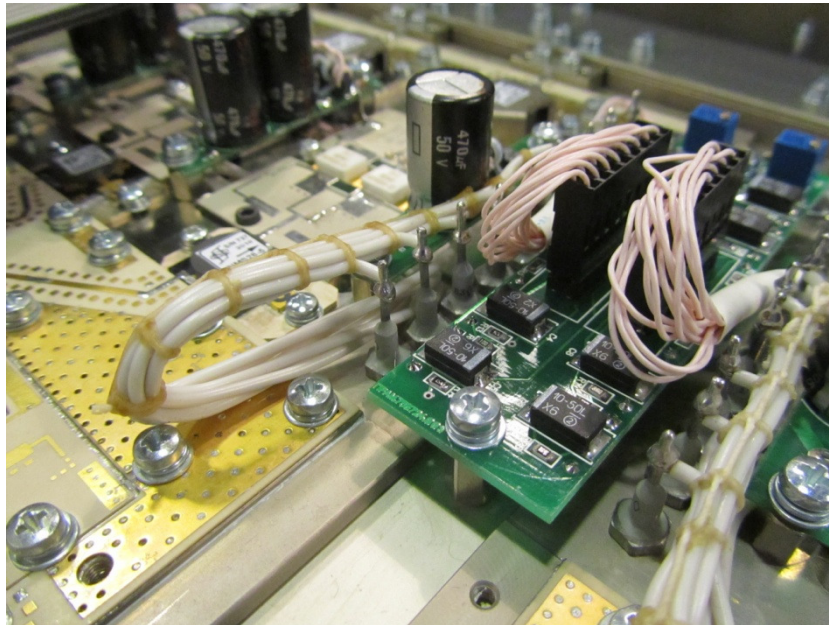
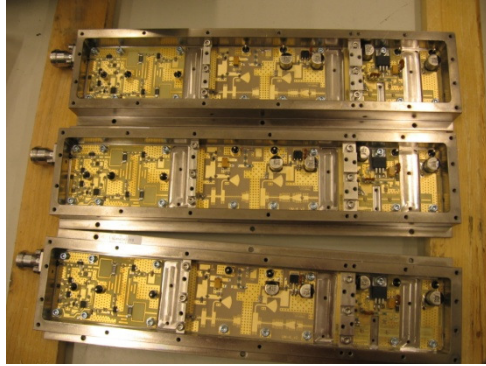

mectalent

Micromanipulator

Assembly and test

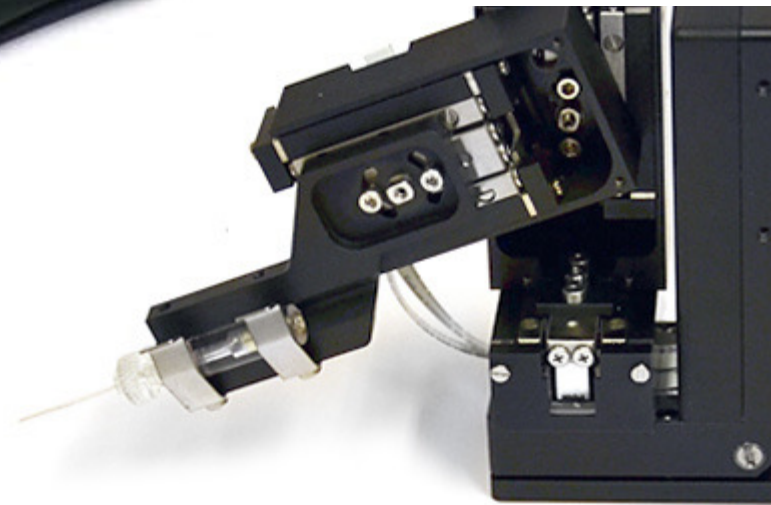
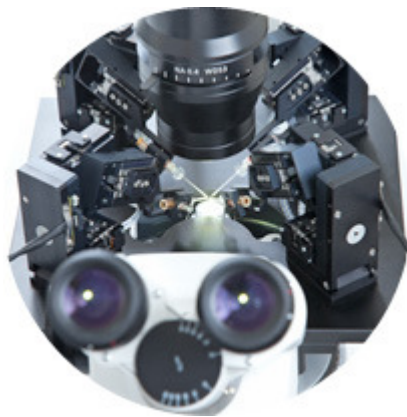
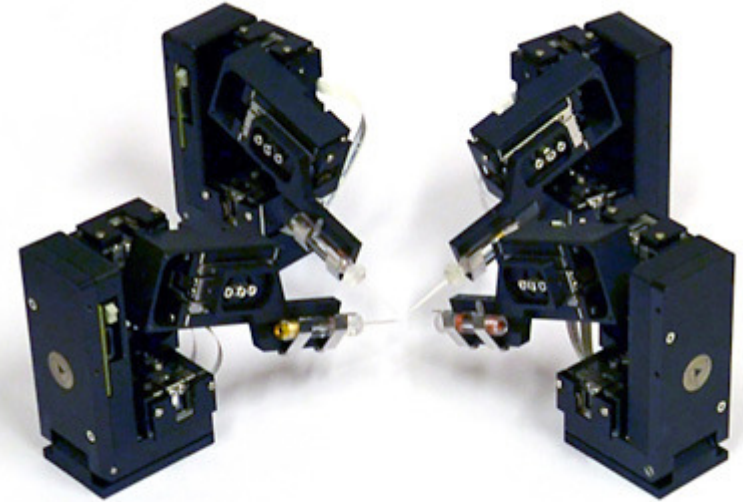

mectalent

Medical



mectalent

Medical instruments



SEEK FOR PERFECTION 



mectalent

Medical instruments



mectalent

Medical instruments

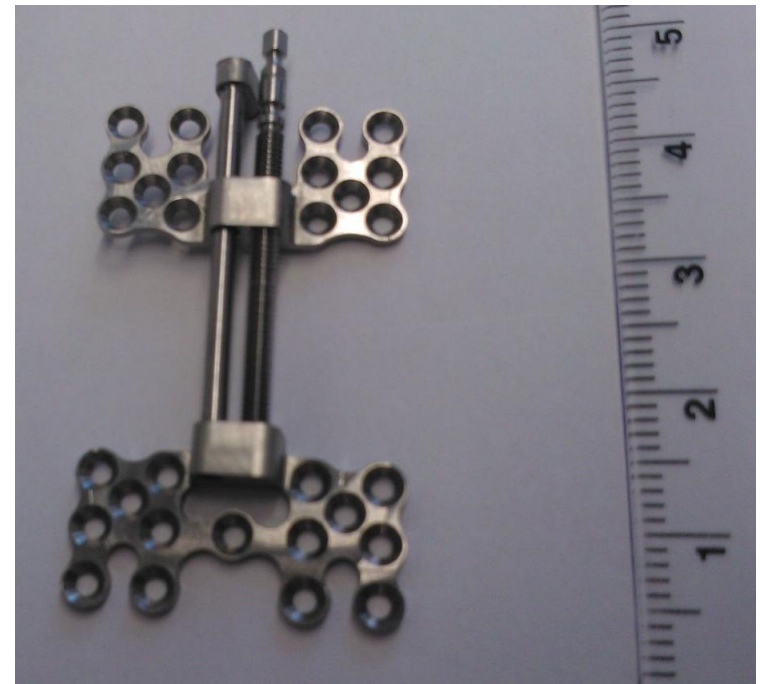
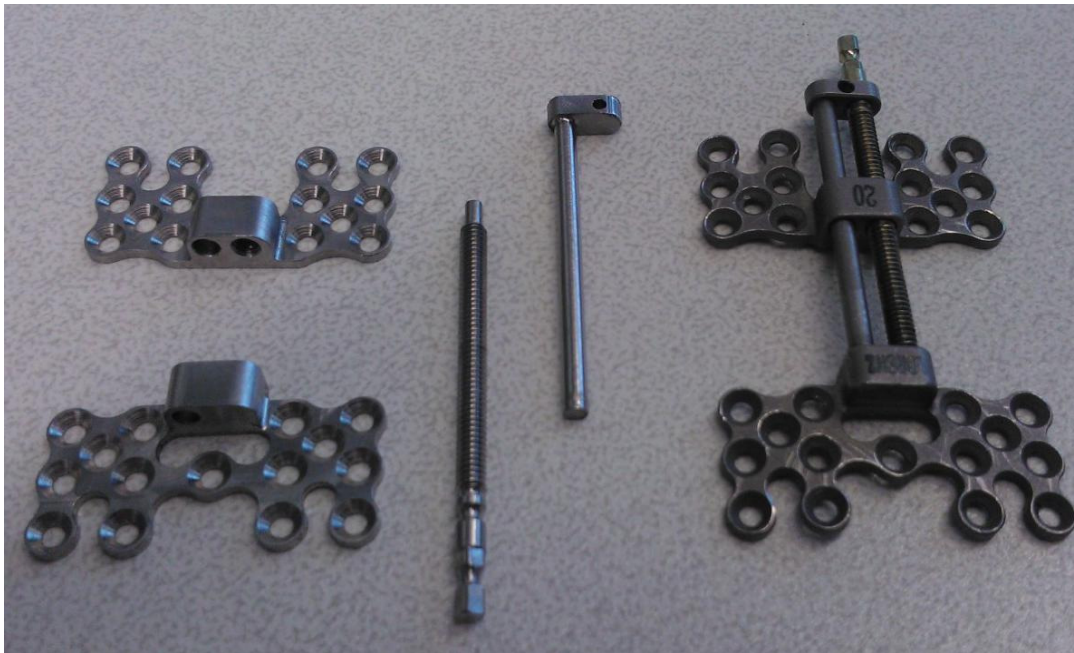

mectalent

Medical instruments



mectalent

Surgical instruments



SEEK FOR PERFECTION



mectalent

Medical instruments



SEEK FOR PERFECTION



mectalent

Medical parts

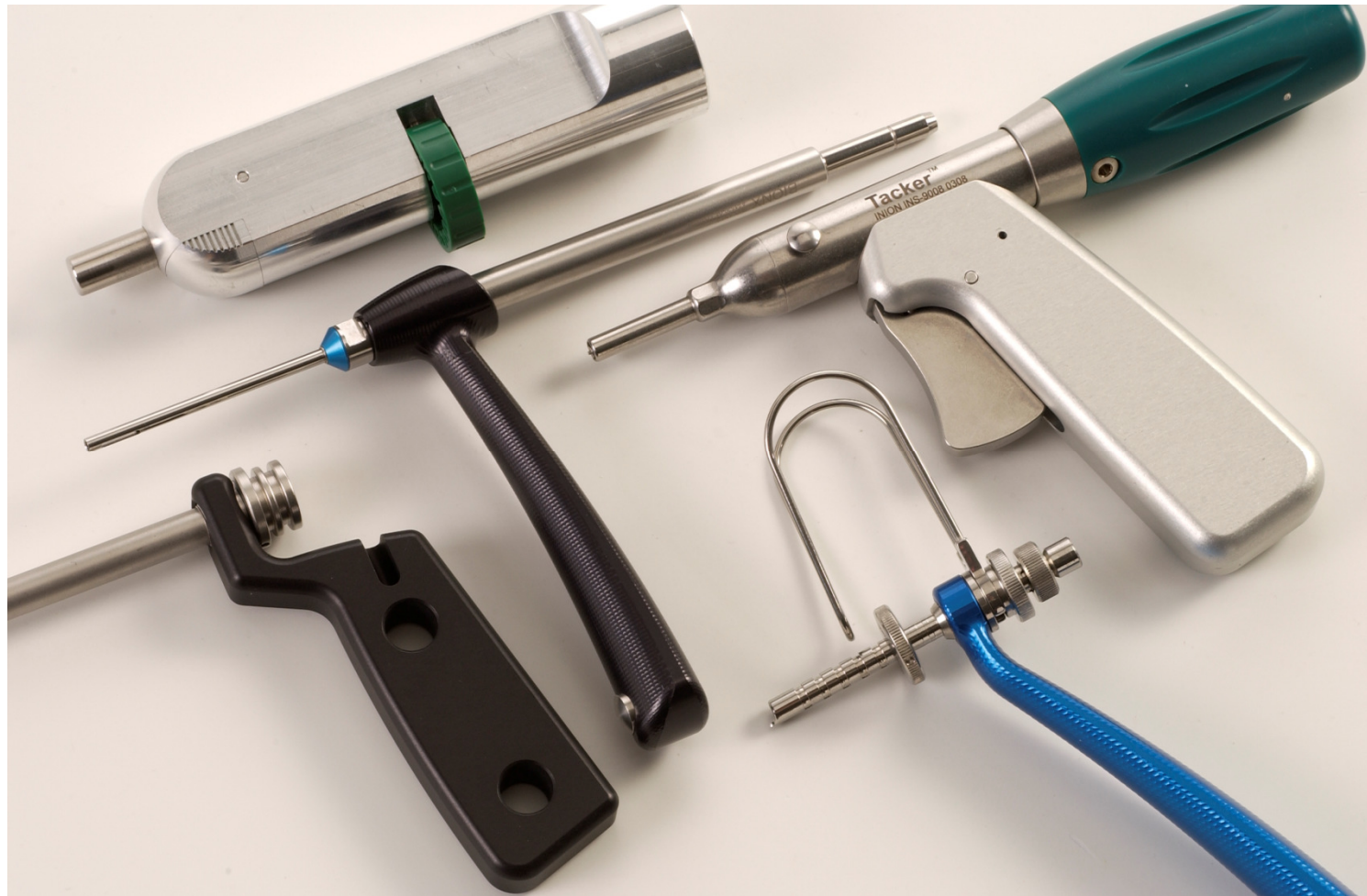

mectalent

Small machined parts



mectalent

Aviation



SEEK FOR PERFECTION



mectalent

Spesial parts

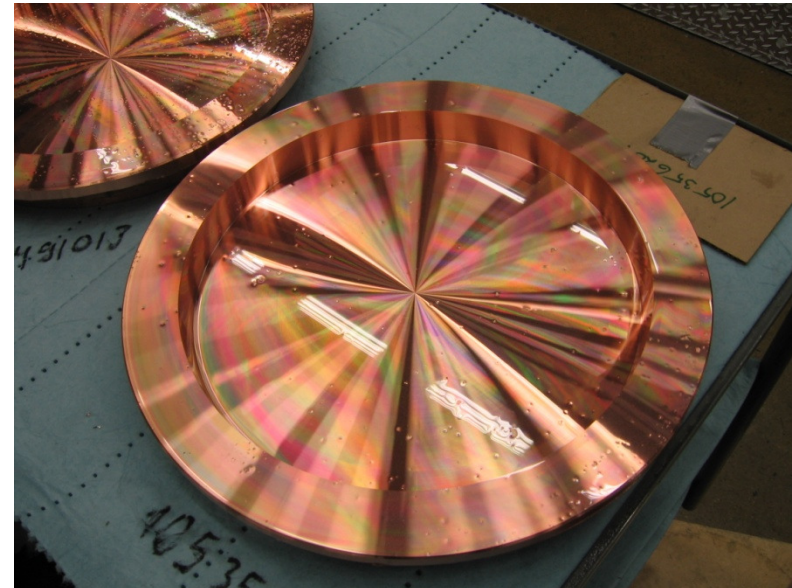

mectalent

Machines and devices

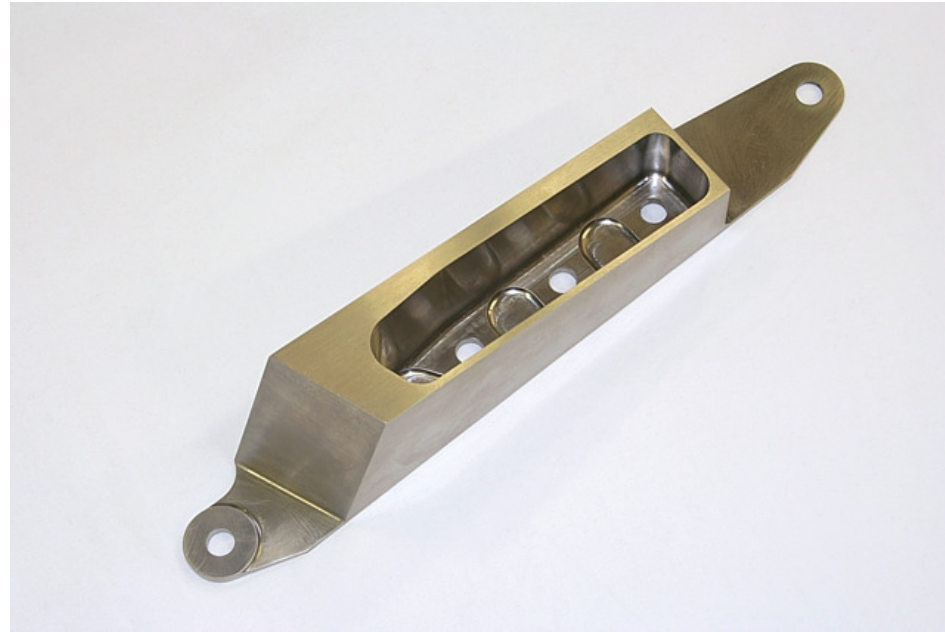

mectalent

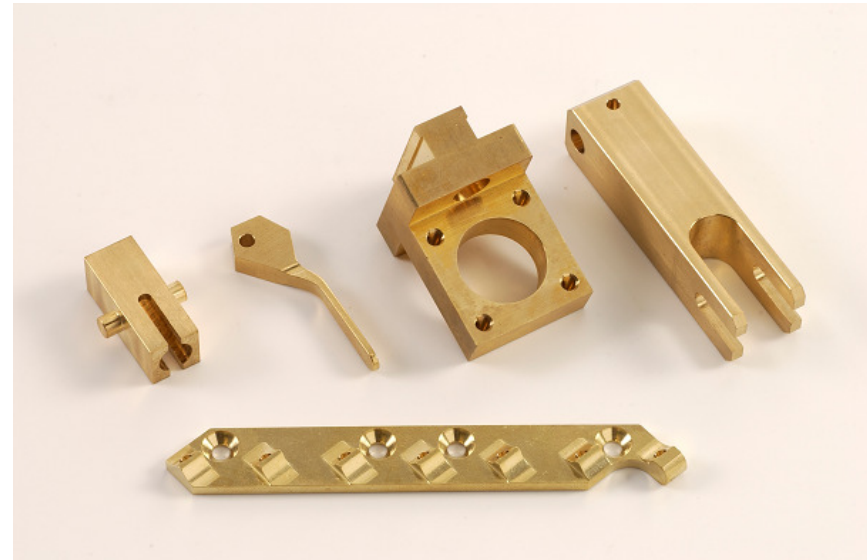

mectalent

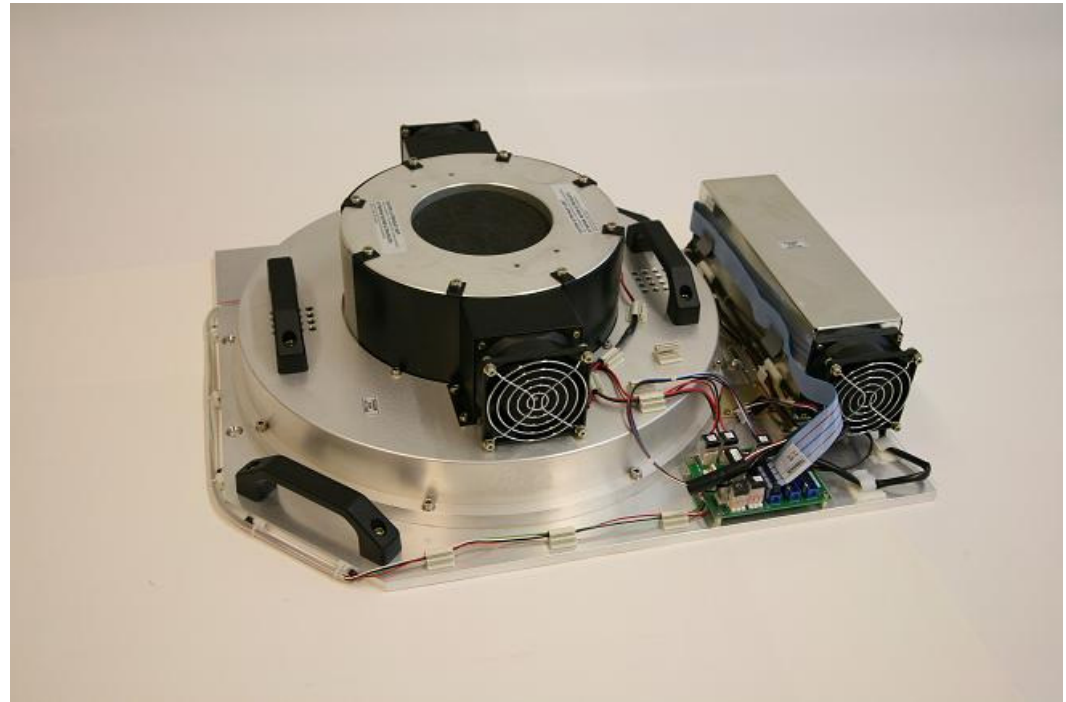
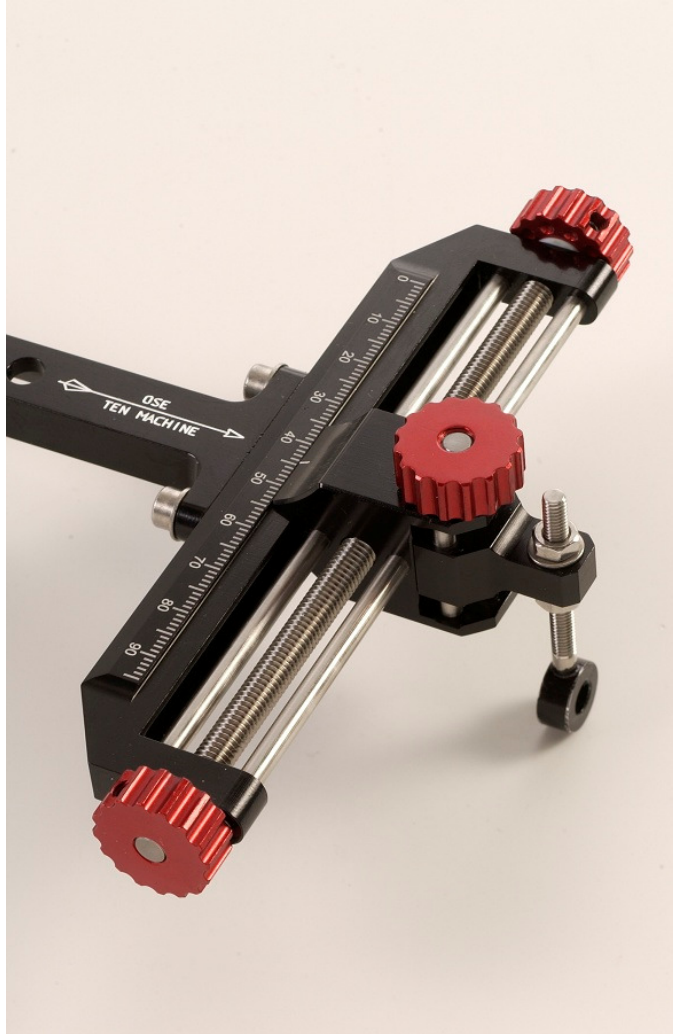

SEEK FOR PERFECTION



mectalent

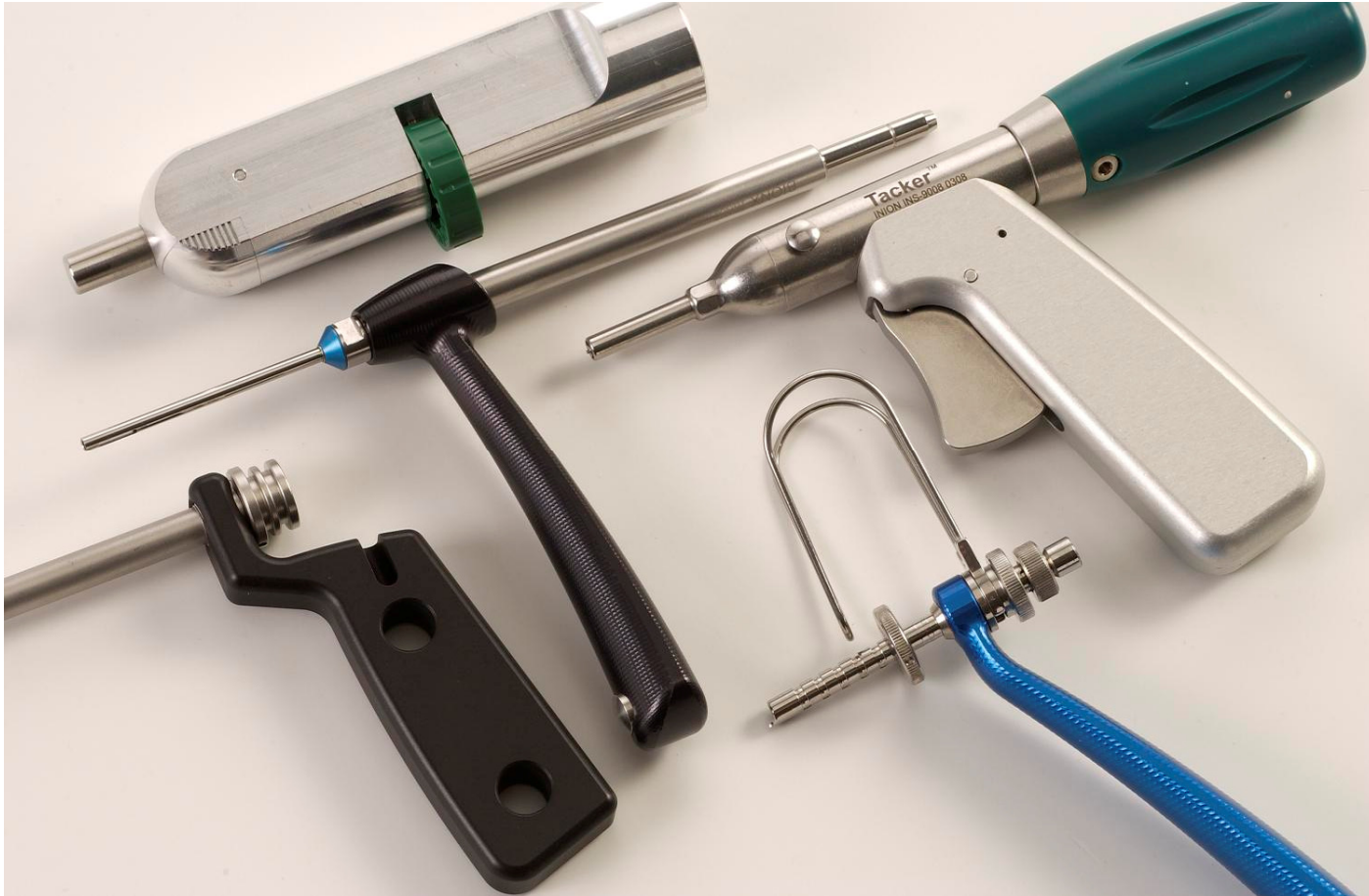

mectalent



SEEK FOR PERFECTION



mectalent

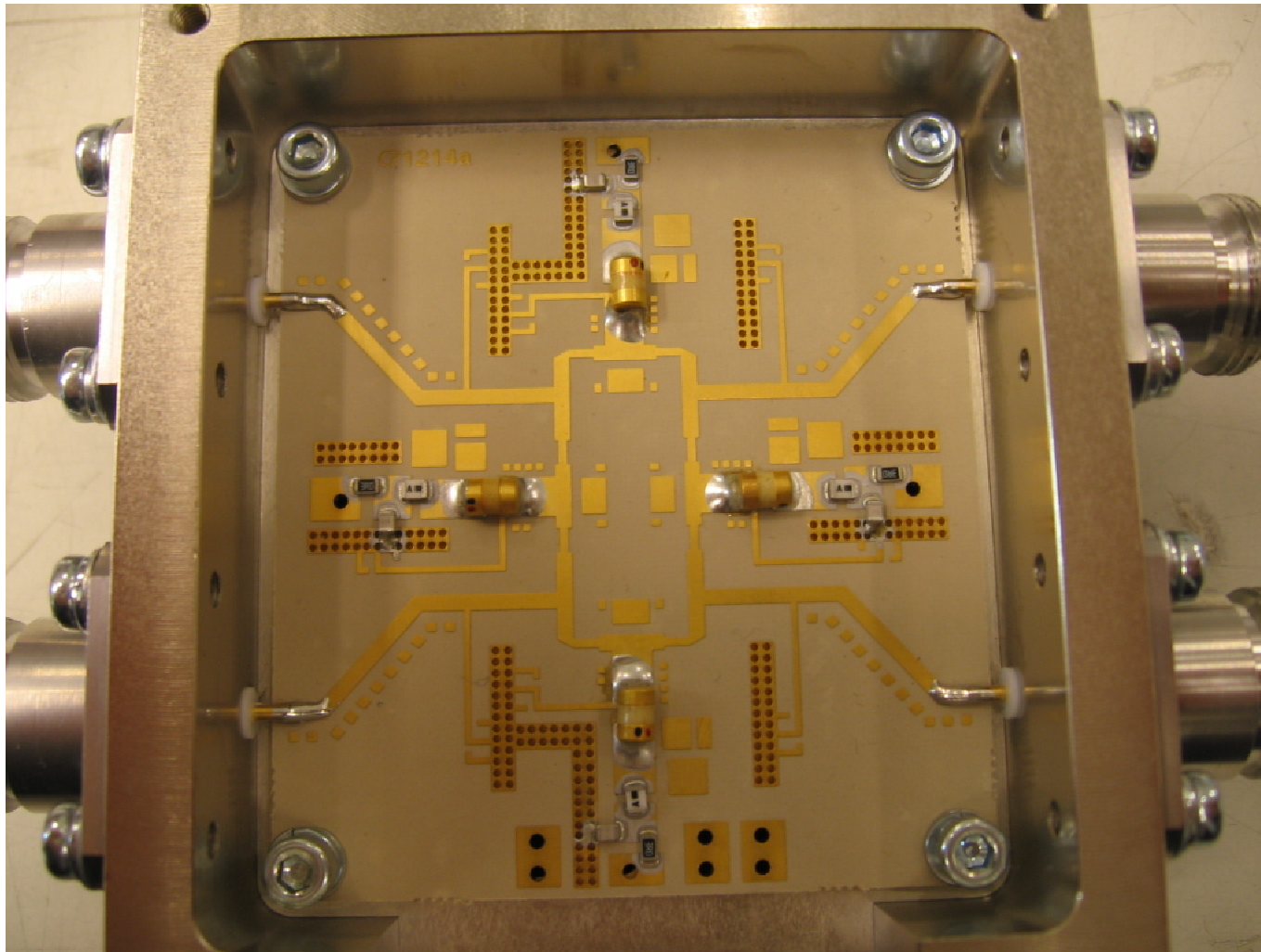

mectalent



mectalent

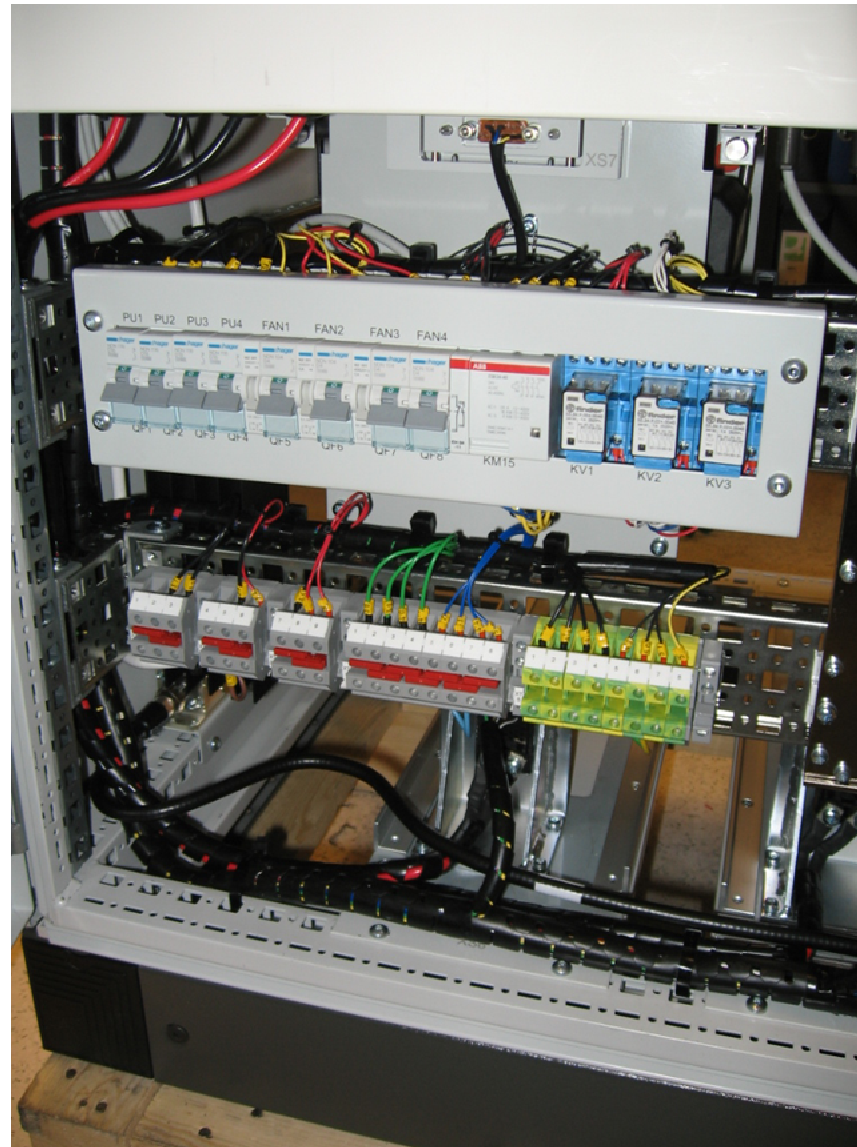

mectalent

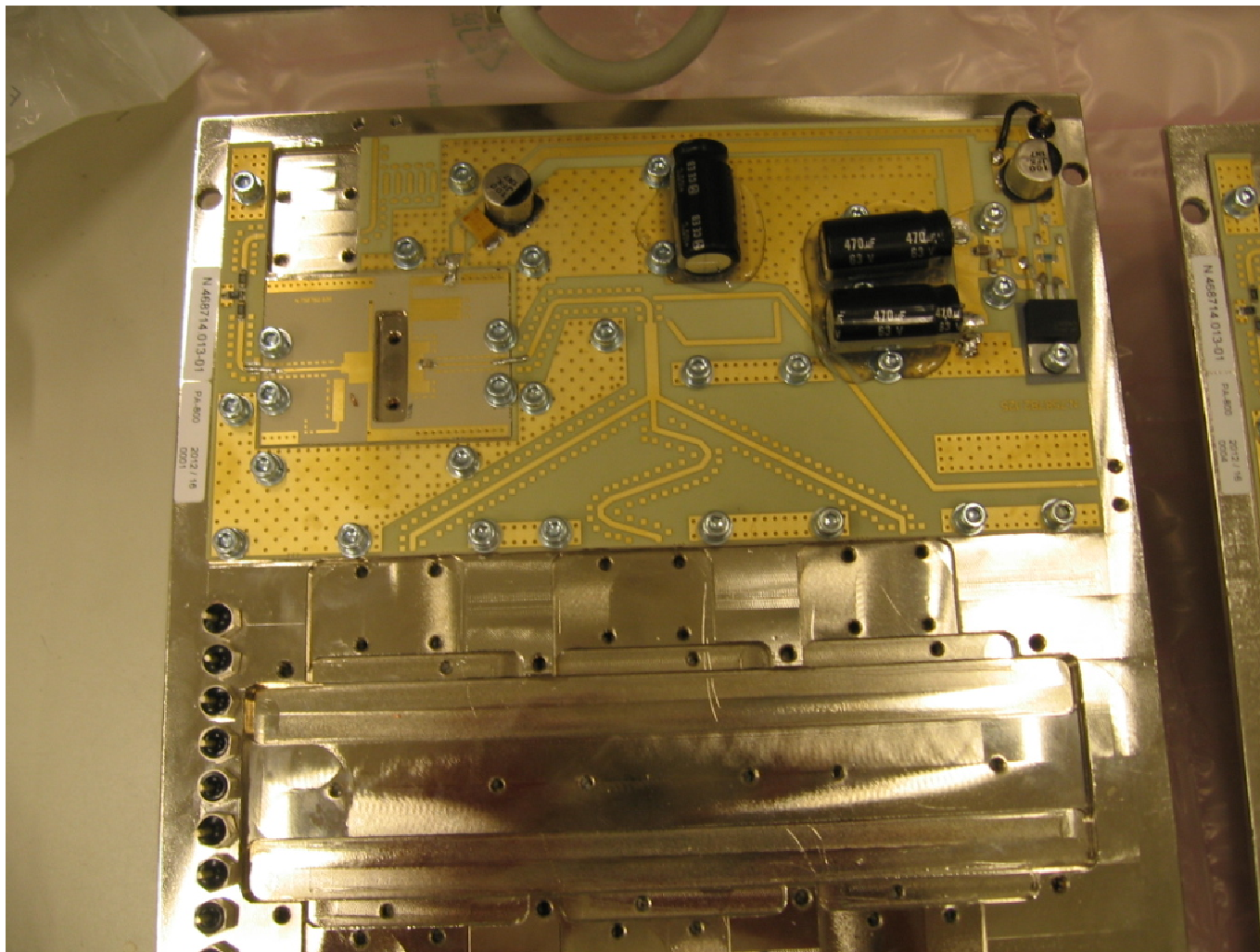

mectalent

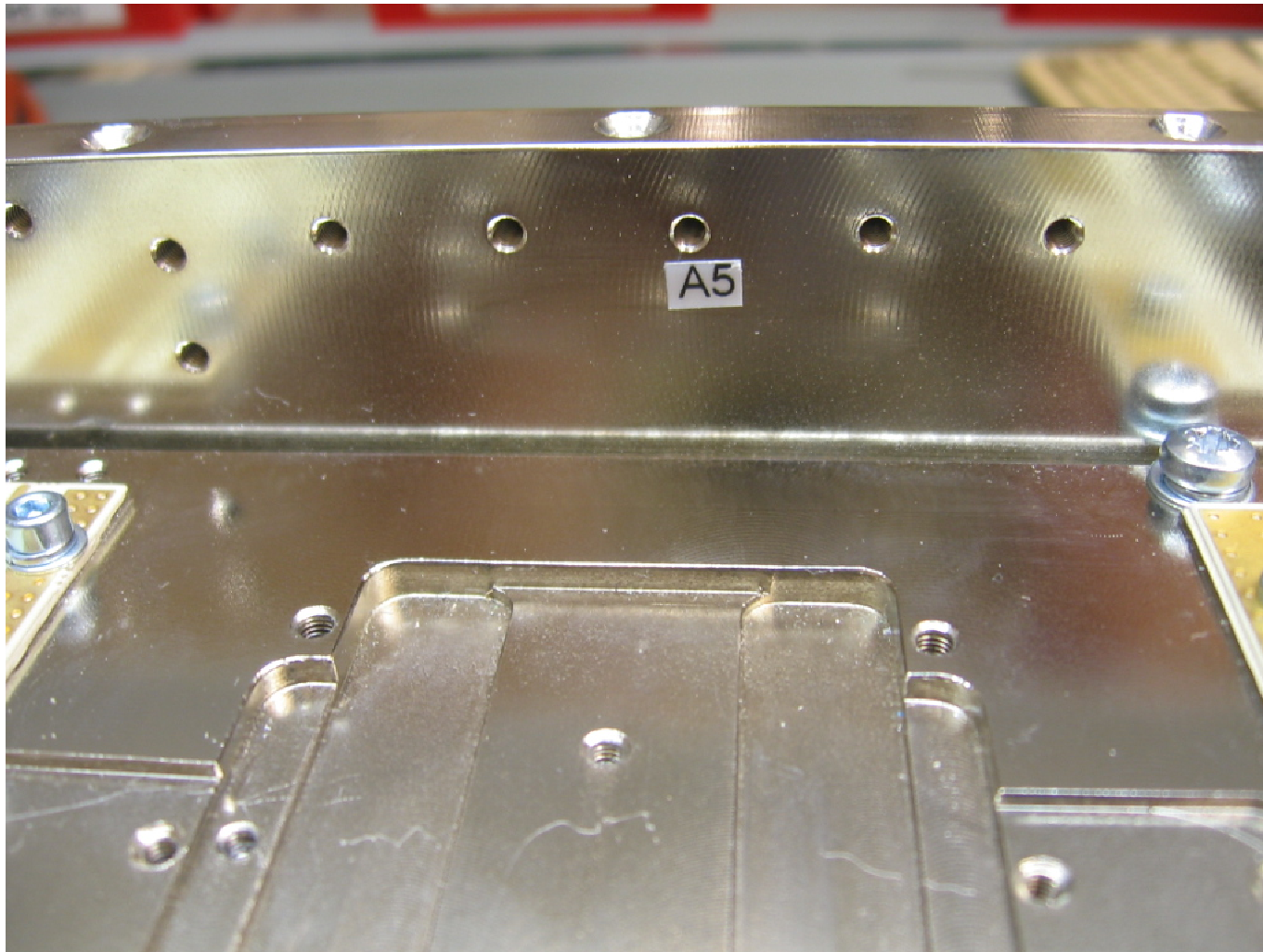

mectalent

