

The physics goals of the Large Hadron Collider (LHC)

HST06, July 11-12 2005

Michelangelo Mangano
Physics Department, CERN
michelangelo.mangano@cern.ch

Key questions addressed by high-energy physics

a.k.a. “particle physics”

- **What is the Universe made of?**
- **How does it work?**
- **Why?**

Level 0: what? how?

- Are there fundamental building blocks?
- If so, what are they?
- How do they interact?
- How do they determine the properties of the Universe?

The fundamental building blocks: fermions, spin = $1/2 \hbar/2\pi$

Quarks		Leptons	
$Q=2/3 e$	$Q=-1/3 e$	$Q=-e$	$Q=0$
up (0.004)	down (0.006)	e (0.0005)	ν_e (very small*)
charm (1.5)	strange (0.5)	μ (0.1)	ν_μ (very small)
top (175)	bottom (4.5)	τ (1.8)	ν_τ (very small)

ordinary matter



identical copies
(different mass)

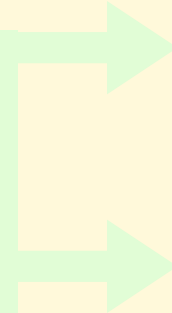

(Mass values in GeV)

* *very small*: less than 10^{-9} ,
but different from 0

The fundamental interactions:

vector bosons, spin= $h/2\pi$

FORCE	COUPLES TO:	FORCE CARRIER:
Electromagnetism	electric charge	photon ($m=0$)
“weak” force	“weak” charge	W^\pm ($m=80$) Z^0 ($m=91$)
“strong” force	“colour”	8 gluons ($m=0$)

tensor boson, spin= $2 h/2\pi$

gravity	energy	graviton ($m=0$)
---------	--------	--------------------

scalar boson, spin=0

	mass	Higgs ($m=??$)
--	------	----------------------------------

Lepton Interactions ($l=e,\mu,\tau$)



$\propto -e = \text{electric charge}$

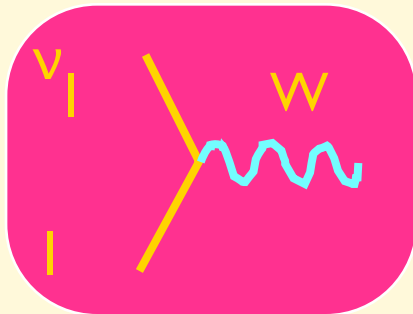

$\propto g_W = \text{weak charge}$

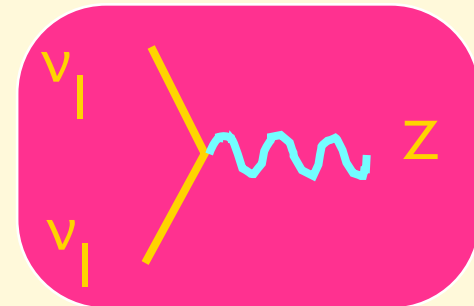

Quark Interactions

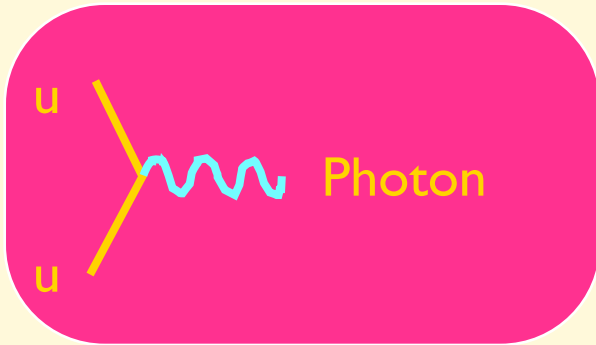

$$\propto 2/3 e$$

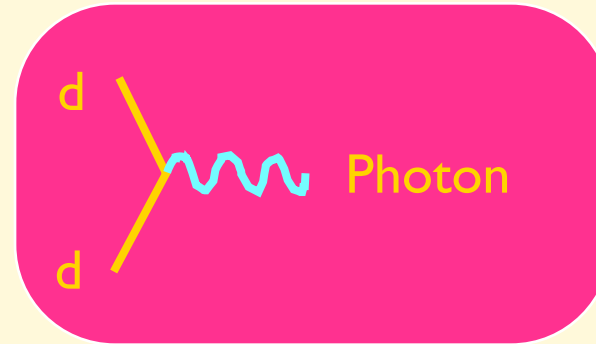

$$\propto -1/3 e$$

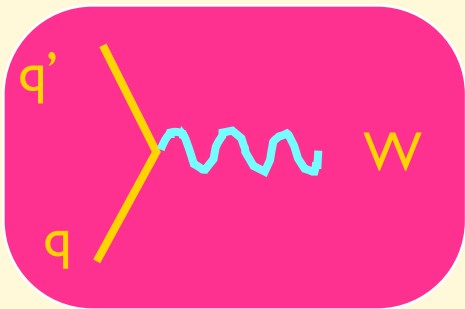

$$\propto g_w M_{qq'}$$

$M_{qq'}$	u	c	t
d	0.97	-0.22	~ 0.001
s	0.22	0.97	~ 0.05
b	~ 0.001	~ 0.05	~ 1



$$\propto g_s = \text{strong coupling}$$

Level 1: Why?

- Why gauge theory?
- Why 3 families of quarks and leptons?
- Why some particles have mass?
- Why $m(\text{neutrino}) \sim 10^{-7} m(e)$?
- Why is there a matter-antimatter asymmetry in the Universe?
- Why $F_{\text{gravity}} \sim 10^{-40} F_{\text{electric}}$?
- Are particles really pointlike? Strings?? Membranes?
- Why $D=3+1$?
-
- Why something instead of nothing?

The depth of “Why?” questions is a measure of the maturity of the field. We can only approach “why” questions when we have a solid understanding of the “what”’s and “how”’s

Example: mass

$\mathbf{m=E/c^2}$ \Rightarrow for a composite system the mass is obtained by solving the dynamics of the bound state

So $m_p = 938$ MeV requires a “how” explanation, not a “why” one

But what about elementary particles? Elementary
 \Rightarrow no internal dynamics

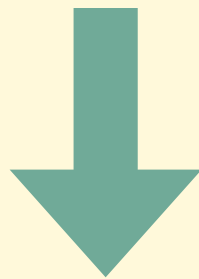

Need to develop a new framework within which to understand the value of the electron mass

Example of scientific progress

Components:

air, water, fire, earth

Forces:

- air and fire pushed upwards
- earth and water pulled downwards

Experimental detection of anomalies in the prediction:

how come a tree falls in the water, but then gets pushed up and floats?

Reevaluation of the theory, a new synthesis (Archimedes)

- **all** matter is pulled downwards, but with intensity proportional to its weight:

A body immersed in water receives a push upwards equal to the weight of the displaced water

Air is lighter than the rock, therefore it floats on top of it. Warm air is lighter than cold air, and by it it's pushed up.

A first example of unification of forces and elements!

The goals of the LHC

- To firmly establish the **“what”**:
 - discover the crucial missing element of the Standard Model, namely the **Higgs boson**
 - search for possible **new fundamental interactions**, too weak to have been observed so far
 - search for possible **new generations** of quarks or leptons
 - confirm/disprove the **elementary nature** of quarks/leptons
 - discover direct evidence for the particle responsible for the **Dark Matter** in the Universe
- To firmly establish the **“how”**: the observation of the Higgs boson, and the determination of its properties, will complete the dynamical picture of the Standard Model, confirming (hopefully!) our presumed understanding of **“how” particles acquire a mass**.
- To seek new elements which can help us shedding light on the most difficult question, namely **WHY?**

LHC in a nutshell

- 2 beam of protons, circulating in two magnetized rings of 27km, steered by 1200 16m dipoles, 9Tesla, operating at 1.5°K
- proton-proton collisions, at $\sqrt{S}=14 \text{ TeV}$ ($=14 \times 10^6 \text{ MeV!}$)
- 10^8 proton-proton collisions per second
- event size: **1MB**, event storage rate: **100Hz**, data to tape: **10^6 GB/yr**
- Experiments:
 - **ATLAS** and **CMS** (general purpose)
 - **LHCb**: physics of b-quark hadrons
 - **ALICE**: heavy ion (Pb) collisions at 5.5TeV/nucleon
- Expected starting date: 2007

To understand how the LHC is going to shed light on these issues, let us explore more in depth what are the “observable” quantities studied by LHC physicists, and how proton-proton collisions work

Observables and fundamental quantities

■ *Mass:*

- Composite particles -> dynamical origin, calculable: $M=E/c^2$, $E=T+U$
- Fundamental particles -> assigned parameter; origin ???
- Measurement:
 - in decays: $P=\sum p_i$, $M^2=P^2$
 - in production: M =minimum energy necessary for creation

■ *Charge:*

- Which type (electric, weak, strong)?
- Are there other charges?? What is the origin of charge??
- Measurement: interaction strength
 - lifetime of a particle before its decay
 - reaction probabilities (rate counting)

■ *Spin* (intrinsic angular momentum):

- Integer-> bosons, Semiinteger -> fermions
- Origin??
- Pauli principle (two identical fermions cannot occupy the same quantum state) at the origin of matter stability and diversity
- Measurement: angular distributions in scattering or decay processes

Examples of mass determination: M= energy at production threshold

Production rate for $e^+e^- \rightarrow \text{hadrons}$, as a function of the center of mass energy

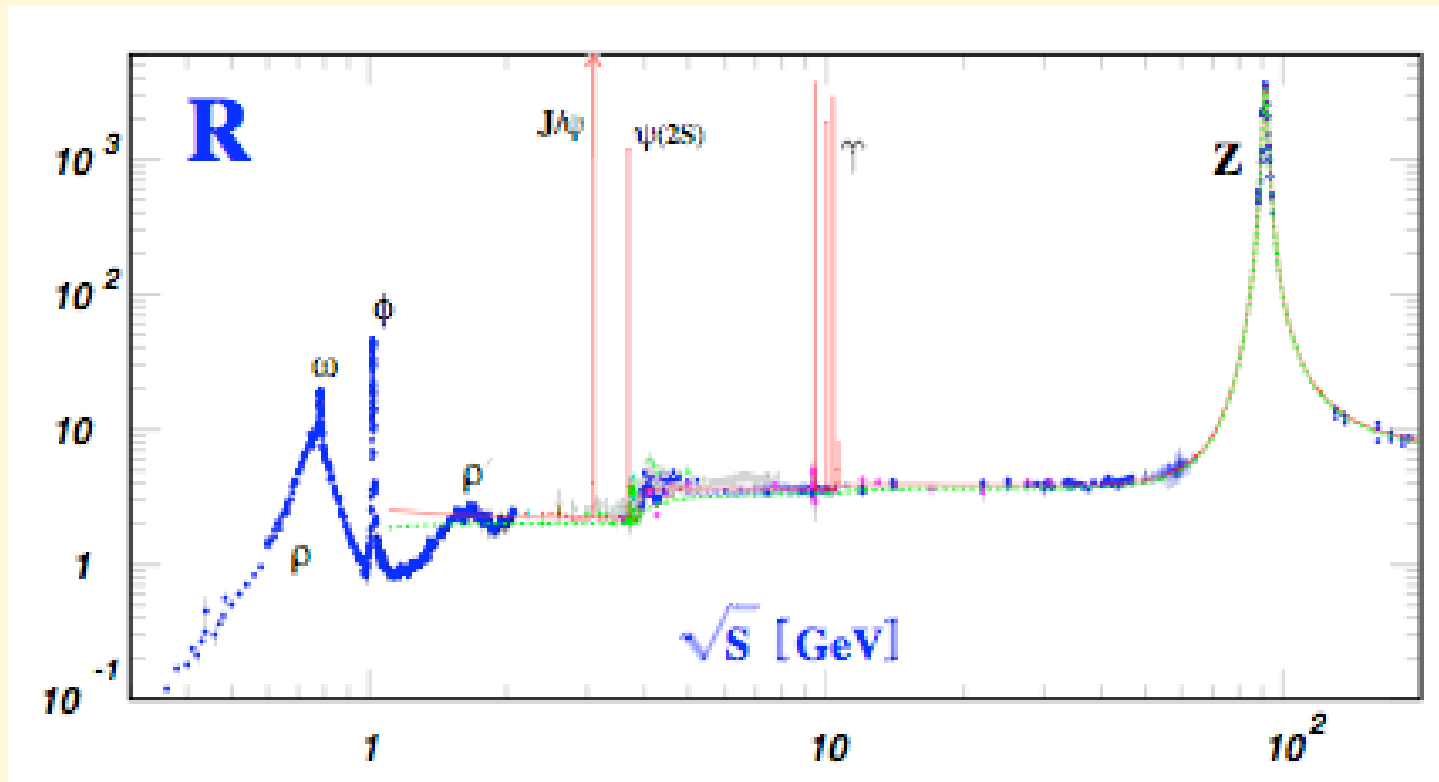

The peaks represent the appearance of a new possible final state, made it possible by having enough CM energy to create it

Examples of mass determination: top quark kinematic reconstruction

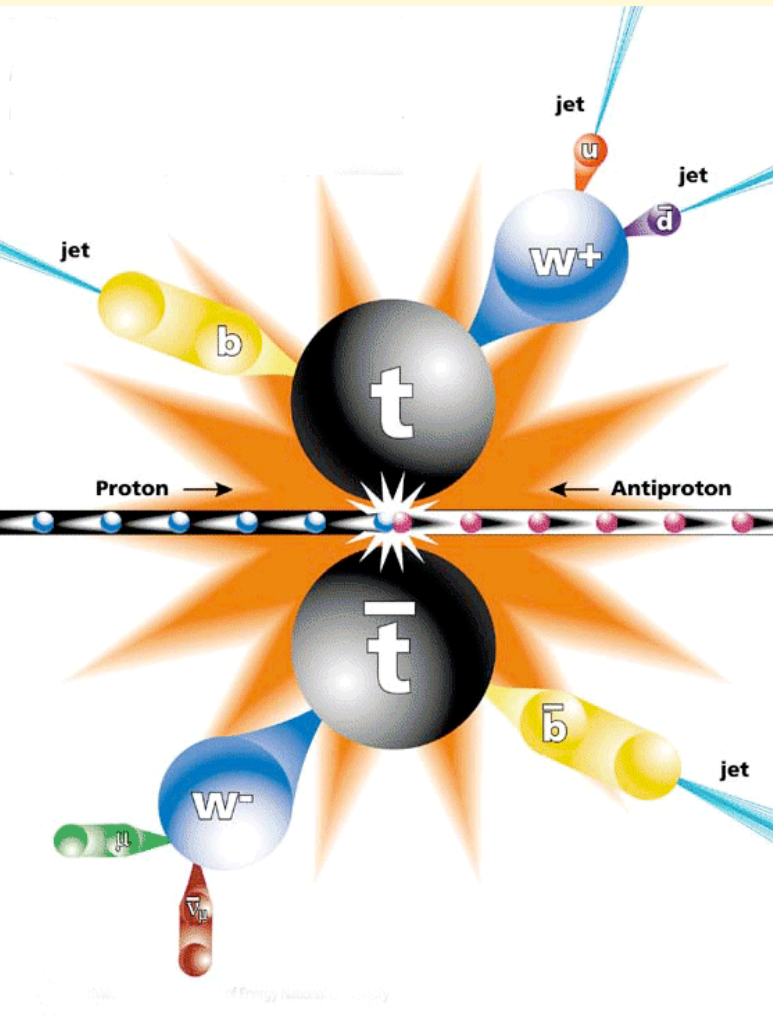

top \rightarrow bottom + W

followed by $W \rightarrow l \nu$ ($l=e, \mu, \tau$)

or

$W \rightarrow q \text{ anti}q$

e + 4 jet event

40758_44414

24-September, 1992

TWO jets tagged by SVX

fit top mass is 170 ± 10 GeV

e^+ , Missing E_T , jet #4 from top

jets 1,2,3 from top (2&3 from W)

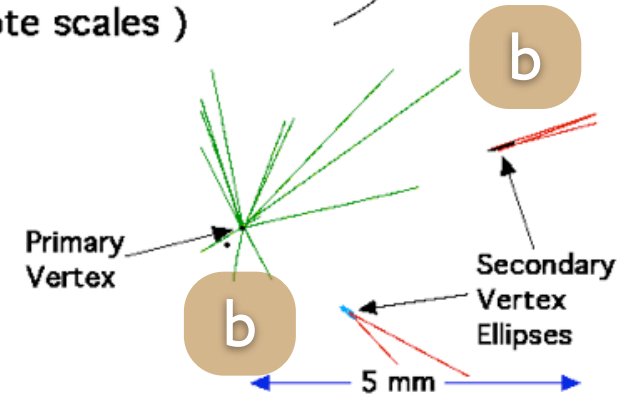
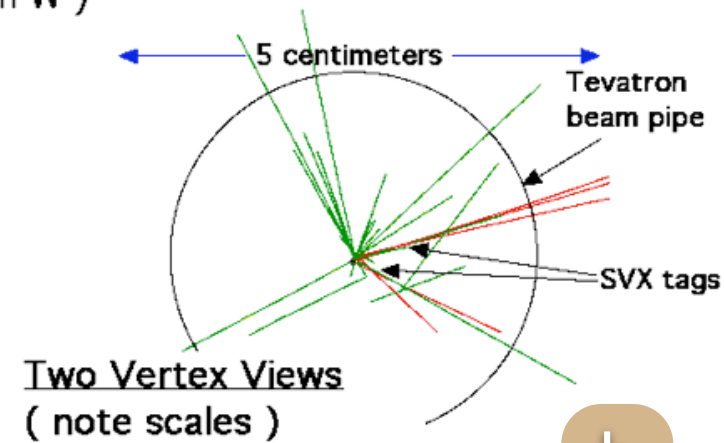
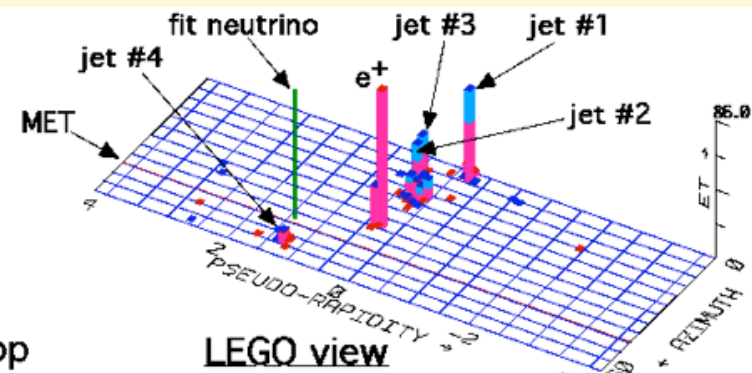
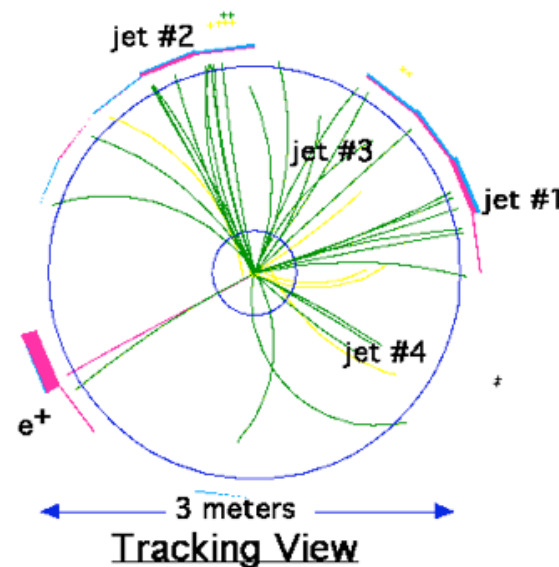

Decays and lifetimes

- If the couplings of a particle \mathbf{A} allow it to transform itself into a series of particles $\mathbf{B}_1, \dots, \mathbf{B}_n$, and if $m_{\mathbf{A}} > m_{\mathbf{B}_1} + \dots + m_{\mathbf{B}_n}$, \mathbf{A} decays into $\mathbf{B}_1 + \dots + \mathbf{B}_n$.

Only particles for which no decay channel is open can be stable. As of today, we only know of two such examples: electron and proton (although there are theories in which the proton is predicted to decay with a lifetime of about 10^{34} years, as well as theories in which stable heavy particles explain the origin of dark matter).

- Example:

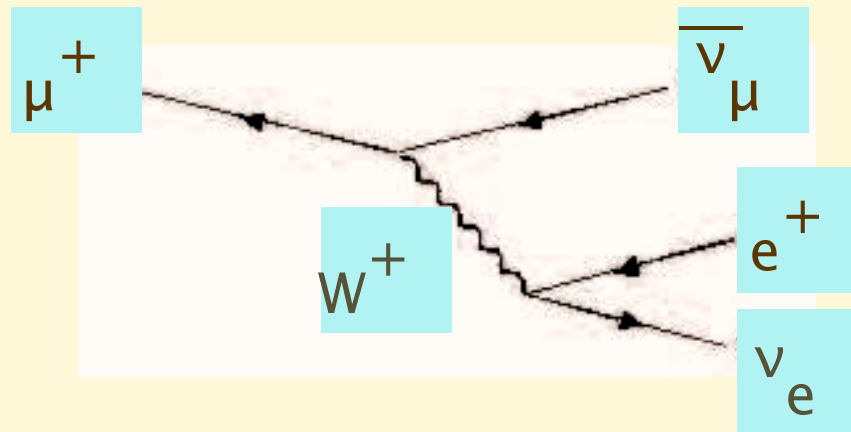

- The stronger the couplings, and the larger the mass difference, the faster the decay:

$$N(t) = N(0) e^{-t/\tau} \quad \text{where } \tau = \tau(M, g) \text{ is the **lifetime**}$$

Example: counting the number of neutrinos

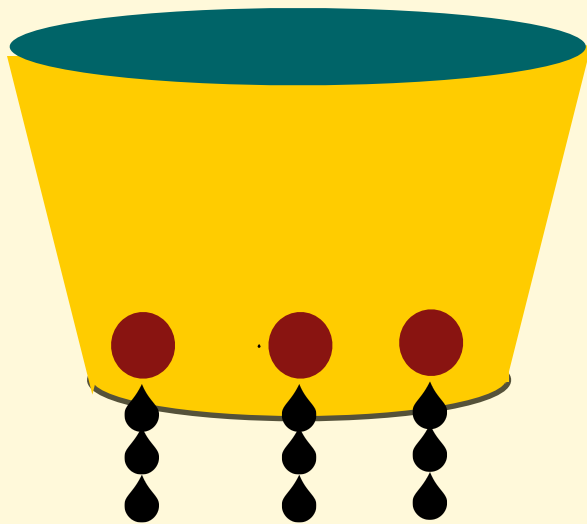

time to empty the bucket



particle lifetime

number of holes



number of decay channels

$\tau \propto 1/(\text{number of holes})$



$\tau \propto 1/(\text{number of decay channels})$

$\Gamma(Z) = \text{particle "width"} \propto \text{number of decay channels}$

NB: "Width" does not refer to a geometrical property of the particle, but to the shape of spectrum of the resonance (see later)

$$\Gamma(Z) = \sum_{q \setminus m_q < m_Z/2} \Gamma(Z \rightarrow q\bar{q}) + \sum_{\ell \setminus m_\ell < m_Z/2} \Gamma(Z \rightarrow \ell^+\ell^-) + \sum_{\nu \setminus m_\nu < m_Z/2} \Gamma(Z \rightarrow \nu\bar{\nu})$$

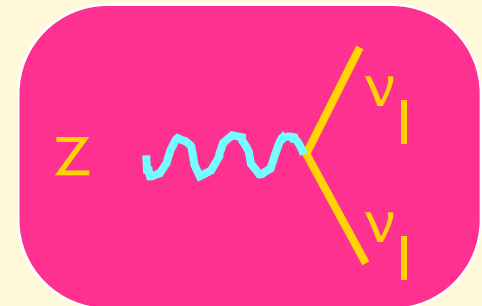

$$N_{\text{events}}(e^+e^- \rightarrow Z^0) \propto \left[(s - M_Z^2)^2 + M_Z^2 \Gamma_Z^2 \right]^{-1}$$

$$\sqrt{s} = \text{Energy}(e^+e^-)$$

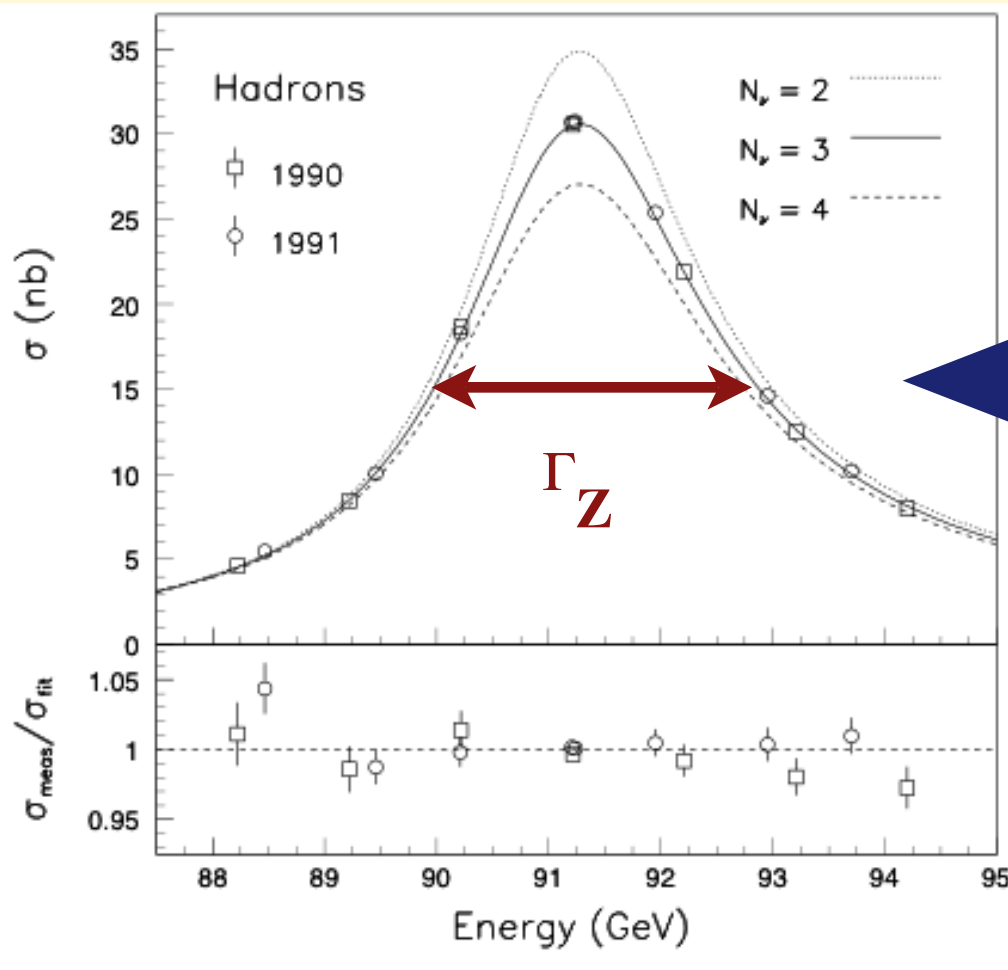

LEP $e^+e^- \rightarrow Z^0$ data, showing that the number of neutrino species $N_\nu = 3$

The measurement of a width can tell us something about what is not directly seen!

More in general, the measurement of a width will give us the strength of the coupling of the decaying particle to the decay products. The width (lifetime) itself is therefore not a fundamental property of a particle, but is a consequence of its mass and of its couplings.

The structure of the proton

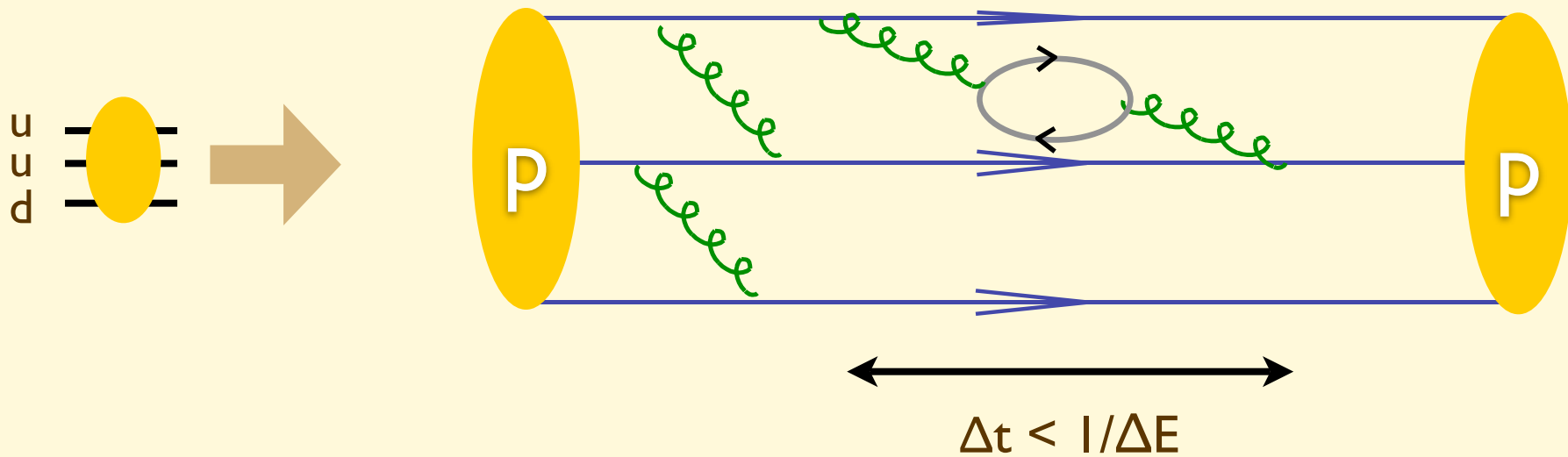

Inside the proton we can find, in addition to the component **uud** quarks, also **gluons** as well as **quark-antiquark** pairs

If we probe the proton at energies high enough, we take a picture of the proton with a very sharp time resolution, and we can “detect” the presence of these additional components. In particular, the **gluons** and **antiquarks** present inside will participate in the reactions involving proton.

Notice that, if Δt is small enough, even pairs of quark-antiquark belonging to the heavier generations (e.g. s-sbar, c-cbar) can appear!! The proton can contain quarks heavier than itself!!

Examples of reactions in proton collisions

quark-quark scattering:

Real-life example from p-pbar collisions at the Tevatron, 1.96 TeV CM energy:

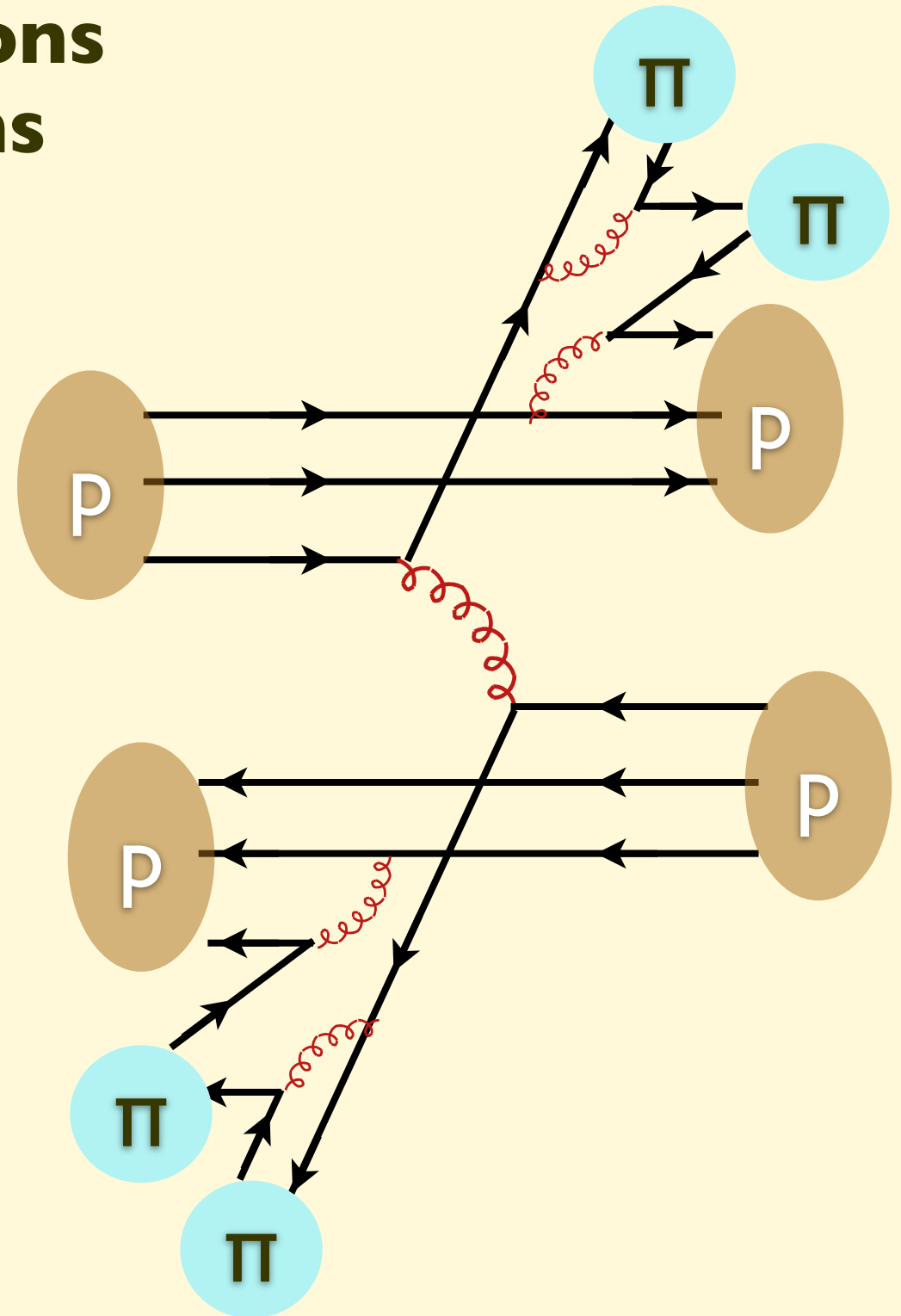
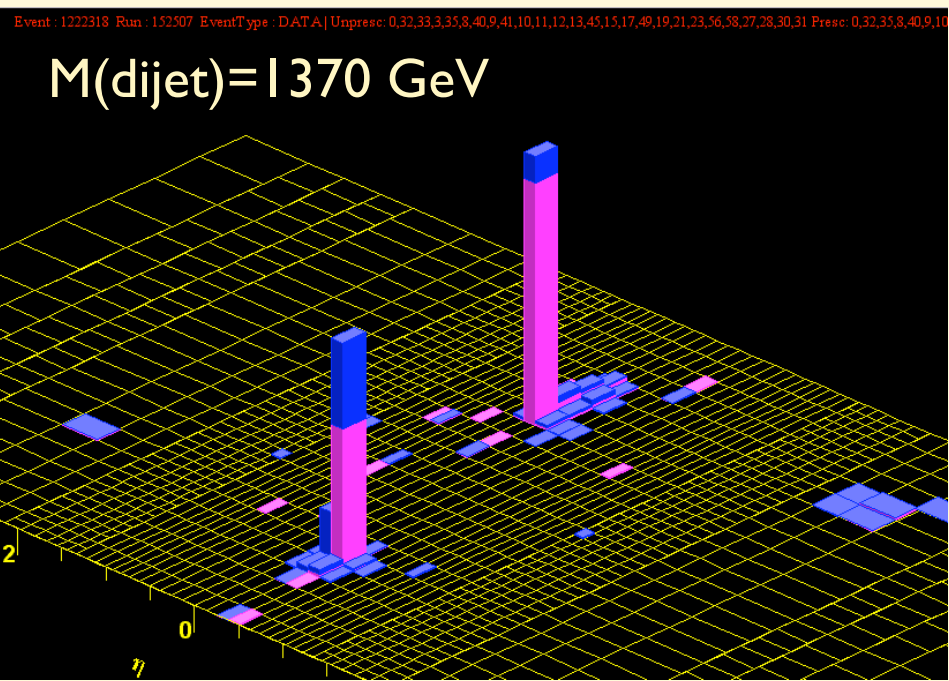

Real data (Tevatron) vs theoretical expectations

If quarks had a substructure apparent at a distance scale equal to $1/\Lambda$, this would lead to deviations from the theoretical curve

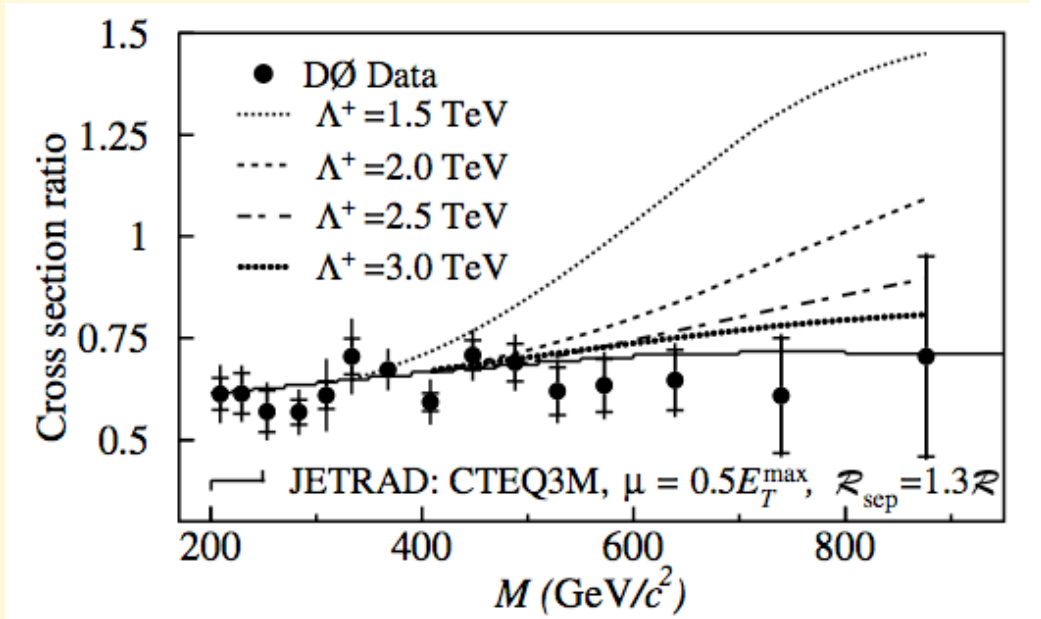
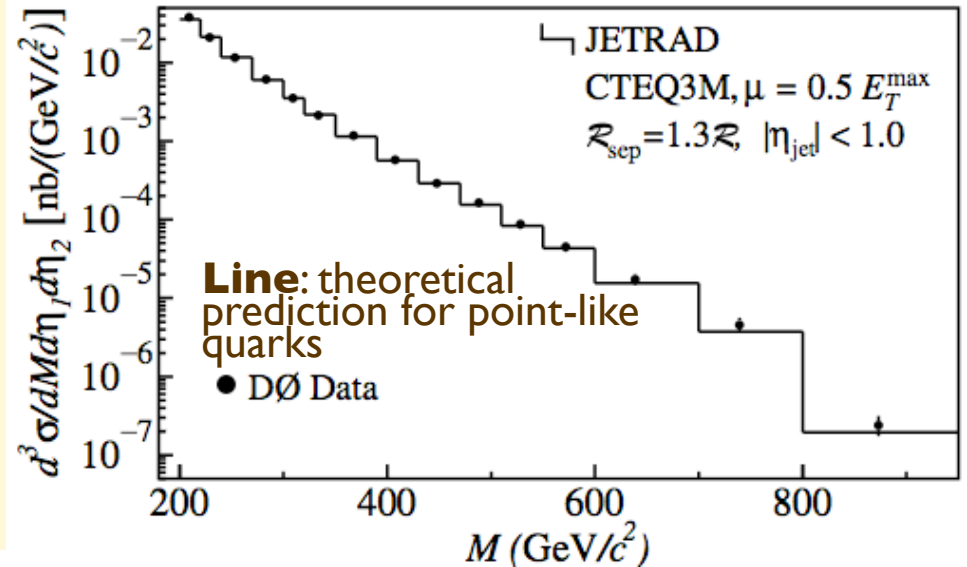

⇒ the data exclude $\Lambda < 2.4 \text{ TeV}$

Existing data prove that quarks are pointlike at least down to 10^{-17} cm

The LHC will probe distances a factor of 10 smaller!!

Examples of reactions in proton collisions

quark-antiquark annihilation:

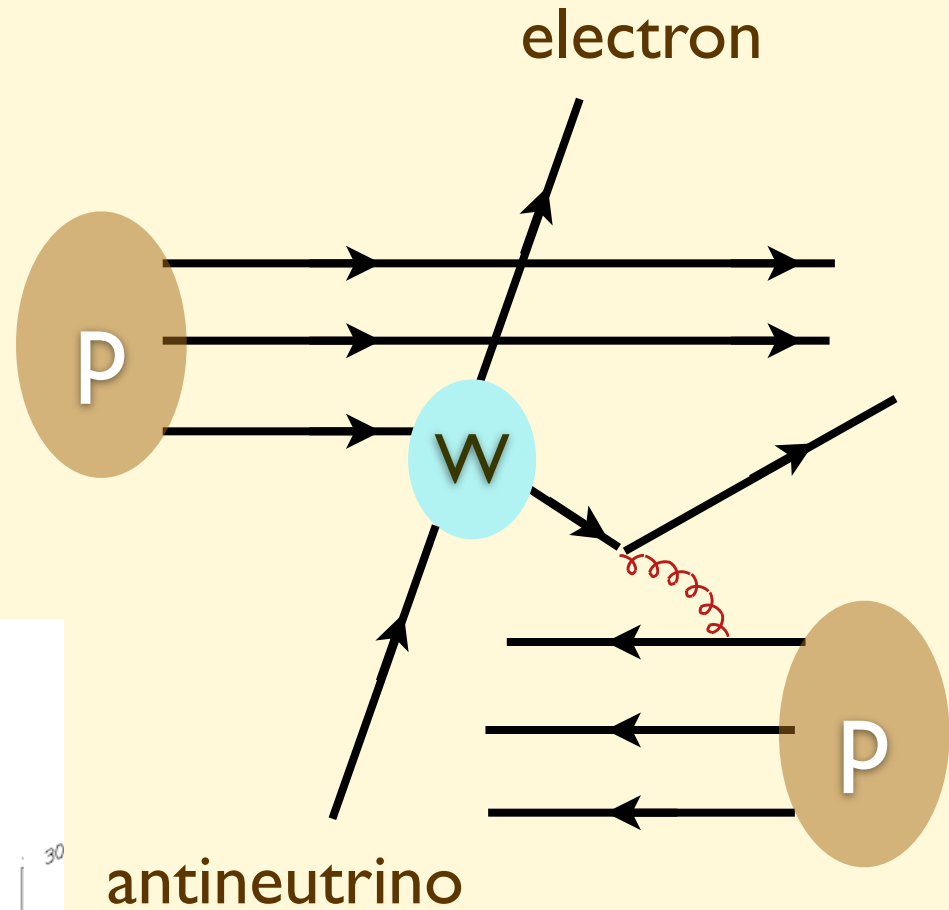

A real-life event from the tevatron:

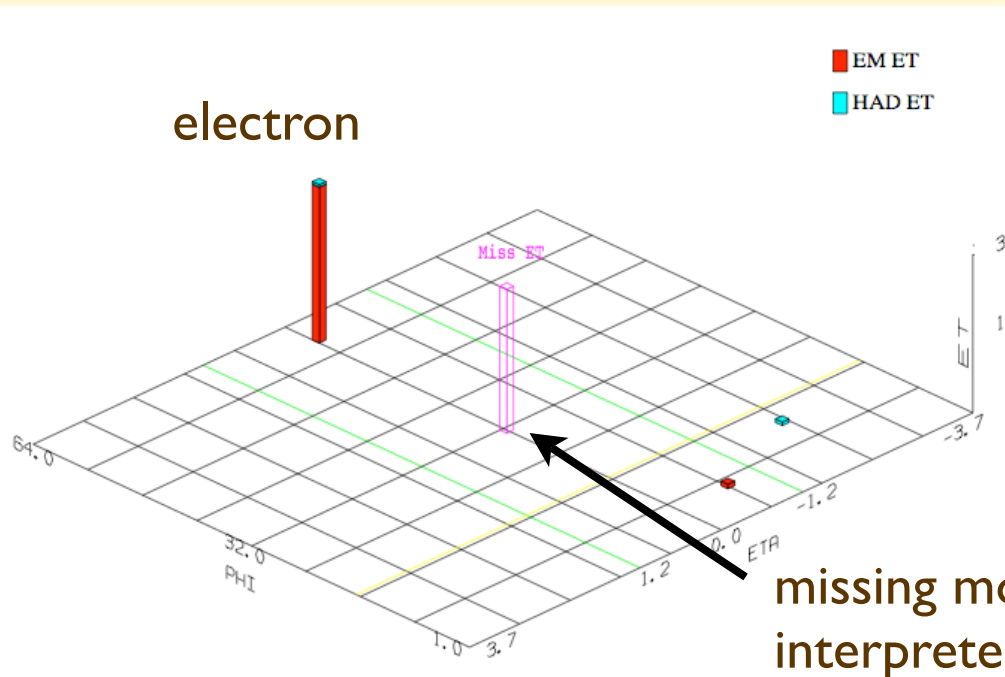

In principle the “force carrier” of new interactions could be created in the same way, provided their mass is not too large

Examples of reactions in proton collisions

gluon-gluon reactions:

$gg \rightarrow \text{top antitop}$

$e^+ + 4 \text{ jet event}$

40758_44414

24-September, 1992

TWO jets tagged by SVX

fit top mass is $170 \pm 10 \text{ GeV}$

e^+ , Missing E_T , jet #4 from top

jets 1,2,3 from top (2&3 from W)

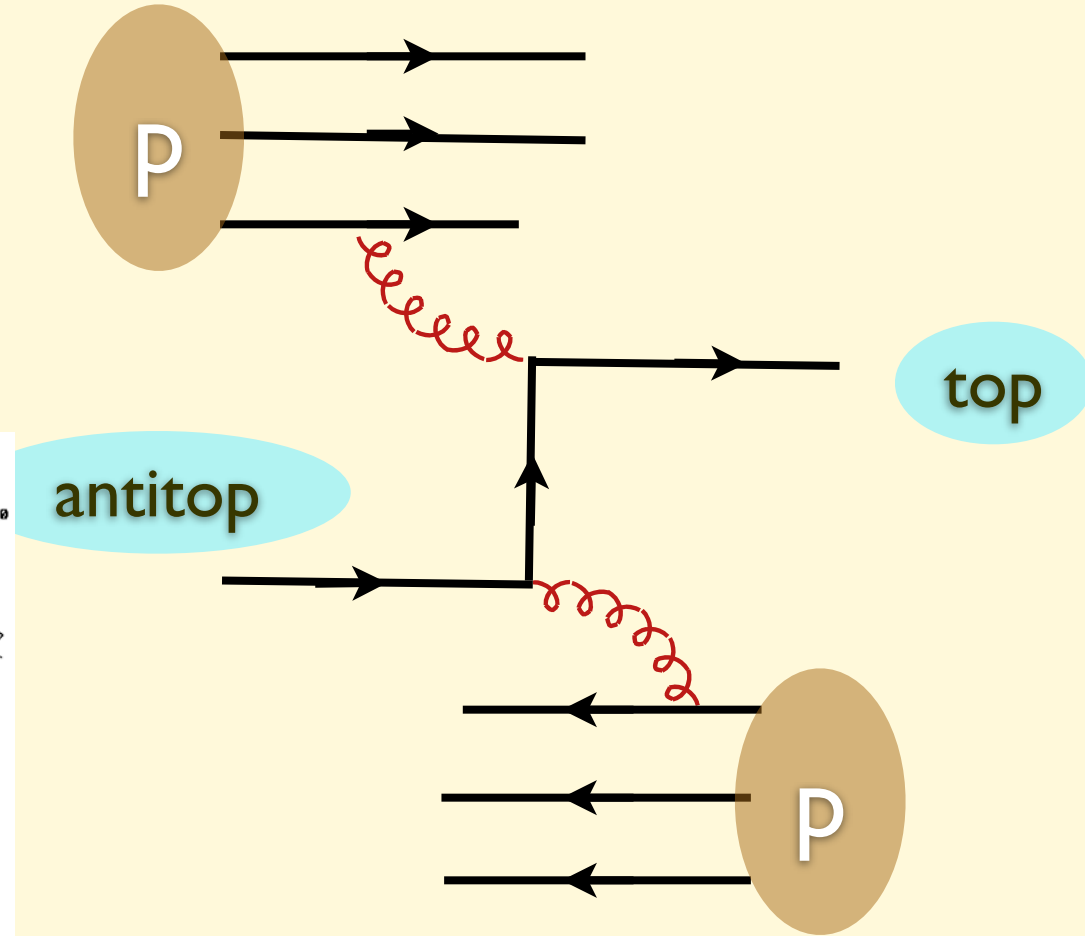
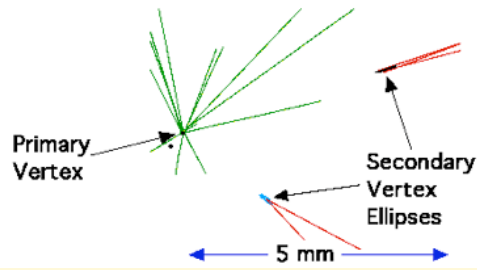
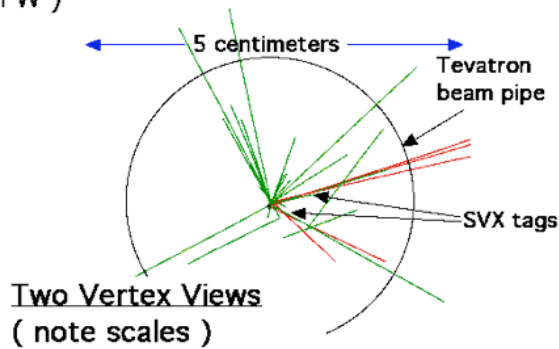
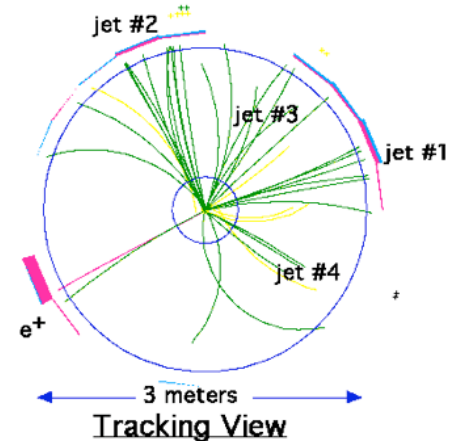
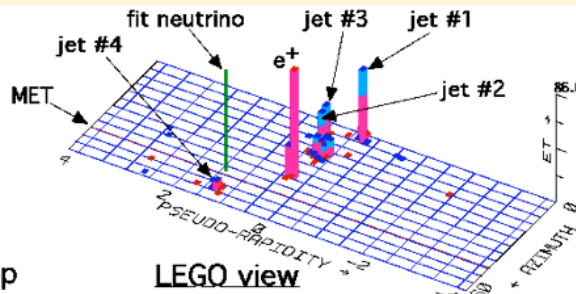

The Higgs and particles' masses

Light propagating in a medium is slowed down by its continuous interaction with the medium itself

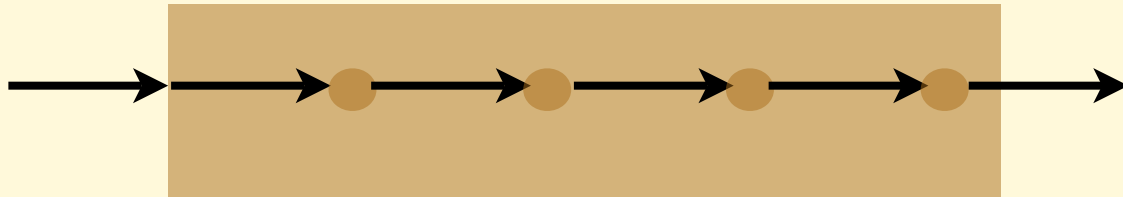

The time it takes to move across the medium is longer than if light were propagating in the vacuum,

$$\Rightarrow c_{\text{medium}} < c_{\text{vacuum}}$$

Think of the Higgs field as being a continuum medium embedding the whole Universe. Particles interacting with it will undergo a similar “slow-down” phenomenon. Rather than “slowing down”, however, the interaction with the Higgs medium gives them “inertia” \Rightarrow mass

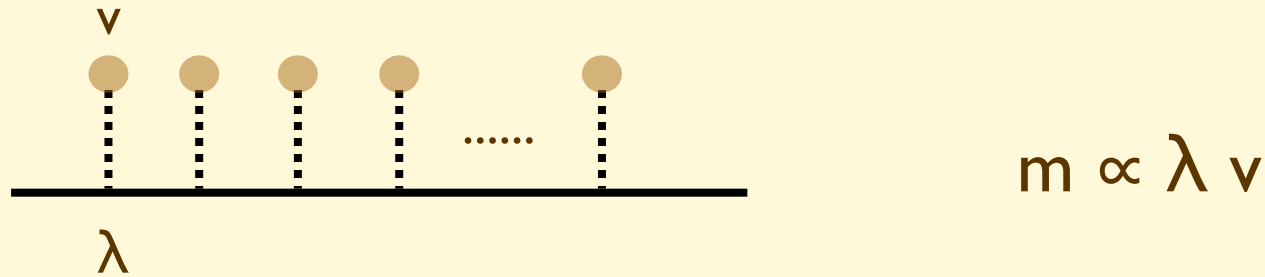

The number “ v ” is a universal property of the Higgs field background. The quantity “ λ ” is characteristic of the particle moving in the Higgs field. Particles which have large λ will have large mass, with $m \propto \lambda v$

Now the question of “why does a given particle has mass m ” is replaced by the question “why does a given particle couple with the Higgs field with strength $\lambda \propto m / v$ ”

However at least now we have a model to understand **how** particles acquire a mass.

Detecting the Higgs boson

Like any other medium, the Higgs continuum background can be perturbed. Similarly to what happens if we bang on a table, creating sound waves, if we “bang” on the Higgs background (something achieved by concentrating a lot of energy in a small volume) we can stimulate “Higgs waves”. These waves manifest themselves as particles* , the so-called Higgs bosons

What is required is that the energy available be larger than the Higgs mass \Rightarrow LHC !!!

* Even the sound waves in a solid are sometimes identified with “quasi-particles”, called “phonons”

Higgs interactions

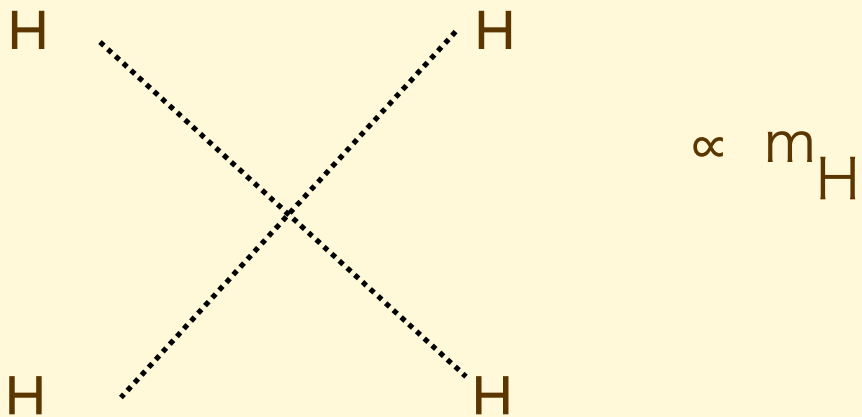
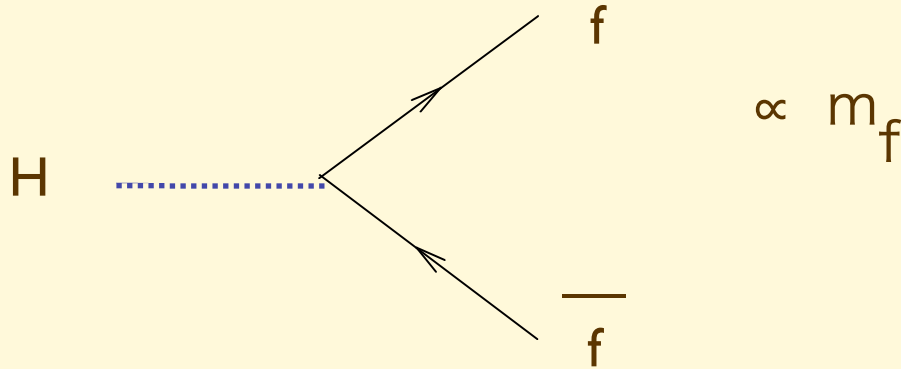
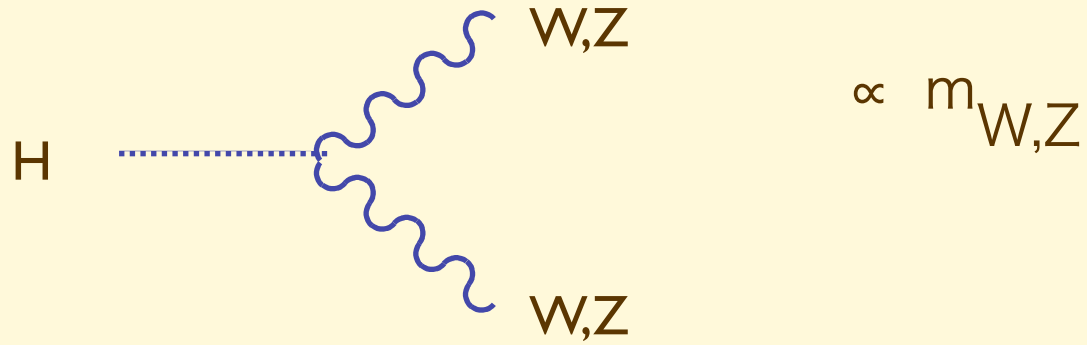

Four main production mechanisms at the LHC:

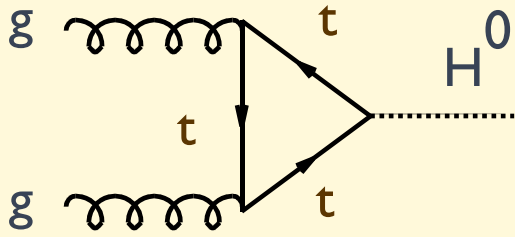

Gluon-gluon fusion (NNLO):

- Largest rate for all $m(H)$.
- Proportional to the top Yukawa coupling, y_t
- gg initial state

Vector-boson (W or Z) fusion (NLO):

- Second largest, and increasing rate at large $m(H)$.
- Proportional to the Higgs EW charge
- mostly ud initial state

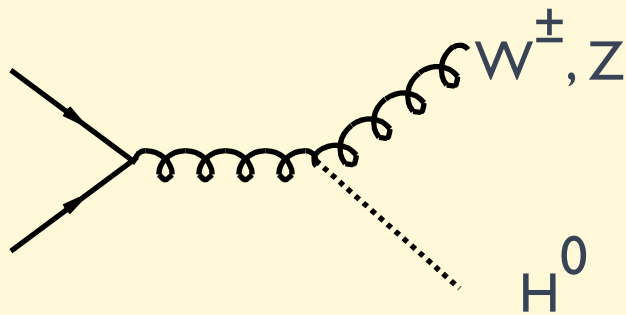
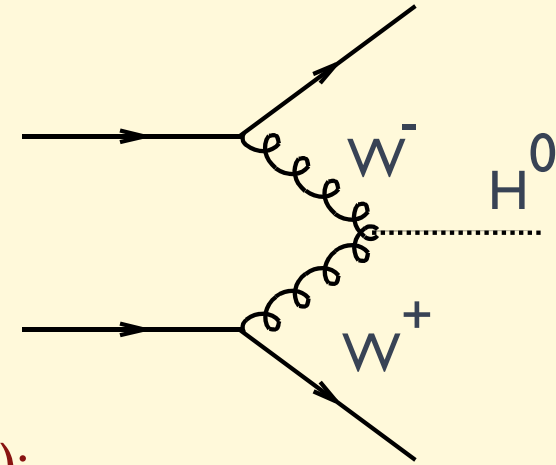

W(Z)-strahlung (NNLO):

- Same couplings as in VB fusion
- Different partonic luminosity (uniquely qqbar initial state)

ttH/bbH associate production (NLO):

- Proportional to the heavy quark Yukawa coupling, y_Q , dominated by ttH, except in 2-Higgs models, such as SUSY, where b-coupling enhanced by the ratio of the two Higgs expectations values, $\tan\beta^2$

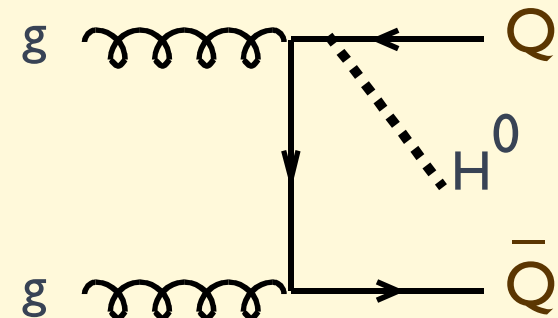

- Same partonic luminosity as in gg-fusion, except for different x-range

Higgs production rates at the LHC

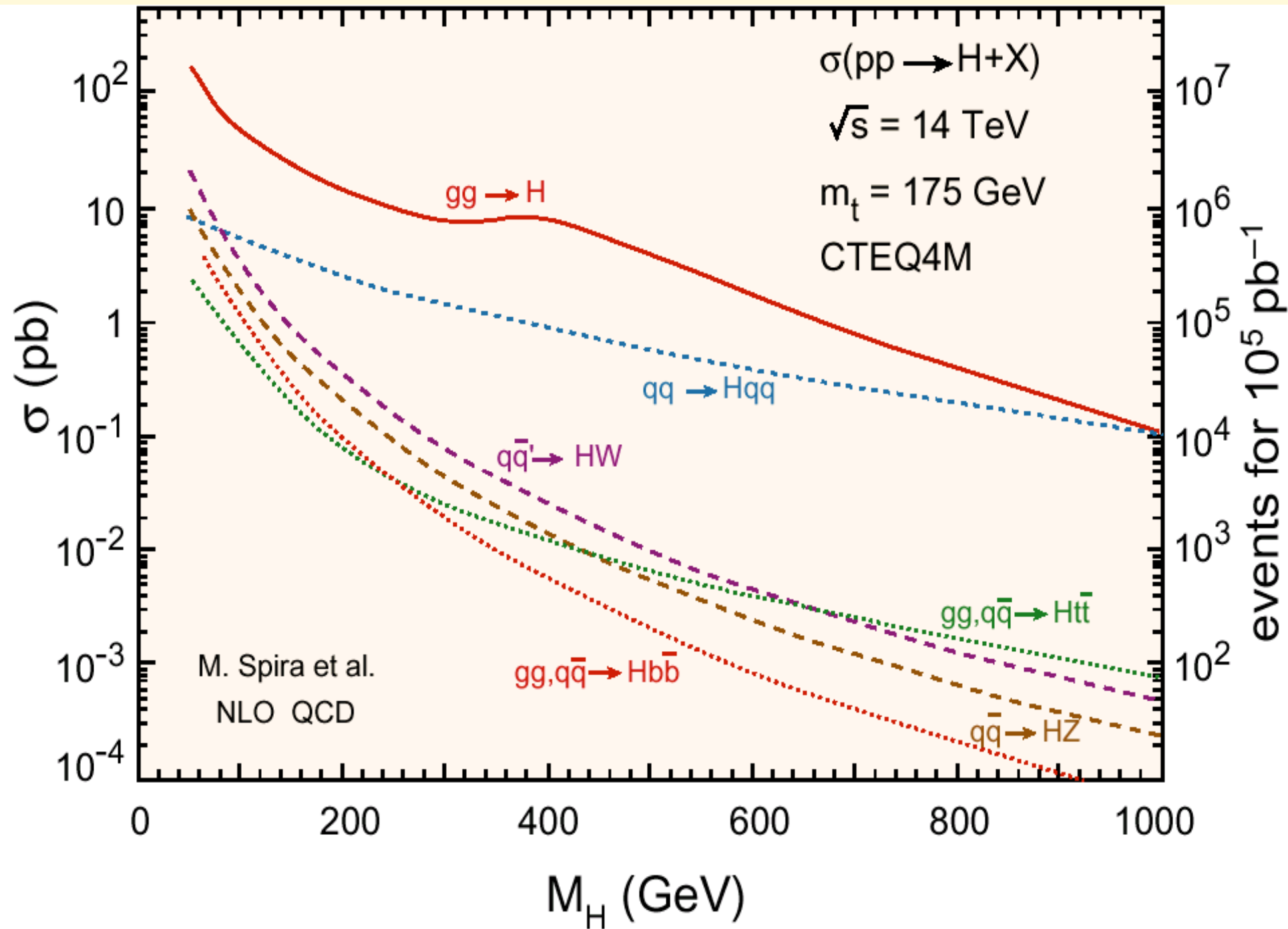

Higgs decays

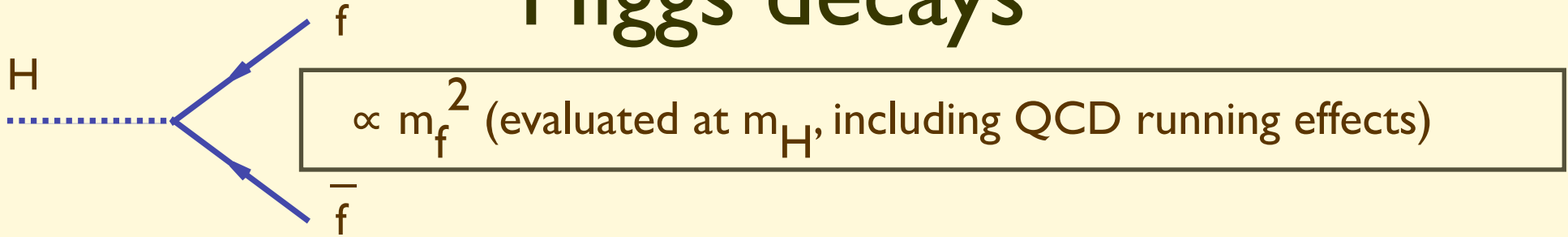

$\propto m_f^2$ (dominated by top-quark loops)

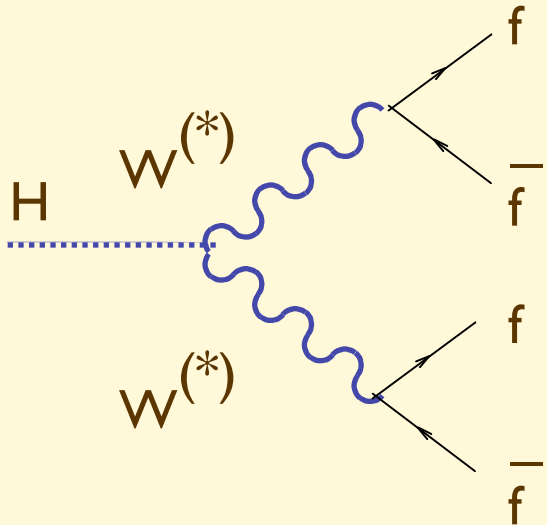
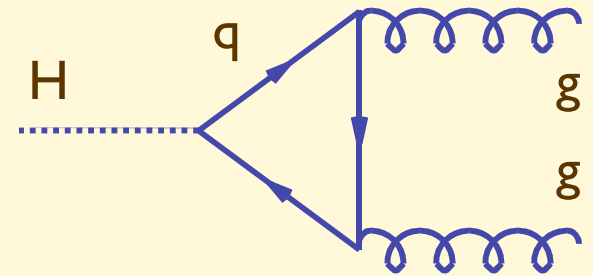

$\propto \alpha_W$ (sharp threshold at $m_H = 2m_W$, but large BR even down to 130 GeV). Similar processes with $W \leftrightarrow Z$.

Dominated by the EW couplings, only minor contribution from top loop $m \Rightarrow$ correlated to $H \rightarrow WW$

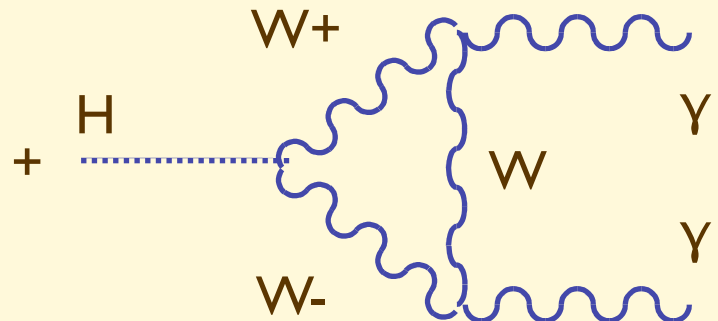
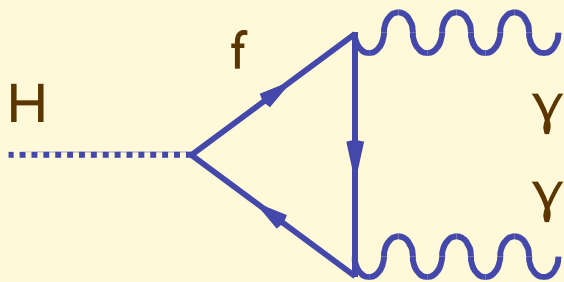

Higgs decays

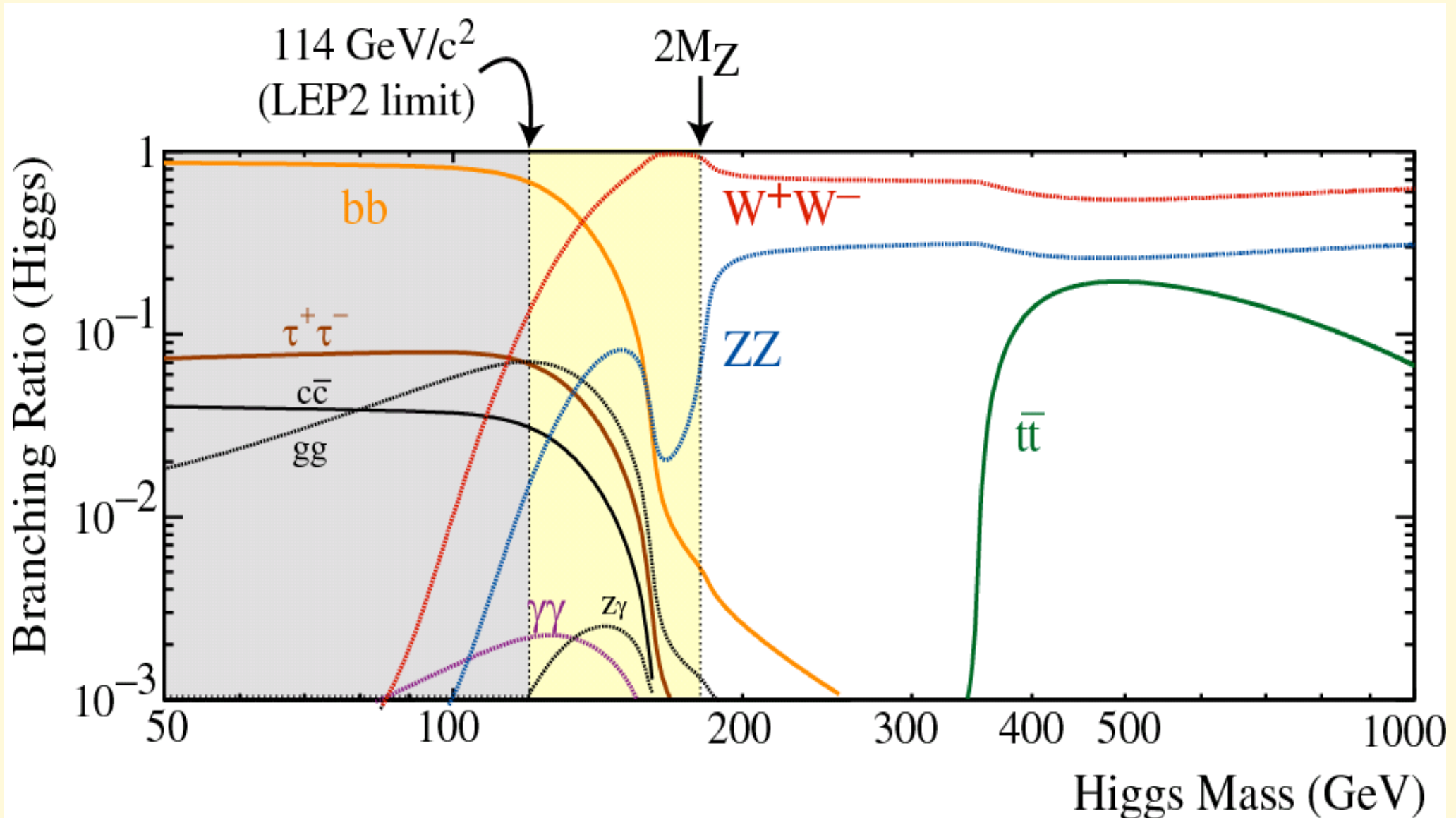

Not all decay modes are accessible at a given mass. Very high luminosity is required to thoroughly investigate the Higgs couplings

How can we detect the Higgs?

Example: If $m(H) > 2 m(Z) \Rightarrow H \rightarrow ZZ$

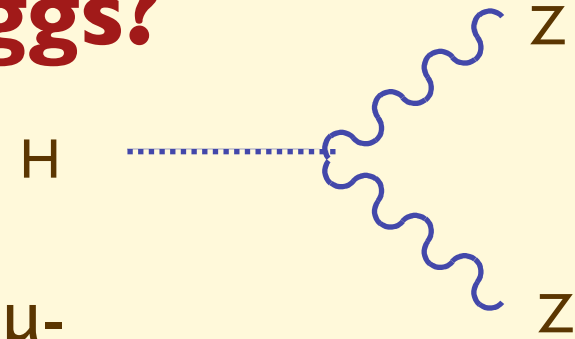

Each Z will decay. Assume for example $Z \rightarrow \mu^+ \mu^-$

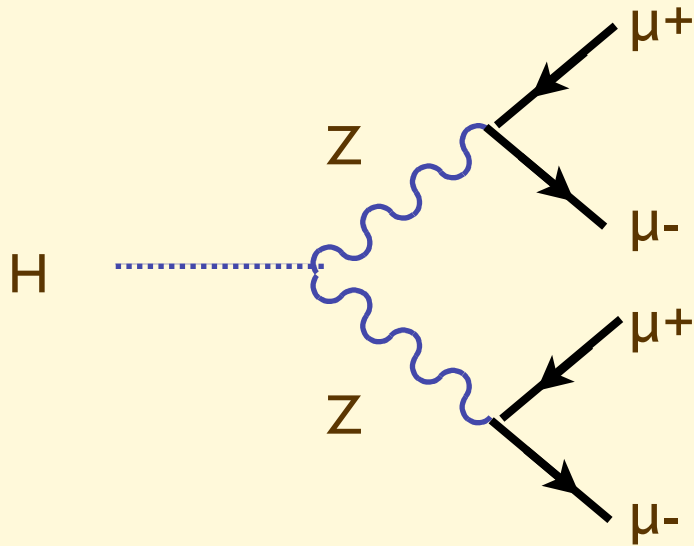

A computer simulation of how the signal will appear, for $m_H = 200$ GeV

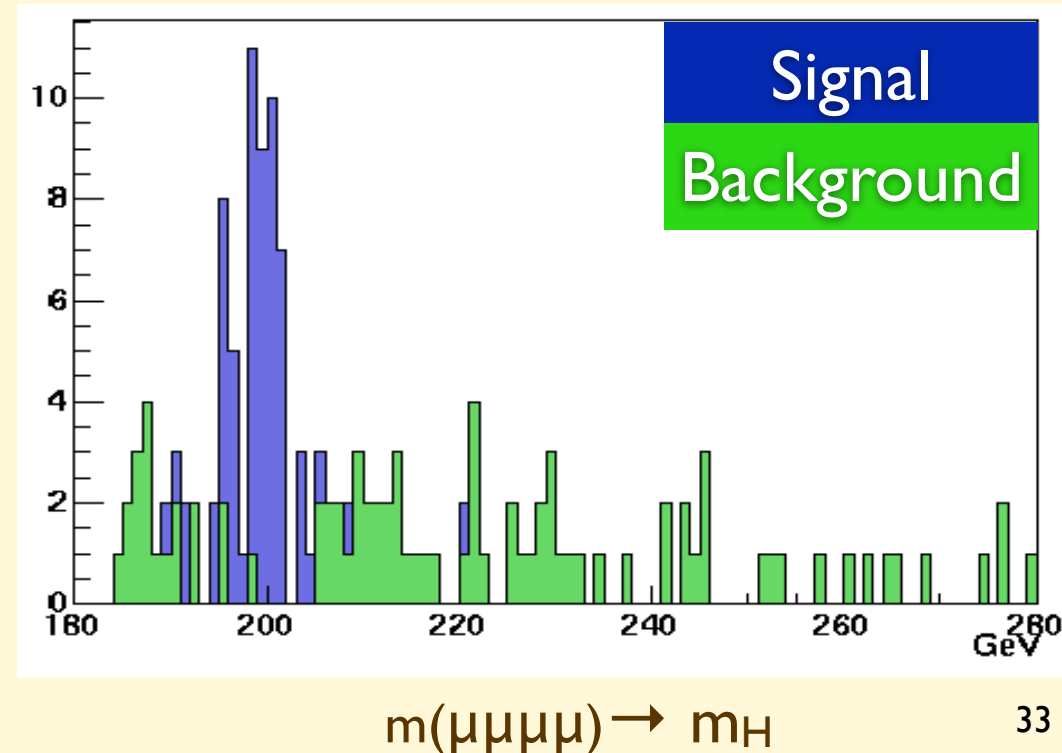

Search for events with 4 muons ($\mu^+_1 \mu^-_2 \mu^+_3 \mu^-_4$) subject to the condition that:

$$m(\mu^+_1 \mu^-_2) = m(\mu^+_3 \mu^-_4) = m(Z)$$

The invariant mass of the 4-muon system will then give $m(H)$

$H(150\text{GeV}) \rightarrow Z^0 Z^{0*} \rightarrow 4\mu$ (event 10)

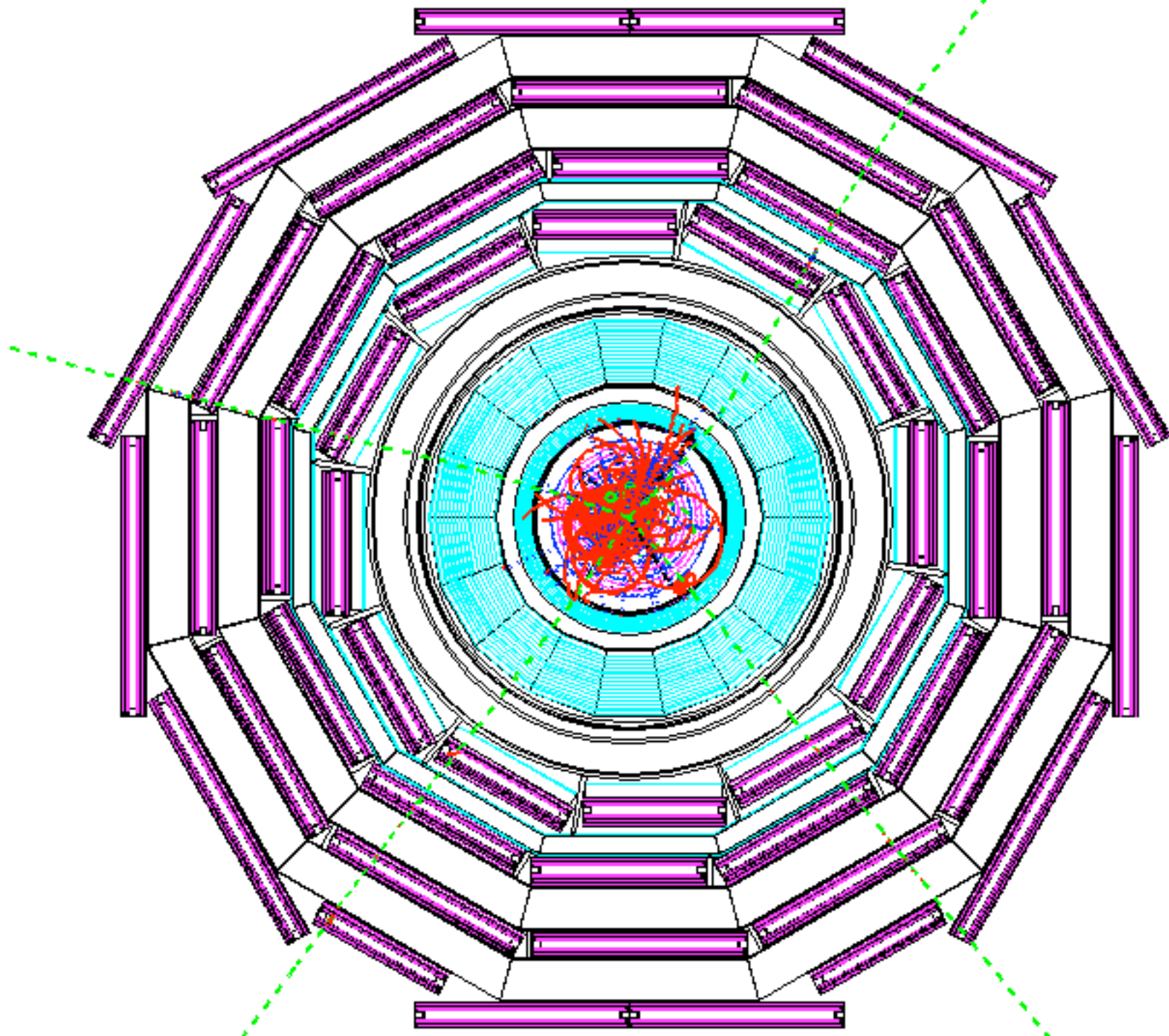

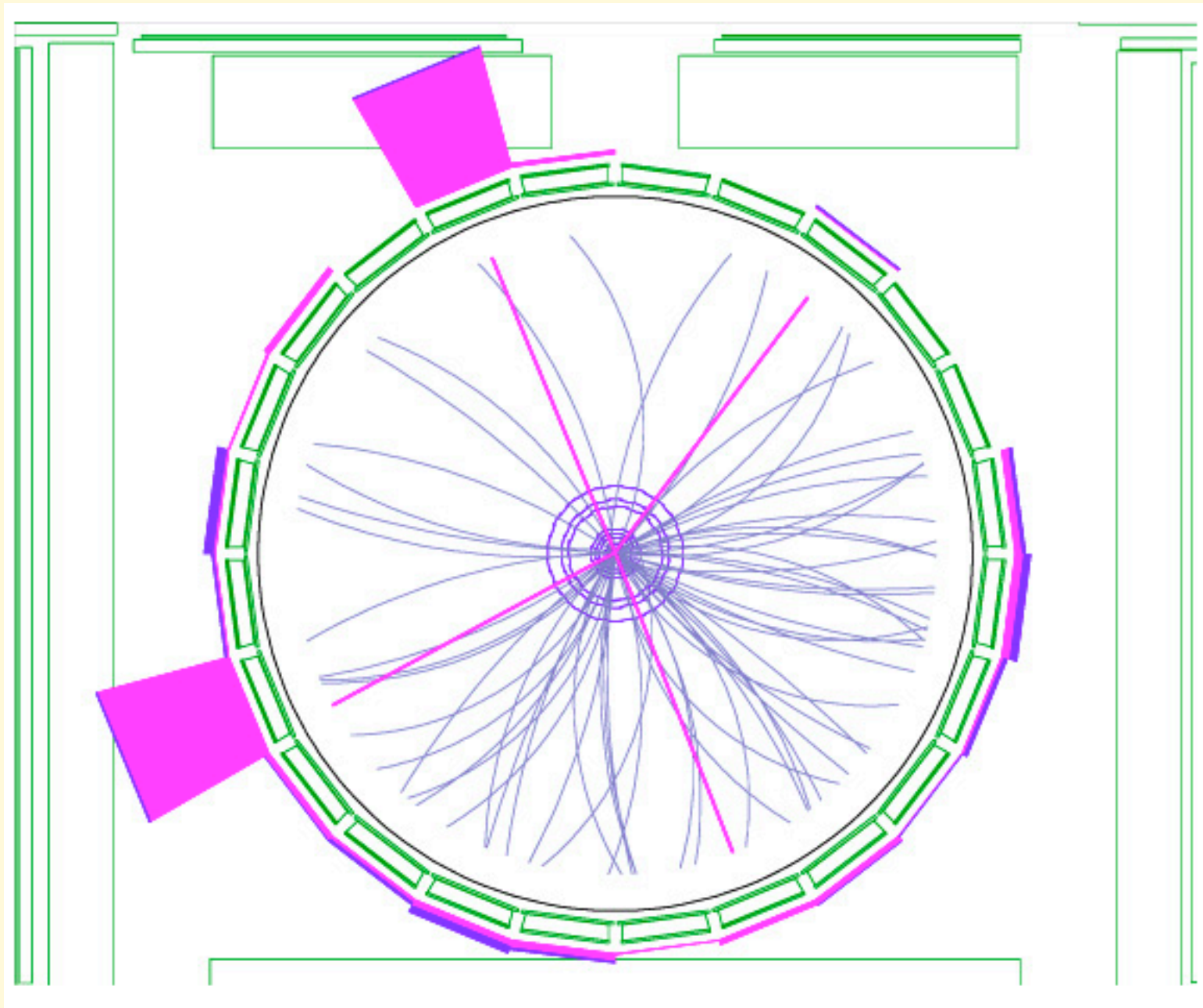

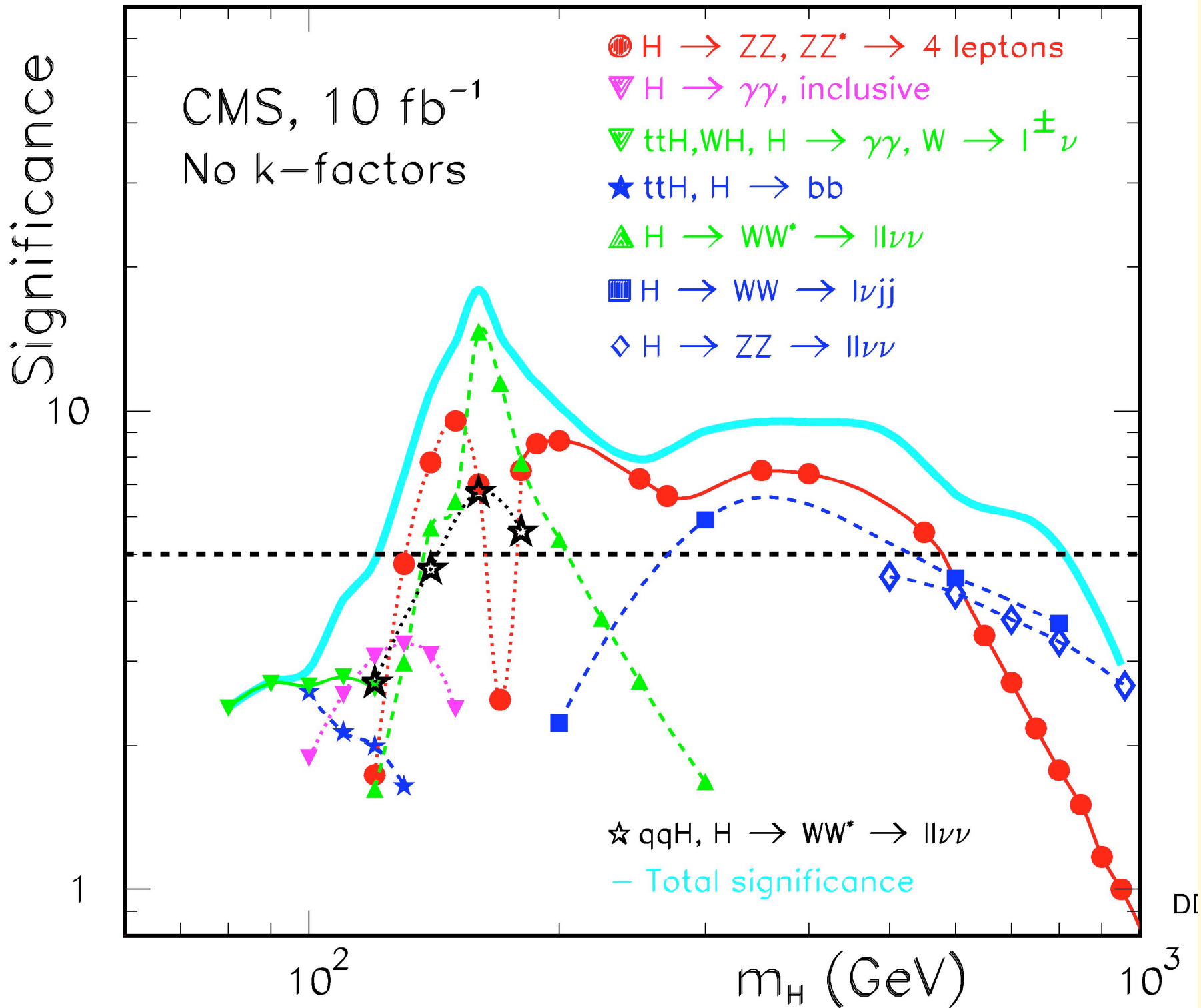

Supersymmetry signals at the LHC

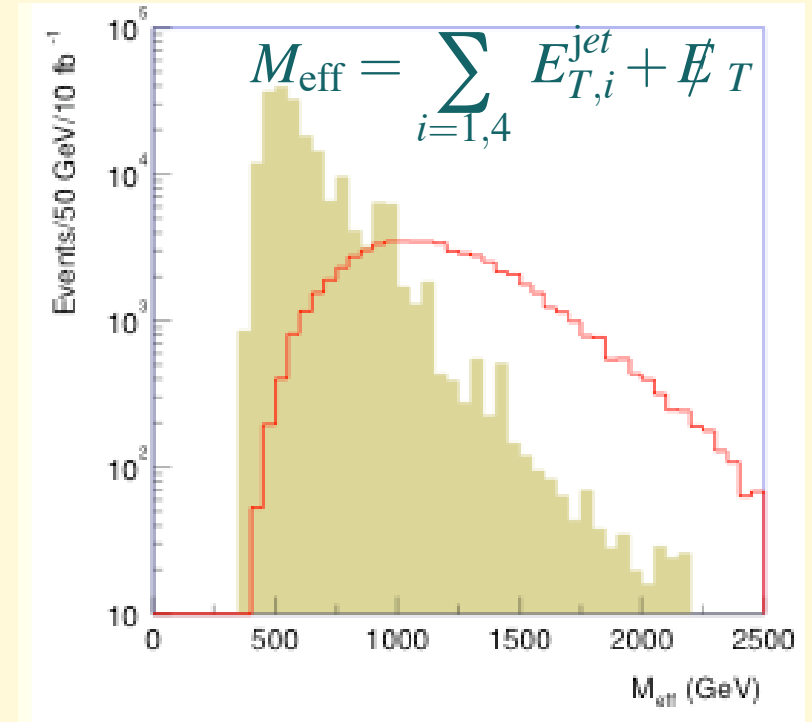
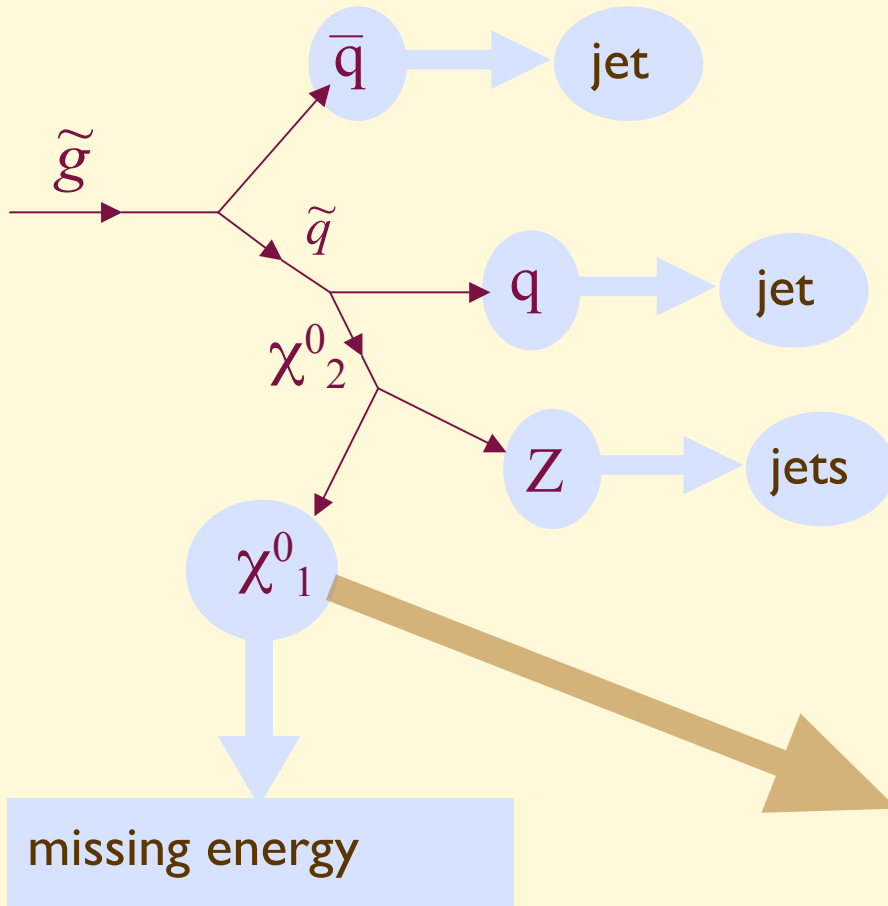
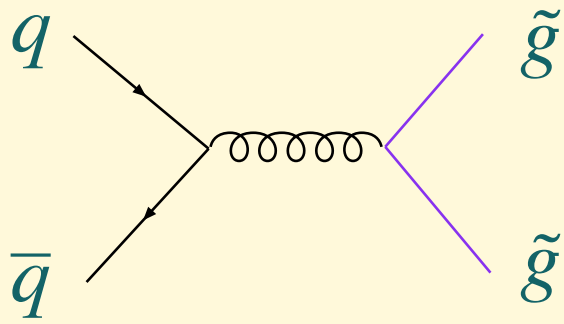

dark matter candidate

Summary of LHC physics potential

- **Discover the Higgs boson**
 - Determine to 10-20% the value of several of its couplings
- **Quark substructure:**
 - Push the limits on the “size” of the u/d quarks down by more than one order of magnitude w.r.t. today
- **Weak interactions at TeV scale:**
 - Test existence of **new gauge interactions**, e.g. right-handed W bosons, extra U(1)'s (as present in string theories), etc.
- **Discover Supersymmetry and possibly dark matter**
 - Provide first key measurements of the parameters of Supersymmetry
- **Collect further evidence for a grand unification of the fundamental interactions at a scale of 10^{15} GeV**

