

Trigger Introduction



- **Status of the CMS Trigger Upgrade Activities:**
 - uTCA and Optical Link upgrades
 - Simulations of new calorimeter trigger algorithms
- **Goals for the trigger WG which meets this afternoon:**
 - Organize a comprehensive study which will evaluate the physics benefits from upgrading the current system for Phase-I
 - Review the progress on hardware developments (uTCA) and make plans for future designs.
 - Discuss and form a plan for introducing a uTCA system already during LHC to gain experience and confidence.
 - Make the first roadmap for commissioning the new system.

Progress since May 08



- Starting after the May 08 workshop a number of groups were formed within the Trigger Upgrade Group focusing on the following topics:
 - **Simulation studies for Phase-I triggers (Calorimeter/Muon). The studies done so far refer to improvements in:**
 - Tau Triggers (Texas A&M, Wisconsin)
 - Electron and Jet Triggers plus general clustering algorithms (Wisconsin)
 - **Simulation studies for Tracking Triggers.**
 - Track Trigger group and Simulation group have:
 - used the Stacked Tracker model developed by the Tracker Upgrades group.
 - started developing the trigger software framework (TPG) which is the starting point for trigger studies.
 - **uTCA demonstrator hardware.**
 - A number of uTCA devices are at various stages of development:
 - HCAL prototype card (J. Manns, Minnesota)
 - GCT Matrix System (CERN, Imperial, LANL, Princeton)
 - uTCA TTC/SLINK64 Card (Wisconsin)

Trigger Upgrades Organization

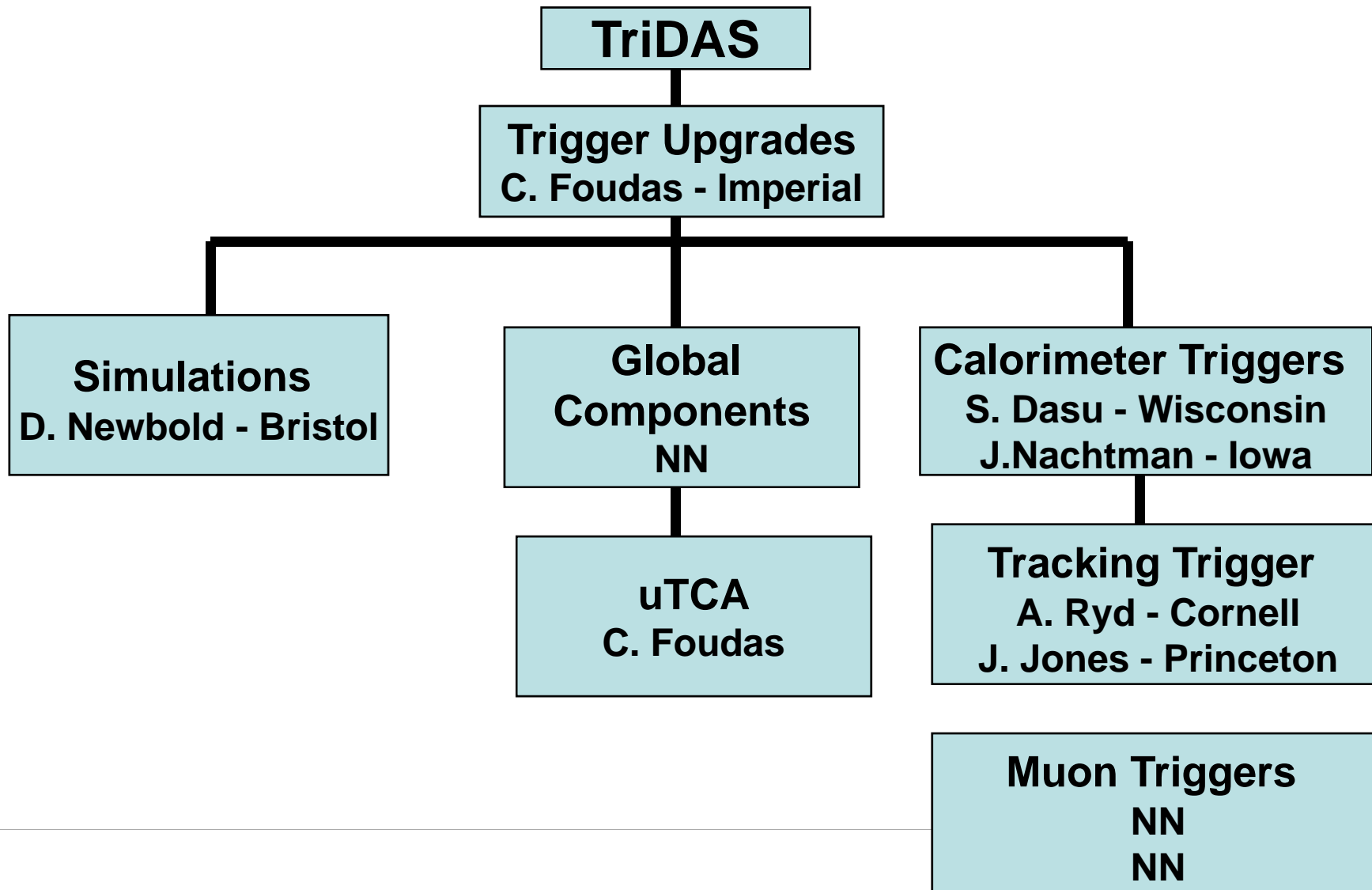

uTCA Systems for SLHC Phase-I Triggering

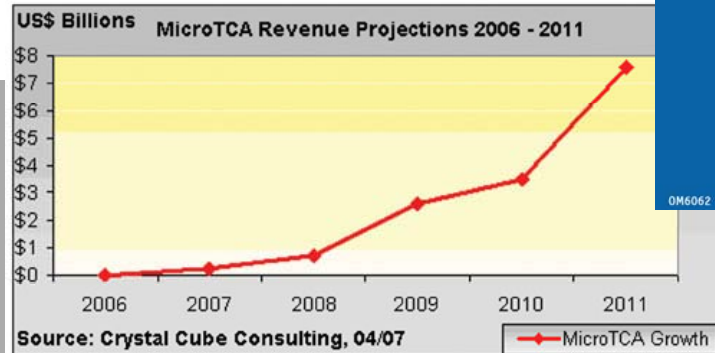
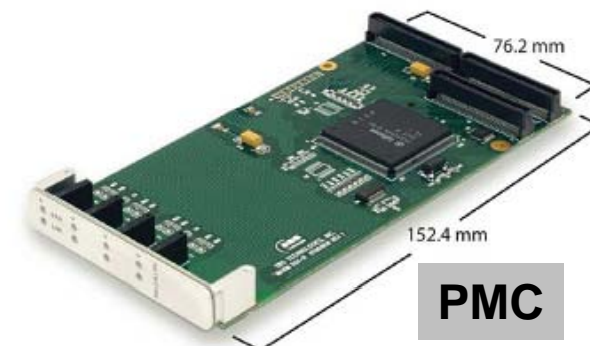
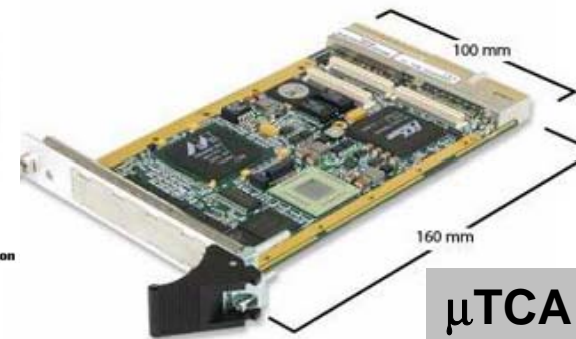

- The μ TCA system under development for the GCT Muon/Quit Bits.
- Changes for Lvl-1 Trigger in SLHC Phase-I
- uTCA developments within CMS

The uTCA Standard for Triggering

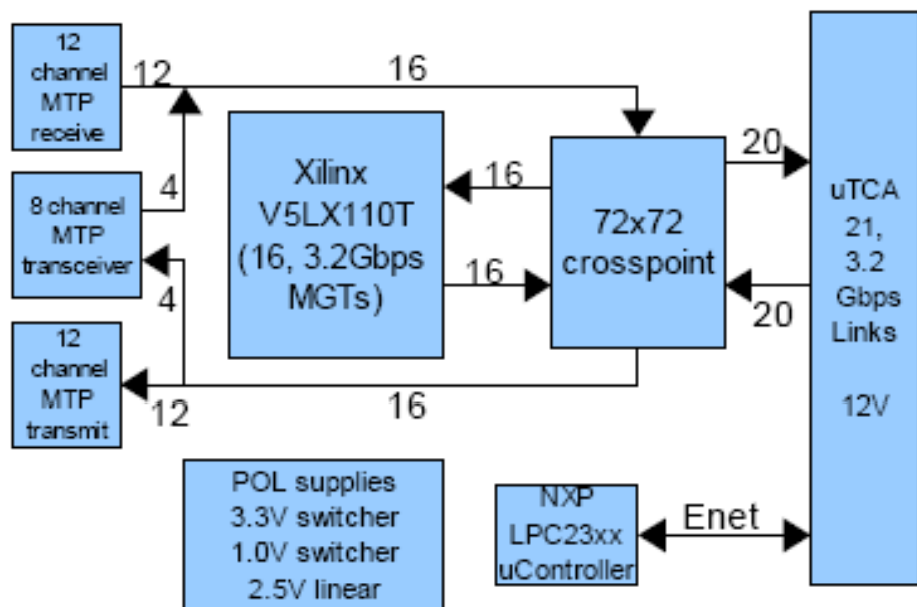

We are about to start to develop a uTCA system utilizing 3.2 GBps links which will consists of:

- A main uTCA processing card.
- A custom backplane.

- A standard trigger platform based on the uTCA telecom Standard.
- This platform will be designed to accept data from different detectors and support a Lv1 tracking trigger.
- We wish to investigate the question whether this platform can replace all Lv1 trigger off detector electronics and become a CMS-wide standard.**
- This would reduce significantly manpower and R&D costs

Phase-I Issues



- **The entire Calorimeter Trigger electronics will change for Phase-I and the new platform will be based in uTCA. There are several reason for this:**
 - Increase the trigger granularity and base all the algorithms on trigger towers rather than 4x4 trigger tower regions. This will benefit:
 - Tau triggers
 - Central Jet triggers in terms of rapidity and phi resolution
 - Forward trigger
 - HCAL electronics will change regardless. This will trigger upgrades in:
 - Trigger (RCT,GCT,GT)
 - ECAL SLB will need to be optical
- **The question is how do you bring the new system (and remove the old one) in a safe and smooth way. This will be discussed today.**
- **Groups actively contributing: Imperial, Maryland, Minnesota, Princeton, Texas A&M, Wisconsin. Several others have expressed interest.**

μ TCA Cards already in CMS



The Minnesota Card (J. Manns)

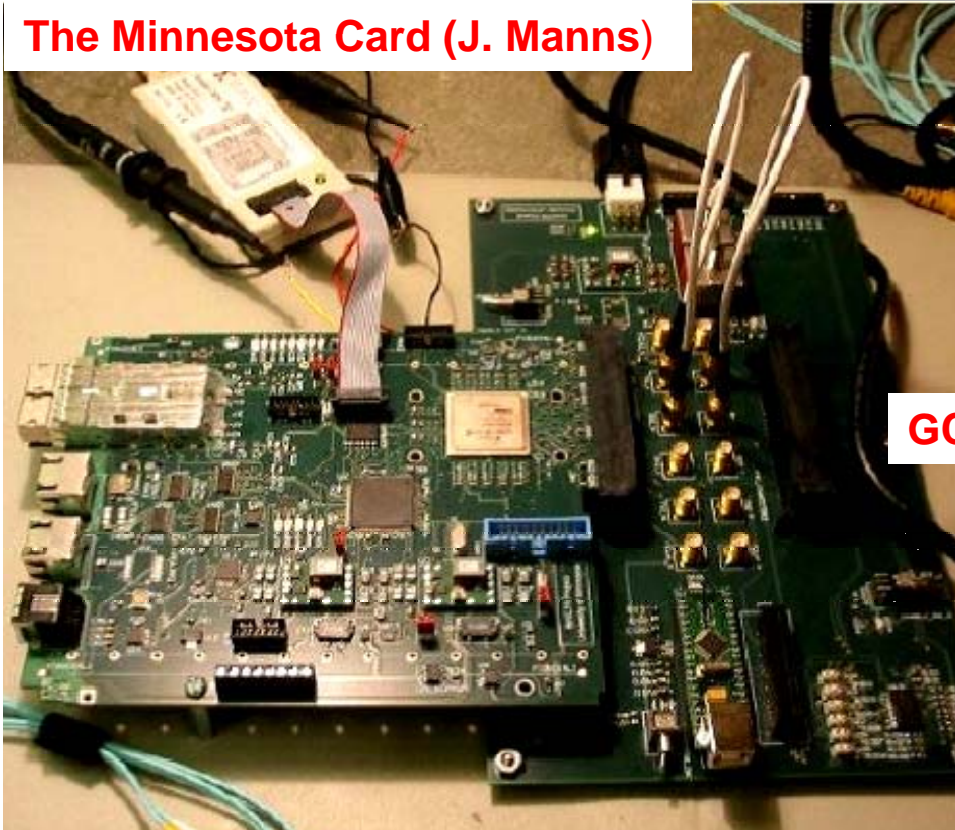

GCT Matrix Card

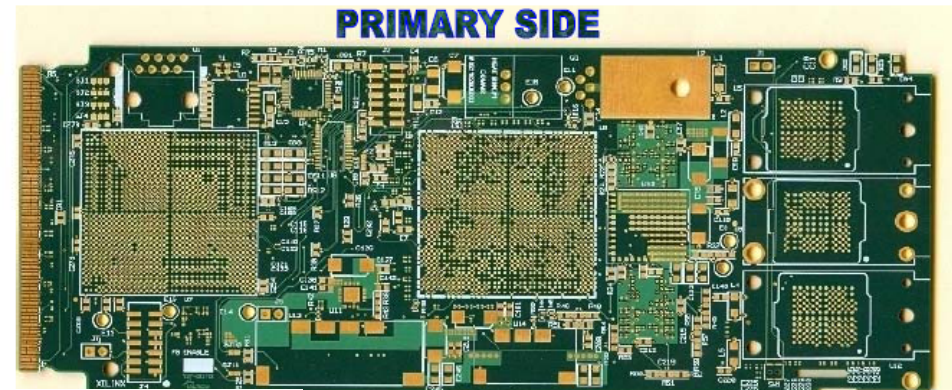

SECONDARY SIDE

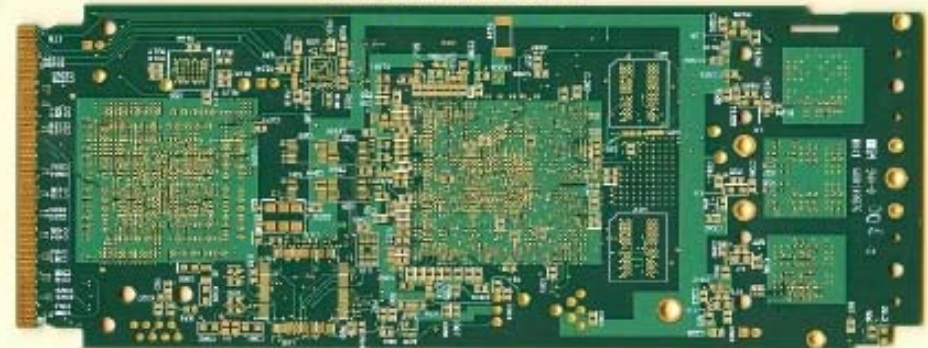

- The Minnesota Card: Evaluate μ TCA and Multi GBps optical link technology and then use it for HCAL and CaloTrigger Upgrades.
- The GCT Matrix Card +Backplane: Full blown system for triggering; Hope to use LHC data to demonstrate sophisticated algorithm performance.
- Under development: μ TCA card with S-link and TTC interface (Wisconsin)
Optical interface between GT-GCT (Imperial Vienna)

Opto-GTI: GCT-to-GT Optical Links

- The Interface between GCT and GT is changing from InfiniBand to Optical.
- The Links are compatible with those used by GCT and the GCT uTCA Matrix system.
- This change will be introduced before the LHC data taking to:
 - Improve link reliability
 - Double the GCT-to-GT bandwidth.
- This also means that the new GCT uTCA crate can communicate directly with GT.

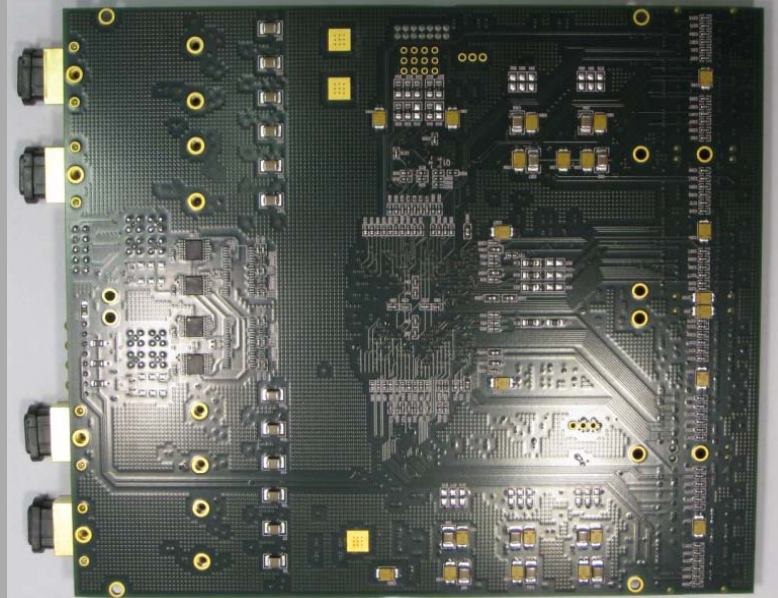
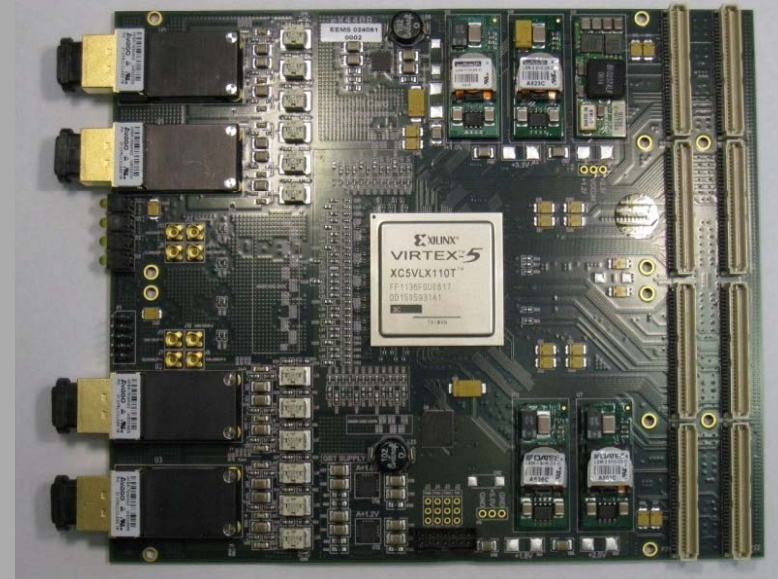

Plan for this afternoon



- **Calorimeter Trigger Studies:**
 - New Results from the Texas and Wisconsin Groups
 - Plan to complete the various studies by early spring 08
- **uTCA hardware demonstrators:**
 - Status of the various uTCA devices.
 - Preliminary results on Cal. Trigg. Algorithms on Xilinx V5 FPGAs.
 - Sketch plans for future designs and collaborative efforts.
- **uTCA upgrades during LHC data taking:**
 - Make a plan for introducing the first uTCA crates during LHC data taking without disrupting data taking.
- **Testing and Commissioning of a new uTCA-based trigger system from CMS:**
 - Involves detailed testing of the new system in an integration facility
- **Road map for Phase-I Upgrades:**
 - Develop a design and plan that also can accept tracking trigger TPGs.

END



**Looking forward to a
productive workshop...**