

Low Energy SPL Superbeam

Simone Gilardoni
CERN – AB/ABP

Simone.Gilardoni@cern.ch

Contributions from: M. Mezzetto, M. Donega, V. Palladino,
A. Cazes, J. E. Campagne, A. Fabich, A. Blondel et al.

Example of **conventional neutrino beam**: WANF

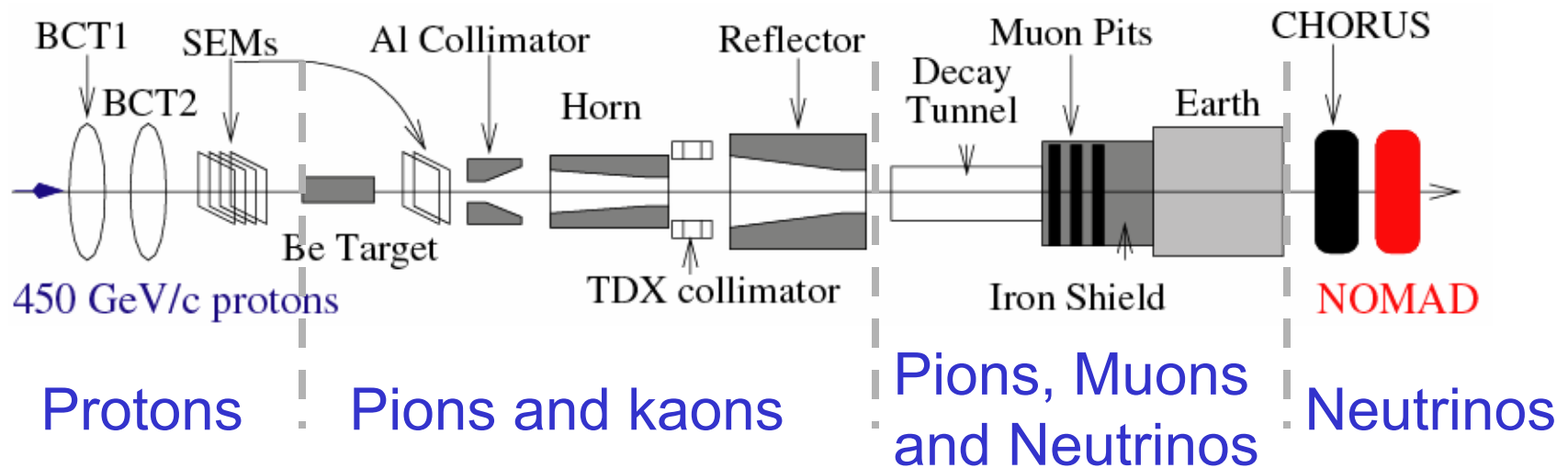

Superbeam basic ingredients: **Multi-MegaWatt proton** source to produce a high intensity neutrino beam directed to a **Multi-100 kTon neutrino detector**.

Aim: Study the the oscillation of $\nu_{\mu} \rightarrow \nu_{e}$ to get θ_{13} and possibly to have a first hint of leptonic CP violation with a LBL experiment



Neutrino's beam future



From: Takashi Kobayashi, Paris 2004

	E_p (GeV)	Power (MW)	Beam	$\langle E_\nu \rangle$ (GeV)	L (km)	M_{det} (kt)	ν_μ CC (/yr)	ν_e @peak
K2K	12	0.005	WB	1.3	250	22.5	~50	~1%
MINOS(LE)	120	0.4	WB	3.5	730	5.4	~2,500	1.2%
CNGS	400	0.3	WB	18	732	~2	~5,000	0.8%
T2K-I	50	0.75	OA	0.7	295	22.5	~3,000	0.2%
NOvA	120	0.4	OA	~2	810?	50	~4,600	0.3%
C2GT	400	0.3	OA	0.8	~1200	1,000?	~5,000	0.2%
T2K-II	50	4	OA	0.7	295	~500	~360,000	0.2%
NOvA+PD	120	2	OA	~2	810?	50?	~23,000	0.3%
BNL-Hs	28	1	WB/OA	~1	2540	~500	~13,000	
SPL-Frejus	2.2	4	WB	0.32	130	~500	~18,000	0.4%
FeHo	8/120	"4"	WB/OA	1~3	1290	~500	~50,000	

Different approaches to have a Low Energy Neutrino Beam

- Energy range ~ 100 MeV – 1 GeV
- OFF-axis beam: neutrino energy is selected by 2-body decay kinematics
- WB at low energy like the SPL

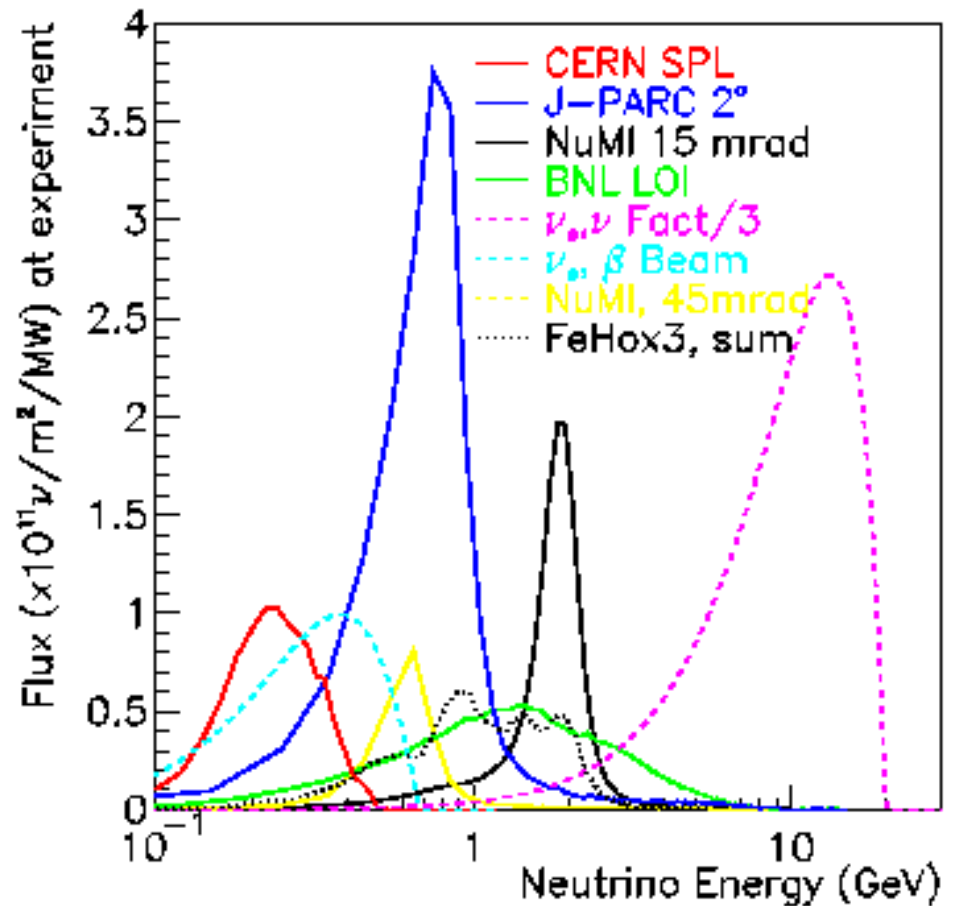

D. Harris. Nufact04

$$\begin{aligned}
 P(\nu_\mu \rightarrow \nu_e) = & 4(s_{23}^2 s_{13}^2 c_{13}^2 + J_{CP} \sin \Delta_{21}) \sin^2 \frac{\Delta_{31}}{2} \\
 & + 2(s_{12} s_{23} s_{13} c_{12} c_{23} c_{13}^2 \cos \delta - s_{12}^2 s_{23}^2 s_{13}^2 c_{13}^2) \sin \Delta_{31} \sin \Delta_{21} \\
 & + 4(s_{12}^2 c_{12}^2 c_{23}^2 c_{13}^2 + s_{12}^4 s_{23}^2 s_{13}^2 c_{13}^2 - 2s_{12}^3 s_{23} s_{13} c_{12} c_{23} c_{13}^2 \cos \delta - J_{CP} \sin \Delta_{31}) \sin^2 \frac{\Delta_{21}}{2} \\
 & + 8(s_{12} s_{23} s_{13} c_{12} c_{23} c_{13}^2 \cos \delta - s_{12}^2 s_{23}^2 s_{13}^2 c_{13}^2) \sin^2 \frac{\Delta_{31}}{2} \sin^2 \frac{\Delta_{21}}{2}
 \end{aligned}$$

$$J_{CP} \equiv s_{12} s_{23} s_{13} c_{12} c_{23} c_{13}^2 \sin \delta$$

Missing parameter in the neutrino oscillation probability:

- θ_{13}
- CP δ phase

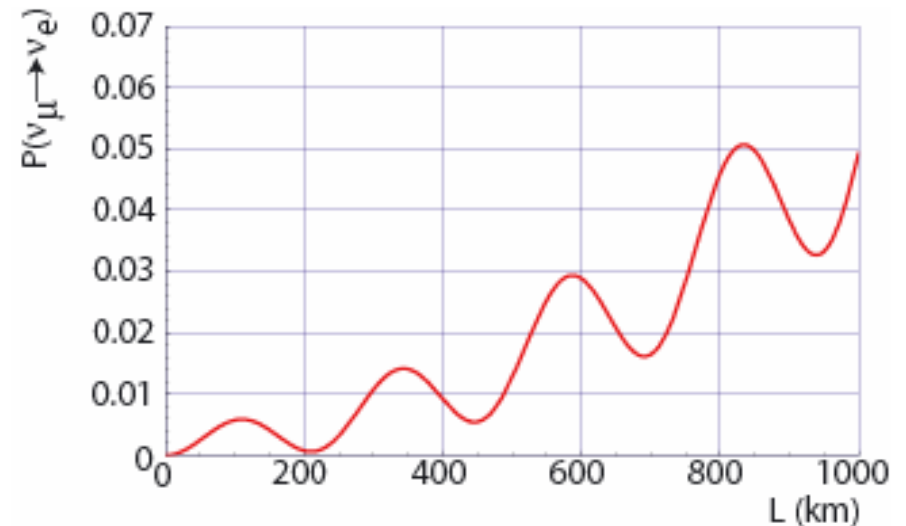

Superbeam flux



How to make a first step to measure θ_{13} and δ ?

Study $\nu_{\mu} \rightarrow \nu_e$ ($\bar{\nu}_{\mu} \rightarrow \bar{\nu}_e$) oscillations at first maximum

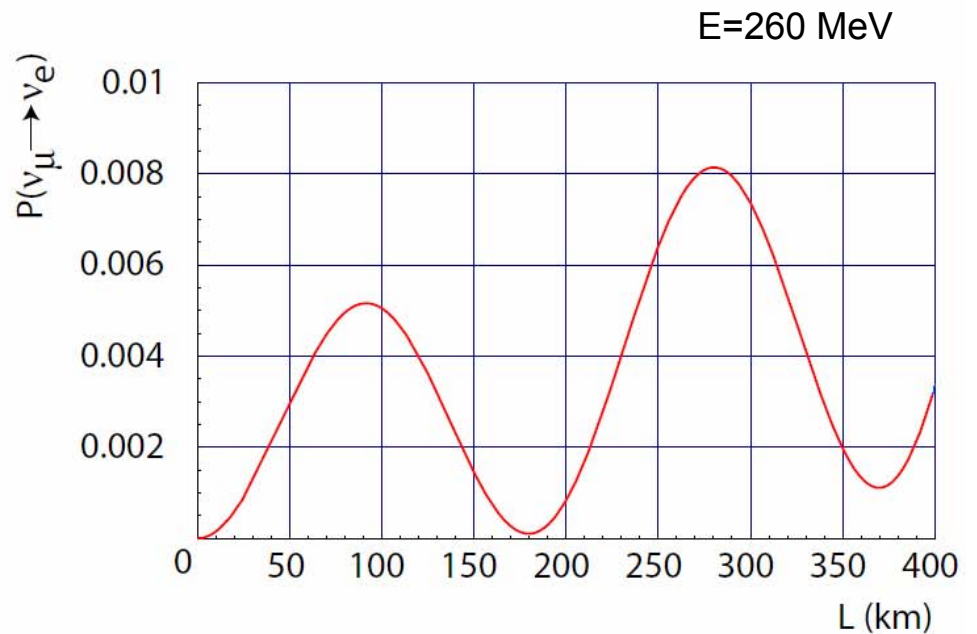
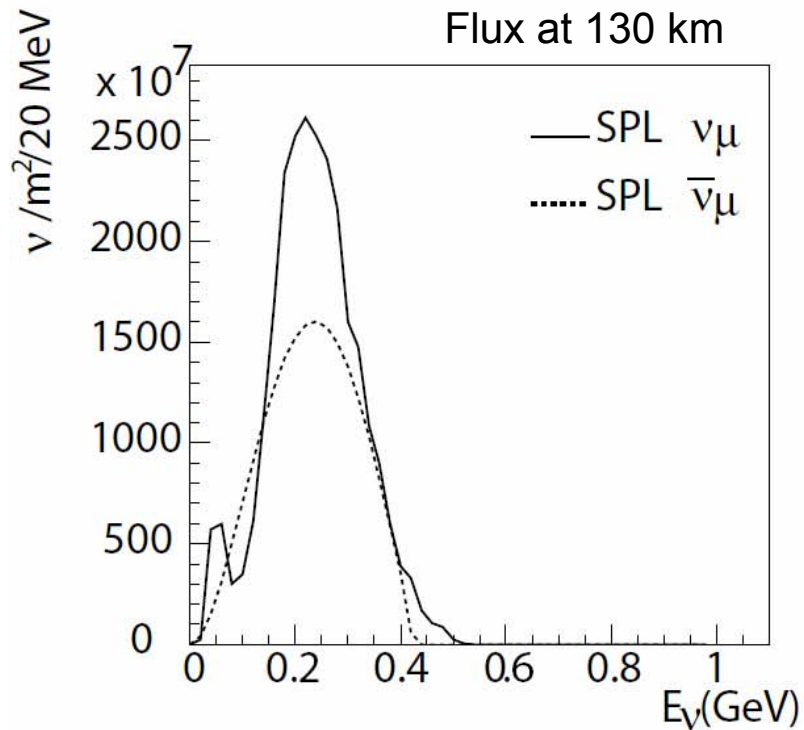



A possible layout of a neutrino factory

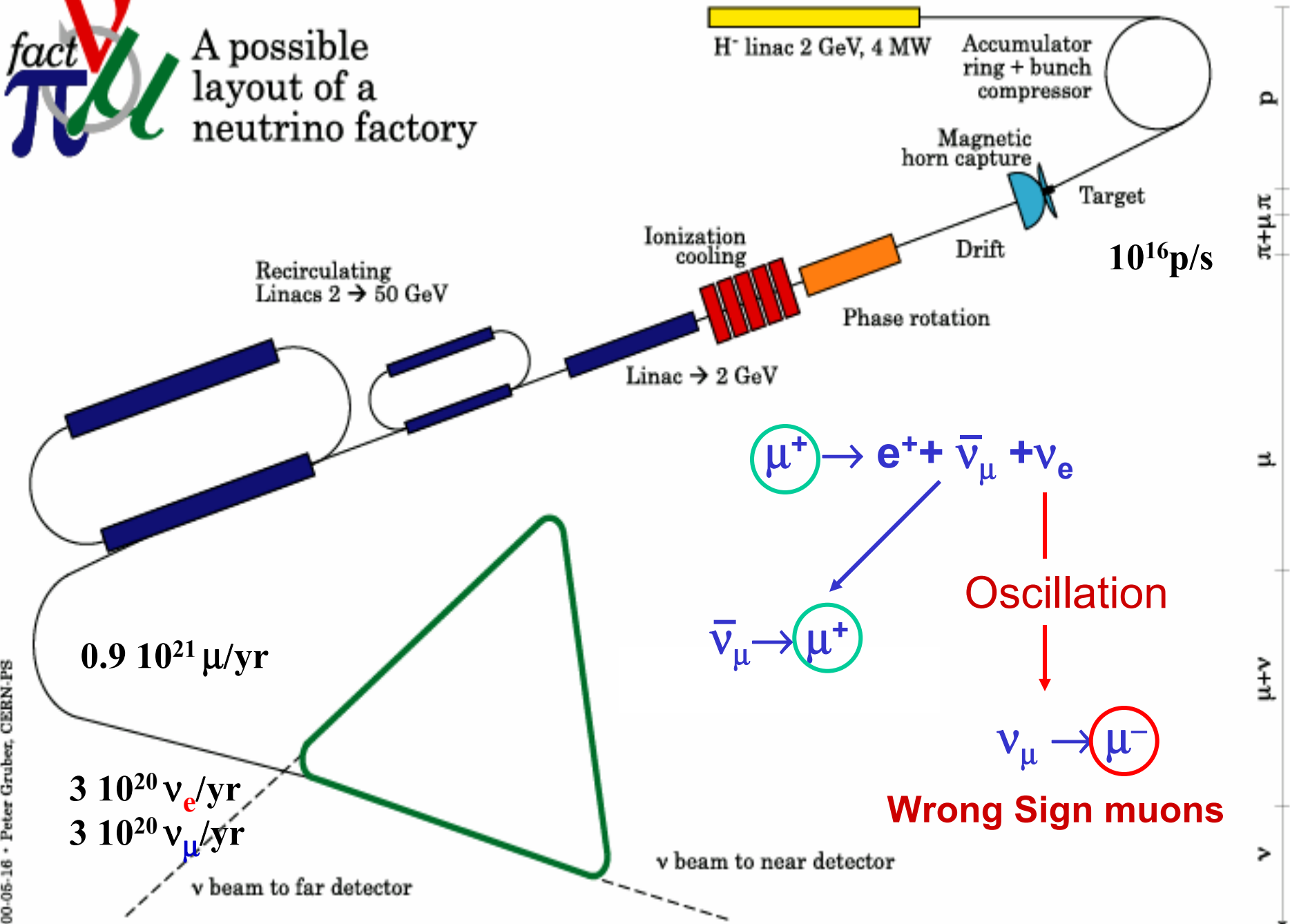

Proposal for a CERN - Super Beam

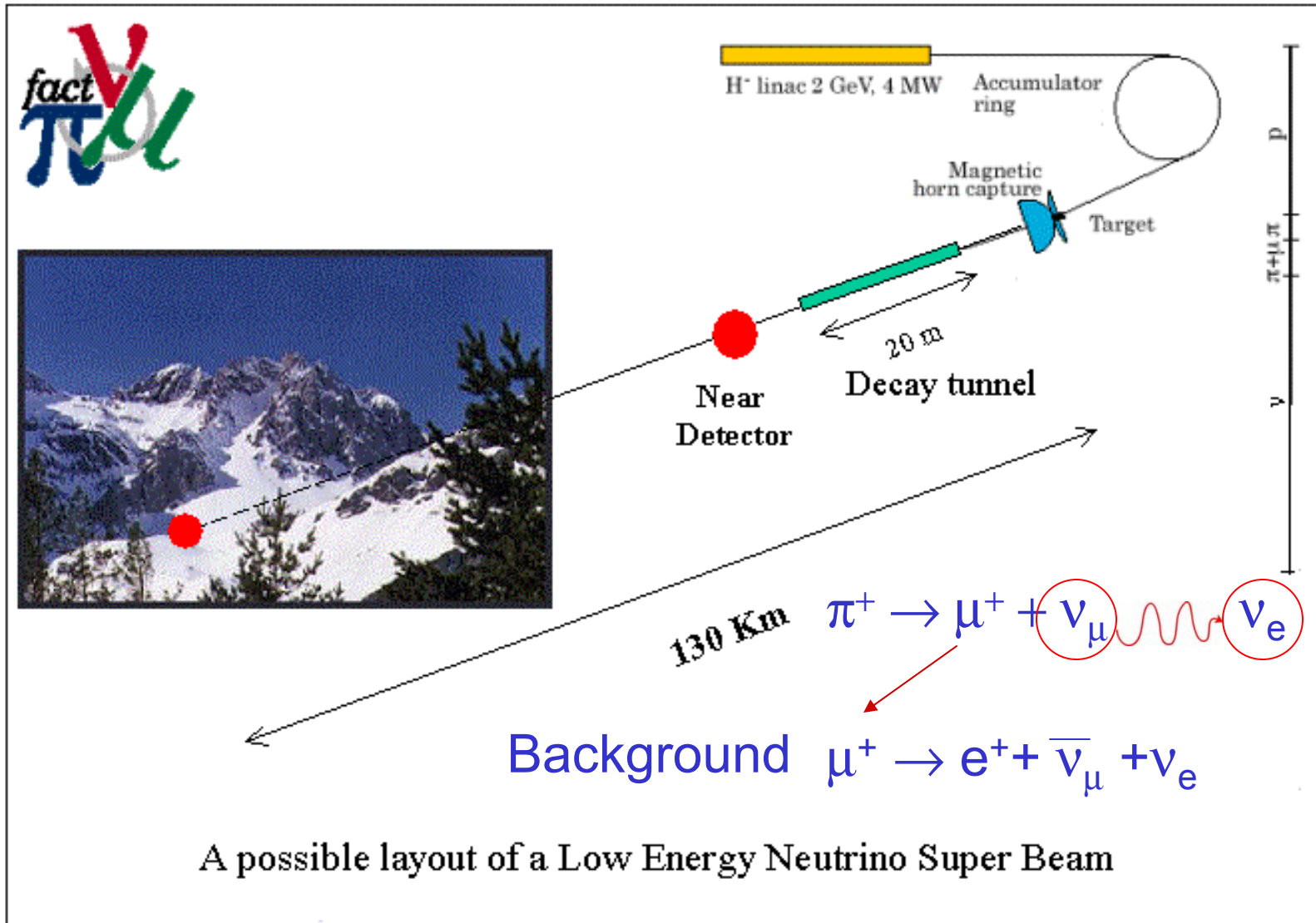



ESA courtesy

SuperBeam parameters

- Proton beam
 - 2.2 GeV
 - 4 MW
 - 50 Hz rep. rate
- Accumulator ring
- Mercury target
- Horn focusing
 - First horn 300 kA
 - Reflector 600 kA
- Low energy pion beam: ≈ 500 MeV
 - proton energy below kaon threshold
 - Short decay channel < 100 m
- Low energy neutrino beam: ≈ 250 MeV

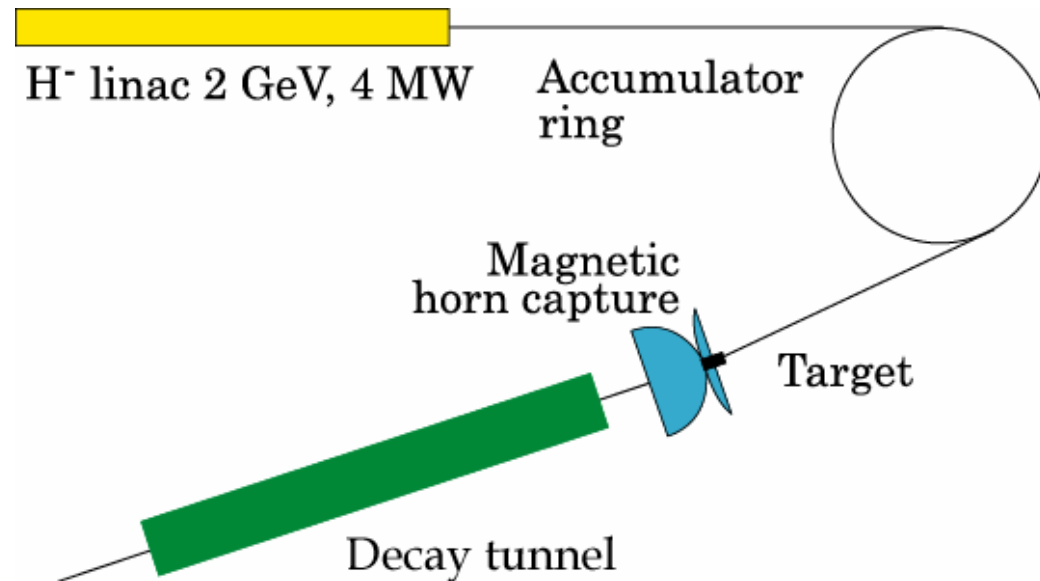

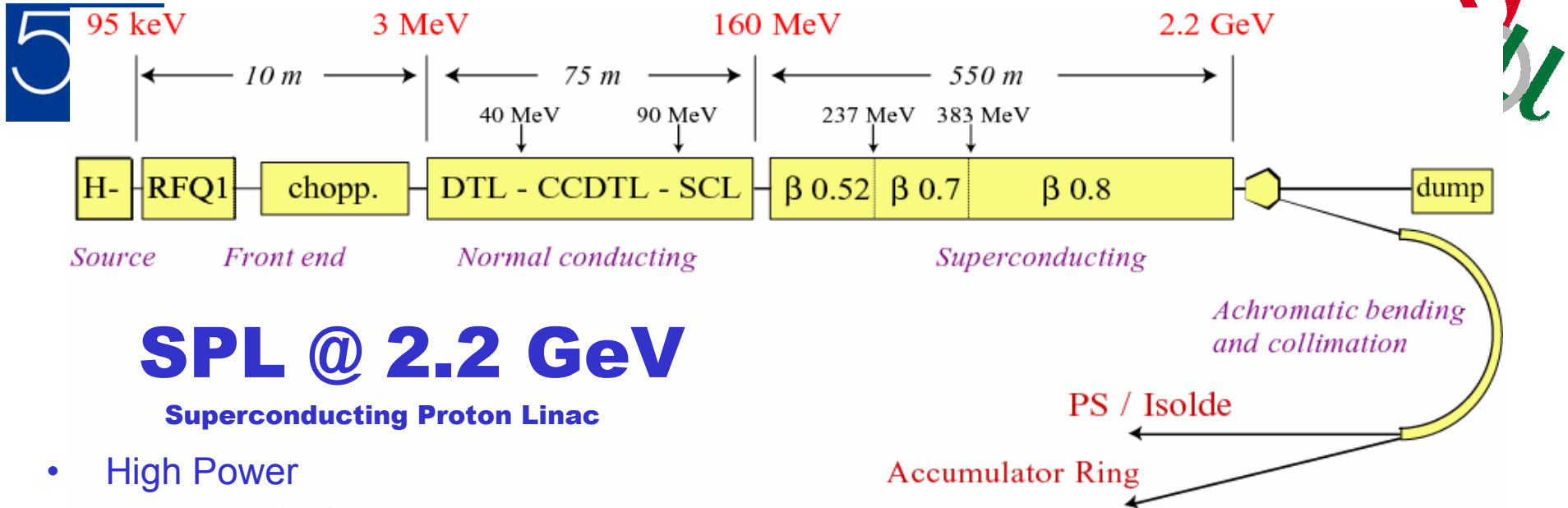

SPL @ 2.2 GeV

Superconducting Proton Linac

- High Power
 - LINAC @ 4 MW
 - Rep. Rate 50 Hz
 - $2.27 \cdot 10^{14}$ p/pulse (1.2 ms burst with 352 MHz bunching & 44 MHz time structure)
- SPL followed by an accumulator ring to reduce the pulse length
- SPL needed for LHC luminosity upgrade and next generation radio-active ion beam facility in Europe (EURISOL)
- 160 MeV linac (“Linac 4”) justified as new PSB injector for LHC (ultimate luminosity and beyond) and ISOLDE (higher flux)
- 3 MeV pre-injector: approved (see Garoby talk yesterday)

Proposed site

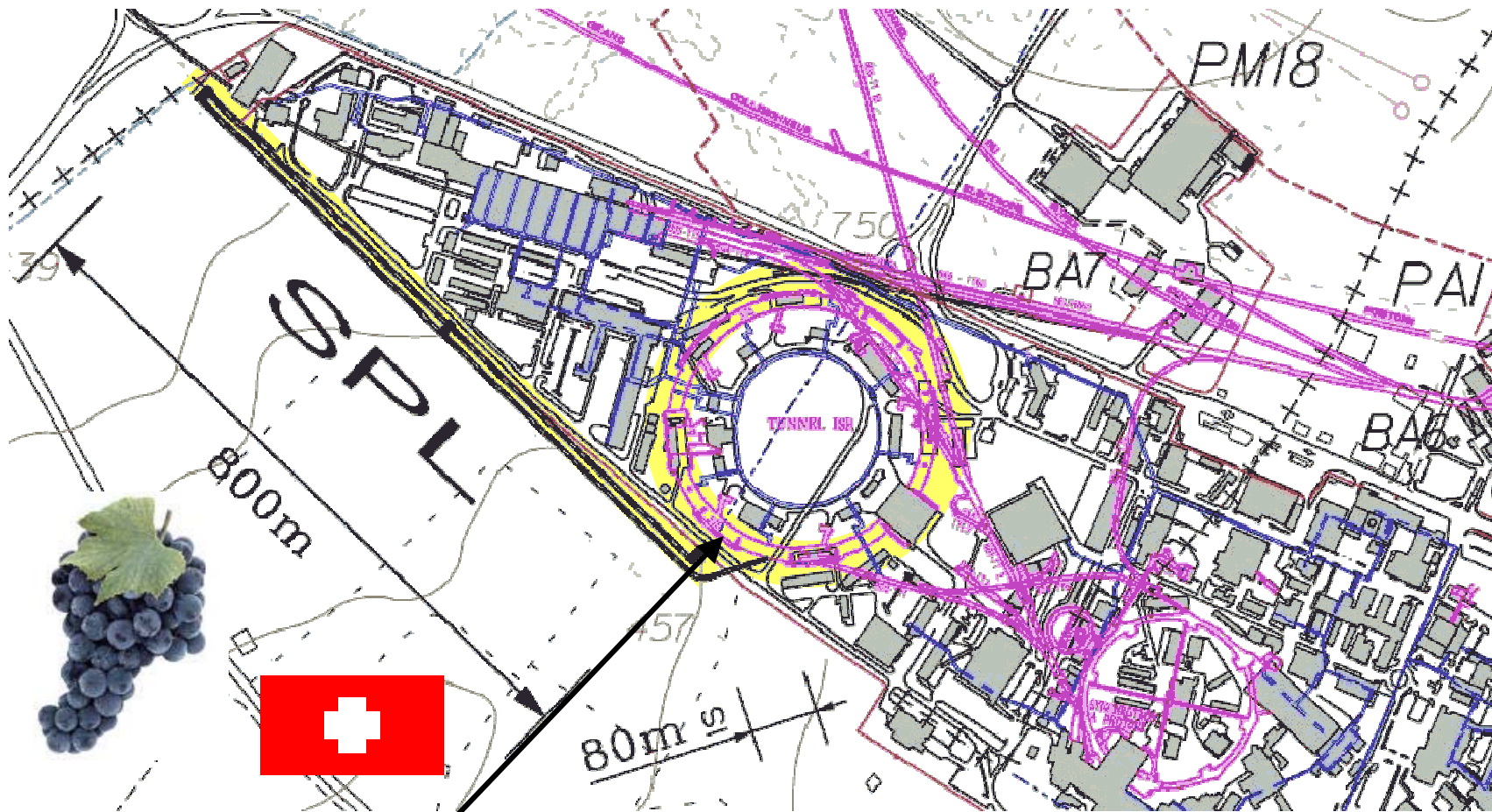

Old ISR tunnel, site of accumulator
Radius = 150 m



Accumulator and Compressor



- Accumulator
 - *Macrobunch* with internal **23 ns** structure (44 MHz)
 - *Macrobunch* Rep. rate: **20 ms** (50 Hz)
 - The energy remain fixed to the LINAC energy: 2.2 GeV
 - Necessary to reject atmospheric background with timing
- Compressor
 - *Microbunch* length reduction from 3.5 ns to 1 ns
 - **This is not required for the Superbeam**

Why the accumulator?

Beam from SPL →

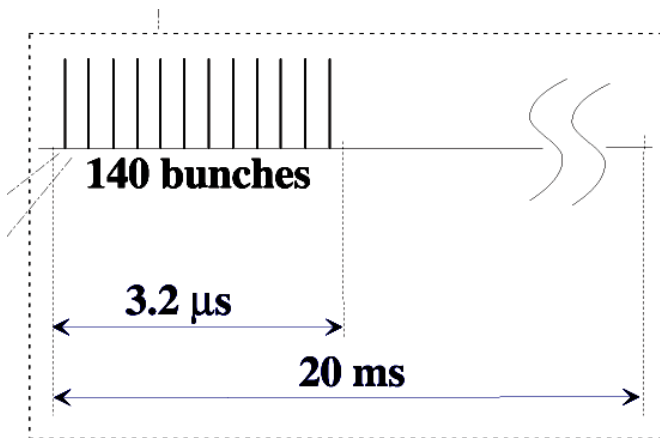
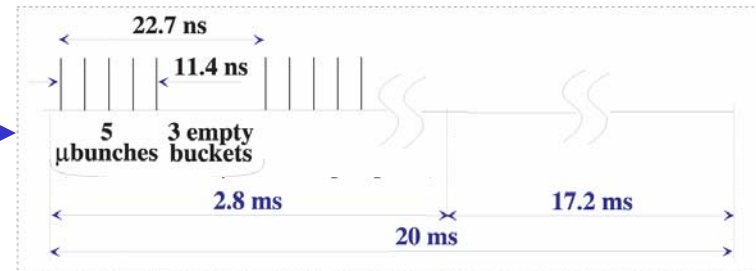

**Beam from
Accumulator** ←

Atmospheric background: 100 evt/kton/y

Detector (40 kton per 5 y): Atmospheric 20000 evts
Superbeam ~ 10 evts

From the SPL: $20 \text{ ms} / 2.8 \text{ ms} \approx 17$

From the accumulator: $20 \text{ ms} / 3.2 \mu\text{s} \approx 6250$



SPL Proposed Roadmap

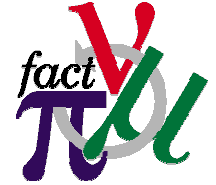

Consistent with the content of a talk by L. Maiani at the “Celebration of the Discovery of the W and Z bosons”. Contribution to a document to be submitted to the December Council (“CERN Future Projects and Associated R&D”).

Assumptions:

- construction of **Linac4** in 2007/10 (with complementary resources, *before end of LHC payment*)
- construction of **SPL** in 2008/15 (*after end of LHC payments*)

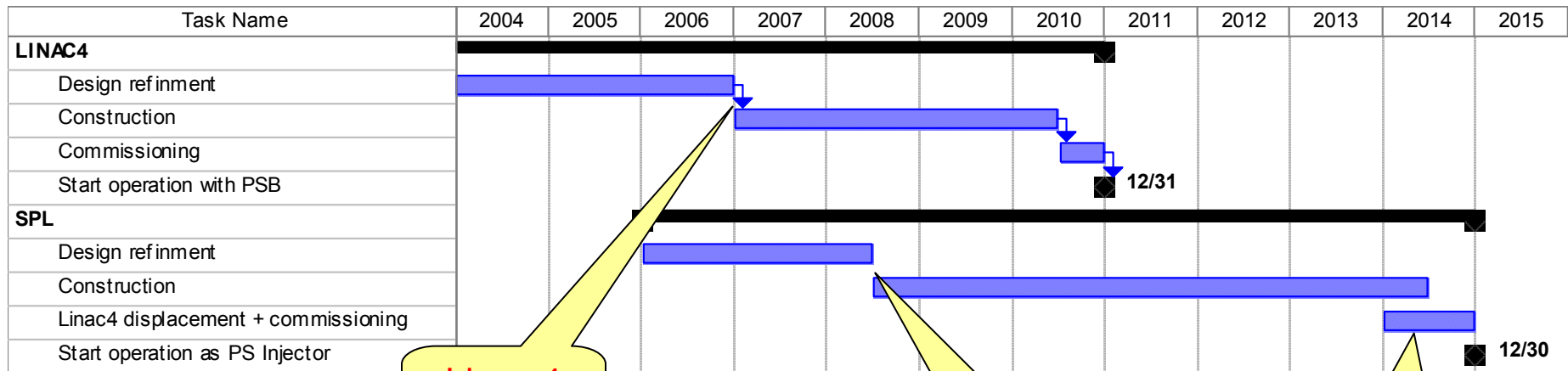

R. Garoby

Linac 4 approval

SPL approval

LHC upgrade

**Warning: Compressor ring and detector (8 years) are not quoted
Protons from the SPL ready in 2015**

Target SuperBeam/Nufact

- Target:
 - Mercury: $Z = 80$ → short target
Liquid → easy to replace
($v_{//} \approx 20$ m/s)
 - Dimensions: $L \approx 30$ cm, $R \approx 1$ cm

→ 4 MW of proton into more or less a pint of beer

4 MW
=
40000 ×

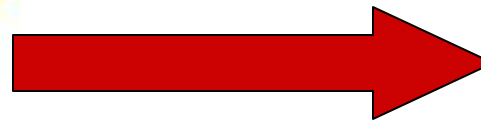

Pion yield from 2.2 GeV

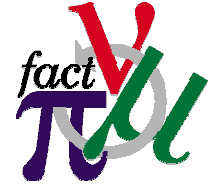

- Different material pion production simulated with MARS
- Obs: Carbon will not survive at 4 MW

Material	Z	A	Melting point (°K)	λ_I (cm)	density(g/cm ³)
C	6	12	3800	38.1	2.265
Ta	73	180	3290	10.4	16.650
Hg	80	200	628	13.0	13.570

Material	π^+ per p.o.t.	π^- per p.o.t.
C	0.30	0.153
Ta	0.183	0.174
Hg	0.185	0.186

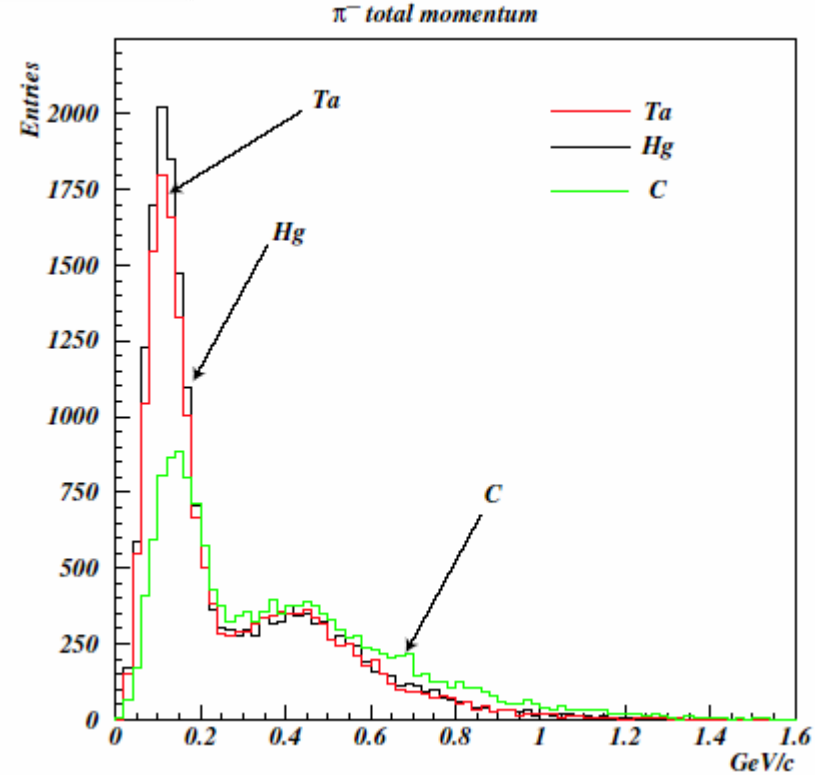
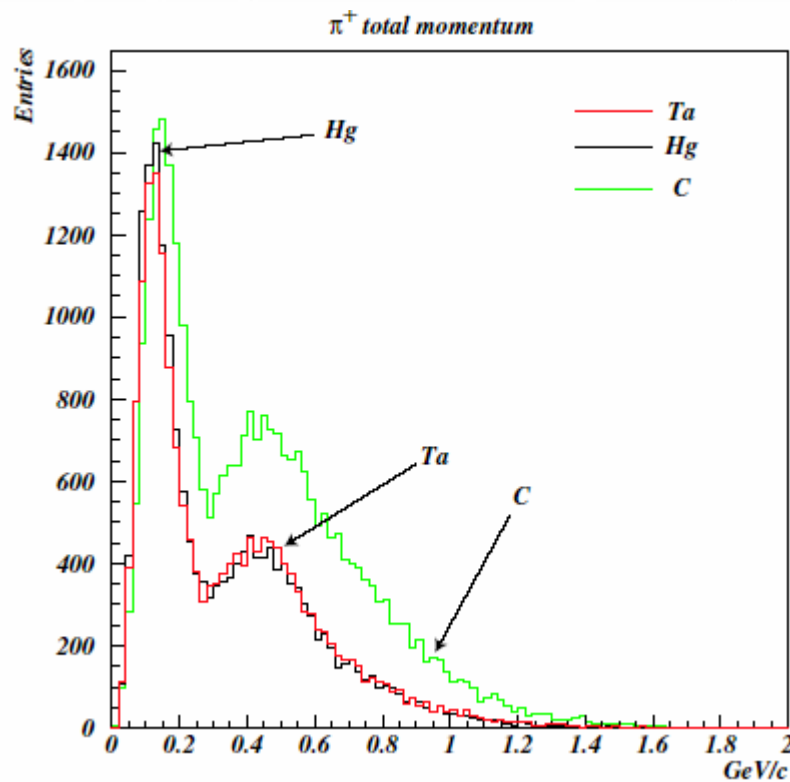

Hg Jet test a BNL E-951

Event #11 25th April 2001

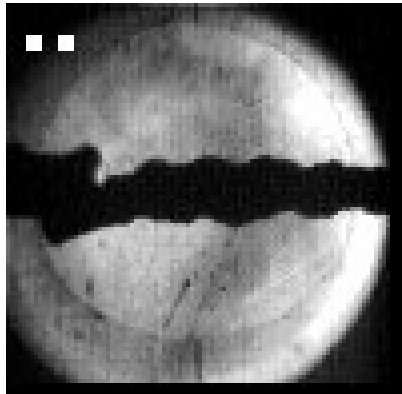

Protons ←

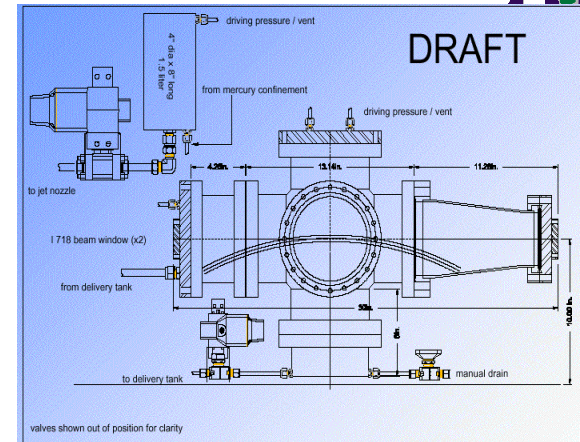
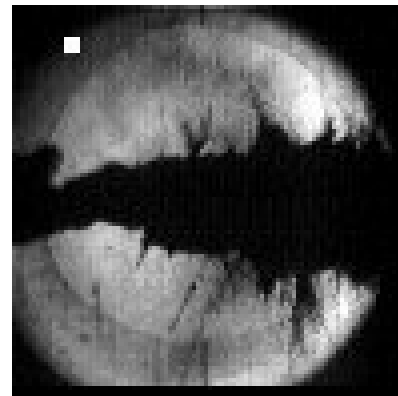
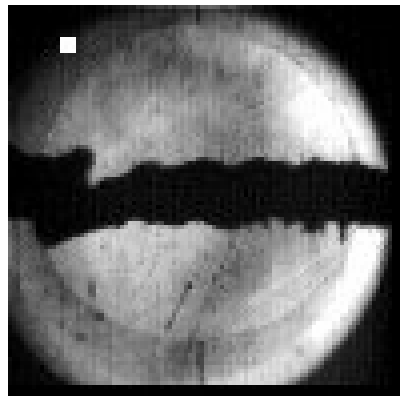

Picture timing [ms]

0.00

0.75

4.50

13.00

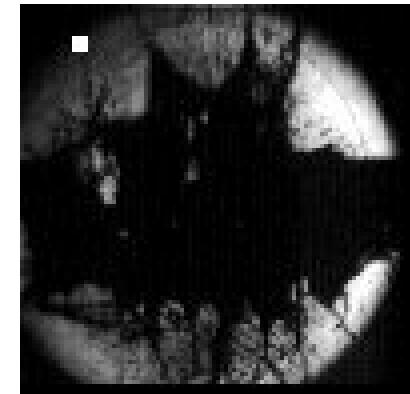

P-bunch: 2.7×10^{12} ppb
100 ns

$t_0 = \sim 0.45$ ms

Hg- jet : diameter 1.2 cm
jet-velocity 2.5 m/s
perp. velocity ~ 5 m/s

K. Mc Donald, H. Kirk, A. Fabich



Proposed experiment @ CERN

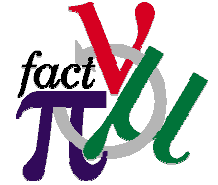

- Target Experiment proposed at TT2A @ CERN for proof-of-principle test of a liquid jet target for high power proton beams
- Completion of the target R&D for final design of the Hg-Jet

	ISOLDE	GHMFL	BNL	TT2A	SuperB/NuFact
p+/pulse	$3 \cdot 10^{13}$	----	$0.4 \cdot 10^{13}$	$2.5 \cdot 10^{13}$	$3 \cdot 10^{13}$
B [T]	---	20	---	0 or 15	0 or 20 T
Hg target	static	15 m/s jet (d=4mm)	2 m/s jet	20 m/s jet	20 m/s jet (d=10mm)
	DONE	DONE	DONE	OPTION	DESIGN

Experimental setup: 15 T solenoid + Mercury Jet + PS beam

IMPORTANT: This experiment with the SOLENOID OFF is fundamental to understand jet disruption in the HORN neck

Magnetic horn

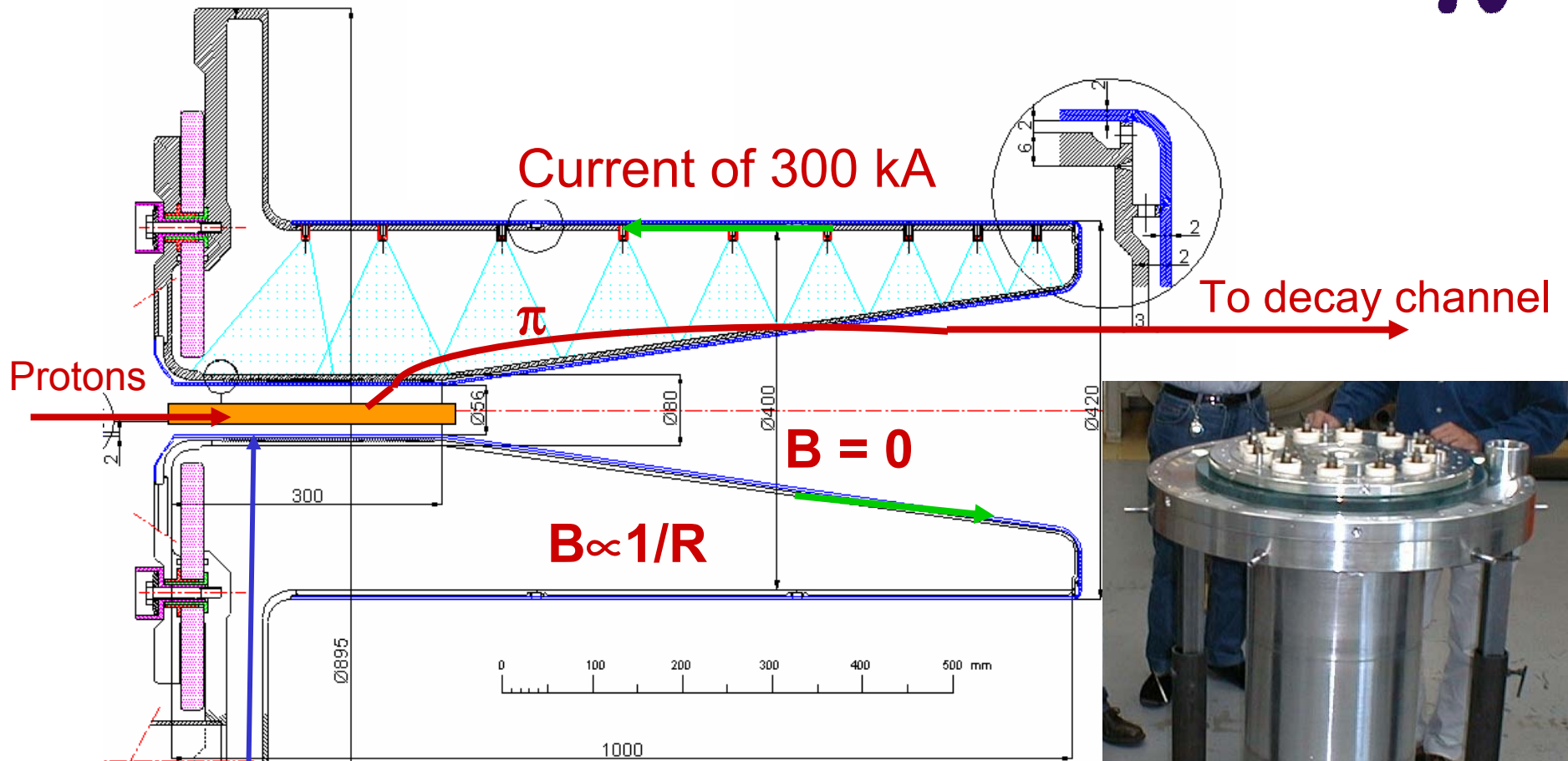

NEUTRINO FACTORY - Horn 1 prototype

S. Rangod
15/05/2001



Hg Target

Horn prototype @ CERN



Horn typical design

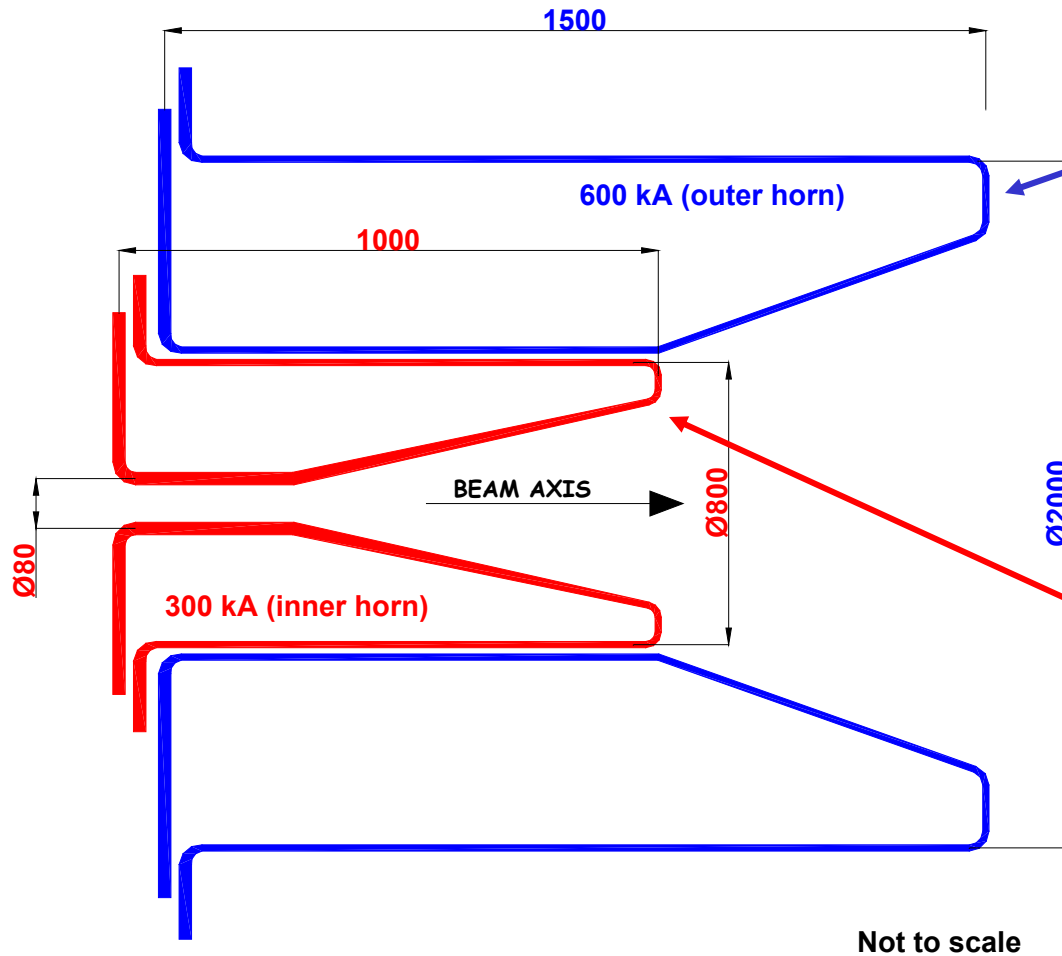
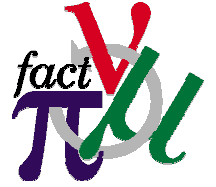

Outer horn
Reflector like
Optimized for
SuperBeam

Inner horn
Same as Nufact



Horn design strategy



- Useful pions:
 - $E_k = 500 \text{ MeV}$
 - Max Neutrino Energy $\approx 270 \text{ MeV}$
 - Max point-to-parallel production angle
 - $I = 300 \text{ kA} \Rightarrow \theta_{\text{max}} = 12 \text{ degrees}$
 - $I = 600 \text{ kA} \Rightarrow \theta_{\text{max}} = 17 \text{ degrees}$
- Geometrical constraints:
 - Nothing in front of the primary proton halo
 - Nothing along the mercury direction
 - Maximum energy stored in the magnetic volume



Decay tunnel



- Decay channel used to control the beam related background
 - muon decay
 - wrong sign pions
- Length of typical 20 to 100 m since low energy pions
- Radius of 1 or 2 m tuned to cut the beam background
- Studies about activation of shielding/earth around decay channel already published using CNGS experience
 - Is it possible to have a 4 MW target station in the CERN area? **YES**

Flux computed by:

MARS for particle production+HORN

Nubeam standalone program (M. Donega)

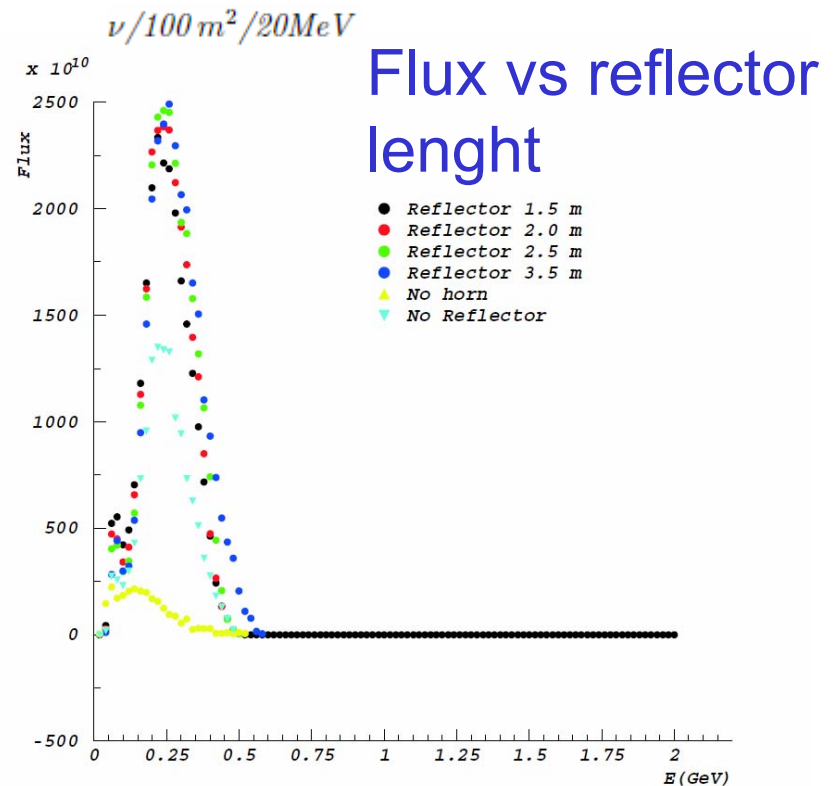
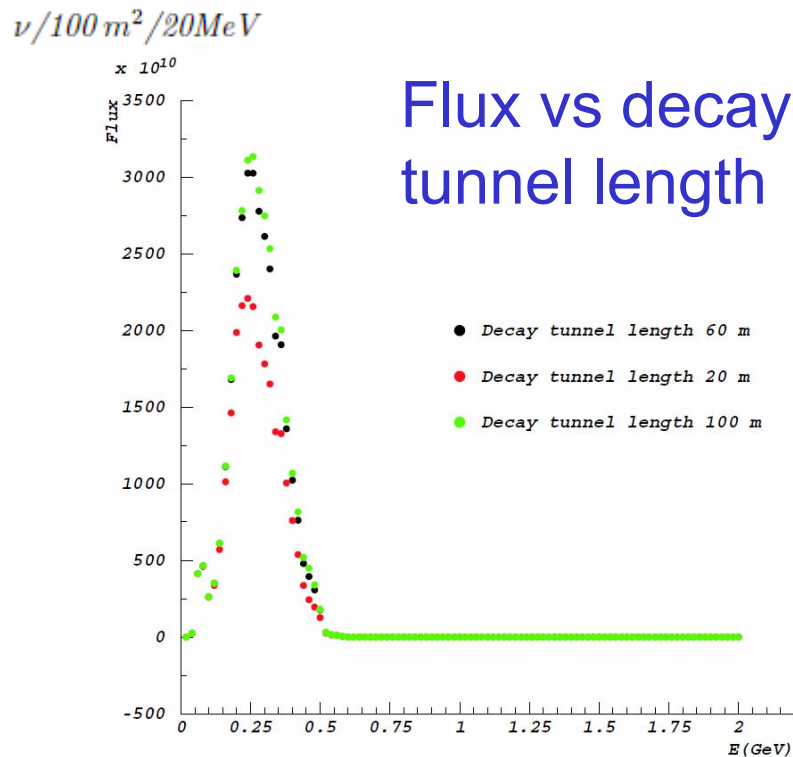

Maximum neutrino flux → longer decay channel

Beam background sources:

1. ν_e from muon decay → controlled with decay tunnel geometry
Typical content 0.004 at peak
2. ν_e from kaon decay → kaon production not too relevant, low energy proton

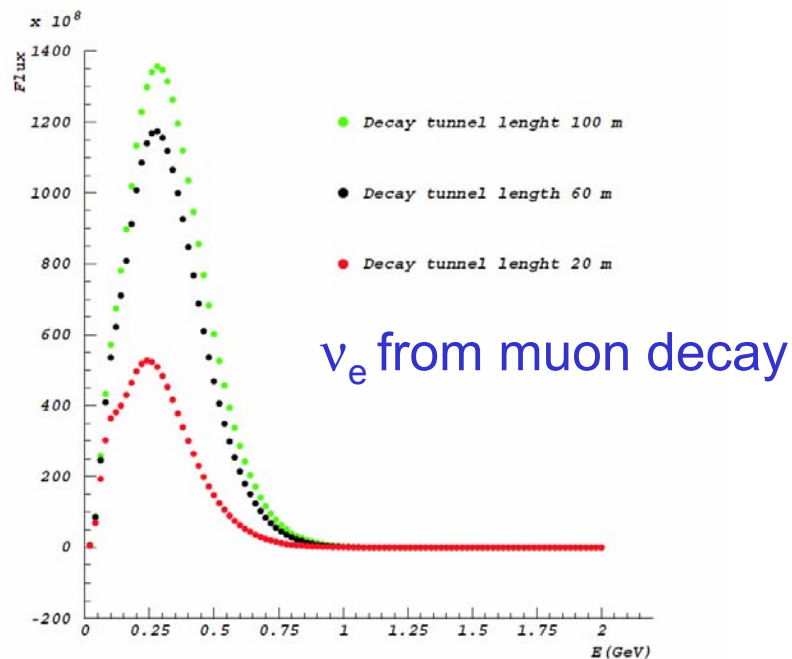

Number for 500 000 pot

energy of the protons that create a kaons

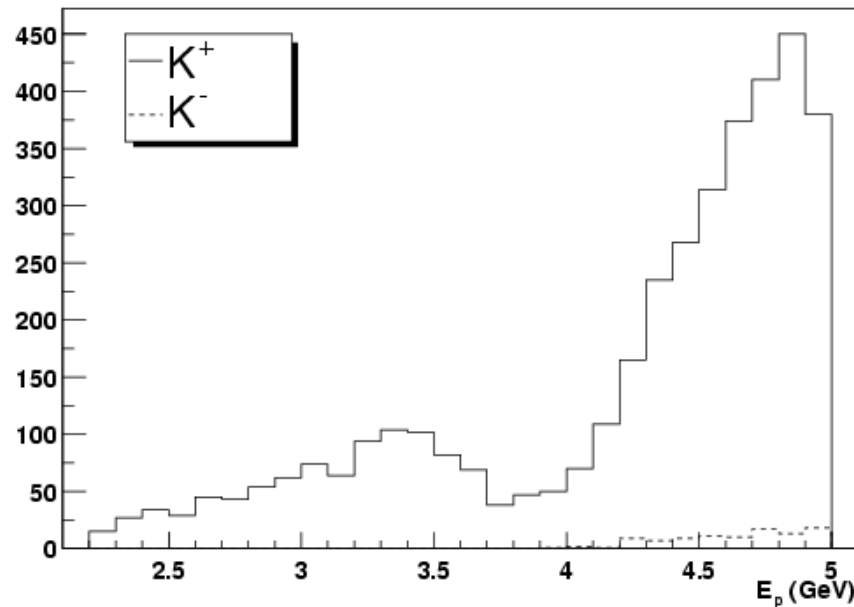

energy of the protons that create a pions

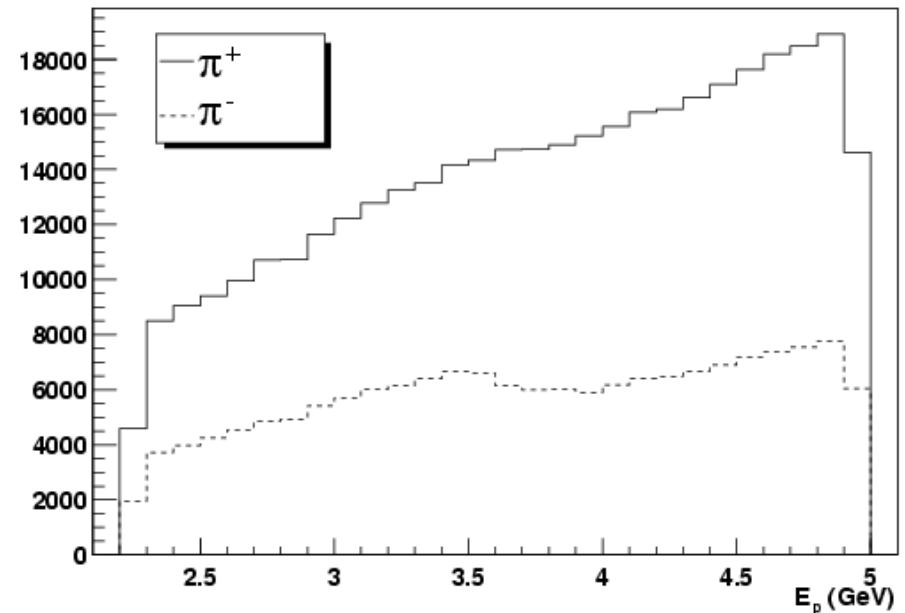

- Two production processes (origin to be investigated in MC-Fluka)
- Anyway below 4 GeV, K^+ production < 300 times the π^+ production.
- neutrino production associated to K^+ seems to be negligible at 2.2 GeV

A. Cazes - LAL

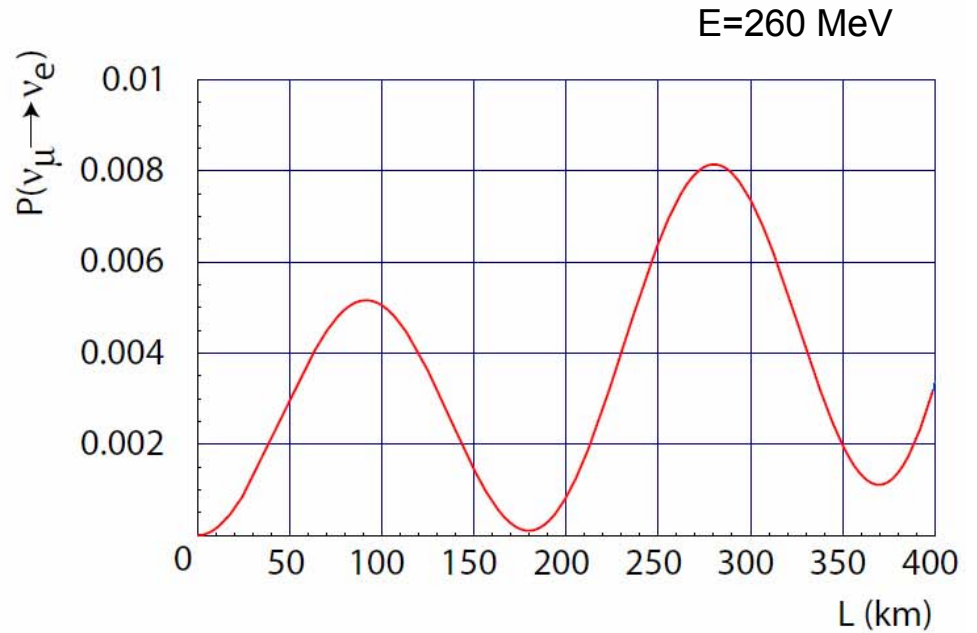
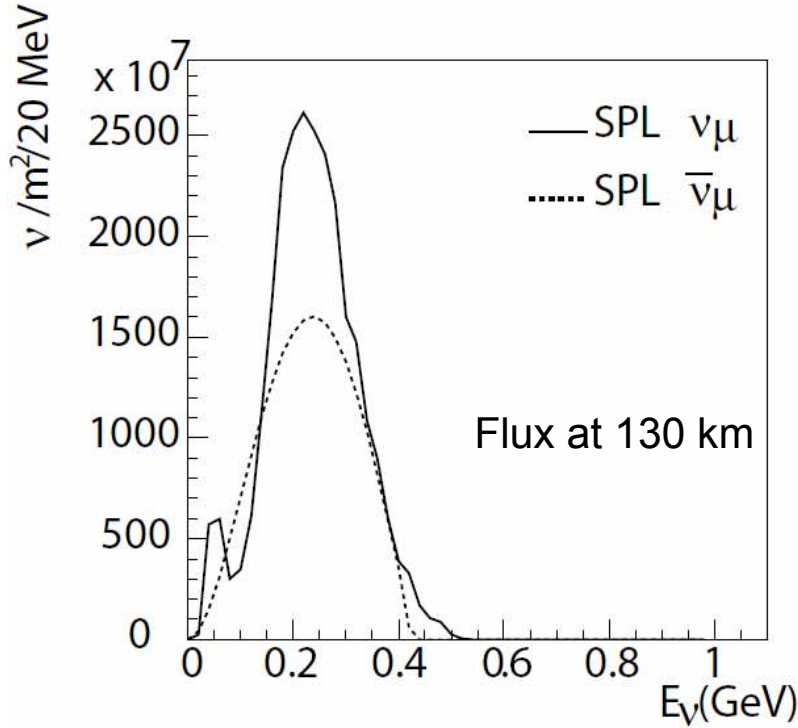

	ν_μ	$\bar{\nu}_\mu$
Neutrino flux ($\nu/m^2/yr$)	$4.78 \cdot 10^{11}$	$3.33 \cdot 10^{11}$
Neutrino average Energy	0.27 GeV	0.25 GeV
CC events	36698 (2 yrs)	23320 (8 yrs)
Oscillated	1279	774

$$\theta_{12} = 31.7^\circ \quad \Delta m_{12}^2 = 7 \cdot 10^{-5} eV^2$$

$$\theta_{23} = 45^\circ \quad \Delta m_{23}^2 = 2.5 \cdot 10^{-3} eV^2$$

$$\theta_{13} = 10^\circ$$

2 years of π^+

8 years of π^-

M. Mezzetto, NuFact 03

UNO-like detector

UNO Detector Conceptual Design

A Water Cherenkov Detector optimized for:

- Light attenuation length limit
- PMT pressure limit
- Cost (built-in staging)

60x60x60m³x3
 Total Vol: 650 kton
 Fid. Vol: 440 kton (20xSuperK)
 # of 20" PMTs: 56,000
 # of 8" PMTs: 14,900

APS nu Study at ANL, Dec. 2003

Obs: SuperBeam as a “customer” of a multipurpose detector

Frejus lab/tunnel location

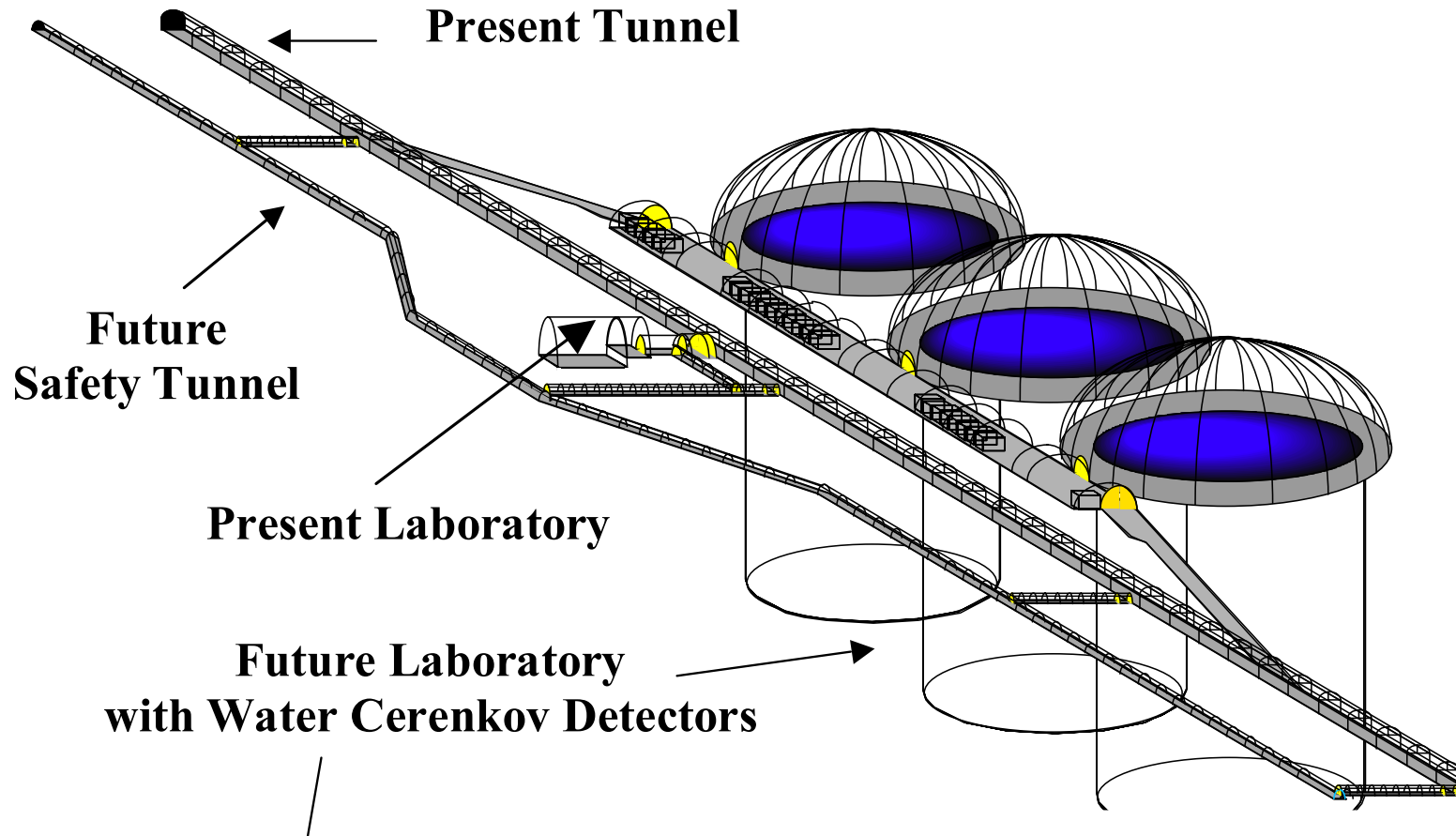

See Mosca talk

μ/e Background Rejection

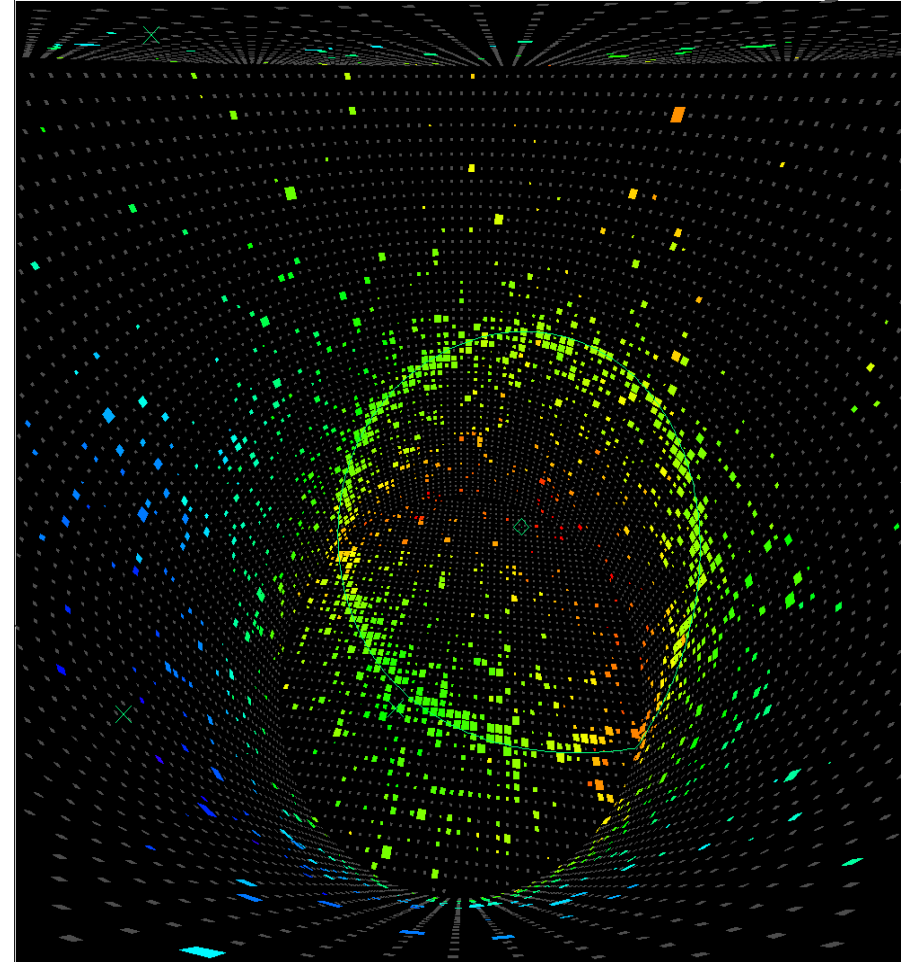
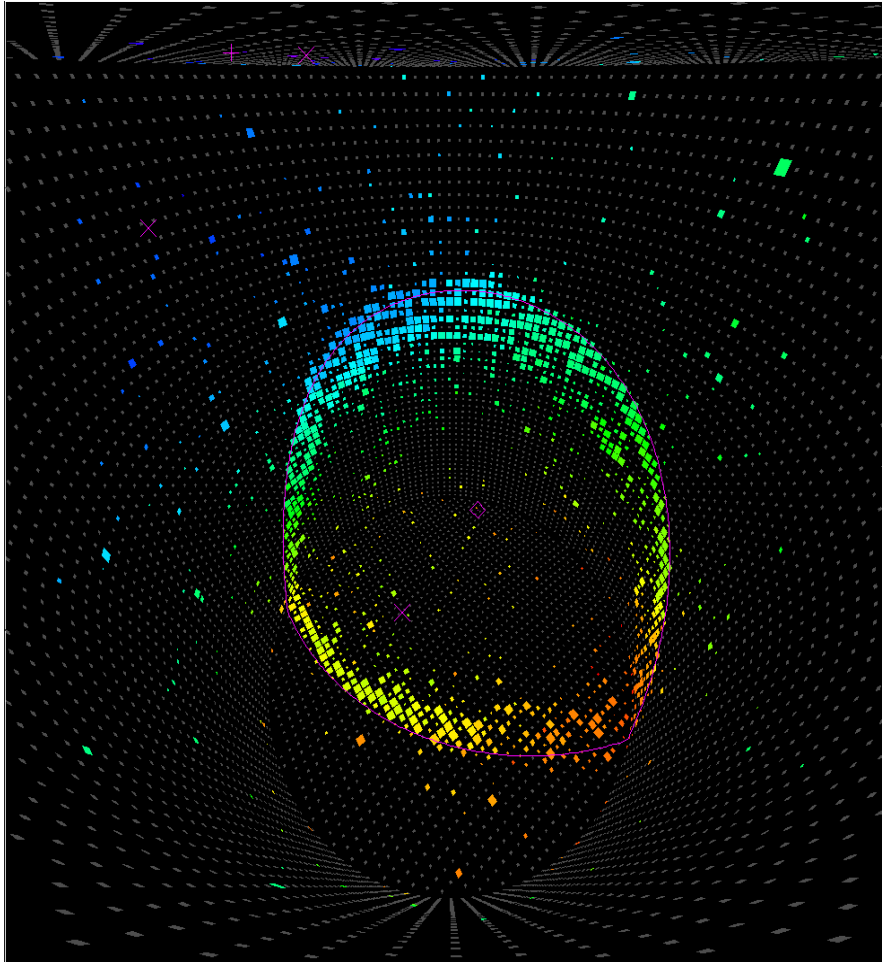

π^0 event from K2K

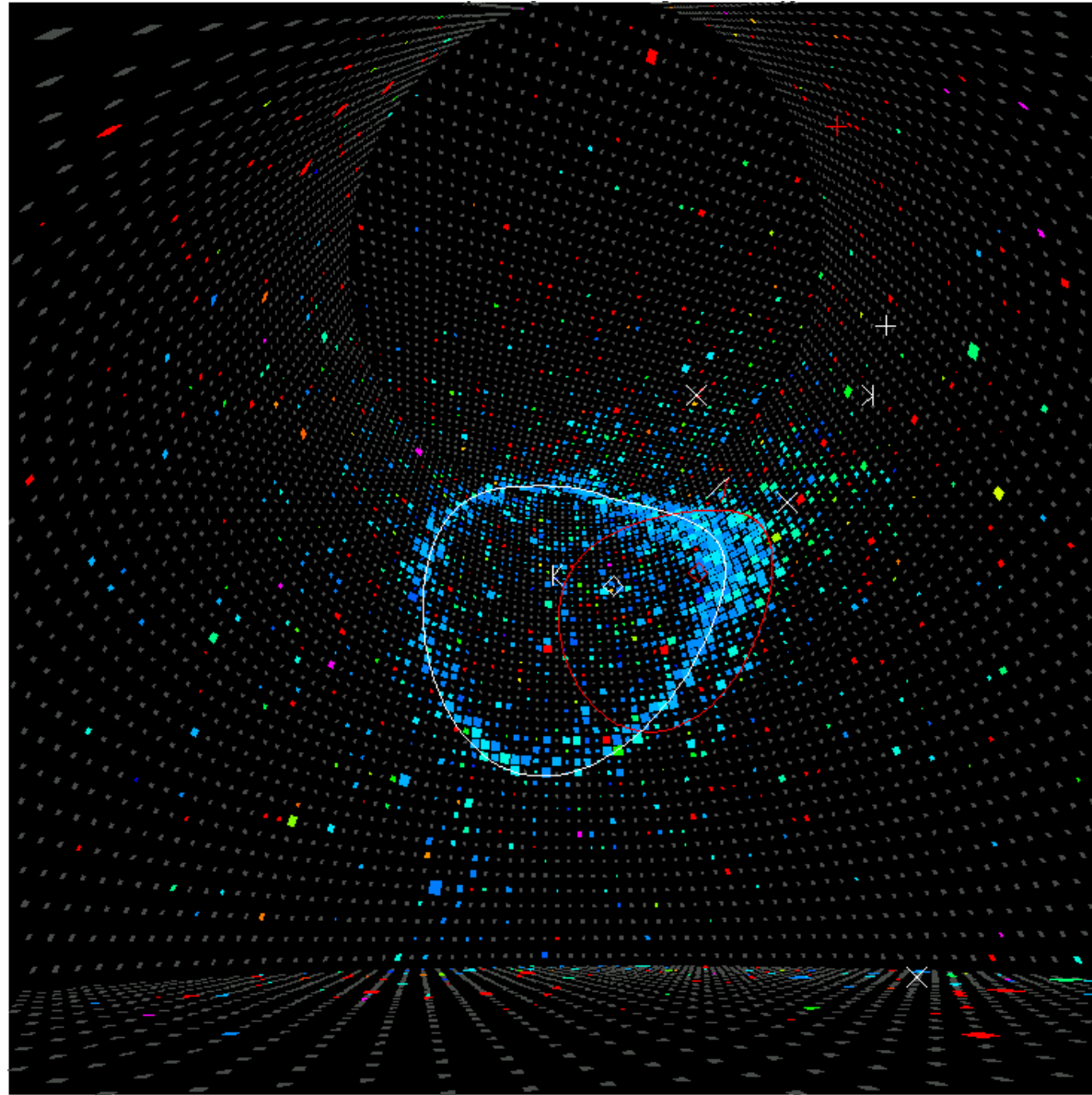
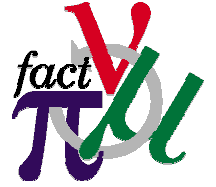

Two rings similar to ν_e events due to small two ring separation

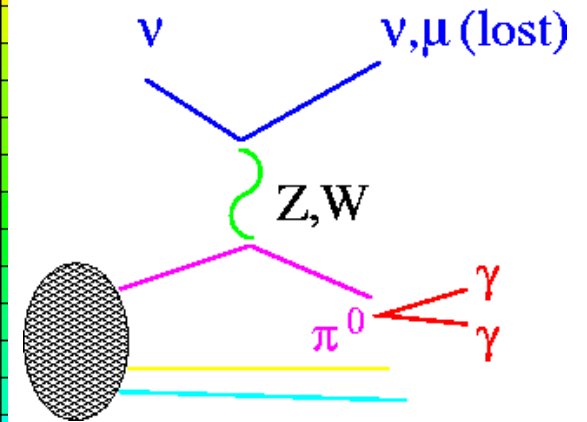

π^0 production suppressed because of low energy neutrinos

Not the case for J-PARC

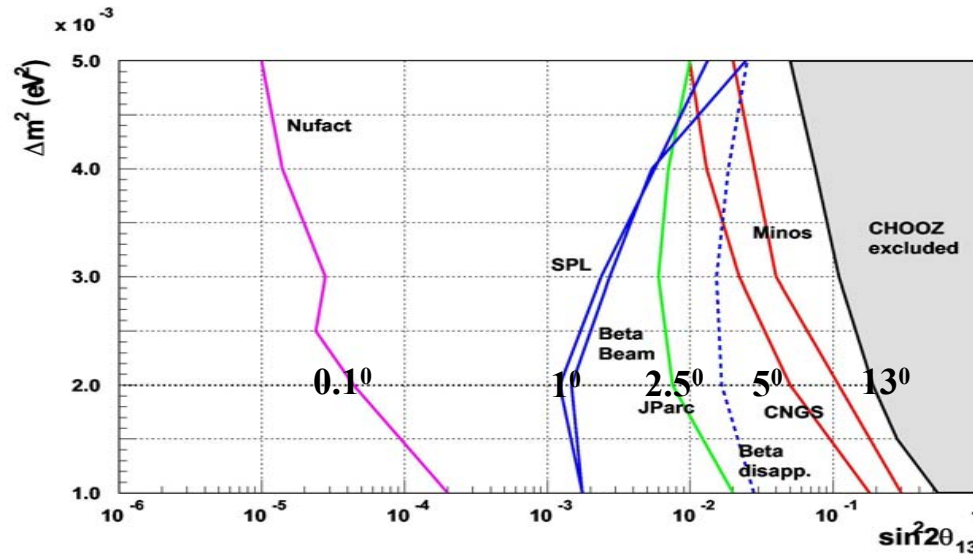

The CERN Superbeam would be able to measure θ_{13} down to $\sim 1^\circ$

The CERN Superbeam can approach the measurement of the CP violation

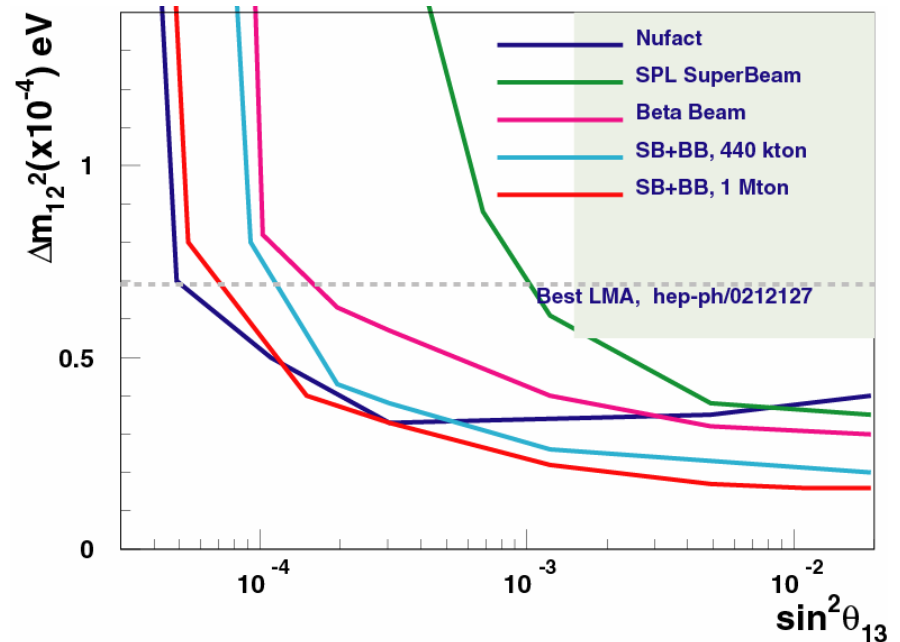

From M. Mezzetto

SUPER BEAM ONLY

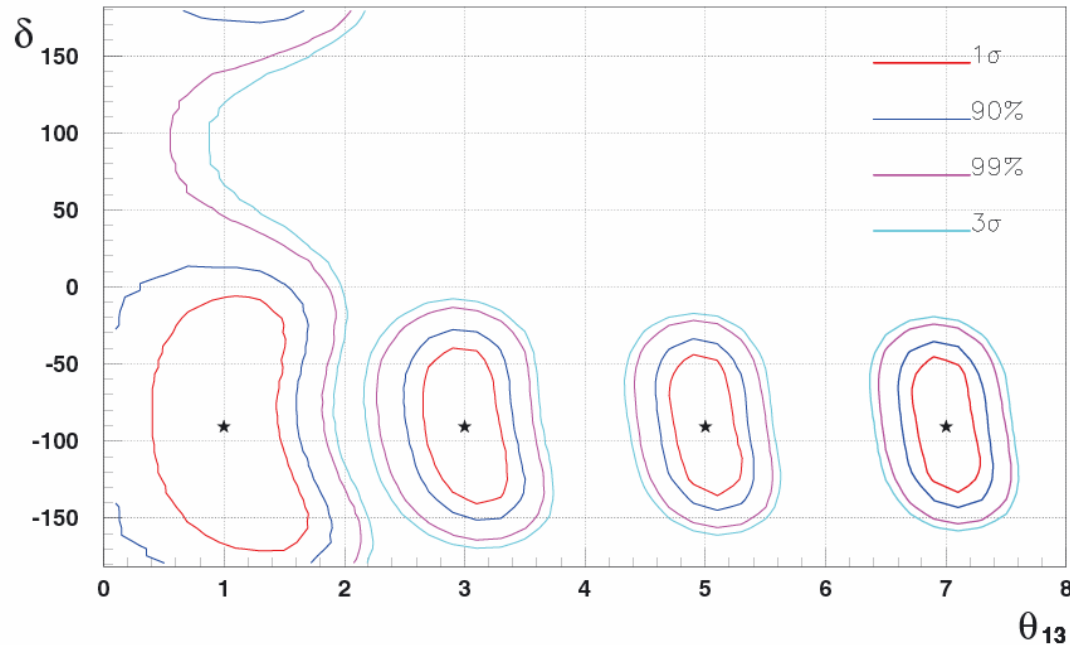

CP violation measurement limited by the antineutrinos and the difference of the cross section at this energies where Q-E interaction dominates

Neutrino Cross section interaction From Lipari

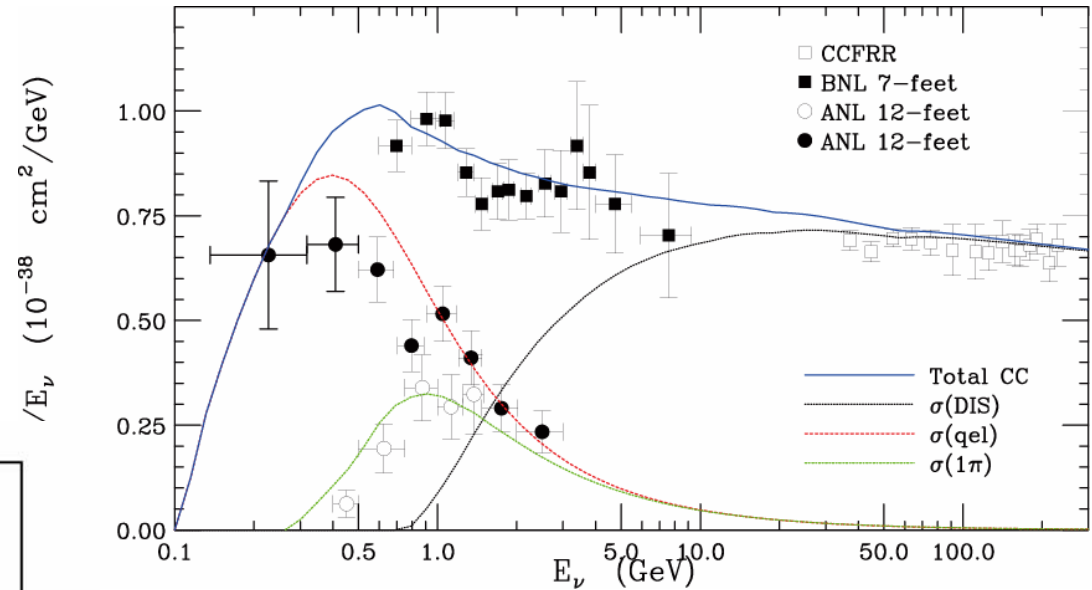
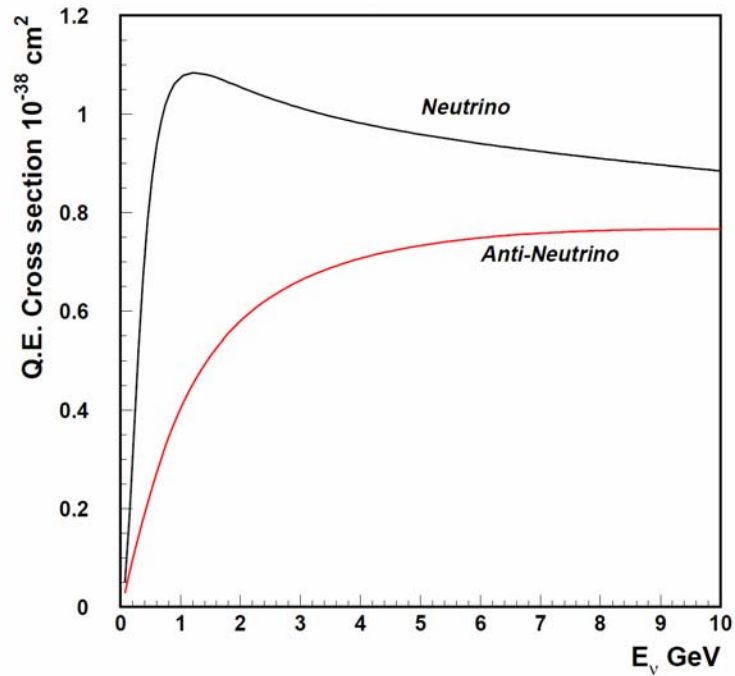

- Low energy is a limitation for antineutrinos
- Ratio of cross section is approx 5
- Trying to increase a bit neutrino energy



SPL SuperBeam FAQ



Q: Why 2.2 GeV for the proton driver?

A: First design of the SPL which used the LEP cavities.

Q: What about increasing the proton energy ?

A: Possible up to 3.5 GeV- 4 GeV with some caveats. Energy optimization to tune the proton beam energy is in working stage (see next slides).

Q: Is the SPL SuperBeam strongly connected with the Frejus?

A: Yes, due to low energy of proton beam no way to go further than 130 km.

Q: What if instead of a Cherenkov detector one wants to use a Liquid Argon TPC ?

A: Possible if the experts are interested in the location (meaning not going to Japan)

Q: Why proposing the SPL Superbeam if JHF will have similar results?

A1: Unique synergy with the Beta Beam

A2: Learned from the Japanese style of working, and also from CERN style, every step carries the know-how for the next step. The next could be a NuFact.

A3: Different condition to repeat the same measurement. In particular different background.

New study and optimisation

J.E. Campagne, A. Cazes LAL, Orsay

- Horn shape optimisation for 260MeV or 350MeV neutrinos
- decay tunnel length and radius
 - $10\text{m} < L < 60\text{m}$
 - $1\text{m} < R < 2\text{m}$
- SPL energy optimisation
 - 2.2GeV, 3.5GeV, 4.5GeV \rightarrow 8GeV

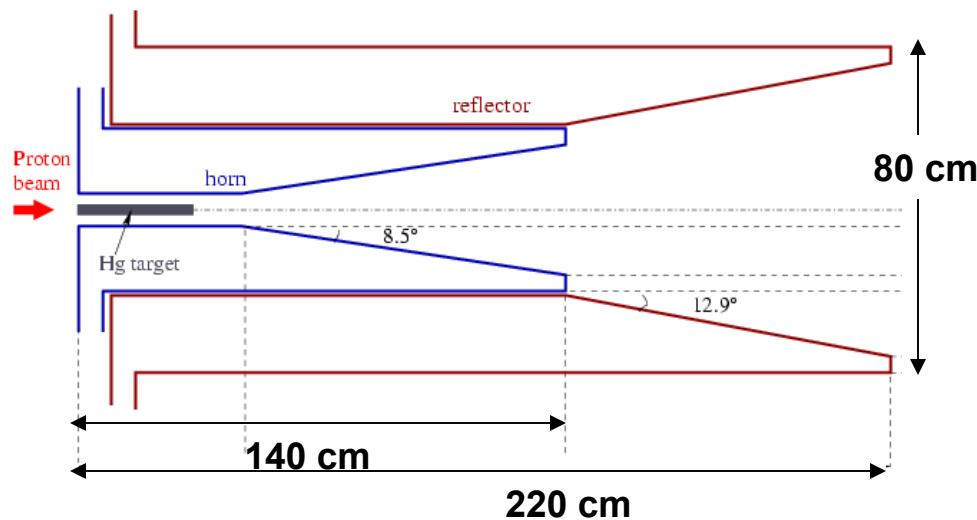
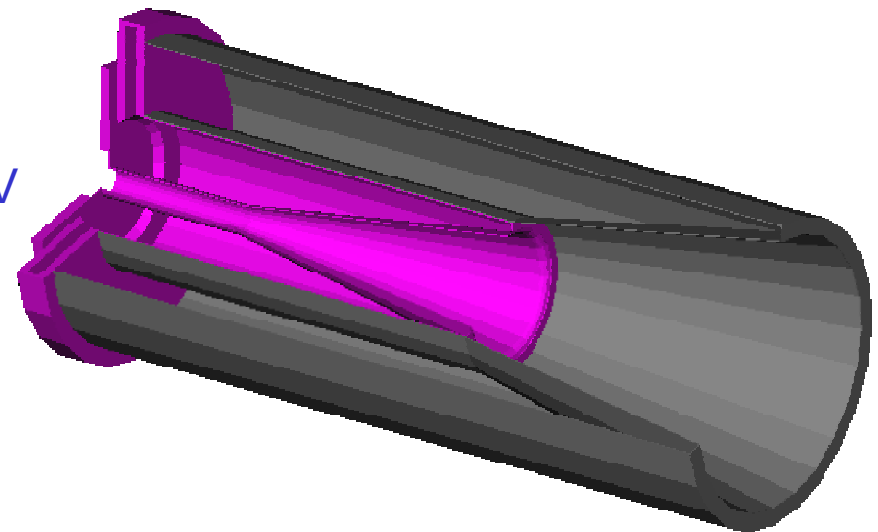

New simulation including kaons decays.

Target simulated with FLUKA

- Sensitivity computed thanks to **Mauro Mezzetto's** code.
- Best results for
 - SPL at **3.5 GeV**
 - Horn designed for **350 MeV** neutrinos
 - Decay tunnel : **40 m** long, **2 m** radius

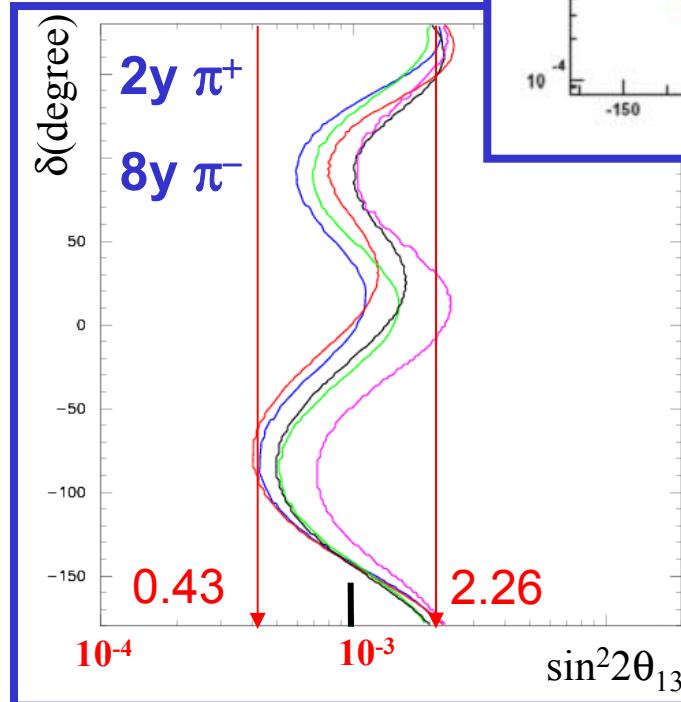
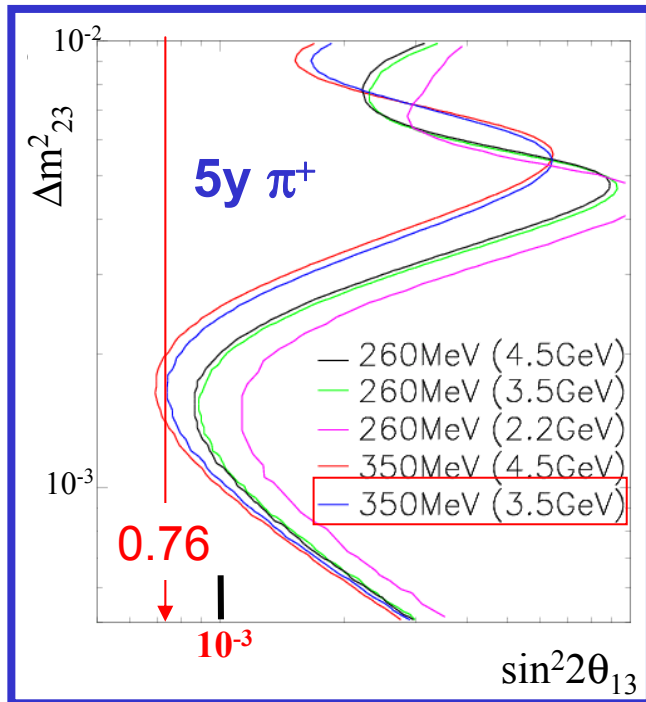
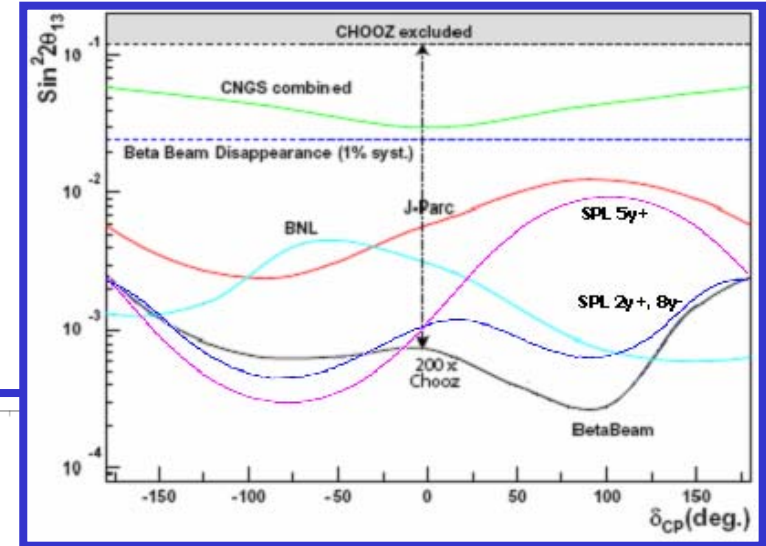

440 kT, $\epsilon_{\text{sys}} = 2\%$
130km from CERN

$$\Delta m^2_{12} = 7.1 \cdot 10^{-5} \text{ eV}^2, \theta_{12} = 32^\circ$$

$$\Delta m^2_{23} = 2.5 \cdot 10^{-3} \text{ eV}^2, \theta_{23} = 45^\circ$$

To be submitted
to Eur. Phys. J. C.



Conclusions

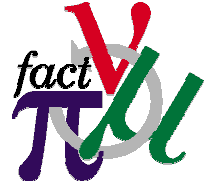

- The SPL SuperBeam would be the perfect user for a Megaton detector located in the Frejus tunnel
- The SPL SuperBeam can be very attractive to measure θ_{13} in different conditions (neutrino energy and beam contamination) than the T2K experiment
- The SPL SuperBeam + Beta Beam offer a unique opportunity for measuring CP and T violation
- Due to its design the SPL SuperBeam is the first step towards a CERN based-Neutrino Factory



Flux comparison with other experiment

