

CTF3 installations and operation schedule 2009

L. Rinolfi

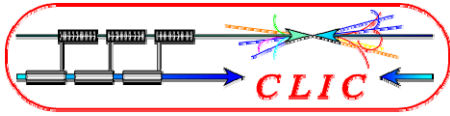

Outlook



All installations, into CTF3, have been presented in the different talks of this meeting.

Therefore the main installations, foreseen during the 2008/2009 shut-down, are briefly summarized with some photographs.

The planning and the schedule for 2009 is presented.

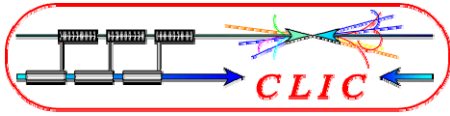

Main CTF3 installations in 2009

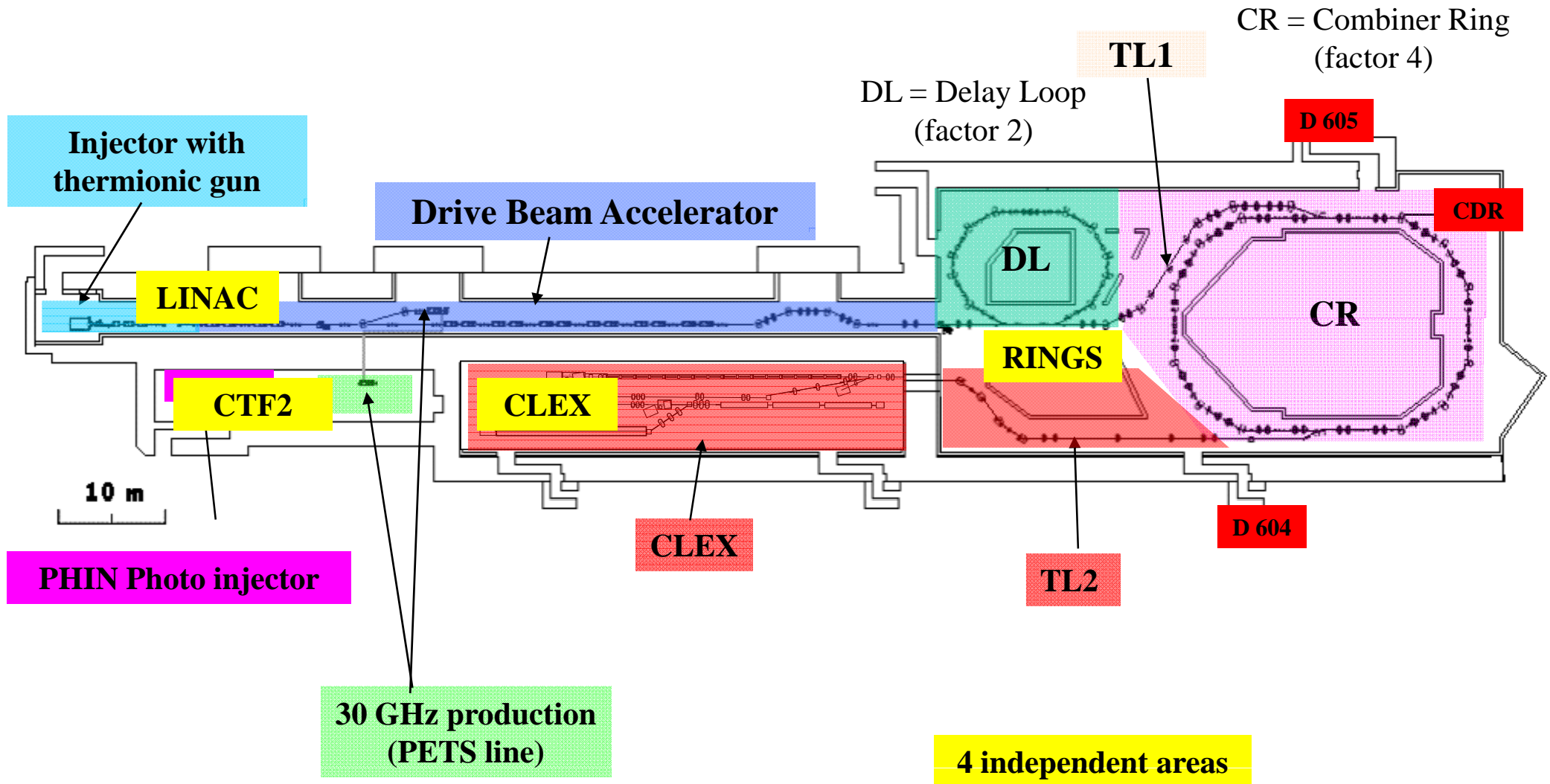

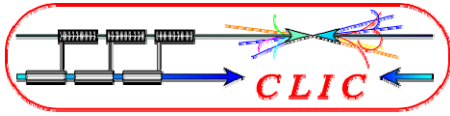

Coherent Diffraction Radiation (CDR)

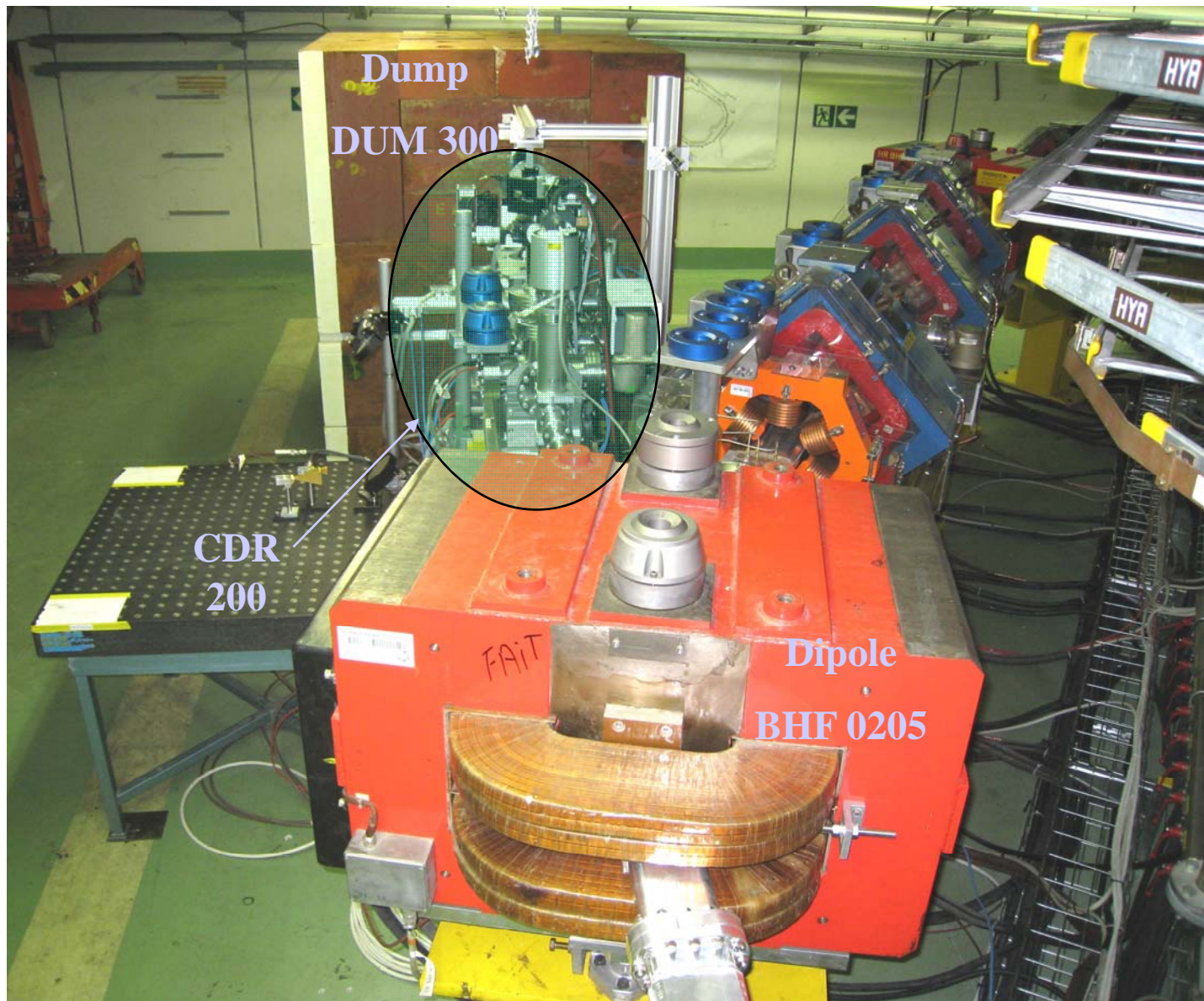

See *CRD experiment* talk
by P. Karataev



Royal Holloway
University of London

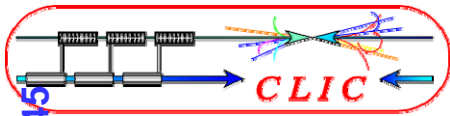

TL2 Layout

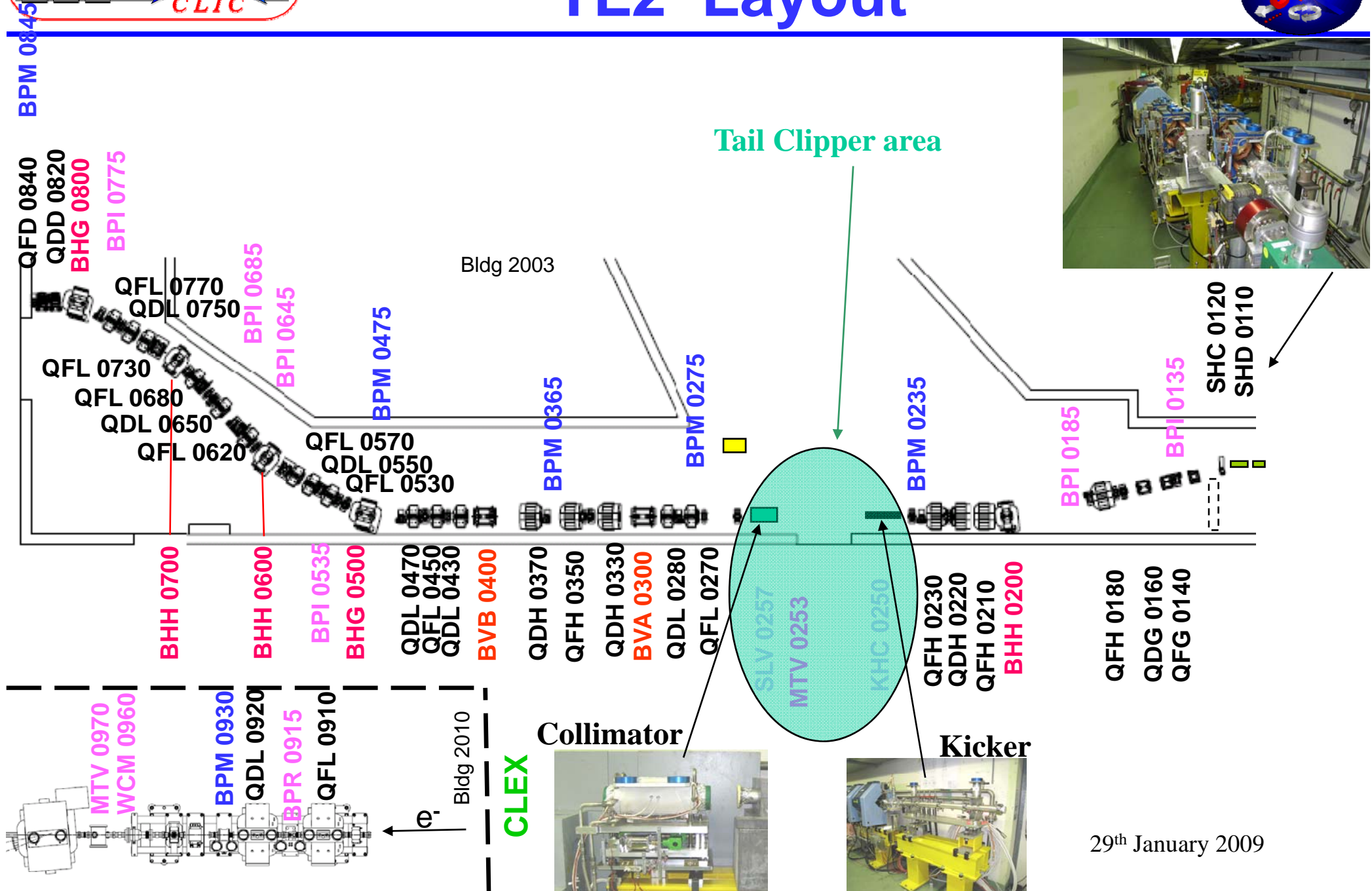

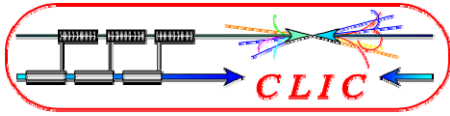

TL2 line - Tail Clipper kicker

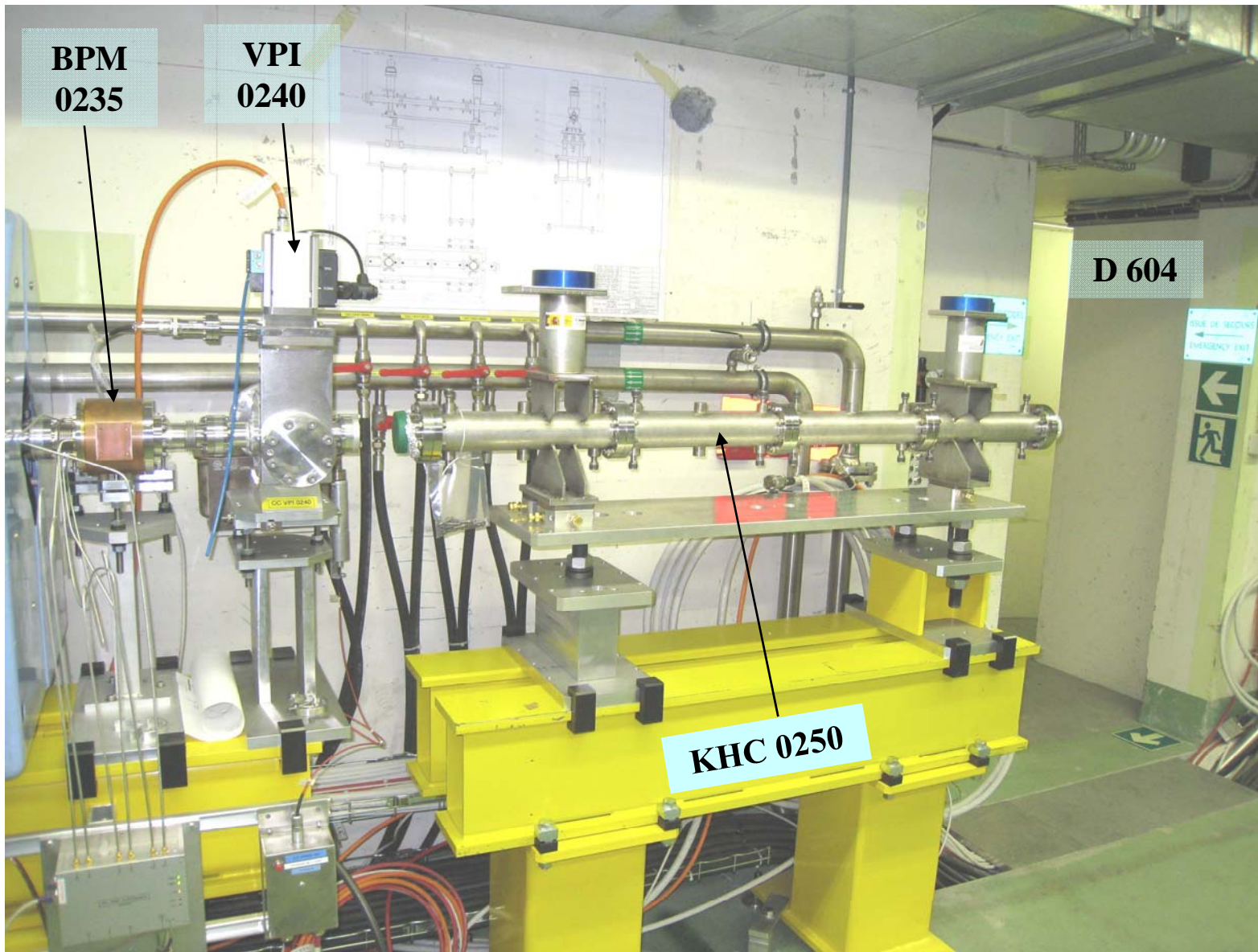

See *Tail Clipper* talk
by M. Barnes

and

Tail Clipper kicker talk
by I. Rodriguez



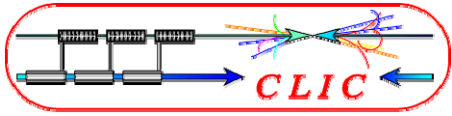

TL2 line - Tail Clipper collimator

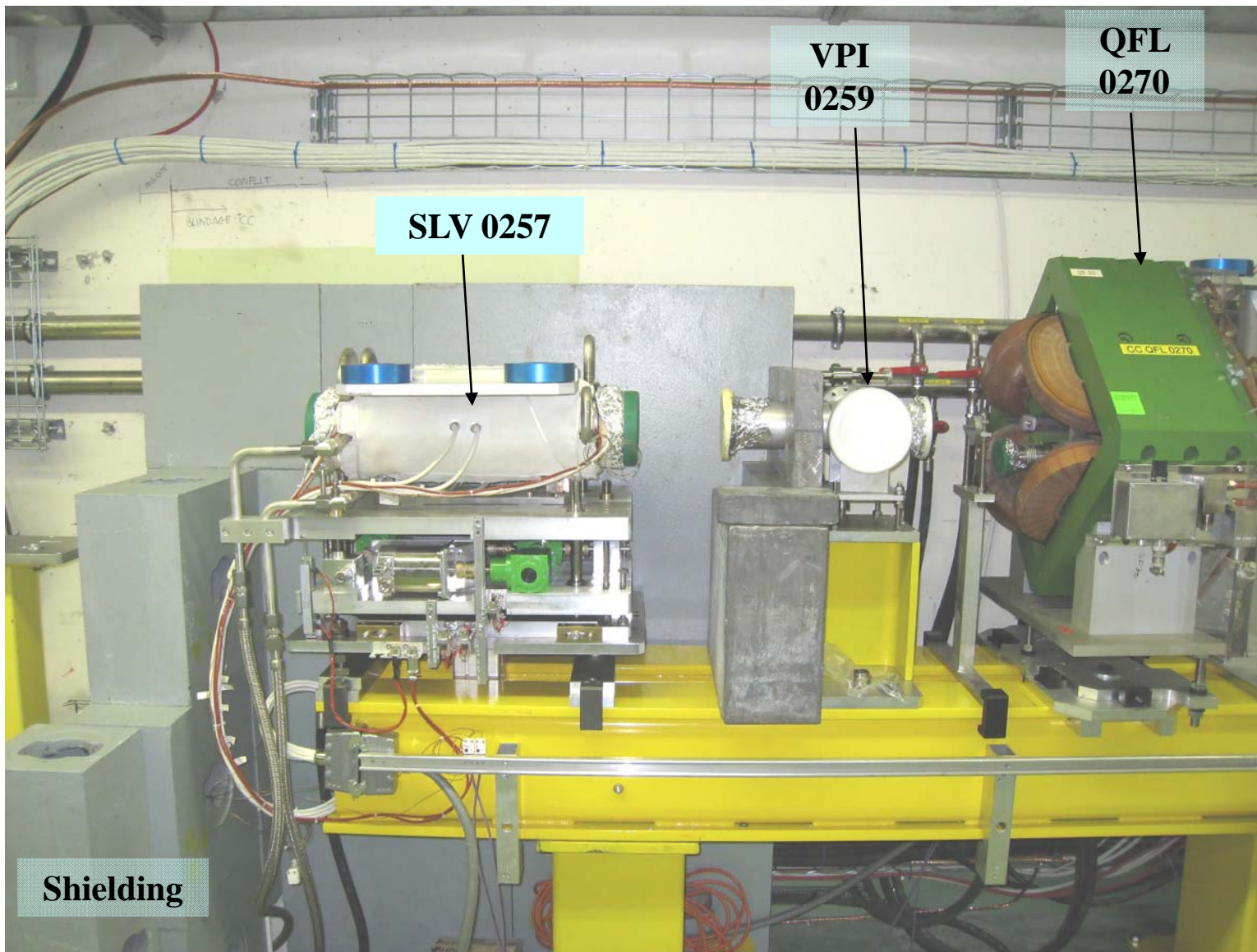

See *Tail Clipper* talk
by R. Chamizo

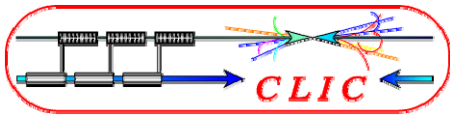

TL2 line - CC.MTV 0253



T. Lefevre



OTR screen for emittance measurement

30mm screen - 20-100 μ m spatial resolution

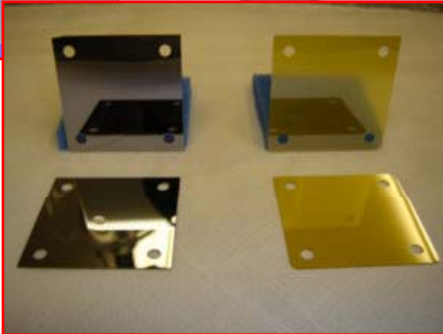
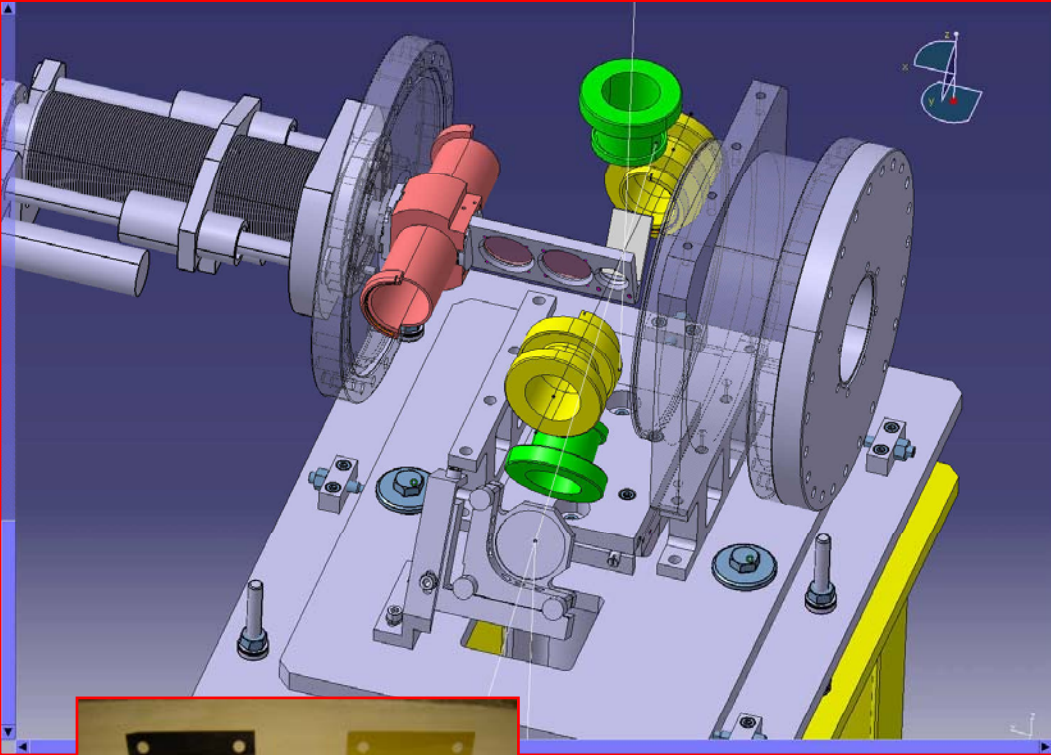
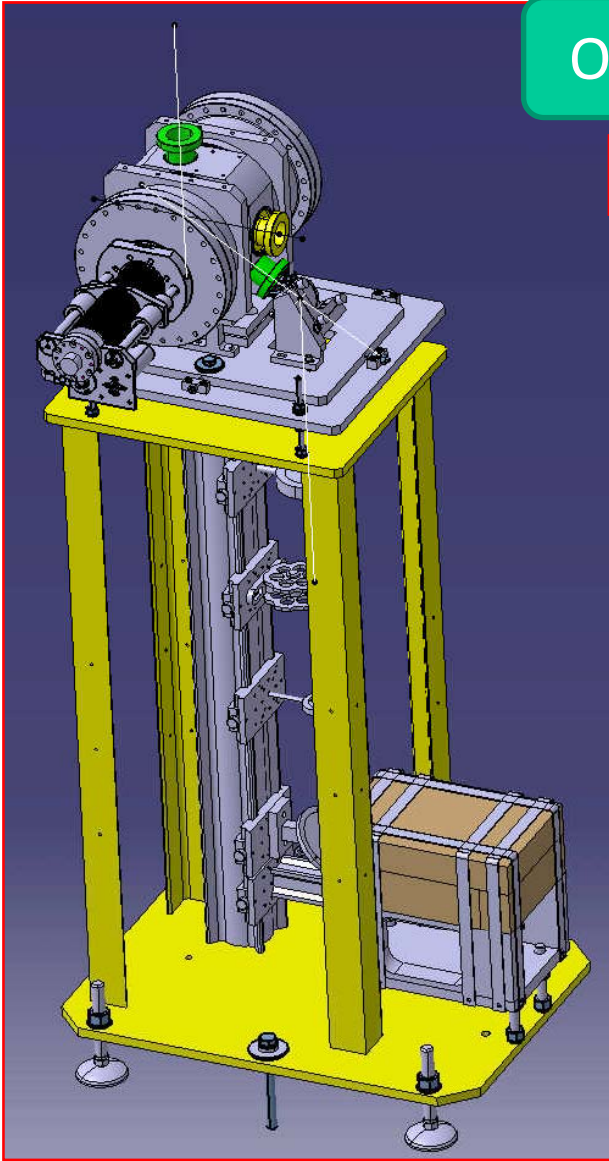

200 μ m thick mirror polished Si and CVD SiC wafer

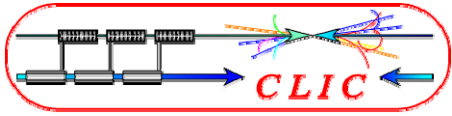

Door 605 before new chicane installation



See *Radiation monitoring*
talk

by T. Otto

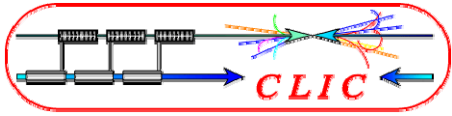

Door 604 before new chicane installation

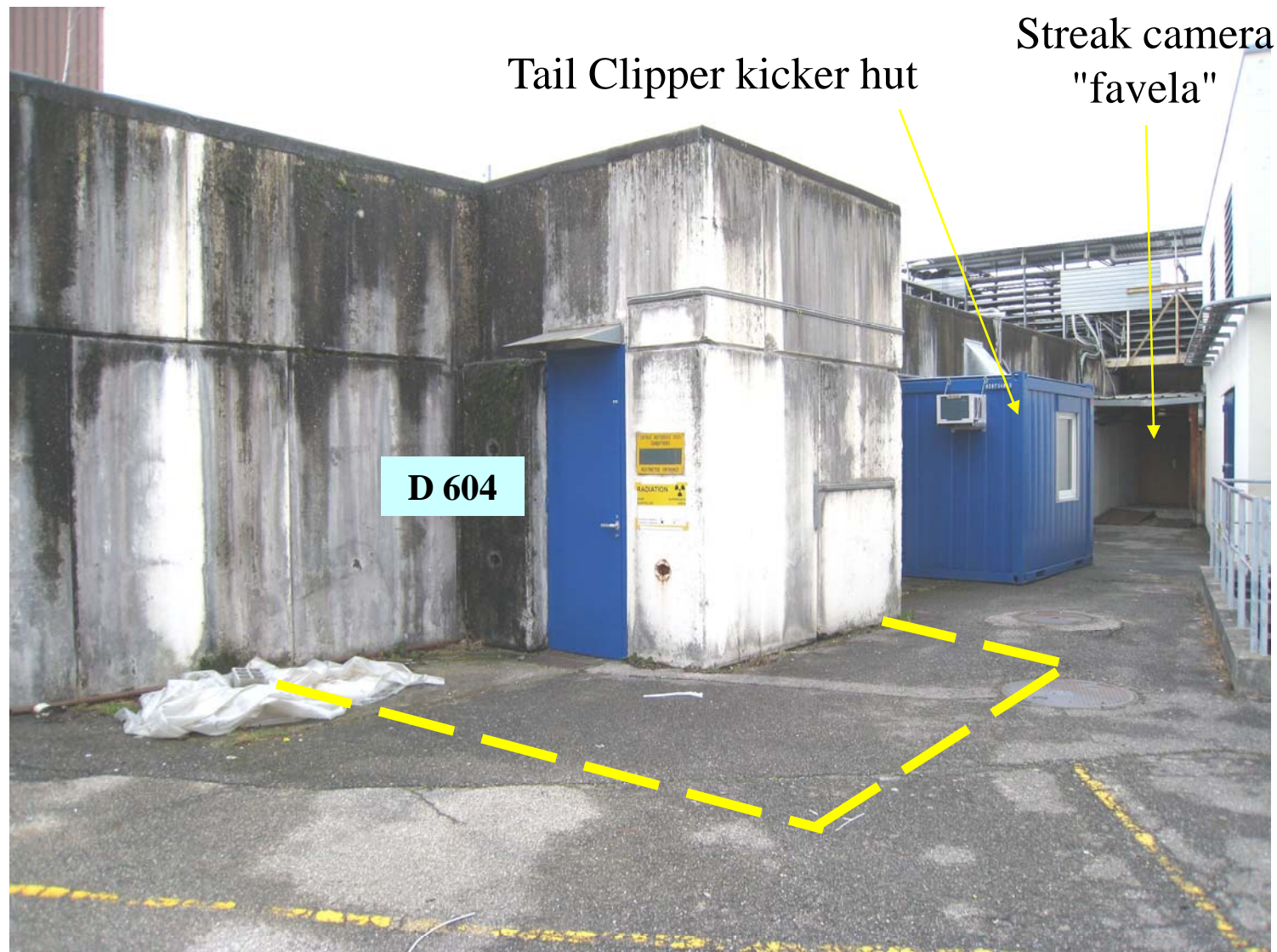

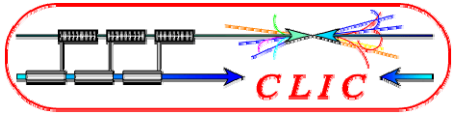

CLEX Layout

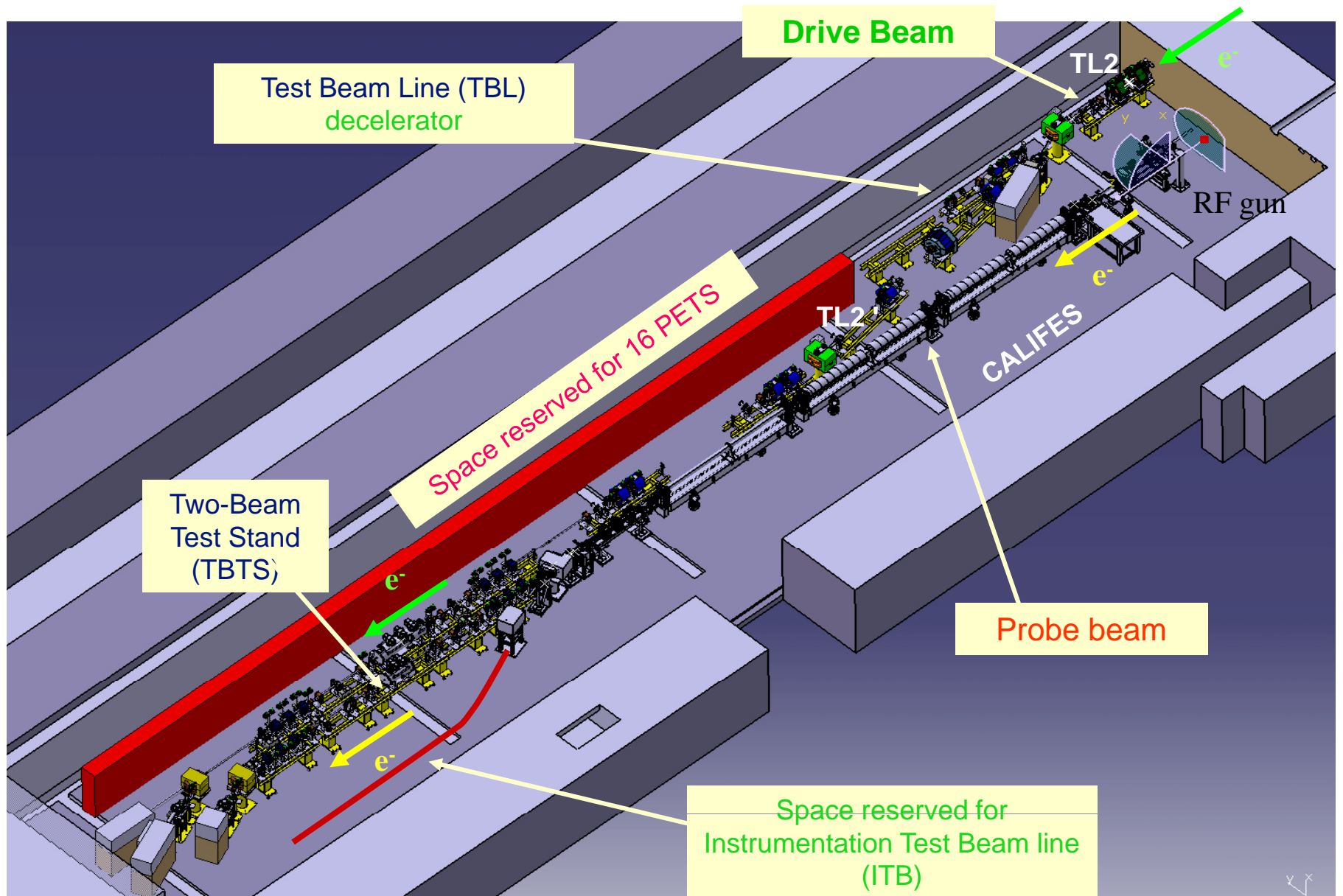

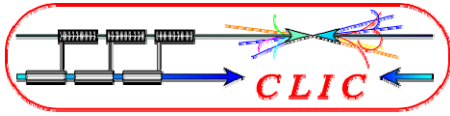

TBL layout

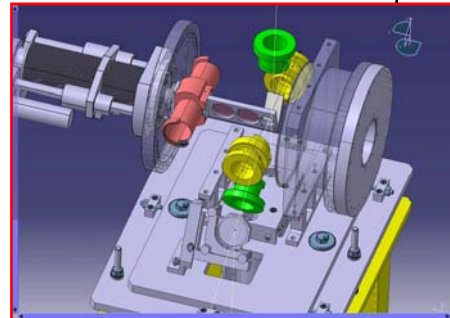
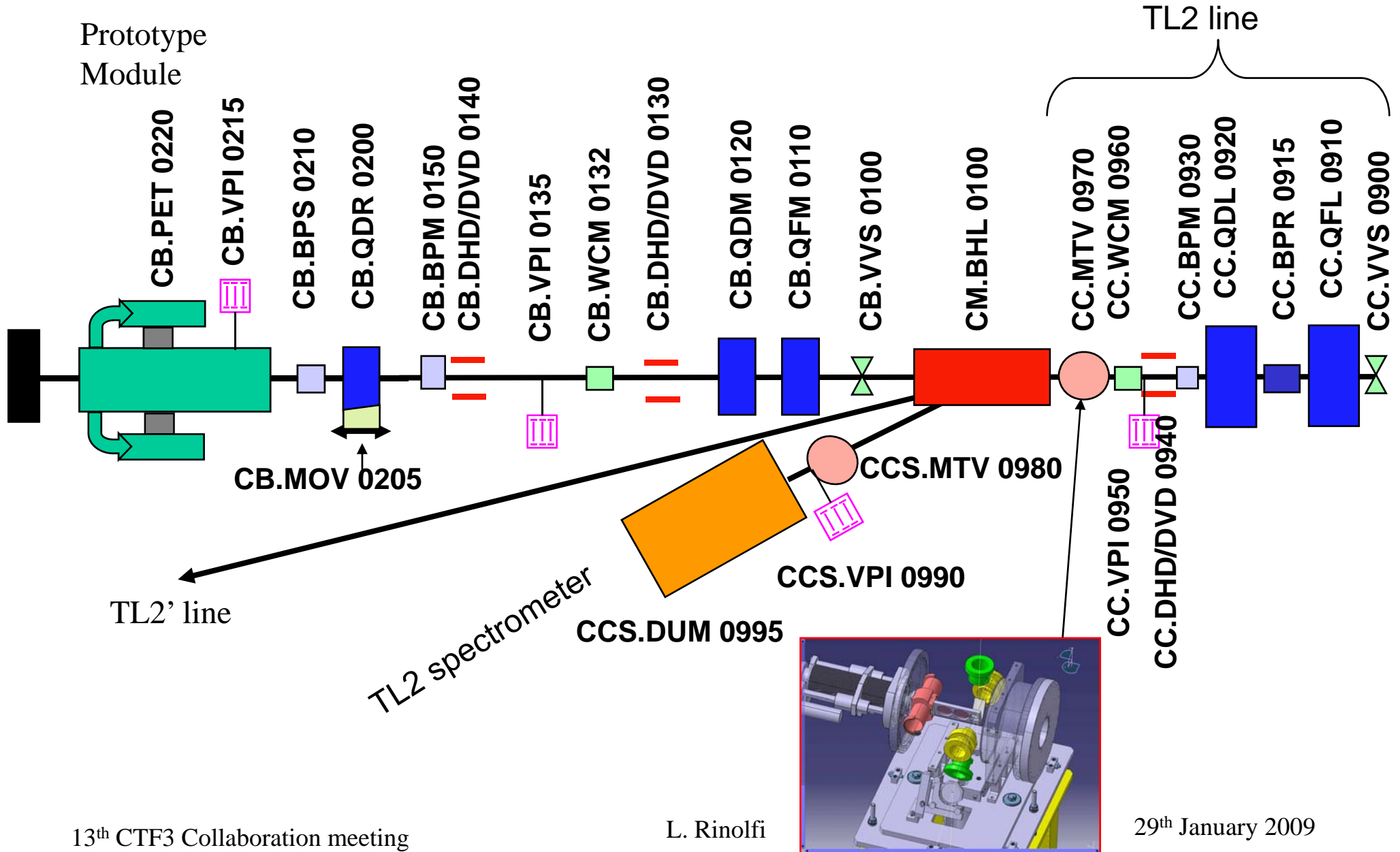

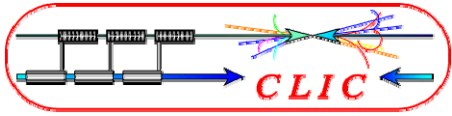

Test Beam Line (TBL) today

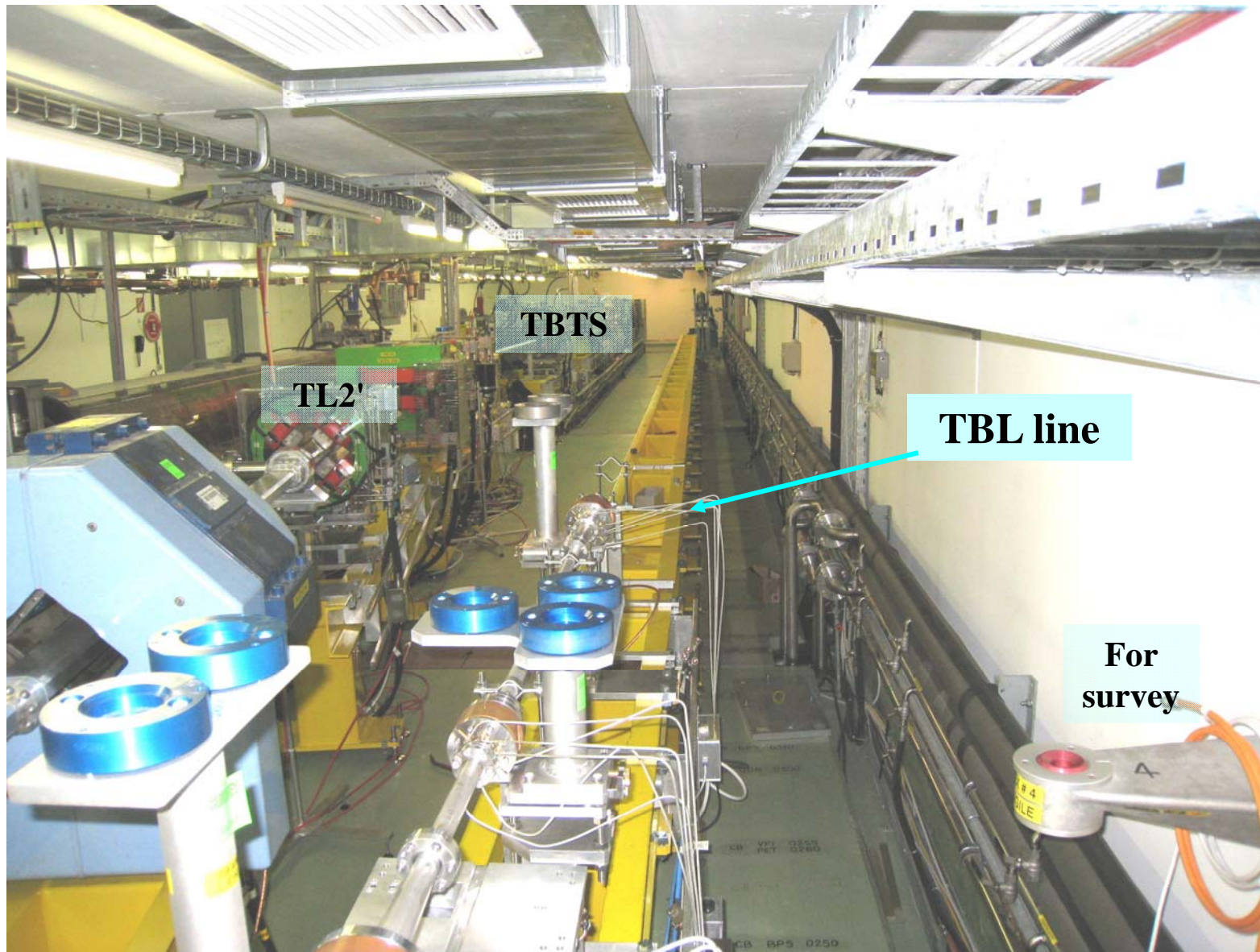

See *TBL* talks
by S. Doebert
A. Faus-Golfe
E. Toral
D. Carillo
A. Newborough

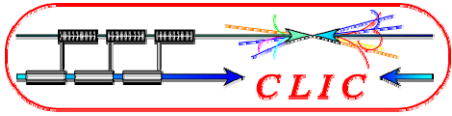

TBL girders installed

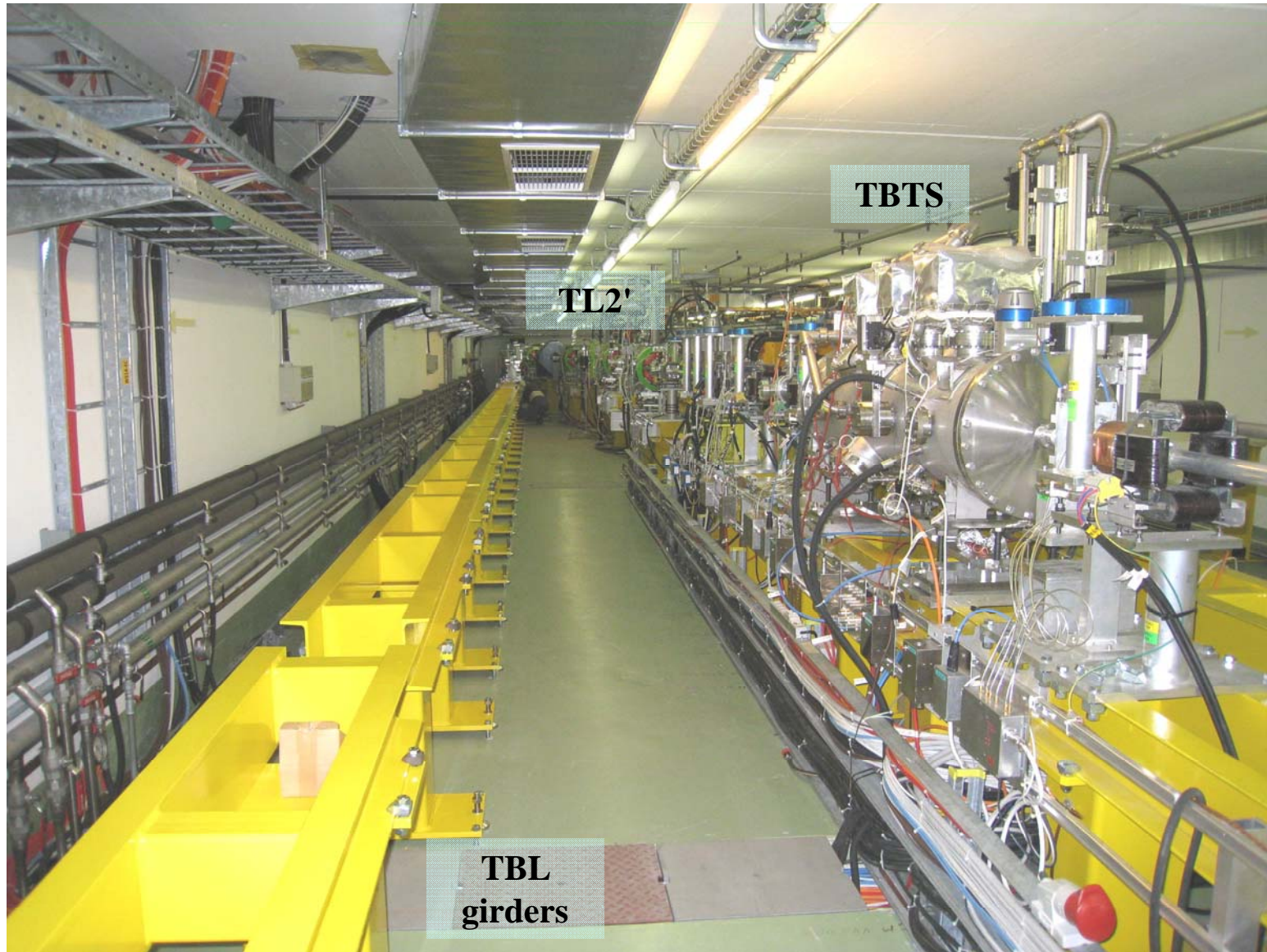

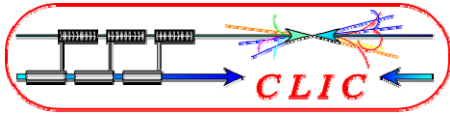

CALIFES *



See *CALIFES* talks

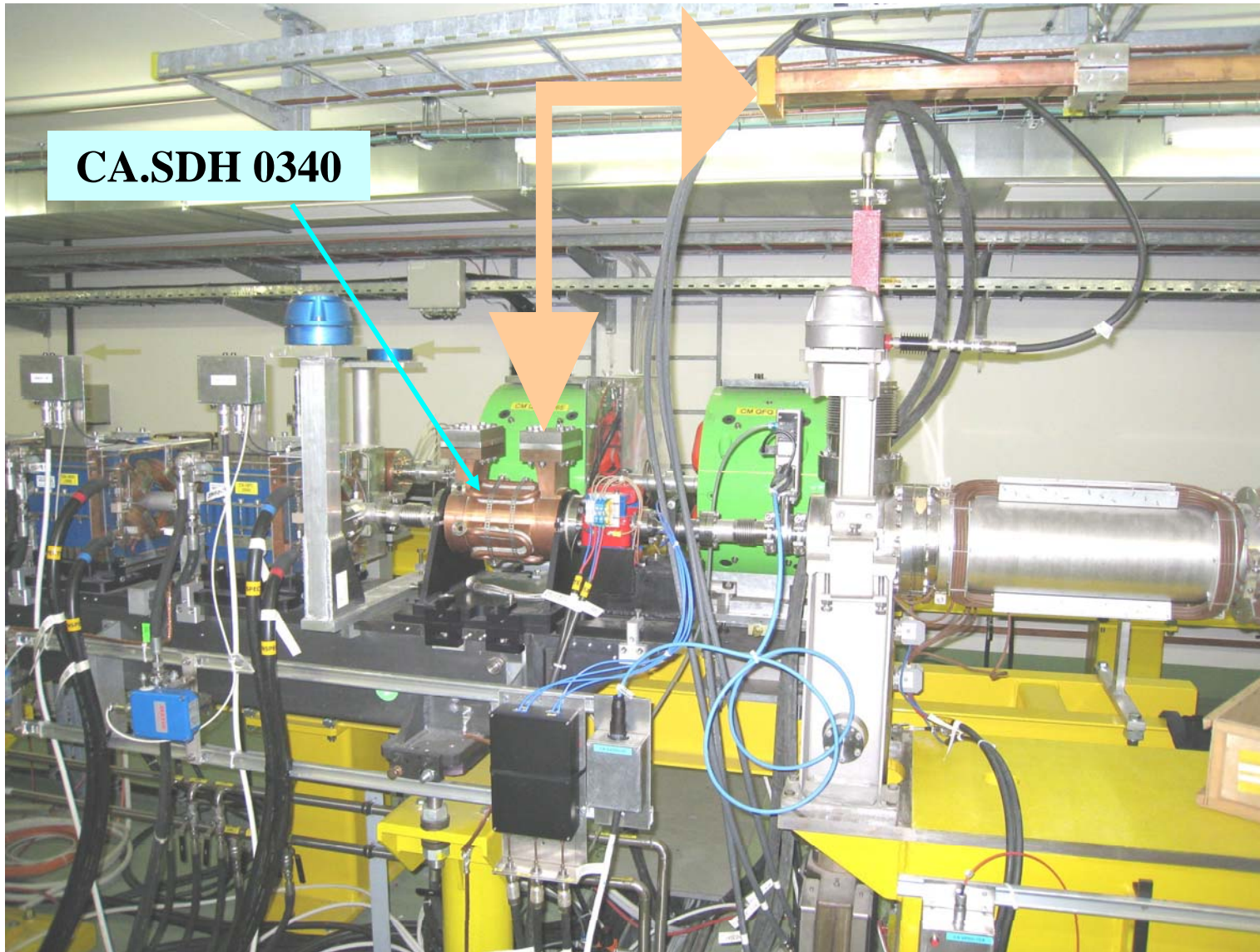

by **W. Farabolini**

F. Peauger

C. Simon

G. Cheymol

l r f u
—
cei
—
sac lay

**What
remains to
be done**

(*) CALIFES = Concept d'Accélérateur Linéaire pour Faisceau d'Electron Sonde

13th CTF3 Collaboration meeting

L. Rinolfi

29th January 2009

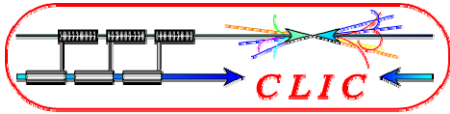

RF measurements for CALIFES



l r f u
—
cea
—
saclay

Adjustments of
RF phases for
the 3 LIL (*)
accelerating
structures of the
Probe Beam

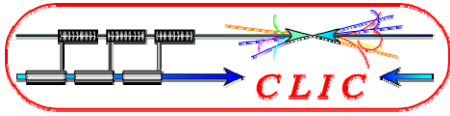

Klystrons

See *RF Power plant talk*



by G. McMonagle

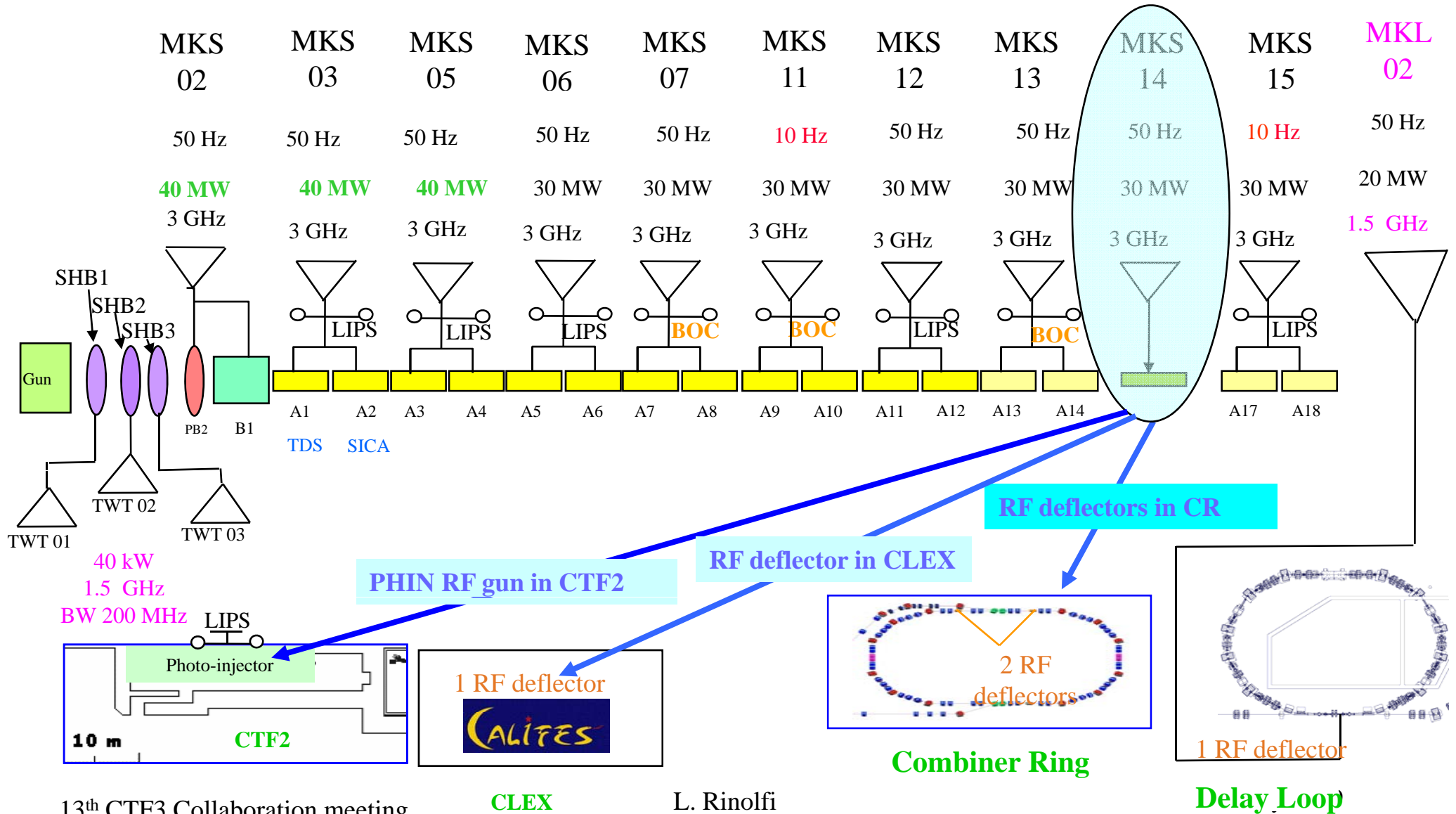

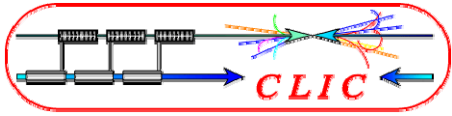

Future Instrumentation Test Beam line



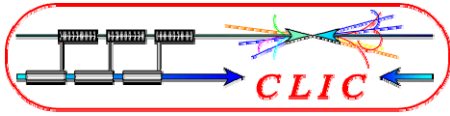

TBTS

See *TBTS* talks



Two Beam Test Stand

by R. Ruber

V. Ziemann

E. Adli

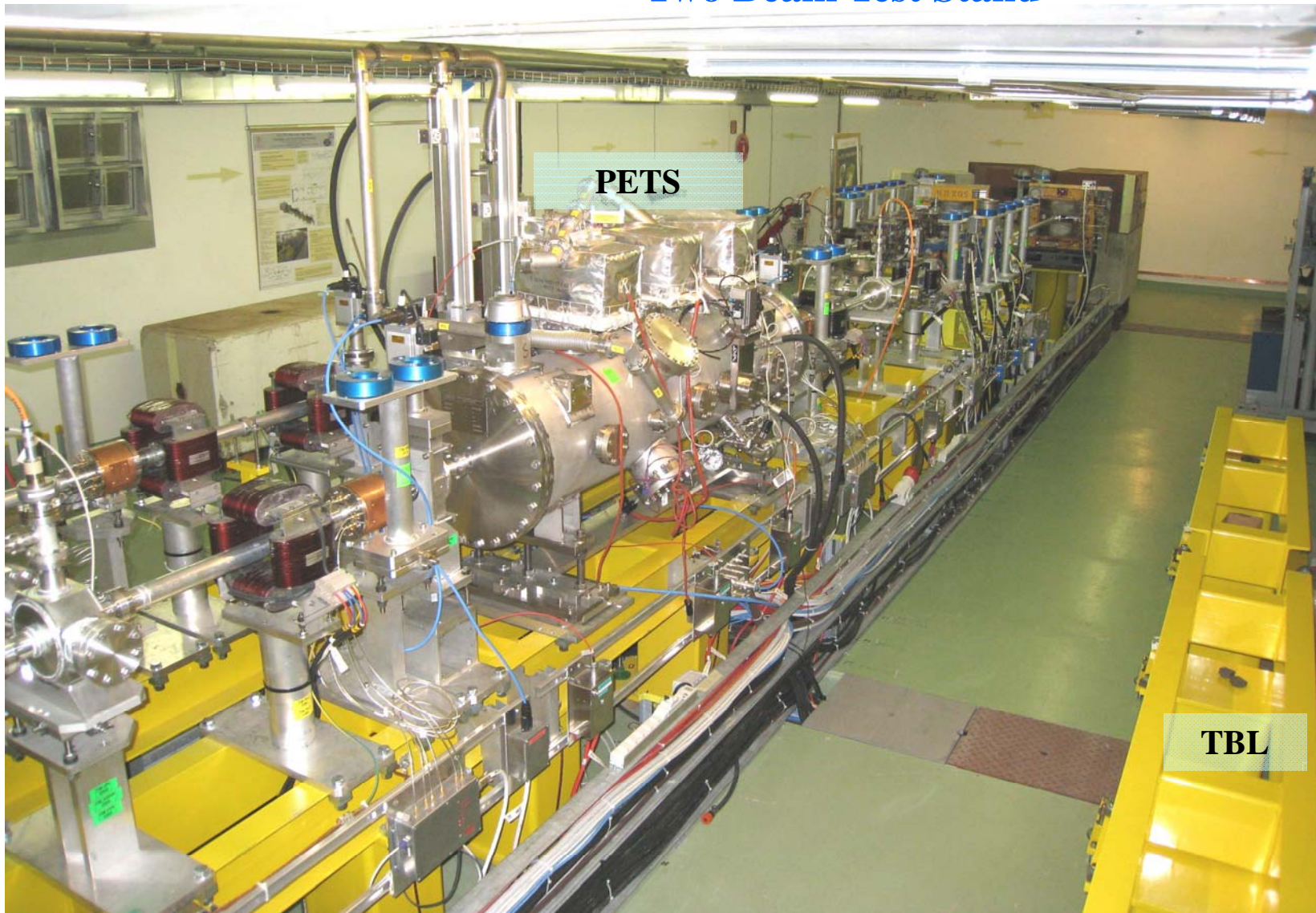

UPPSALA
UNIVERSITET

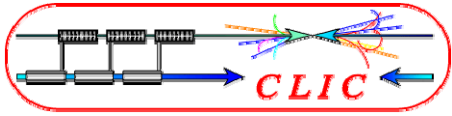

CTF 2 hall

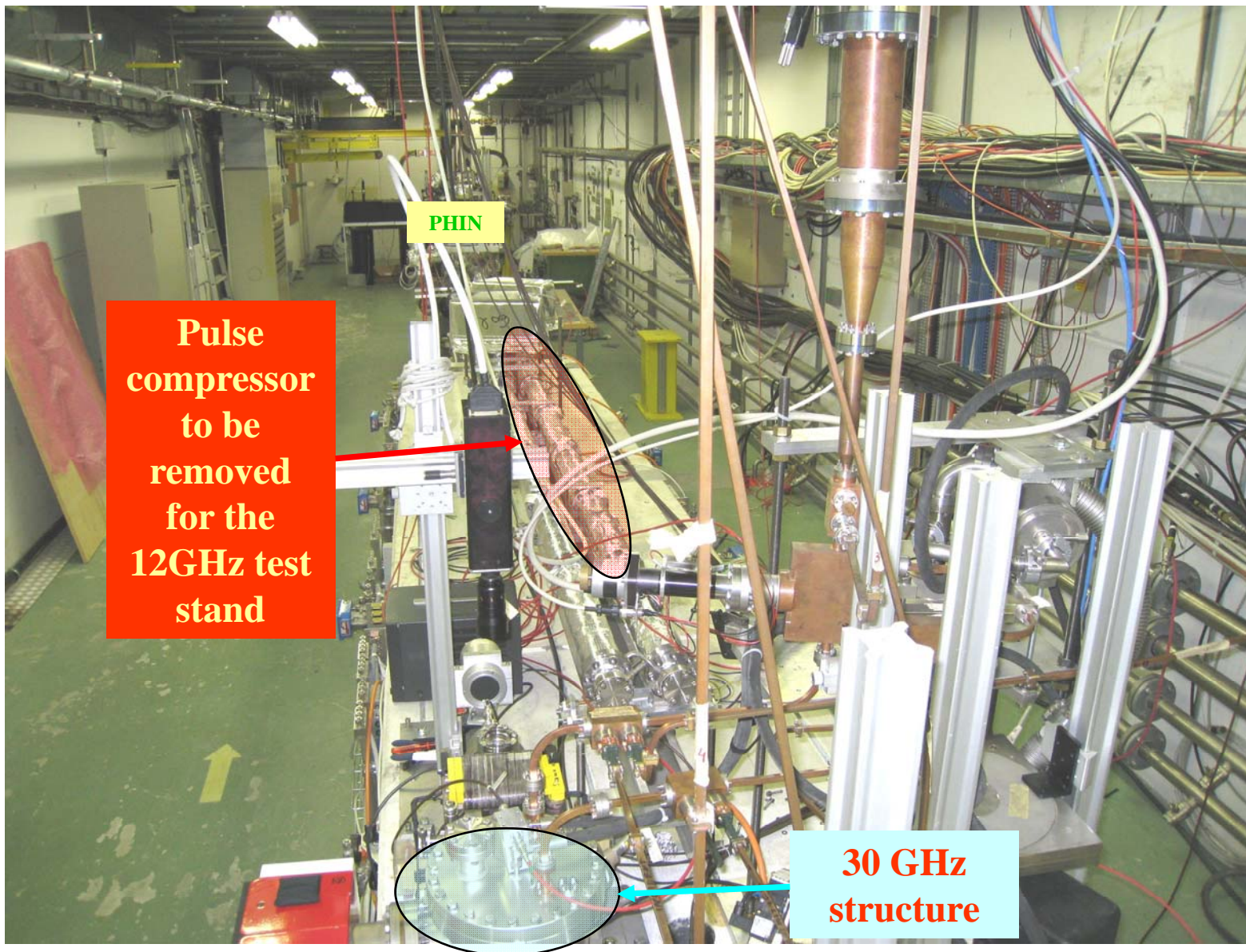

See *30 GHz results* talk
by M. Gerbaux

See *12 GHz* talk
By K. Schirm

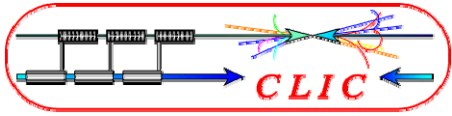
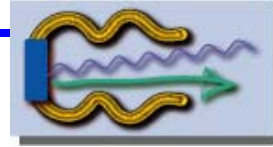

PHoto-INjector (PHIN)



See *PHIN* talks

by R. Losito

O. Mete

S. Doebert

M. Petrarca

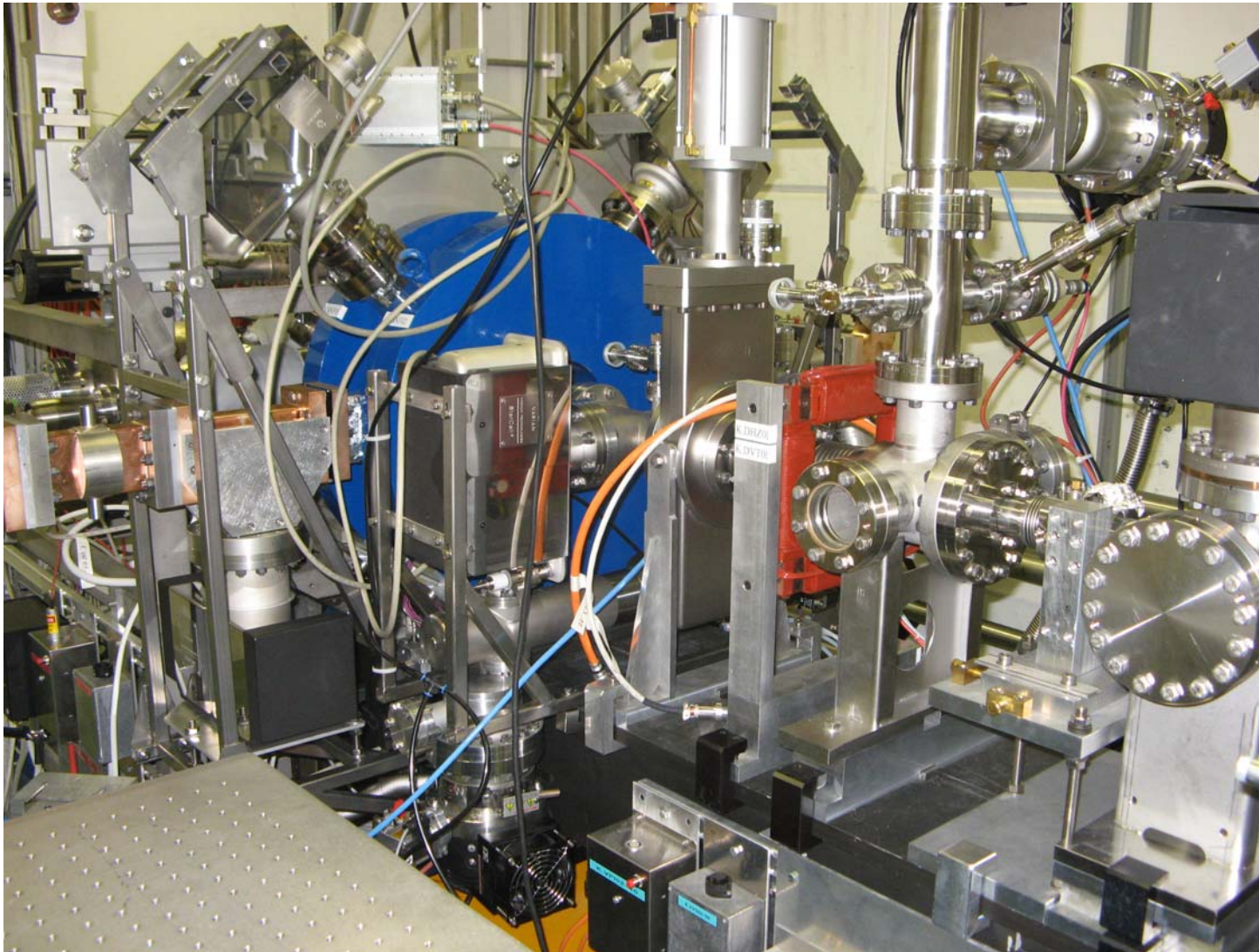

Important financial contribution from EU within FP6 program

13th CTF3 Collaboration meeting

L. Rinolfi

29th January 2009

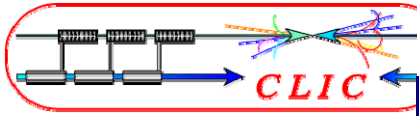

Start CTF3
23 February 09

CTF3 General Schedule for 2009

	Jan					Feb				Mar				
Wk	1	2	3	4	5	6	7	8	9	10	11	12	13	
Mo		5	12	19	26	2	9	16	23	2	9	16	23	
Tu					CTF3 Coll. meet.				Tests CO + PO + BI					
We														
Th	01/01/2009													
Fr	Installation TL2 (Tail Clipper) + CALIFES + TBTS + TBL													
Sa														
Su														

	Apr				May					Jun					
Wk	14	15	16	17	18	19	20	21	22	23	24	25	26		
Mo	30	6	Eastr	13	20	27	4	11	18	25	Whit.	1	8	15	22
Tu															
We															
Th								Ascen							
Fr		G. Frid			1 st May										
Sa															
Su															

	Jul				Aug					Sep			
Wk	27	28	29	30	31	32	33	34	35	36	37	38	39
Mo	29	6	13	20	27	3	10	17	24	31	7	14	21
Tu													
We													
Th												Jeune G.	
Fr													
Sa													
Su													

	Oct				Nov					Dec			
Wk	40	41	42	43	44	45	46	47	48	49	50	51	52
Mo	28	5	12	19	26	2	9	16	23	30	7	14	21
Tu													
We			CLIC work shop										CTF3 SHUTDOWN
Th													
Fr													Xmas.
Sa													
Su													

CTF3 closed for Hardware tests
 CTF3 closed for RF conditioning
 CTF3 with beam
 Machine open

End CTF3
14 December 09

29th January 2009

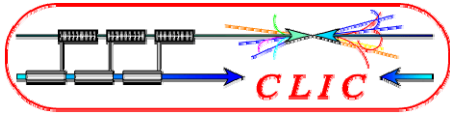

CTF3 Planning shut-down 2008/2009



J. Monteiro

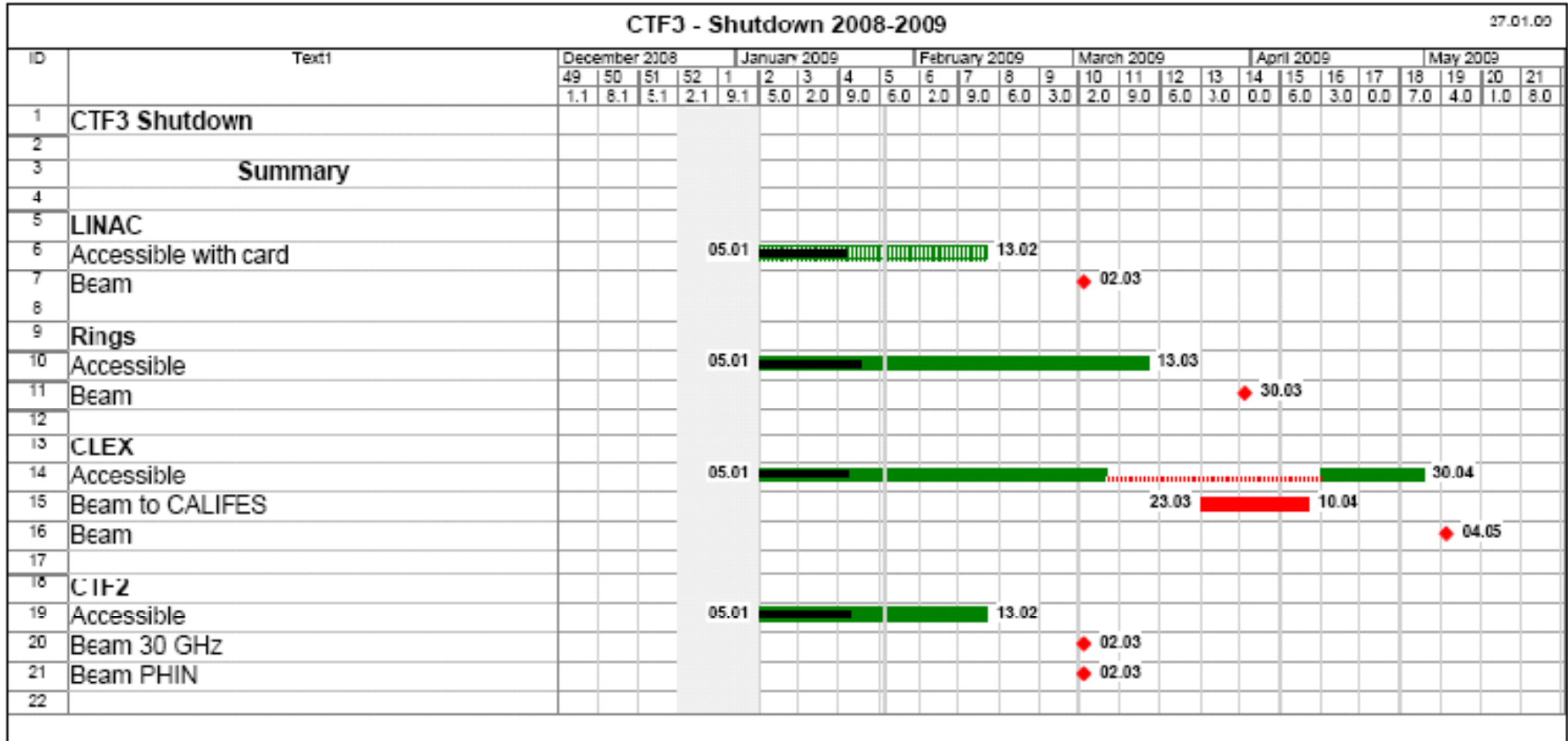

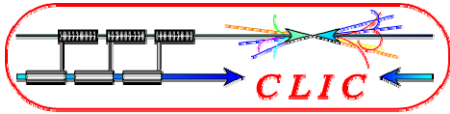

2009 Schedule for the CTF3 Linac

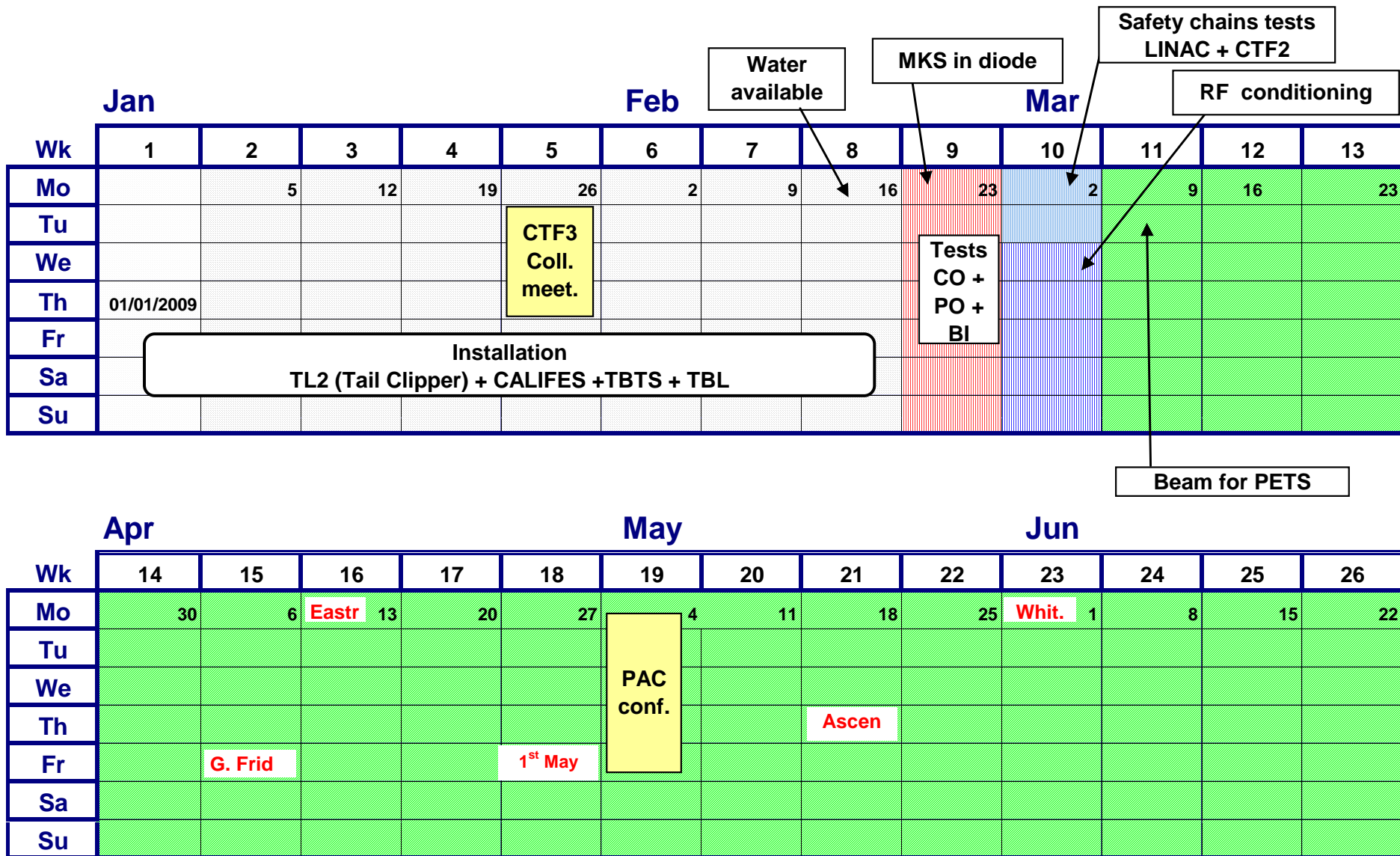

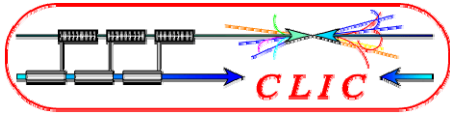

2009 Schedule for the CTF3 Rings

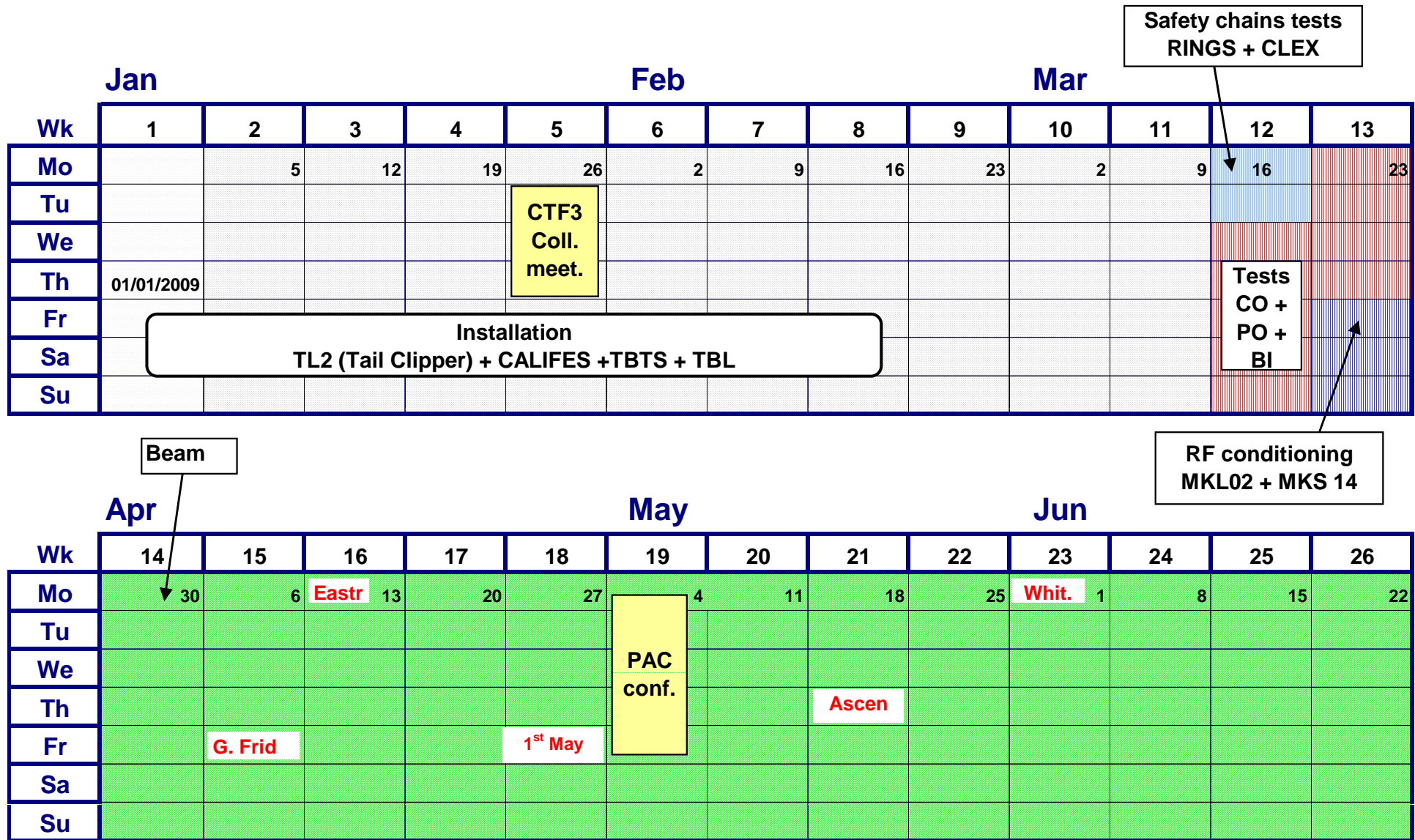

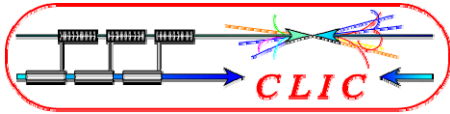

2009 Schedule for the CTF3 - CTF2

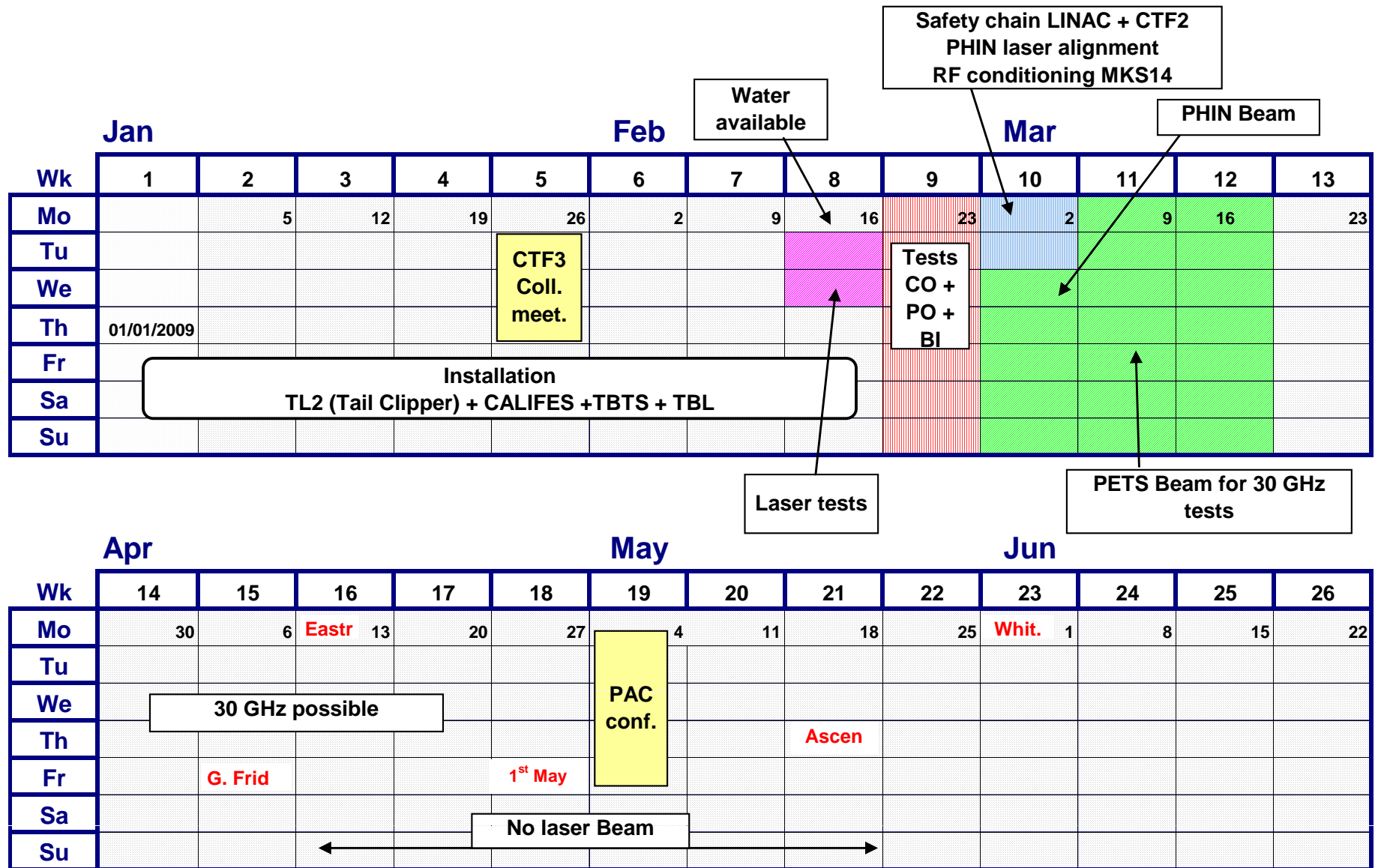

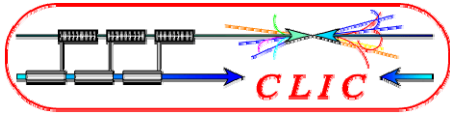

2009 Schedule for the CTF3 - CLEX

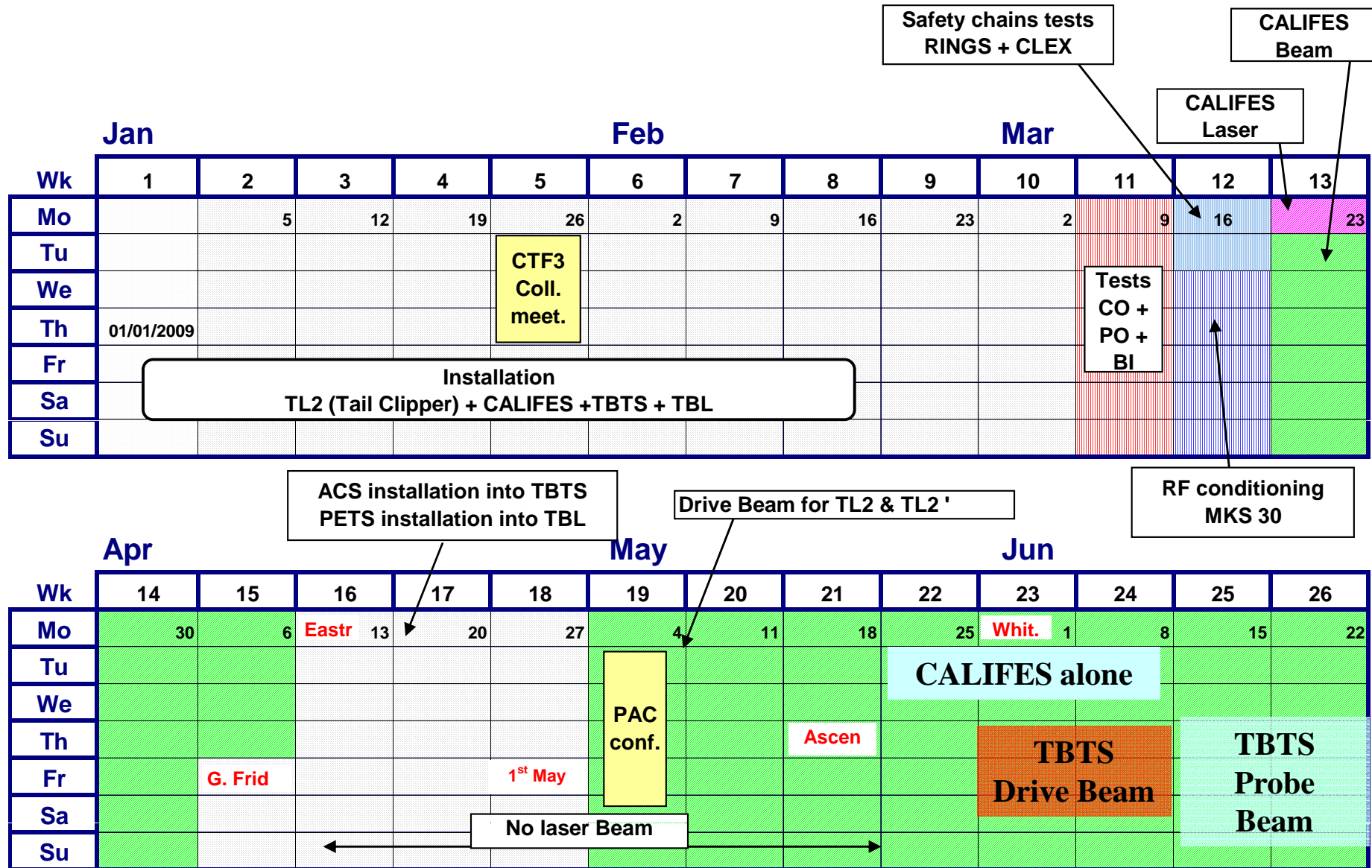

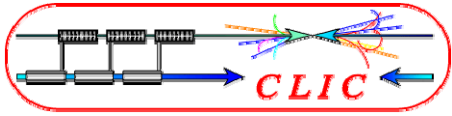

CTF 3 Control Room today ...



**But all new
consoles, new
cables, new carpet,
....
will be installed for
the 2009 start-up**

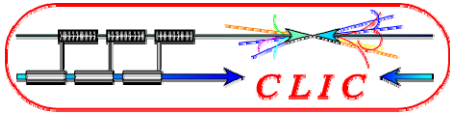

Conclusion



In 2009, all CTF3 installations will be completed and will be used to write the **CLIC CDR**



A CLIC Show Room already exist

Also a visit itinerary!!!



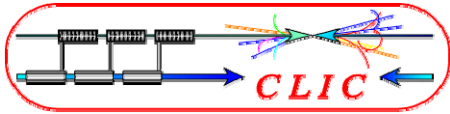

Thanks to all CTF3 collaborators



(for construction and installations)

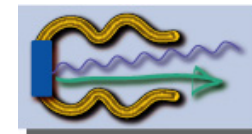
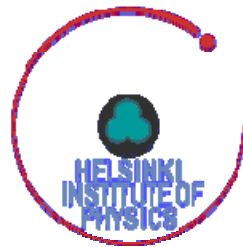

PHIN