



INTC-P-475

Penning-trap mass measurements of Zn and Cu isotopes relevant for the astrophysical *rp*-process

Spokepersons: Dinko Atanasov and Anu Kankainen

Local contact: Dinko Atanasov

29 June 2016

Physics Motivation

Measurement techniques

Beam time request





Type I X-ray burst

- Very frequent & bright phenomena
- Burst output - typically 10^{39} ergs/s. (duration 10s – 200s)
- H/He-rich acceting material
- Thermonuclear runaway leads to nucleosynthesis (*rp*-process)

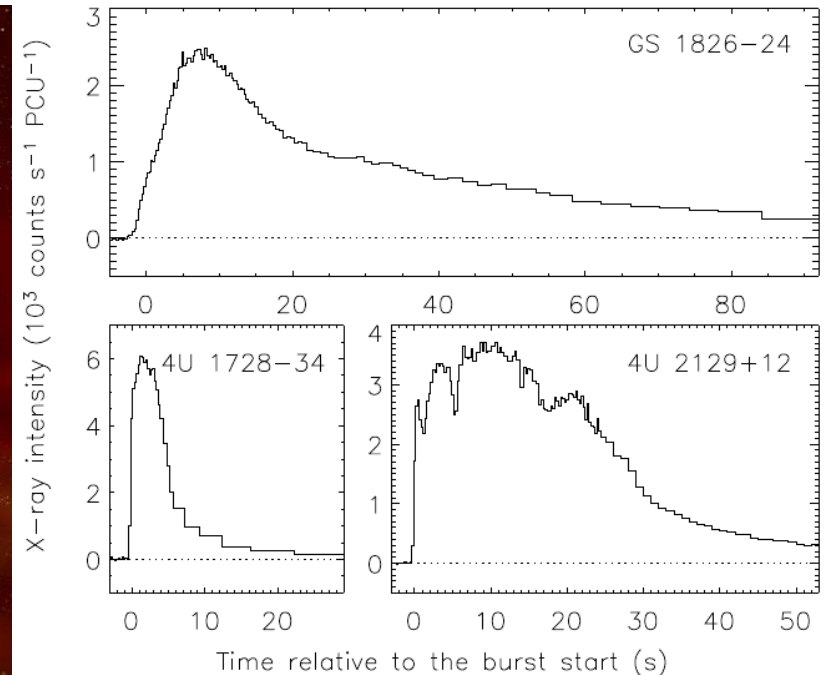
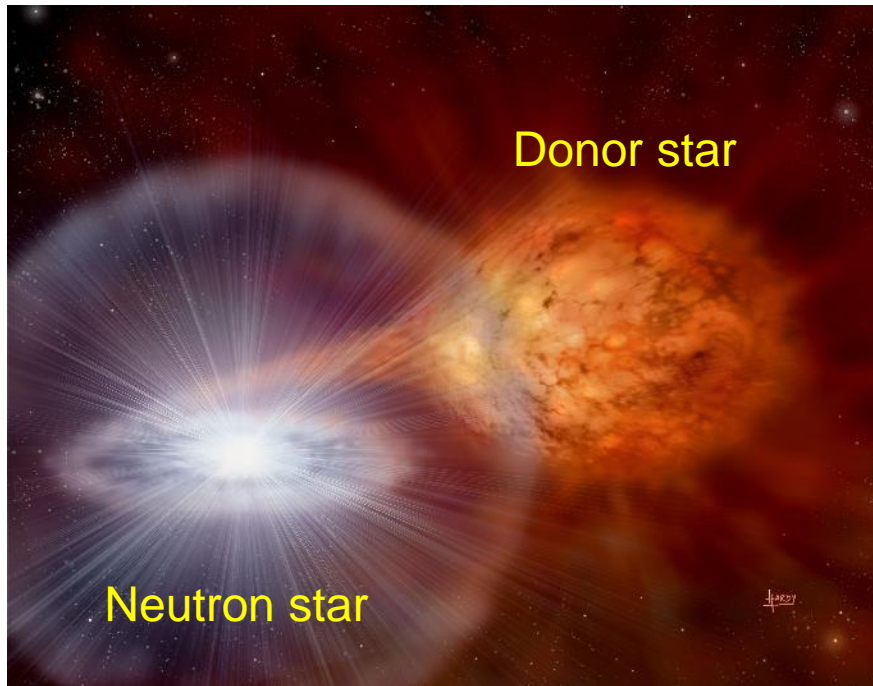



rp-process path

^{56}Ni - Long electron capture lifetime ($\sim 10^4\text{s}$) blocks exit channel

$^{56}\text{Ni}(p,\gamma)-(\gamma,p)^{57}\text{Cu}$ equilibrium

$^{57}\text{Cu}(p,\gamma)^{58}\text{Zn}$ rate has been experimentally constrained

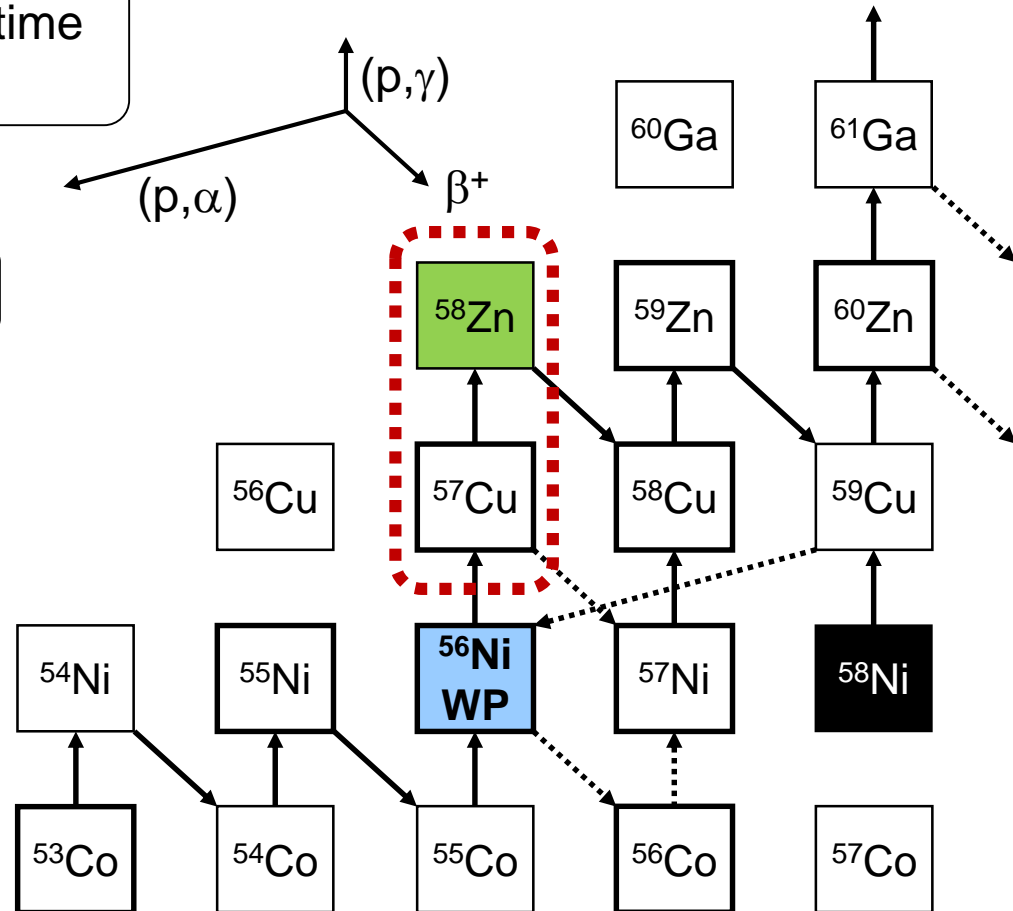

H. Schatz et al., Phys. Rev. Lett. **86**, 3471 (2001).
A. Kankainen et al., Phys. Rev. C **82**, 052501(R) (2010)
C. Langer and Montes et al. (2014) PhRvL 113 032502



Reaction rate - calculations

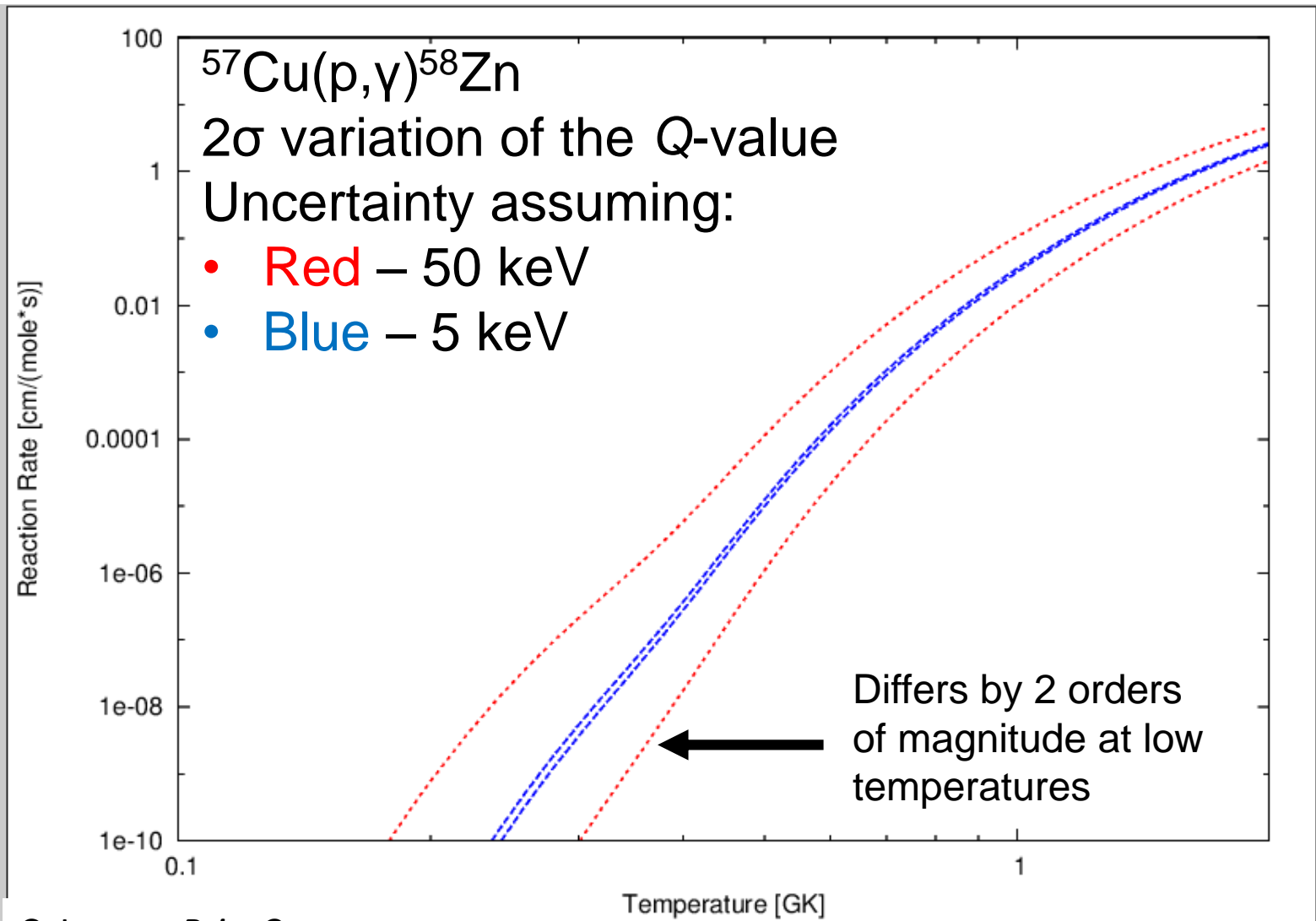

C. Langer *Priv. Comm.*



rp-process path

Alternative flow through
the reaction rate $^{55}\text{Ni}(p,\gamma)^{56}\text{Cu}$
~40% branching

Resonance energy:
 $E_r = E_x - Q$

$$Q = m(\text{H}) + m(^{55}\text{Ni}) - m(^{56}\text{Cu})$$

AME2012

$ME(^{56}\text{Cu}) = -38\,238(196)$ keV

Indirect Estimation:

$ME(^{56}\text{Cu}) = -38\,697(88)$ keV

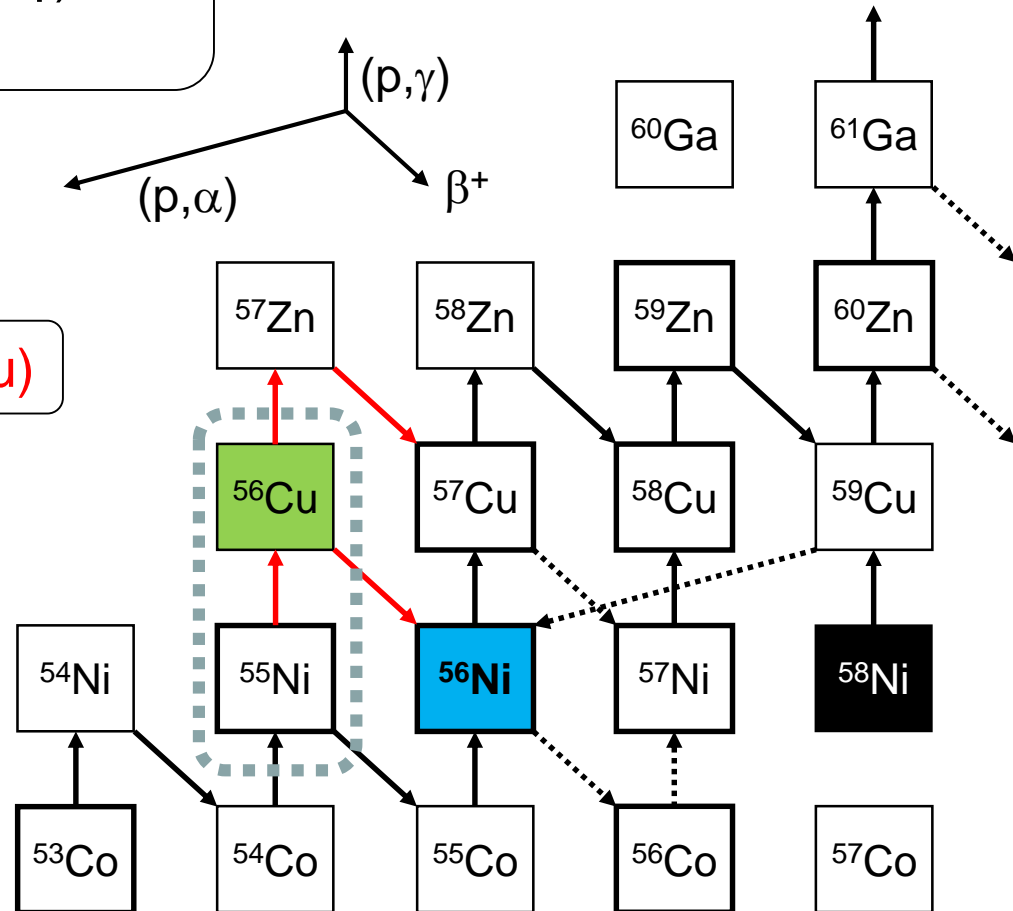



Measurement Technique

Time-Of-Flight Ion-Cyclotron Resonance

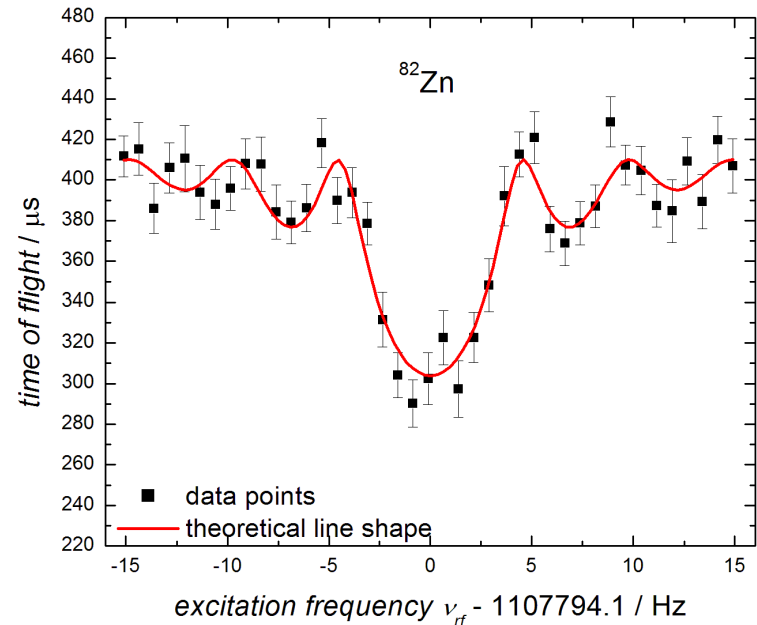
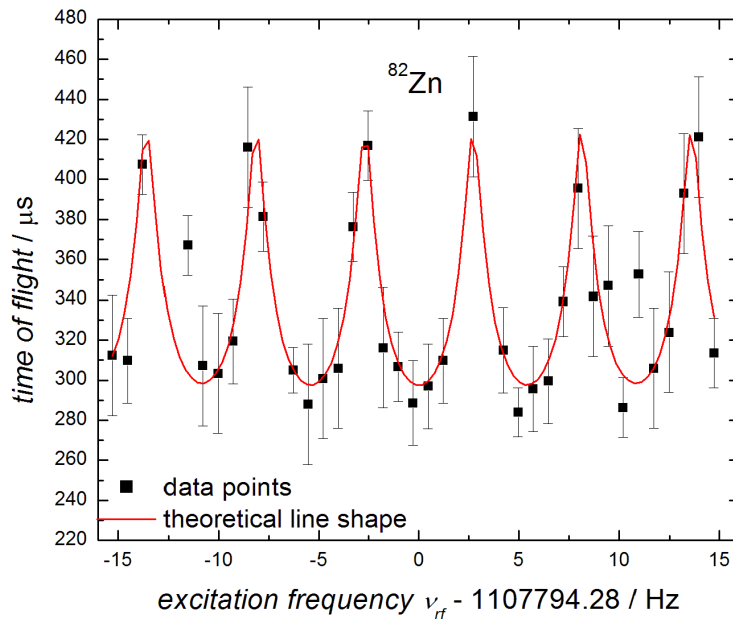

$$\nu_c = \frac{1}{2\pi} \frac{q}{m} B$$

TOF-ICR 200ms	Excitation	Ramsey 20-160-20ms
195 minutes	Duration	35 minutes
580	Ion count	75
$1 \cdot 10^{-7}$	Rel. Uncertainty	$8 \cdot 10^{-8}$



Measurement Technique

Multi-Reflection Time-of-Flight Mass Spectrometry

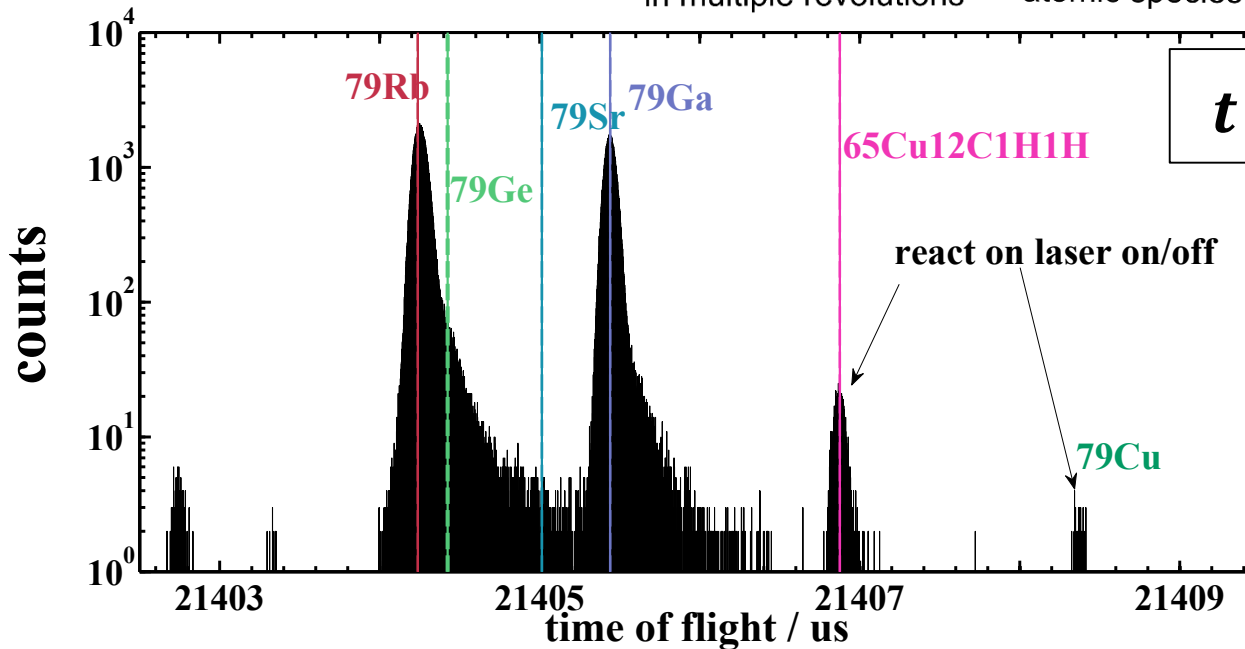
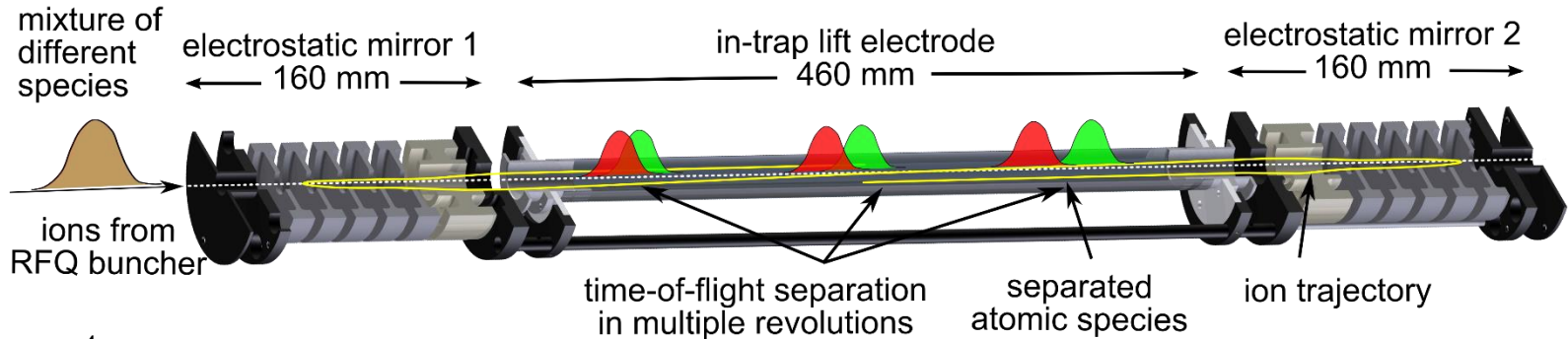

$$t = a \cdot \sqrt{m/q} + b$$





Yield expectations

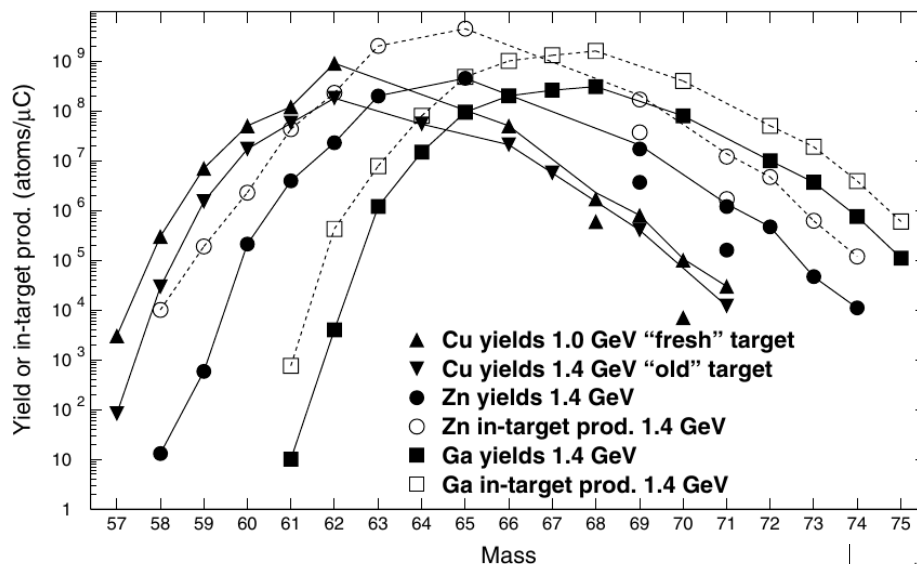

- ZrO_2 felt target
- Release of Cu is about 1s
- Surface-ionized Fe, Ga from ion-source

Yield of ^{56}Cu

Estimates are based on
 ^{57}Cu (3×10^3 ions/ μC)

Yield of ^{58}Zn

10 ions/ μC

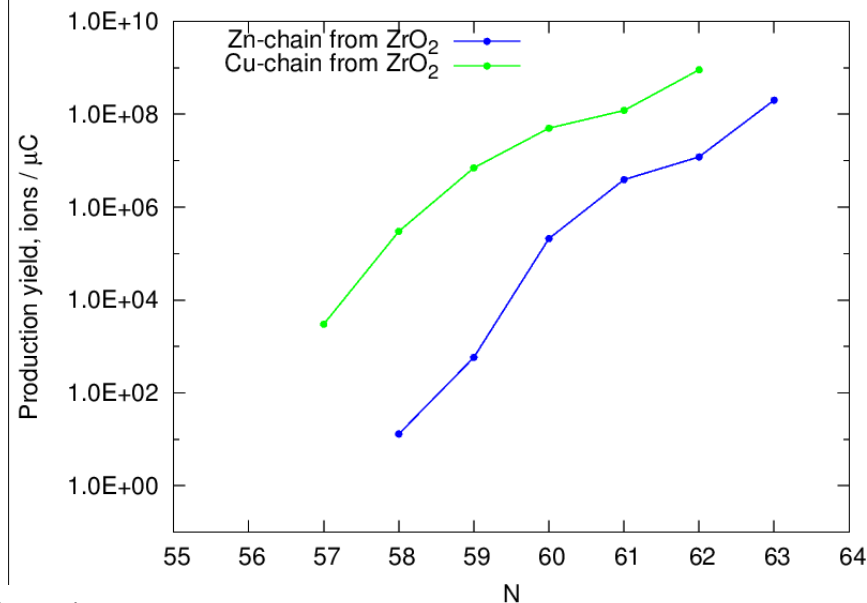



Beam time Request

Isotope	Half-life (ms)	Mass uncertainty (keV)	Target	Yield (ions/ μC)	Ion source	Shifts
^{56}Cu	93(6)	extrapolated	ZrO_2	$10^0 - 10^1$	RILIS	2+4
^{58}Zn	86.7(24)	50		10		2+4

- **Low resolving power:** required for separating Fe, Ni ($m/\Delta m \approx 3000$)
- **MR-TOF separator:** up to 10^4 contamination suppression with 10^5 resolving power in 30 ms.
- **Precision Penning trap:** Resolving contamination (CaO) require about 2×10^5 mass resolving power



Thank you for your attention

D. Atanasov , K. Blaum, S. George , F. Herfurth , A. Herlert, D. Lunney, Yu. A. Litvinov,
A. Kankainen, V. Manea, M. Mougeot, D. Neidherr, C. Langer, M. Rosenbusch,
L. Schweikhard, F. Wienholtz, R. N. Wolf, A. Welker, and K. Zuber



<http://isoltrap.web.cern.ch>



ERNST MORITZ ARNDT
UNIVERSITÄT GREIFSWALD

