

Upgrade scenario for the LHC complex

Lyn Evans

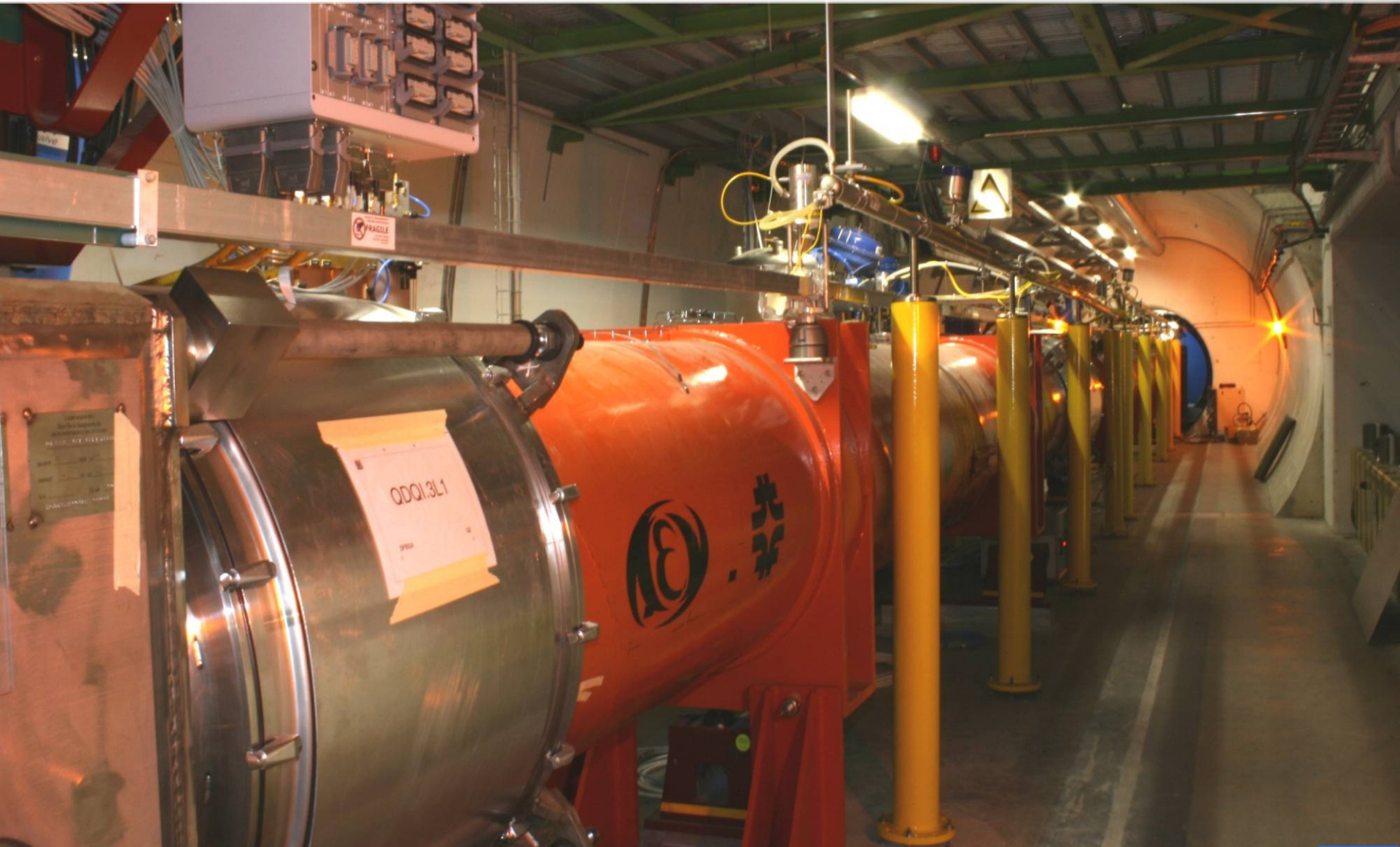

sLHC Seminar, CERN 8th June 2009



Tevatron luminosity evolution

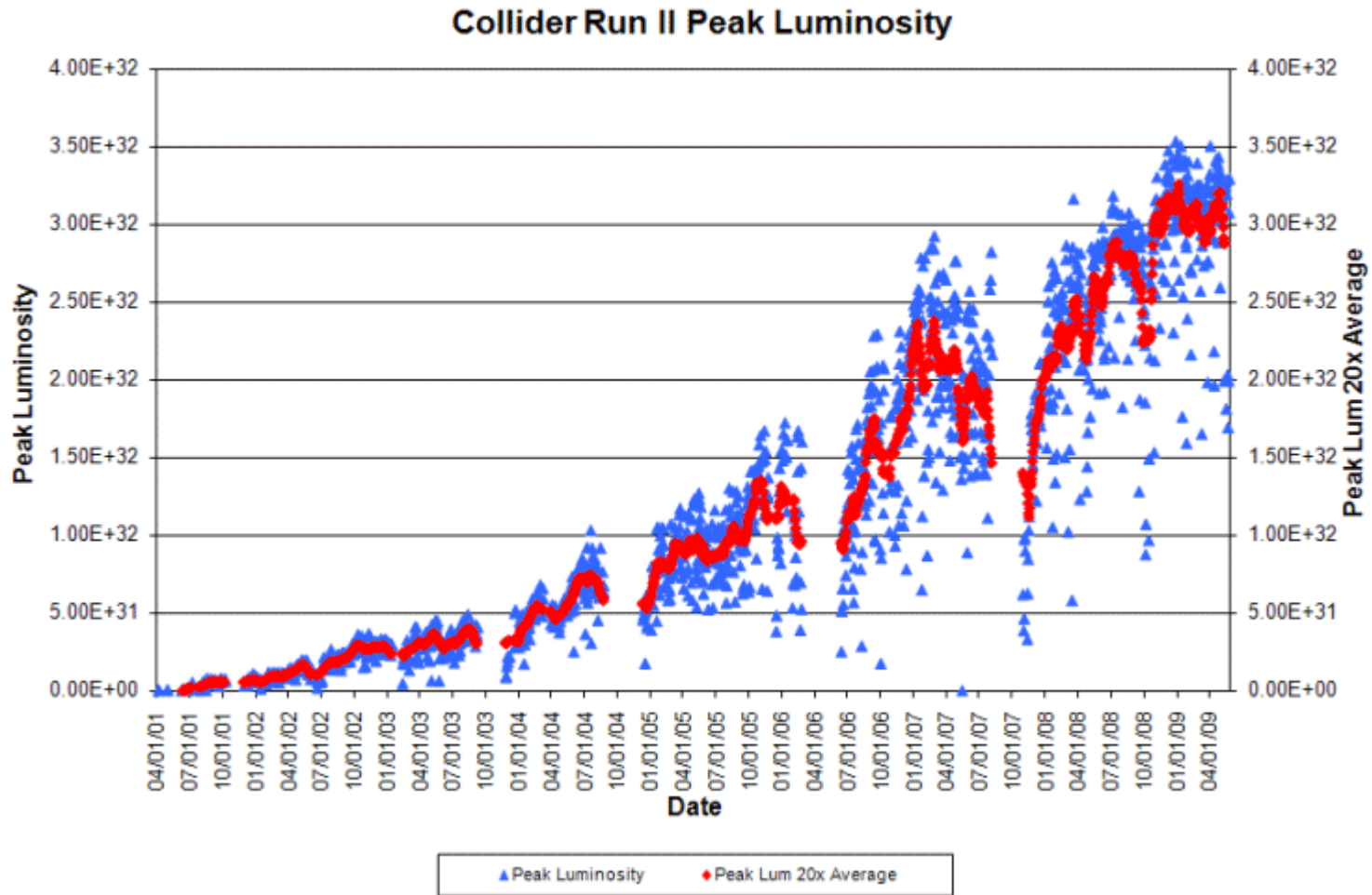



Peak Luminosity



$$L = \frac{N_b^2 n_b f_r \gamma}{4\pi \epsilon_n \beta^*} F$$

- N_b** number of particles per bunch
- n_b** number of bunches
- f_r** revolution frequency
- ϵ_n** normalised emittance
- β^*** beta value at Ip
- F** reduction factor due to crossing angle

- N_b, ϵ_n** → injector chain
- β^*** → LHC insertion
- F** → beam separation schemes
- n_b** → electron cloud effect



LHC Upgrade-Phase I



Goal of “Phase I” upgrade:

Enable focusing of the beams to $\beta^*=0.25$ m in IP1 and IP5, and reliable operation of the LHC at double the operating luminosity on the horizon of the physics run in 2013.

Scope of “Phase I” upgrade:

1. Upgrade of ATLAS and CMS experimental insertions. The interfaces between the LHC and the experiments remain unchanged at ± 19 m.
2. Replace the present triplets with wide aperture quadrupoles based on the LHC dipole cables (Nb-Ti) cooled at 1.9 K.
3. Upgrade the D1 separation dipole, TAS and collimation system so as to be compatible with the inner triplet aperture.
4. The cooling capacity of the cryogenic system and other main infrastructure elements remain unchanged.
5. Modifications of other insertion magnets (e.g. D2-Q4) and introduction of other equipment in the insertions to the extent of available resources.



Participants and Milestones



Several departments are involved in the “Phase I” project:

TE Department: low-beta quadrupoles and correctors, D1 separation dipoles, magnet testing, magnet protection and cold powering, vacuum equipment, QRL modifications.

BE Department: optics and performance, power converters, instrumentation, TAS and other beam-line absorbers, ...

EN Department: cryostat support and alignment equipment, interfaces with the experiments, installation, design effort, ...

SLHC-PP collaborators.

Milestones:

Conceptual Design Report	mid 2008
Technical Design Report	mid 2009
Model quadrupole	end 2009
Pre-series quadrupole	2010
String test	2012
Installation	shutdown 2013



CERN accelerator complex

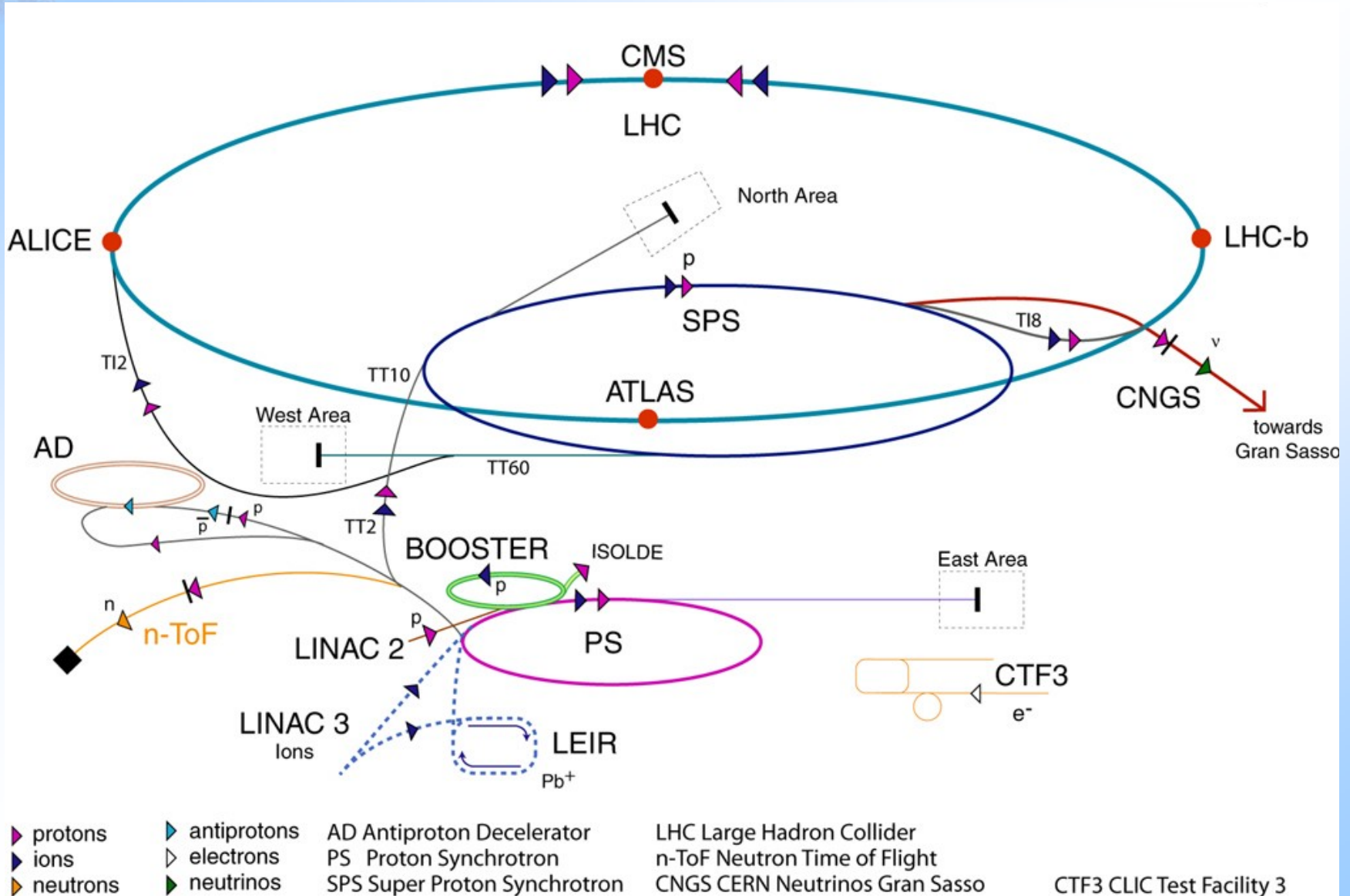



Present limitations



1. Lack of reliability:

Ageing accelerators (PS is 48 years old !) operating far beyond initial parameters

➔ need for new accelerators designed for the needs of SLHC

2. Main performance limitation:

Excessive incoherent space charge tune spreads DQSC at injection in the PSB (50 MeV) and PS (1.4 GeV) because of the high required beam brightness N/e^* .

$$\Delta Q_{sc} \propto \frac{N_b}{\epsilon_{x,y}} \cdot \frac{R}{\beta\gamma^2}$$

with N_b : number of protons/bunch

$\epsilon_{x,y}$: normalized transverse emittances

R : mean radius of the accelerator

$\beta\gamma$: classical relativistic parameters

➔ need to increase the injection energy in the synchrotrons

- Increase injection energy in the PSB from 50 to 160 MeV kinetic
- Increase injection energy in the SPS from 25 to 50 GeV kinetic
- Design the PS successor (PS2) with an acceptable space charge effect for the maximum beam envisaged for SLHC: => injection energy of 4 GeV



Upgrade components

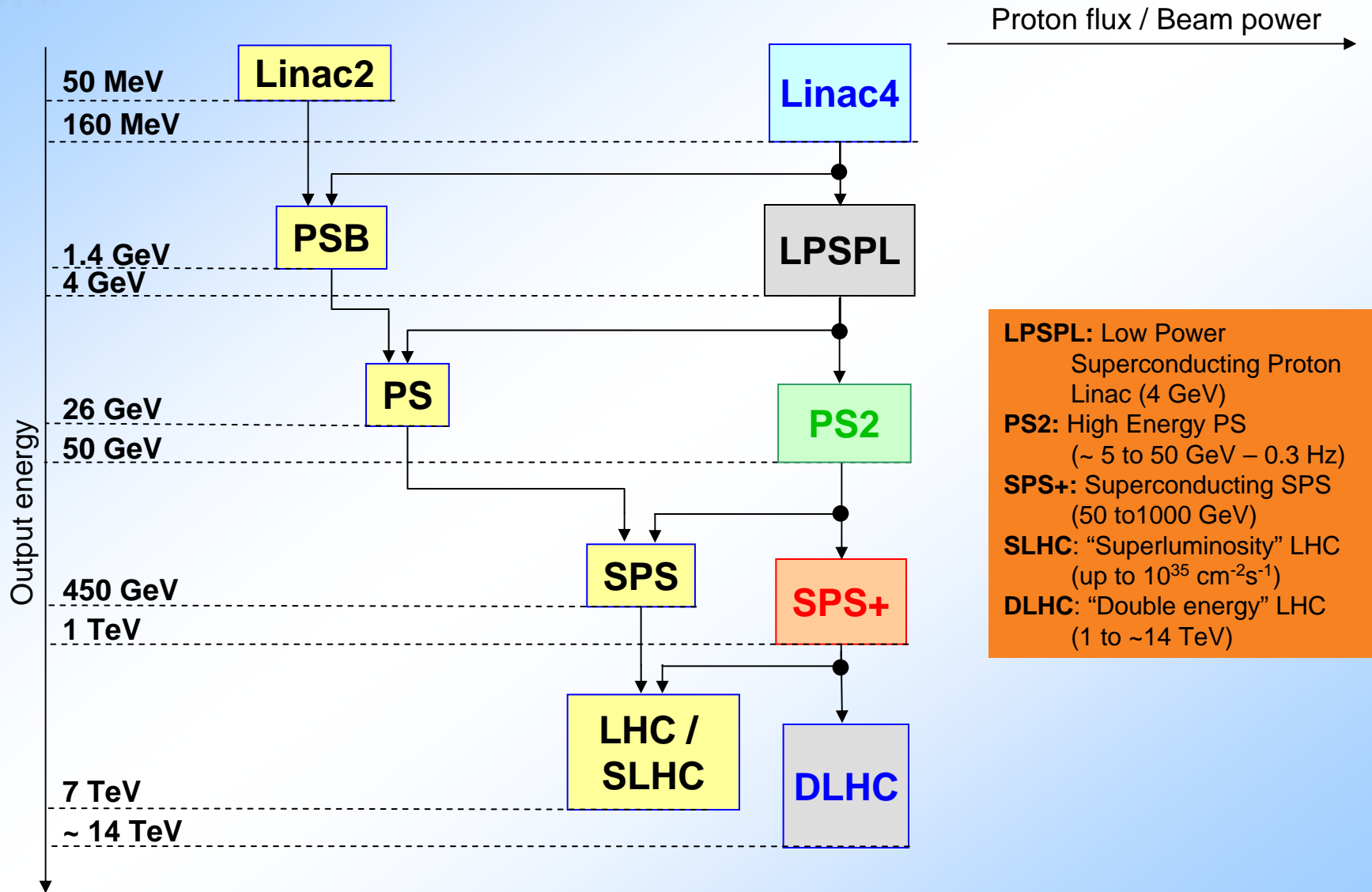



Layout of the new injectors

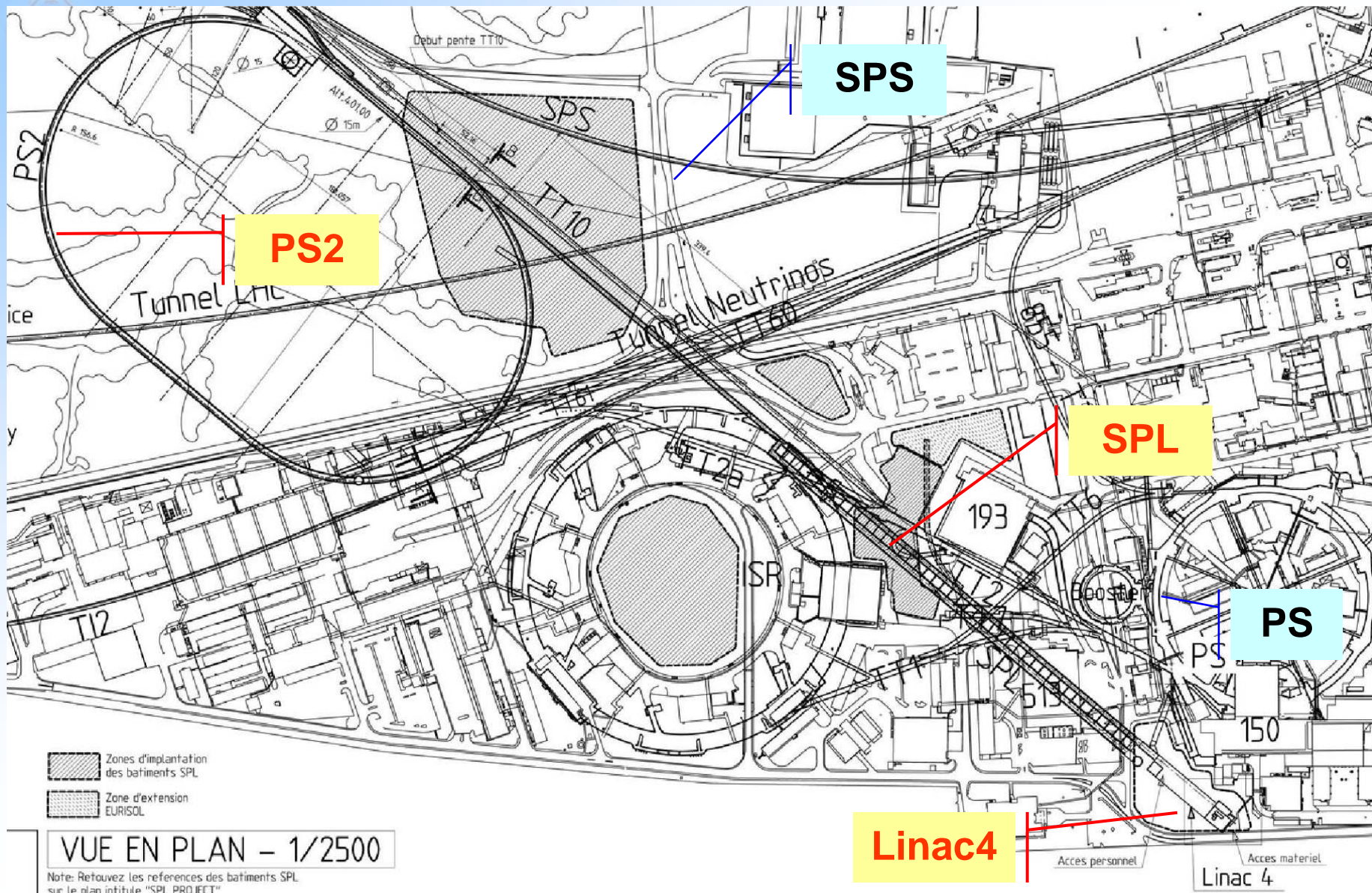

VUE EN PLAN - 1/2500

Note: Retrouvez les references des batiments SPL sur le plan intitule "SPL PROJECT"



Stage 1: Linac4



- **Direct benefits of the new linac**

Stop of Linac2:

- End of recurrent problems with Linac2 (vacuum leaks, etc.)
- End of use of obsolete RF triodes (hard to get + expensive)

Higher performance:

- Space charge decreased by a factor of 2 in the PSB
 - => potential to double the beam brightness and fill the PS with the LHC beam in a single pulse,
 - => easier handling of high intensity. Potential to double the intensity per pulse.
- Low loss injection process (Charge exchange instead of betatron stacking)
- High flexibility for painting in the transverse and longitudinal planes (high speed chopper at 3 MeV in Linac4)

First step towards the SPL:

- Linac4 will provide beam for commissioning LPSPL + PS2 without disturbing physics.

- **Benefits for users of the PSB**

Good match between space charge limits at injection in the PSB and PS

=> for LHC, no more long flat bottom at PS injection + shorter flat bottom at SPS injection: easier/ more reliable operation / potential for ultimate beam from the PS

More intensity per pulse available for PSB beam users (ISOLDE) – up to 2'

More PSB cycles available for other uses than LHC



Stage 2: LPSPL + PS2



- **Direct benefits of the LPSPL + PS2**

Stop of PSB and PS:

- End of recurrent problems (damaged magnets in the PS, etc.)
- End of maintenance of equipment with multiple layers of modifications
- End of operation of old accelerators at their maximum capability
- Safer operation at higher proton flux (adequate shielding and collimation)

Higher performance:

- Capability to deliver 2.2' the ultimate beam for LHC to the SPS
 - => potential to prepare the SPS for supplying the beam required for the SLHC,
- Higher injection energy in the SPS + higher intensity and brightness
 - => easier handling of high intensity. Potential to increase the intensity per pulse.

First step towards the SPL:

- Linac4 will provide beam for commissioning LPSPL + PS2 without disturbing physics.

- **Benefits for users of the LPSPL and PS2**

More than 50 % of the LPSPL pulses will be available (not needed by PS2)

=> New nuclear physics experiments – extension of ISOLDE (if no EURISOL)...

Upgraded characteristics of the PS2 beam wrt the PS (energy and flux)

Potential for a higher proton flux from the SPS



Stage 2': SPL



Upgrade the LPSPL into an SPL (multi- MW beam power at 2-5 GeV):

- 50 Hz rate with upgraded infrastructure (electricity, water, cryo-plants, ...)
- 40 mA beam current by doubling the number of klystrons in the superconducting part)

Possible users

- **EURISOL (2nd generation ISOL-type RIB facility)**

- => special deflection system(s) out of the SPL into a transfer line
- => new experimental facility with capability to receive 5 MW beam power
- => potential of supplying b-unstable isotopes to a b-beam facility...

- **Neutrino factory**

- => energy upgrade to 5 GeV (+70 m of sc accelerating structures)
- => 2 fixed energy rings for protons (accumulator & compressor)
- => accelerator complex with target, m capture-cooling-acceleration (20-50 GeV) and storage



Planning ...



3 MeV test place ready

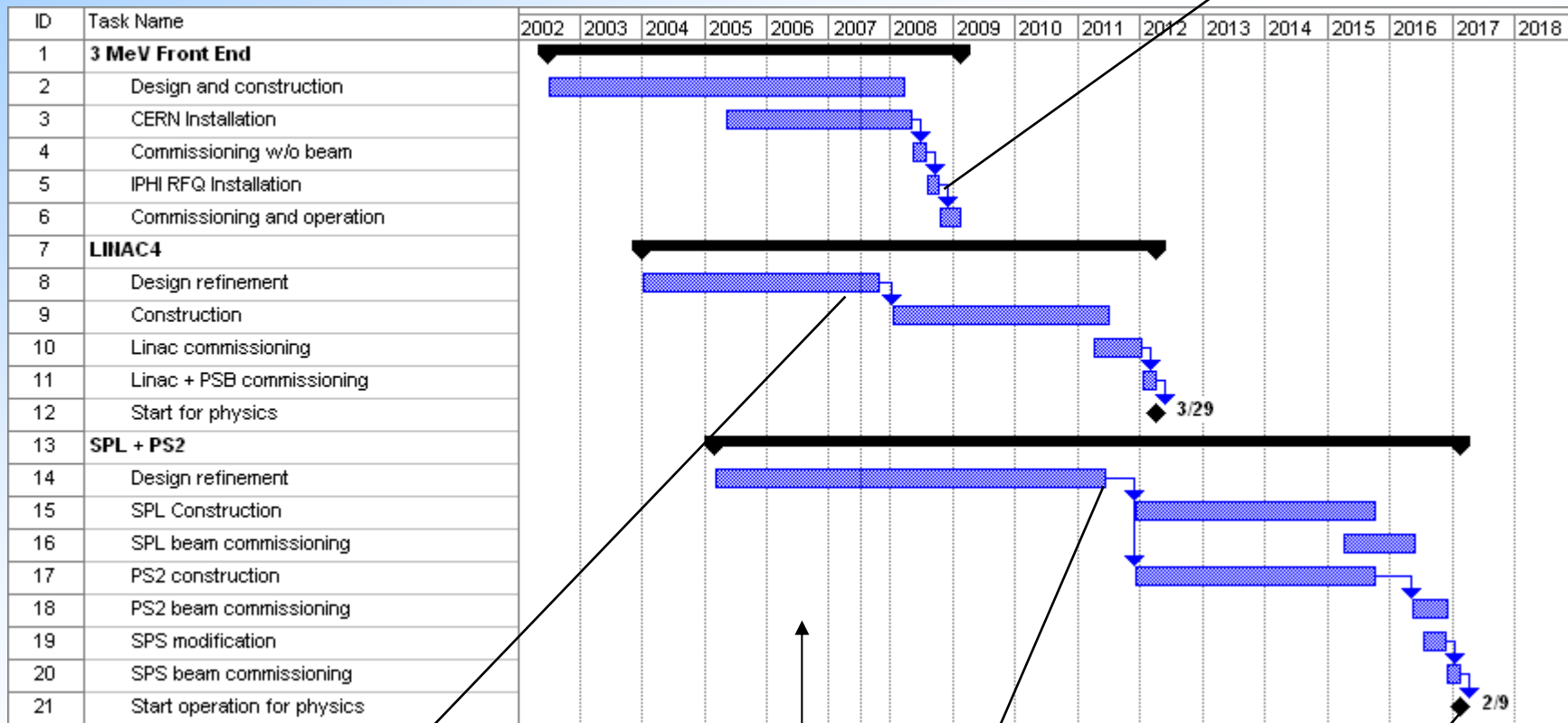

Linac4 approval

CDR 2

SPL & PS2 approval

Start for Physics



Peak luminosity...

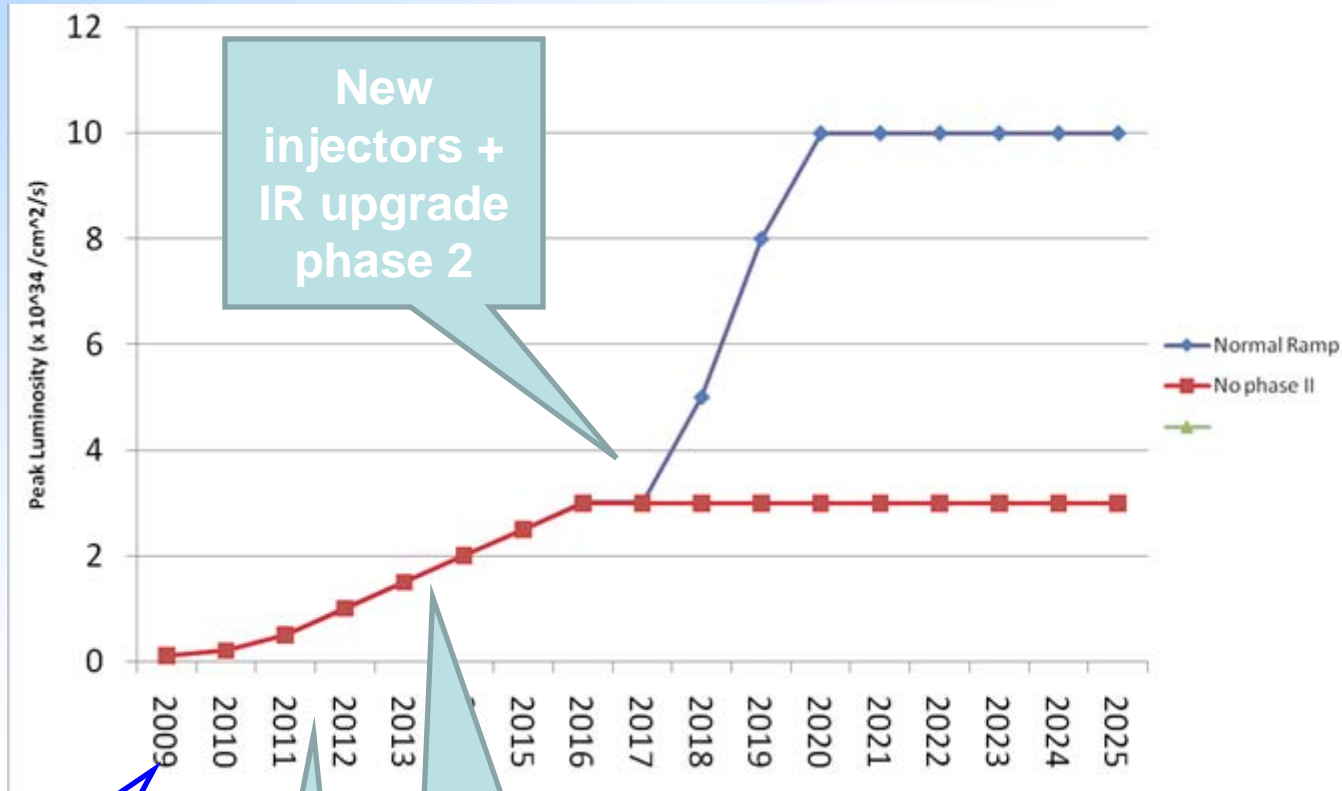

New injectors + IR upgrade phase 2

Linac4 + IR upgrade phase 1

Collimation phase 2





Integrated luminosity...

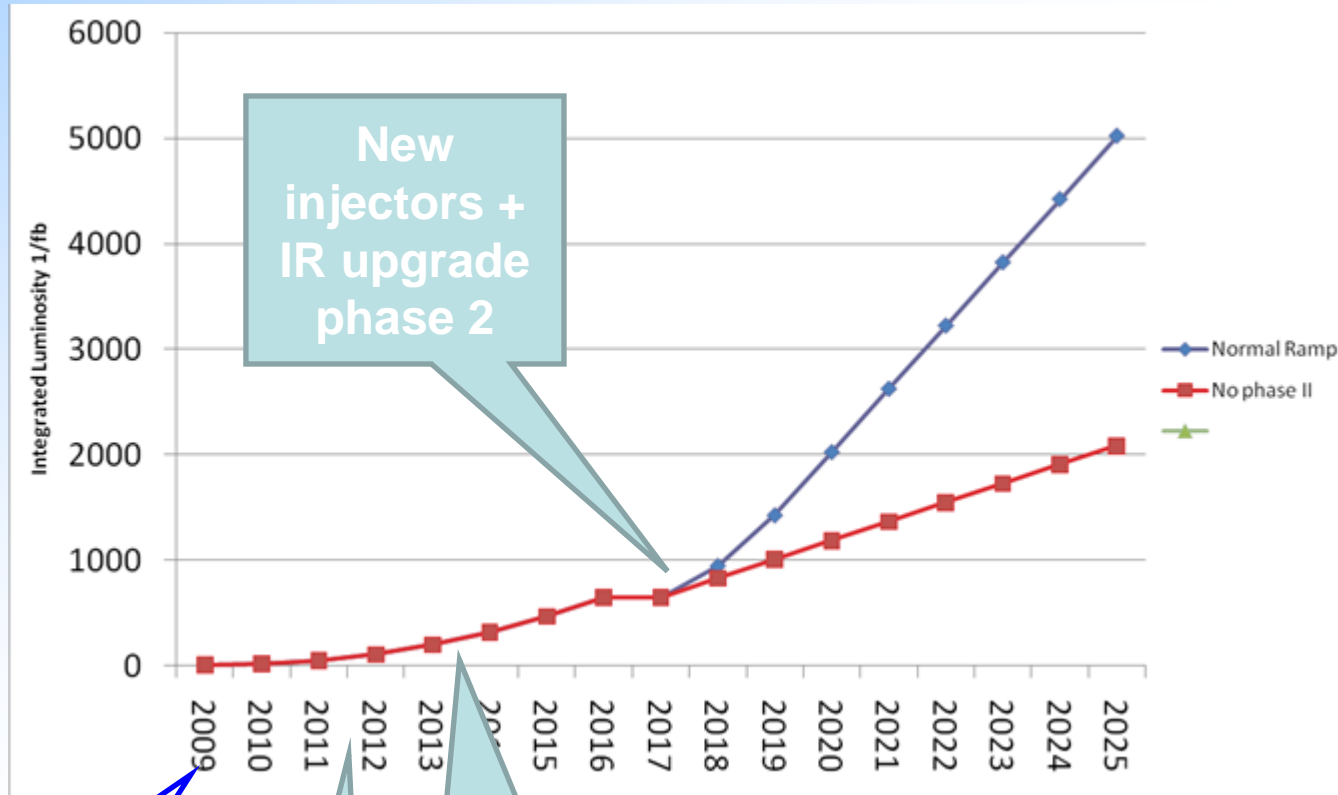

Collimation phase 2

Linac4 + IR upgrade phase 1

New injectors + IR upgrade phase 2