

Accelerating Structure Feasibility

W. Wuensch
CLIC ACE
26-5-2009

Outline

- Requirement summary
- Demonstration status
- Near-term prospects
- Contingency planning
- Longer-term development

Performance requirements oversimplified into a few numbers:

- Loaded gradient: 100 MV/m
- Pulse length total/flat top: 240/160 ns
- Breakdown rate in the range of a few $10^{-7}/\text{m}$
- Minimum average a/λ : 0.11 (short range wake)
- Maximum long range wake: 6 V/pC/m/mm

Status

Structure for SLAC Test



Structure for KEK Test

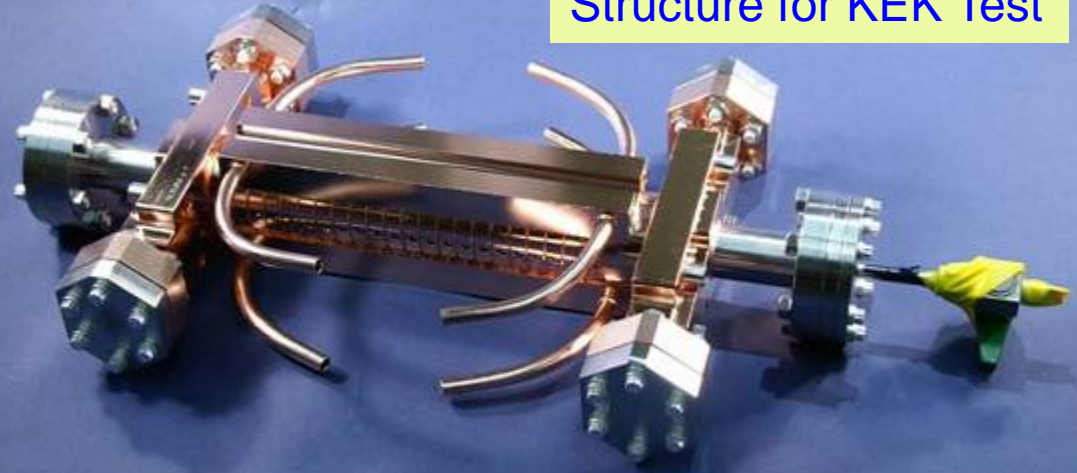

Unloaded Gradient at Different Conditioning Times

For Constant Breakdown Rate

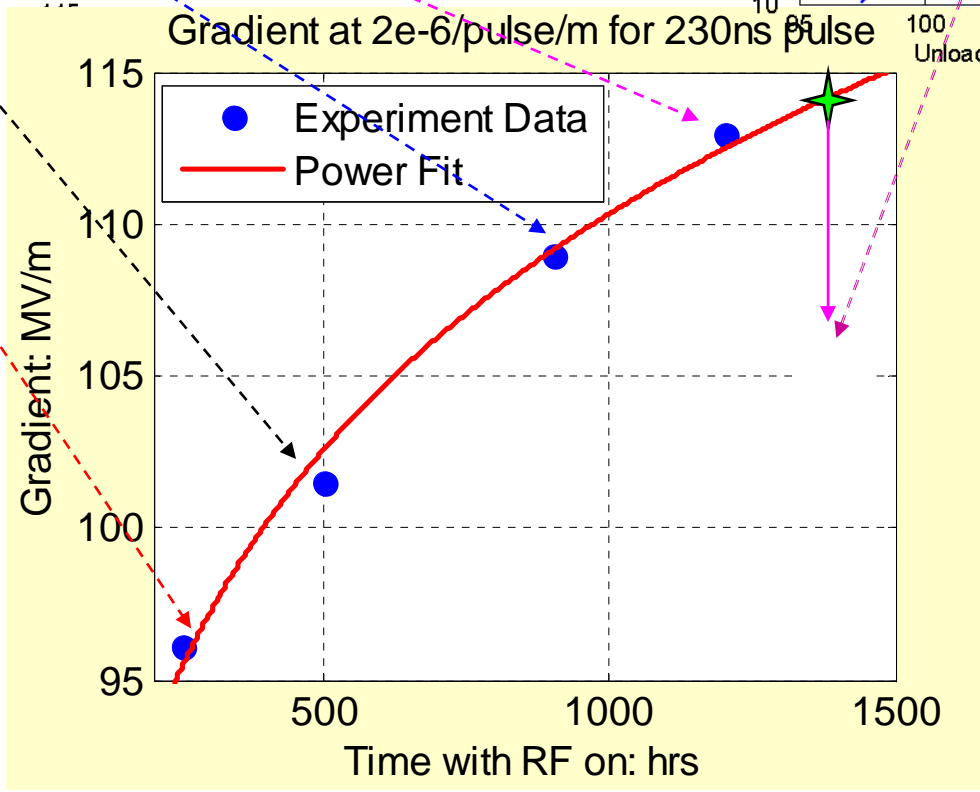
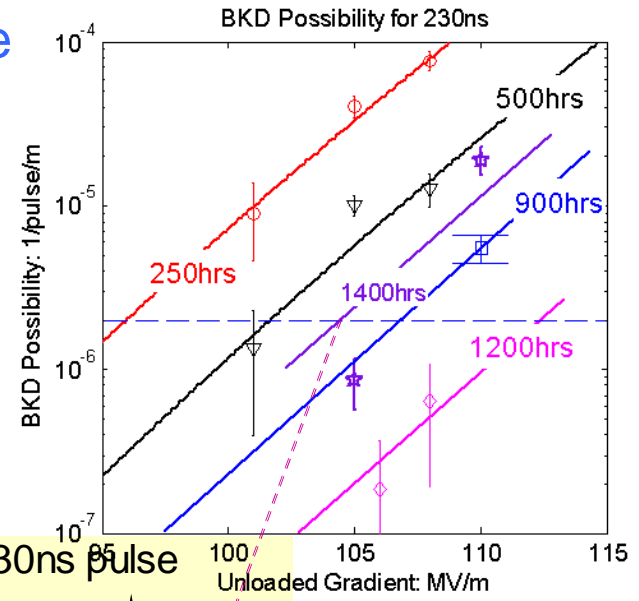
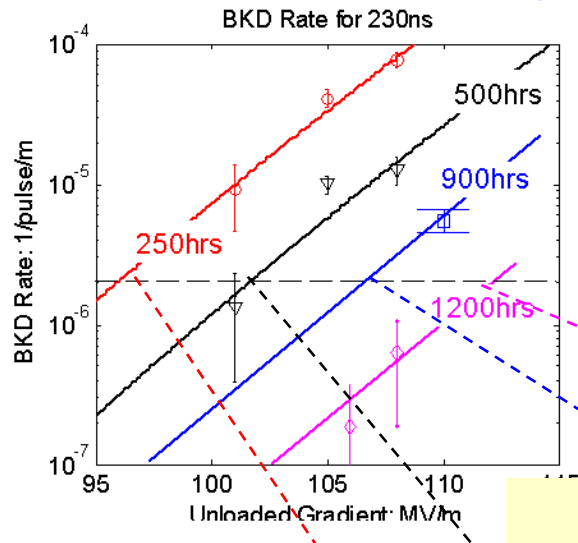

BKD Distribution Along Structure at Different Stages of Processing

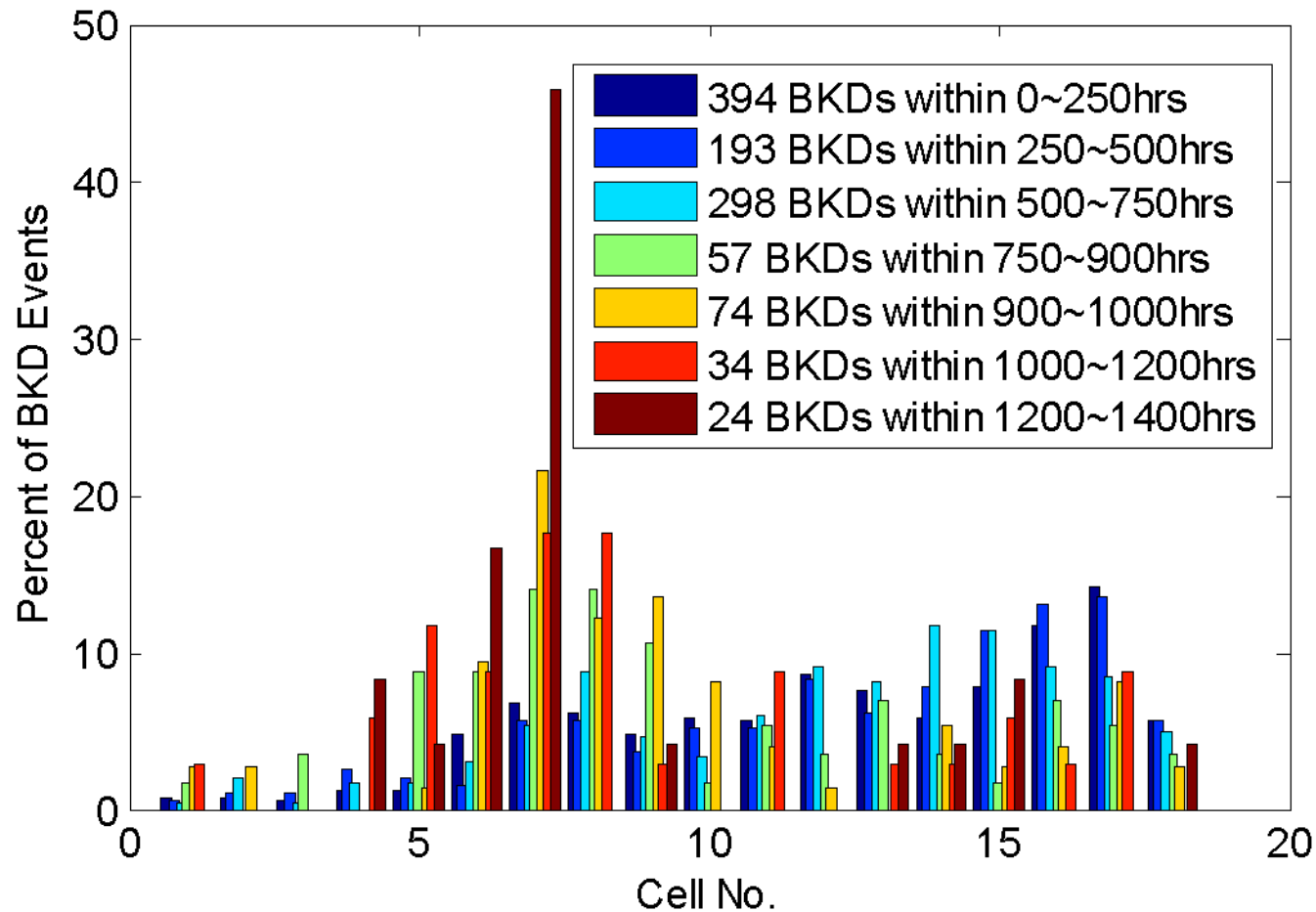

C. Adolphsen

Did not find visual evidence related to the hot cell in a post-run boroscope exam – typical of NLC/GLC structures, many of which had hot cells

BDR at 252nsec

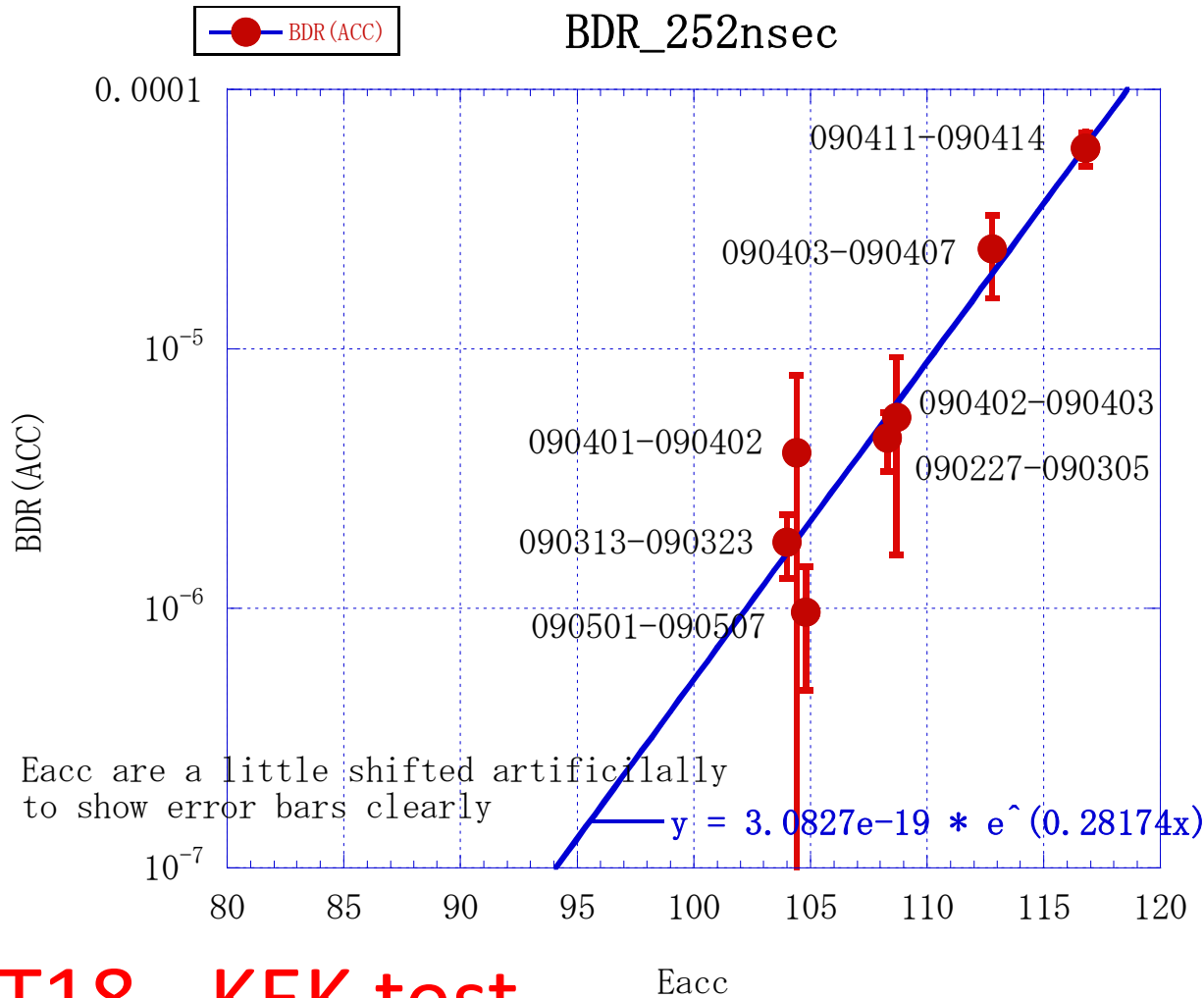

ACC breakdowns are defined as sudden breakdowns from normal running.

This excludes events following such breakdowns, typically only the very first pulse.

Even if include such associated breakdowns, the BDR stays within a factor two.

Comparable or larger number of FC-UP events are still to be investigated in their origin.

T18 - KEK test

Status summary

Two undamped T18 structures have run at an unloaded accelerating gradient at around 100 MV/m with the CLIC specified 4×10^{-7} /m breakdown rate with 230/250 ns rectangular pulses.

The CLIC flat-top is 160 ns, full width at 90% maximum gives effective pulse length, so we are above specification here.

Beam loading typically reduces the gradient by 15 to 20% (18% in CLIC_G), but this may be partially compensated by a corresponding decrease in breakdown rate, especially in strongly tapered structures. The magnitude of the beam loading effect is to be studied in two beam test stand.

The increased gradient was achieved through the use of high-power scaling laws in the design process.

Near-term prospects

Then next crucial step for the accelerating structure feasibility demonstration is to determine the influence of the damping features on gradient.

We believe that this effect will be small because,

- The (smaller) damping features of the NLC/JLC structures did not affect high-gradient performance. The H75 with manifold damping ran at 102 MV/m, 150 ns rectangular pulse, 6×10^{-6} BDR/structure for example.
- An artful analysis of the slotted-iris quadrant (HDS60 in particular) data indicates their (smaller) damping features did not affect performance. Requires geometric scaling of gradient, so not definitive demonstration.

HOWEVER the pulsed surface heating we have now, over 50 C, is significantly higher than other structures, around 20 C, and breakdown and pulsed surface heating could be linked in a number of ways.

We also move towards the nominal CLIC_G geometry which has what we now, through better understanding of iris scaling, believe is a more optimum iris range. This helps also with pulsed surface heating.

Transition from undamped to damped in the CLIC_vg1 type

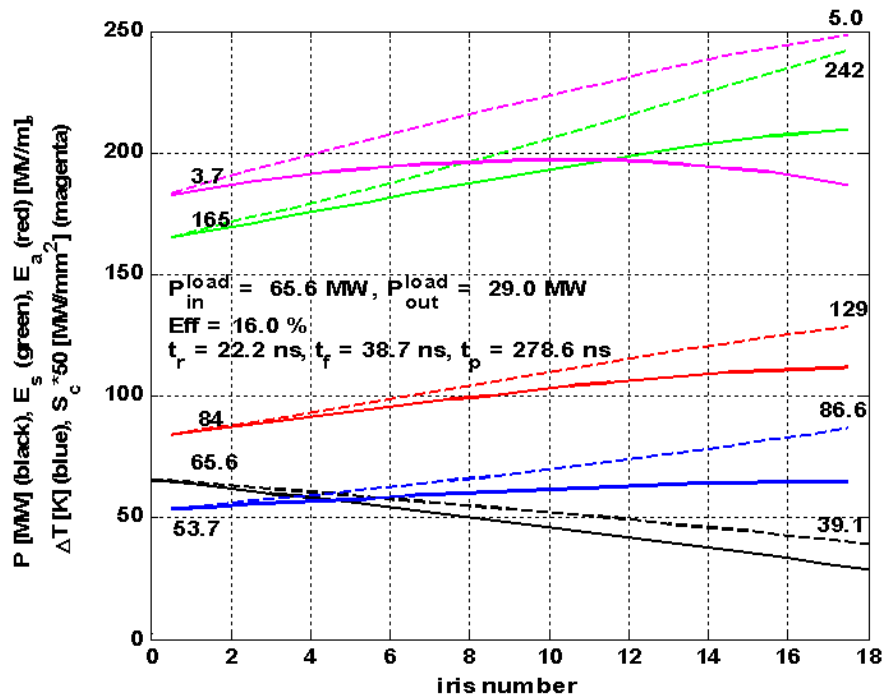
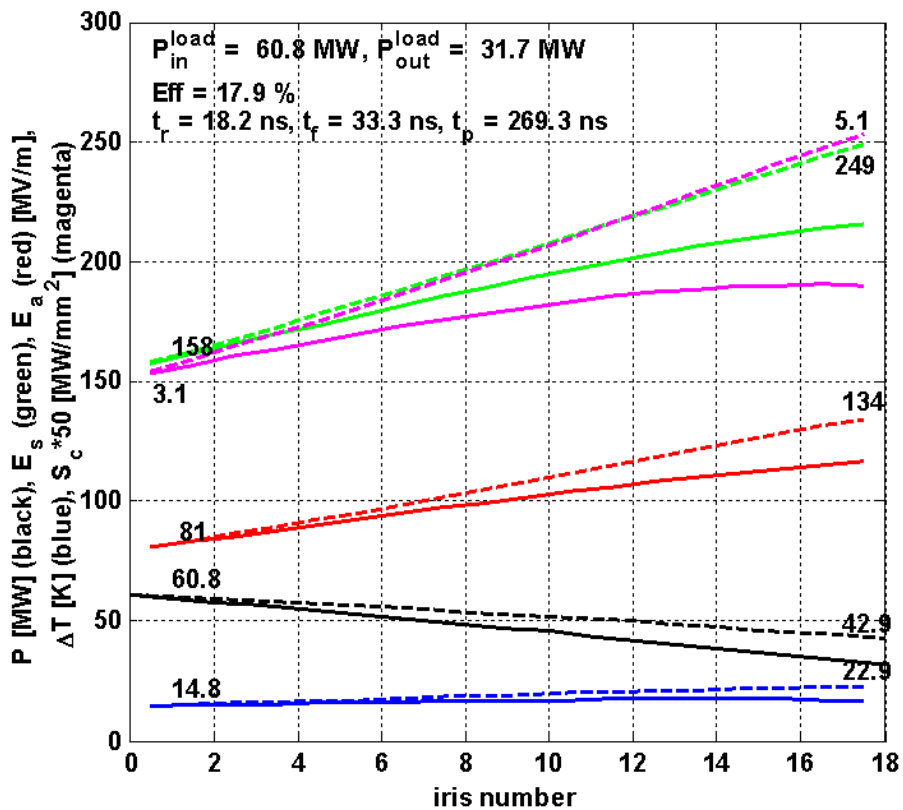

undamped

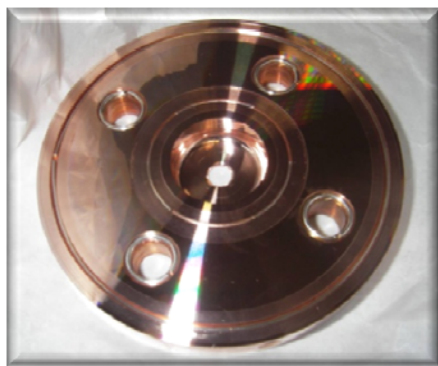

damped

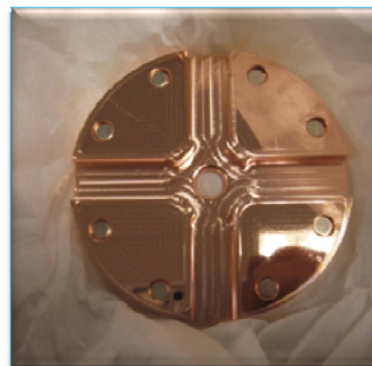

Structures under test

Test station	Structure	2009												2010			
		1	2	3	4	5	6	7	8	9	10	11	12	1	2	3	
Nextef	TD18_vg2.4_quad#5	KEK					KEK										
Nextef	T18_vg2.4_disk#2	KEK															
Nextef	T18_vg2.4_disk#4	SLAC											KEK				
Nextef	TD18_vg2.4_disk#2	KEK			SLAC		SLAC		KEK								
NLCTA1	T24_vg1.8_disk(11.4)#1	CERN		CERN			SLAC1										
NLCTA1	TD24_vg1.8_disk(11.4)#1	CERN				CERN		SLAC1									
NLCTA2	T18_vg2.4_disk#3	SLAC				SLAC2											
NLCTA2	TD18_vg2.4_disk#3	KEK			SLAC		SLAC		SLAC2								
NLCTA2	T28_vg2.6 (T26)																

Legend	
P	prototype
	RF design
	mechanical design
	fabrication
	bonding/assembly
	heat treatment
	testing

Structures under test

Test station	Structure	2009												2010			
		1	2	3	4	5	6	7	8	9	10	11	12	1	2	3	
ASTA	C10_vg0.7#1		SLAC	SLAC				SLAC3									
ASTA	C10_vg1.35#1		SLAC	SLAC					SLAC3								
ASTA	CD10_vg1.35#3					P		CERN			CERN			SLAC3			
ASTA	PETS 11.4 no damping						SLAC3										
ASTA	PETS 11.4 damping			CERN			CERN				SLAC3						
TBTS	T24_vg1.8_disk (12)		CERN			CERN			CERN								
TBTS	TD24_vg1.8_disk#1 (12)		CERN			CERN											
TBTS	PETS 12 no damping	C			CERN												
TBTS	PETS 12 damping									CERN			CERN				

Legend	
P	prototype
	RF design
	mechanical design
	fabrication
	bonding/assembly
	heat treatment
	testing

Structures are directly relevant for determining the effect of damping

Structure	Built by	Status	Scheduled test date	Test location
TD18 #1	CERN	Ready	March, but on hold	SLAC
TD18 #2	KEK/SLAC	Under assembly	September	KEK
TD18 #3	KEK/SLAC	Under assembly	August	SLAC
TD24 #1 and 2	CERN	Under assembly	August	SLAC
TD18 QUAD #2	KEK	Final assembly	June	KEK

If any one of these structures show a satisfactory gradient we will have demonstrated feasibility.

Fabrication issues

Currently the majority of the test structures are made by KEK and SLAC due to their extensive experience in building low-breakdown rate structures. These structures are made by 1020 °C hydrogen brazing.

In recent months we have made our first brazed disk X-band structure since the early nineties. Our technique, 820 °C bond/braze, is basically the same as Fermilab's.

Unfortunately this T18 ran very badly. We have cut it apart, compared it to measurements and analyzed it,

All iris - presence of small craters.
S particles along grain boundaries – from bulk

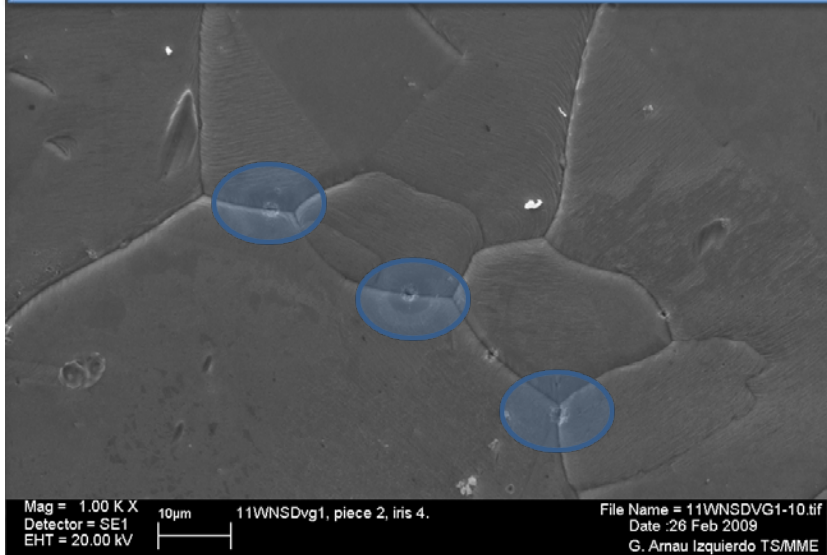

Iris 12 – contamination (Ca, C)

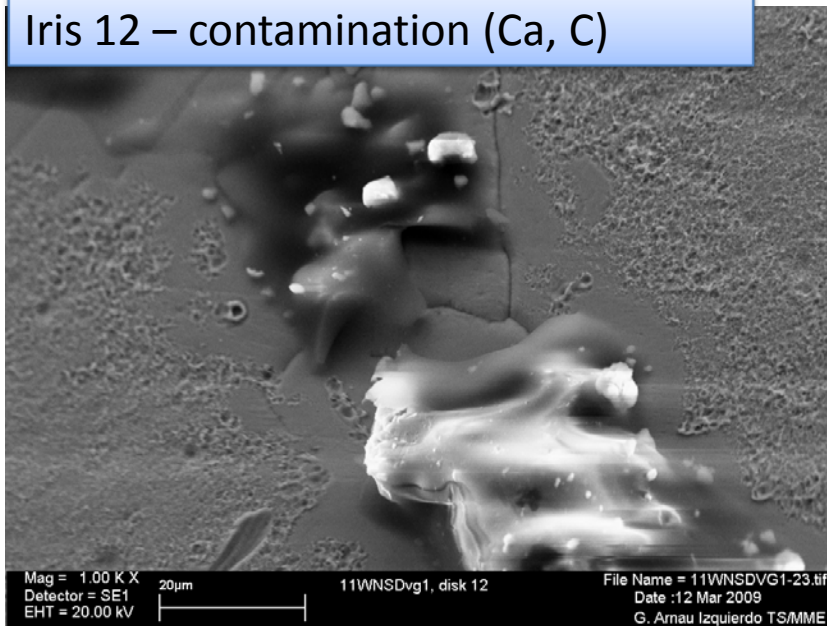

T18_CERN

Breakdown distribution of
T18Disk_SLAC (red, last 500hrs),
210~230 ns, 110~120 MV/m
T18Disk_CERN (Blue, 40hrs).
180 ns, 45~49 MV/m

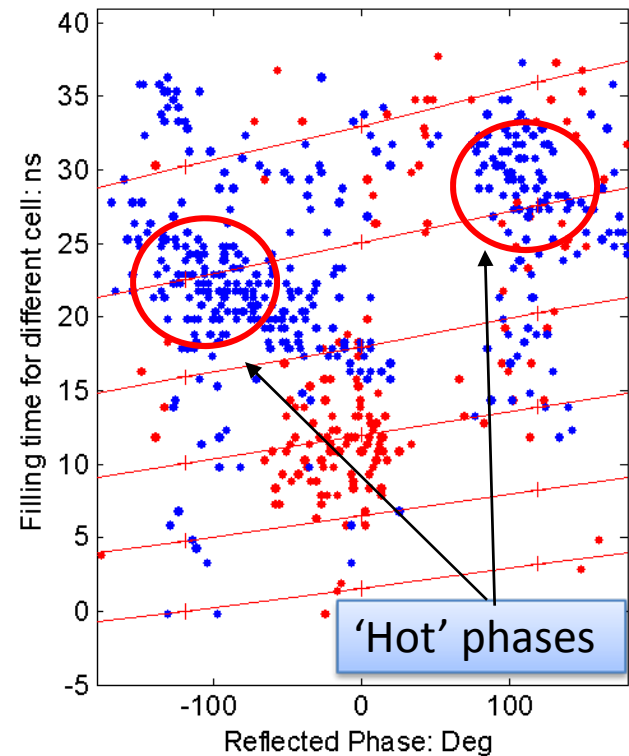

Reacting to the CERN T18 result

The poor performance was probably determined by a contamination on iris 12. However the discovery of presence of S particles from the bulk Cu is indicative of a more systematic problem – which calls into question our 30 GHz results...

Our response is to now assemble under a laminar flow hood to reduce the chances of contamination like that seen on iris 12. In addition we have also adopted the main difference with the Fermilab procedure, a 1000 °C disk pre-fire. One benefit is this seems to ensure that S stays dissolved in the bulk and doesn't collect on grain boundaries.

Our T18 was preceded at SLAC by a number of 'exotic' structures which also ran badly. These structures incorporated many new ideas – materials and quadrants - from the 30 GHz, 150 MV/m program. I believe these structures were not limited by fundamental issues and that we will return to the ideas one day and get them to work.

But the consequence is that CERN has a credibility problem for delivering good structures.

An excellent new team with a rigorous approach is learning to build structures and I believe we will resolve our problems soon (maybe already). We hope our collaborators are patient with us.

Making duplicate structures according to KEK/SLAC techniques (mainly high-temp bonding in H₂ atmosphere) should help clear things up. **And we must have a testing program here at CERN to get the timely feedback that we need.**

Contingency planning
(also stuff which might be
better in the long run)

Contingency planning – What can we do if the effect of the heavy damping features on gradient is significant?

A lot of course depends on *why* the gradient is reduced. But to cover this possibility we are actively considering different damping mechanisms.

In addition, the “classic” problem of surface damage through pulsed surface heating fatigue has not gone away. We have a ΔT of 56 °C in the nominal CLIC structure, which is very high for our baseline design of brazed copper disks.

We could end up with a 4000 hour test that goes fine, but the structures all fall apart after a couple of years.

We believe we have two types of solutions – damping configuration and material.

Manifold damping – Roger Jones (now at Cockcroft Inst/ and Manchester U.) and Vasim Kahn are applying the DDS concept to 100 MV/m using our scaling laws. The high gradient performance of the damping has already demonstrated. However the much weaker damping means the bunch spacing must go up and efficiency down. That is unless we have the tolerances for dipole mode zero crossings... A CLIC DDS design and prototype is an FP7 activity.

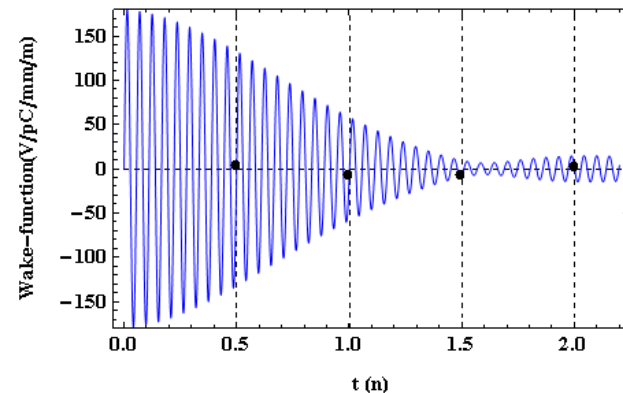
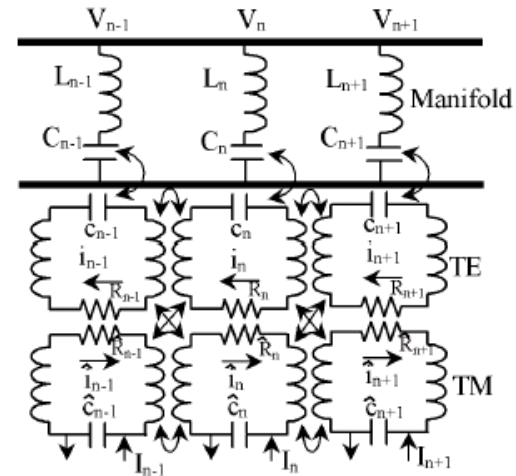
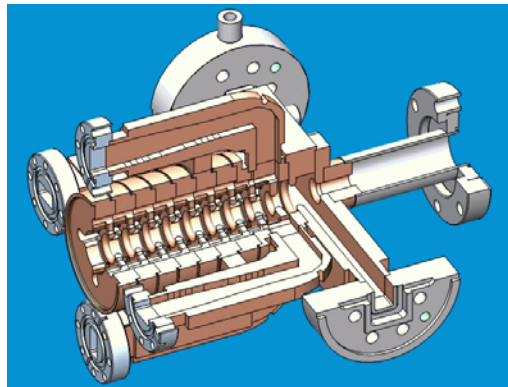
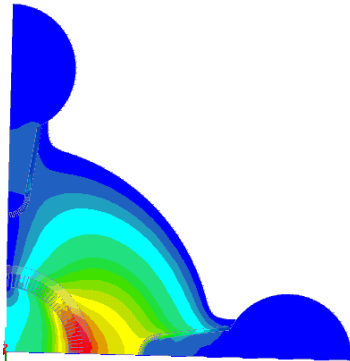

Wake-field Suppression in CLIC_DDS Main Linac -Initial design

design

- Circuit model provides rapid determination of optimal wakefield suppression results in a bandwidth of 3.6σ (3.36 GHz) and $\Delta f / f_c = 20\%$.
- Leftmost indicates the modal distribution and rightmost the coupled and uncoupled wakefield
- Four-fold interleaving of successive structures results in excellent wake-field suppression at the location of each bunch
- Meets CLIC beam dynamics requirements!
- However, breakdown

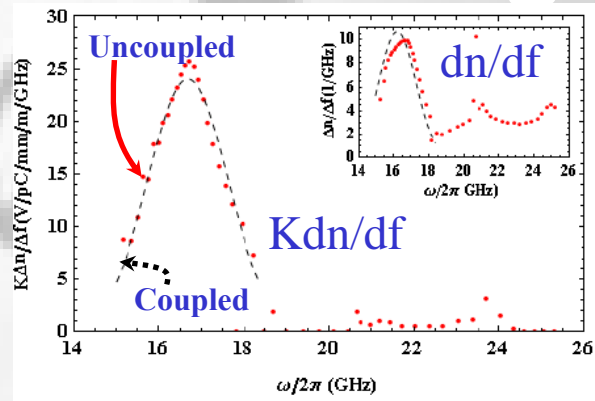

Kick Factor Weighted Density Function

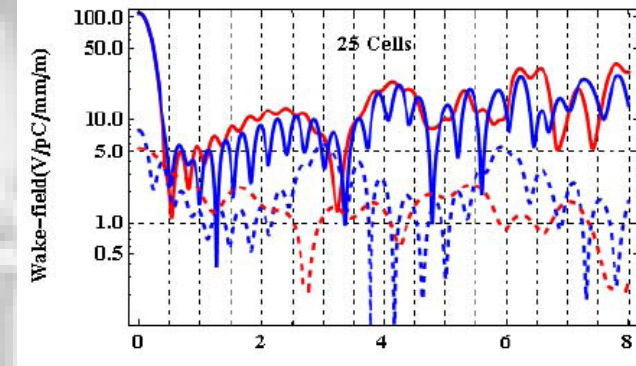

Envelope of Wakefield for Single 25-Cell Structure ($Q \sim \infty$)

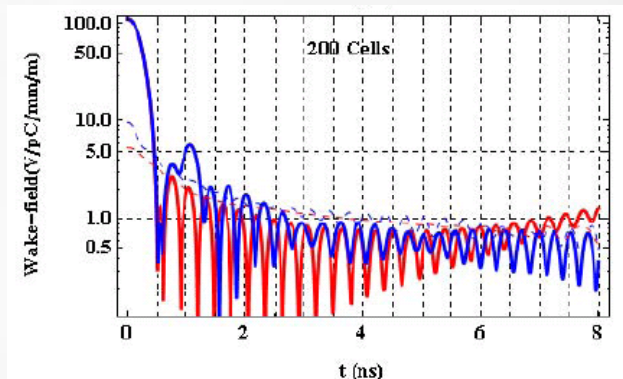

Wakefield for 8-Fold Interleaved Structure ($Q \sim \infty$)

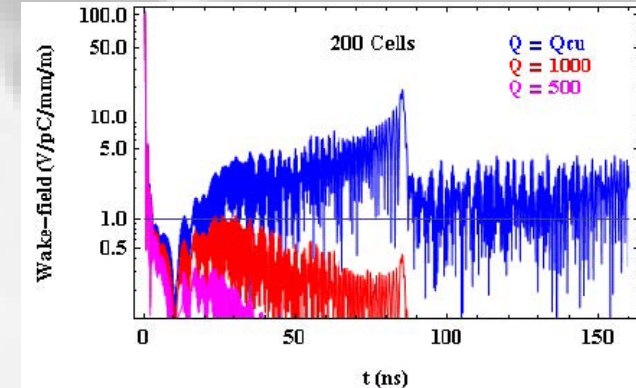

Envelope of Wakefield for 4-Fold Interleaved Structure (Finite Q)

Choke mode damping

Valery's first try at a **choke mode cavity** didn't work very well at high power. However Alexej has proposed a new configuration which will be high-power tested with a CD10-choke structure. Igor's choke flange is working beautifully.

We will study a choke mode CLIC structure in a collaboration with Tsinghua University and they will build a prototype. Fellow hopefully approved by end of week.

Pulse surface heating is way down compared to waveguide damping but so is the damping strength. Plus this assembly can be done without brazing, so high-strength copper alloys for example can be used.

Probably implies a larger bunch spacing. Damping loads are going to be tough...

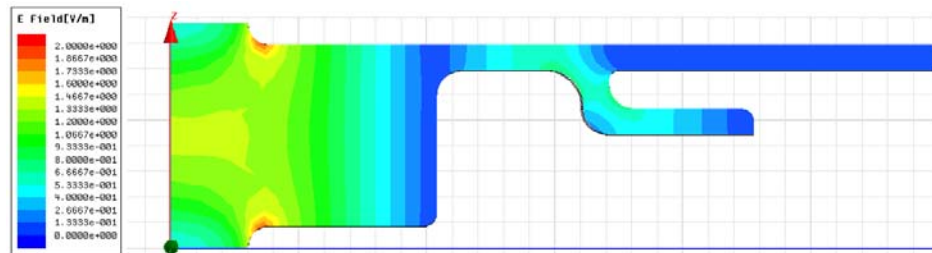

Slotted-iris structures made from quadrants

Excellent damping characteristics, especially with iris slots. Full range of materials and preparation techniques possible.

We had hints of success but mostly problems. The HDS60 had a performance consistent with brazed disks if you use scaling laws. The HDX-11 worked well for about 20 hours and an HDS4 worked well for about 7 hours. Is the subsequent deterioration fundamental or due to specific rf design features? Other quadrants didn't work well but were these problems fundamental or technical?

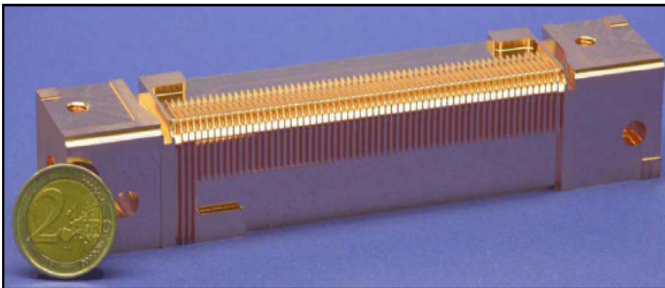
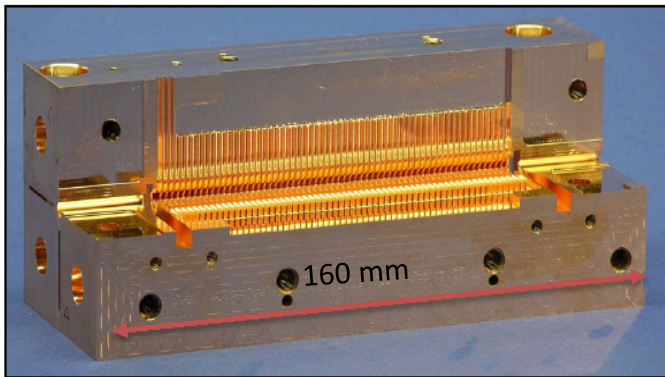

30 GHz HDS60

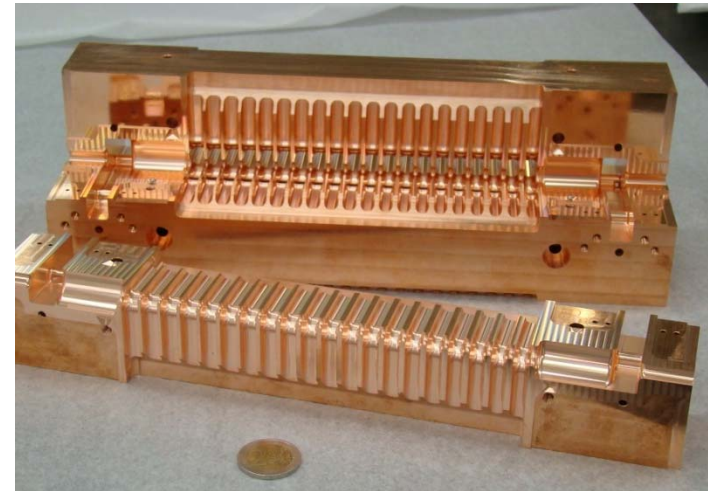

X-band HDX11

Longer-term prospects

Quantitative approach to high-gradients and efficient linacs

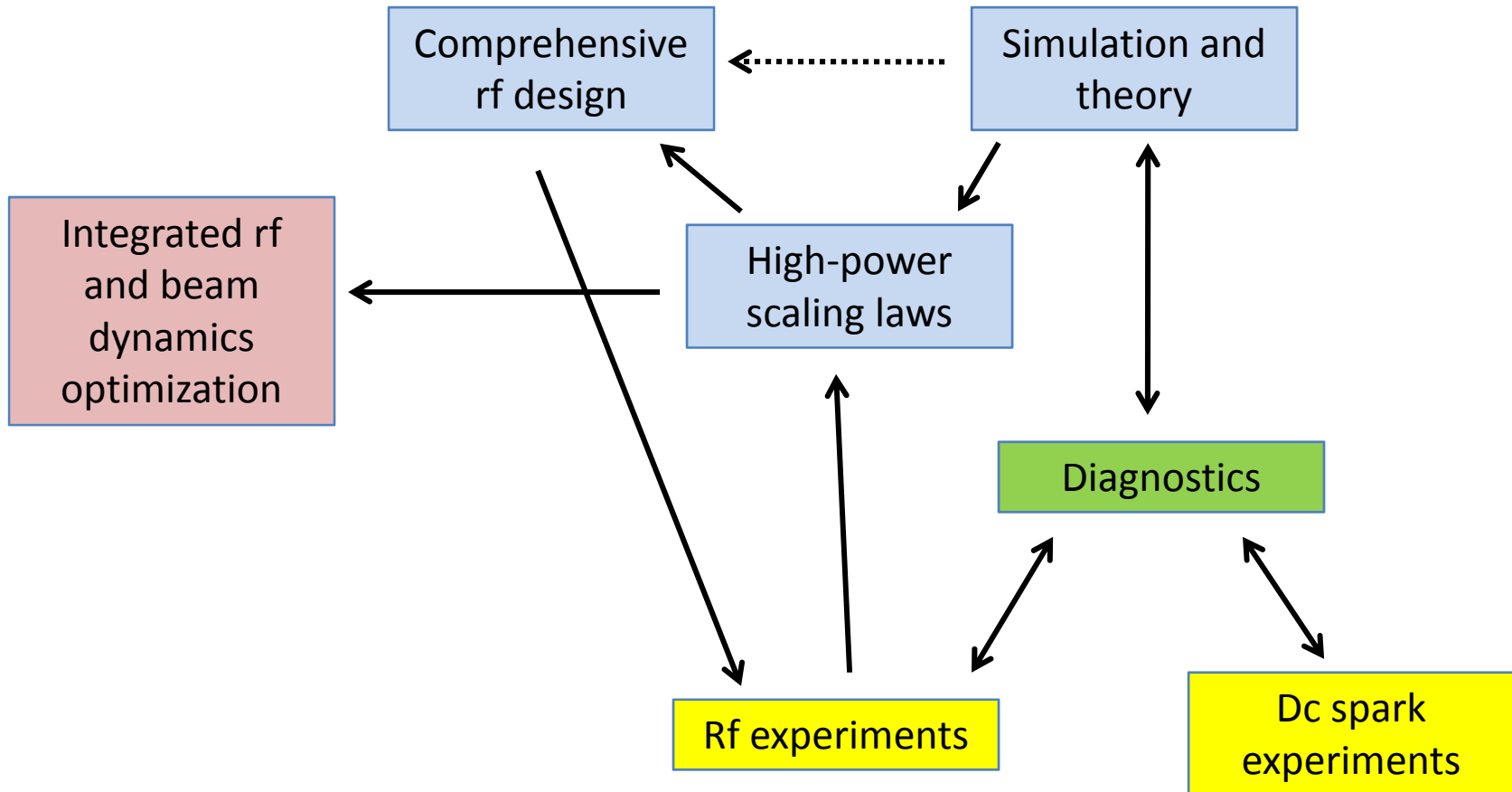

The importance of iris aperture

It is quite clear that iris aperture is the single most important structure parameter for both beam dynamics and gradient and consequently for overall efficiency.

The computation of short range wakes is well established. Original theory is by Karl Bane and others. We have even had a EuroTeV fellow (Riccardo Zennaro) to cross check theory with computation by GDFDL in our parameter range.

Analysis of existing high gradient data combined with some physical reasoning by Alexej and myself has resulted in gradient scaling parameters, P/C and S_c , which reflect and give, respectively, a very strong dependence of gradient on iris diameter.

To determine this crucial dependency more precisely, and to give input for further gradient scaling studies, a series of 10 cell structure tests, called C10's, with different iris sizes has been launched. Fabrication is at KEK and SLAC.

Schematic View for C10 Structures - II

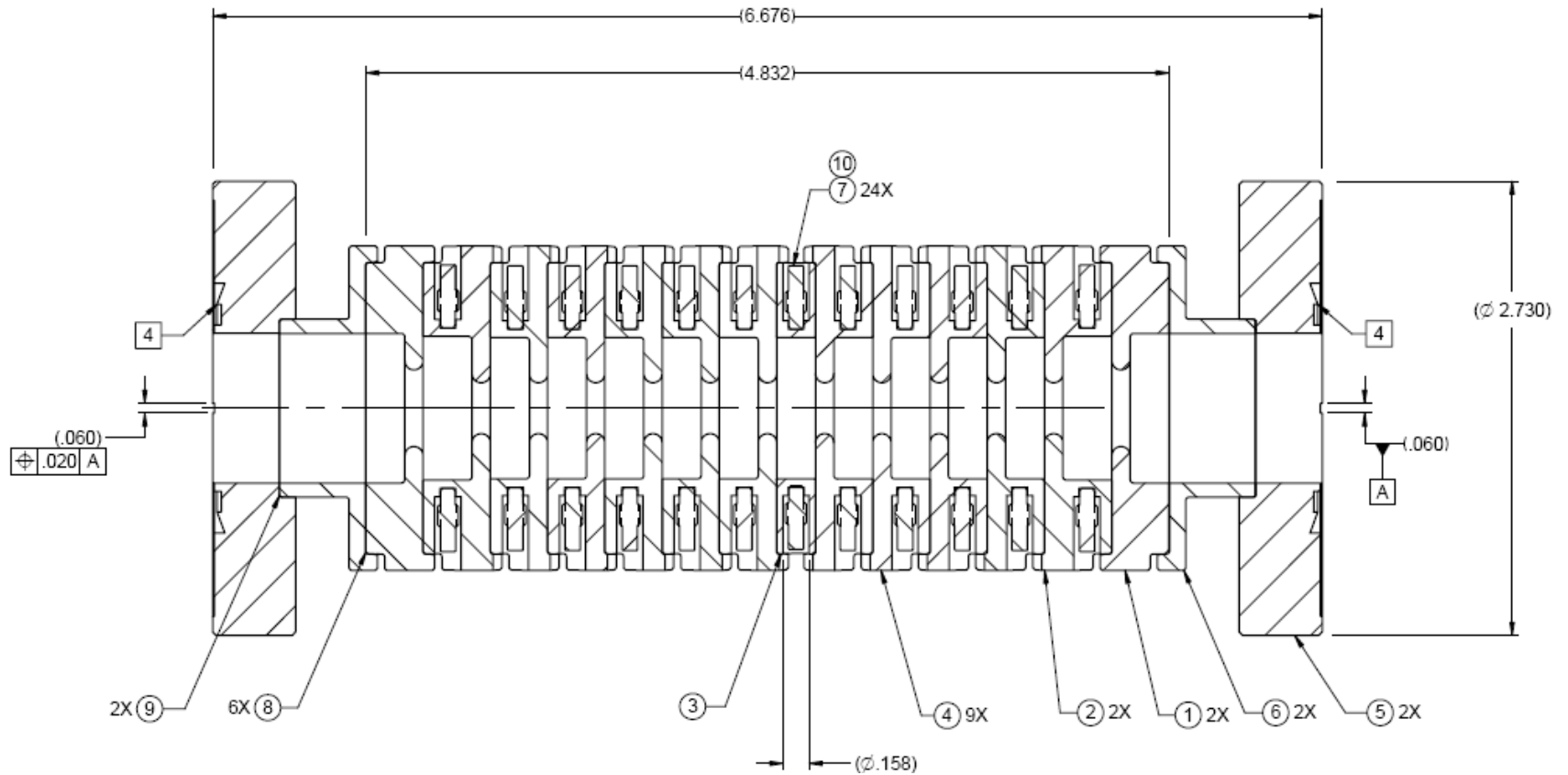

Subassembly for Test Cells

C10 structures

Test station or F [GHz]	Family	2009												2010		
		1	2	3	4	5	6	7	8	9	10	11	12	1	2	3
ASTA	C10_vg0.7#1			SLAC	SLAC			SLAC3								
ASTA	C10_vg1.35#1			SLAC	SLAC			SLAC3								
11.424	C10_vg0.7#2_SLAC	SLAC	SLAC	SLAC												
11.424	C10_vg1.35#2_SLAC	SLAC	SLAC	SLAC												
11.424	C10_vg2.25#1_SLAC					SLAC	SLAC	SLAC								
11.424	C10_vg2.25#2_SLAC					SLAC	SLAC	SLAC								
11.424	C10_vg3.3#1_SLAC						SLAC	SLAC	SLAC							
11.424	C10_vg3.3#2_SLAC						SLAC	SLAC	SLAC							
11.424	C10_vg1.35#3_KEK							KEK	SLAC	SLAC						
11.424	C10_vg1.35#4_KEK							KEK	SLAC	SLAC						
11.424/12	C10_vg1.35_CERN															
11.424/12	C10_vg1.35_milled															

Legend	
P	prototype
	RF design
	mechanical design
	fabrication
	bonding/assembly
	heat treatment
	testing

Other important effects

The next step will be to quantify the effect of tapering, which luckily seems to have a beneficial effect. Comparison of the T18, very strongly tapered, and the T24 will address this issue.

We believe this is due to transient power flow into a breakdown. And have made a 30 GHz test to address this issue, the “speed-bump”

Gradient might also be dependant on group velocity. To investigate this we have made the 30 GHz TM_{020} structure.

Speed bump (TM₀₃)

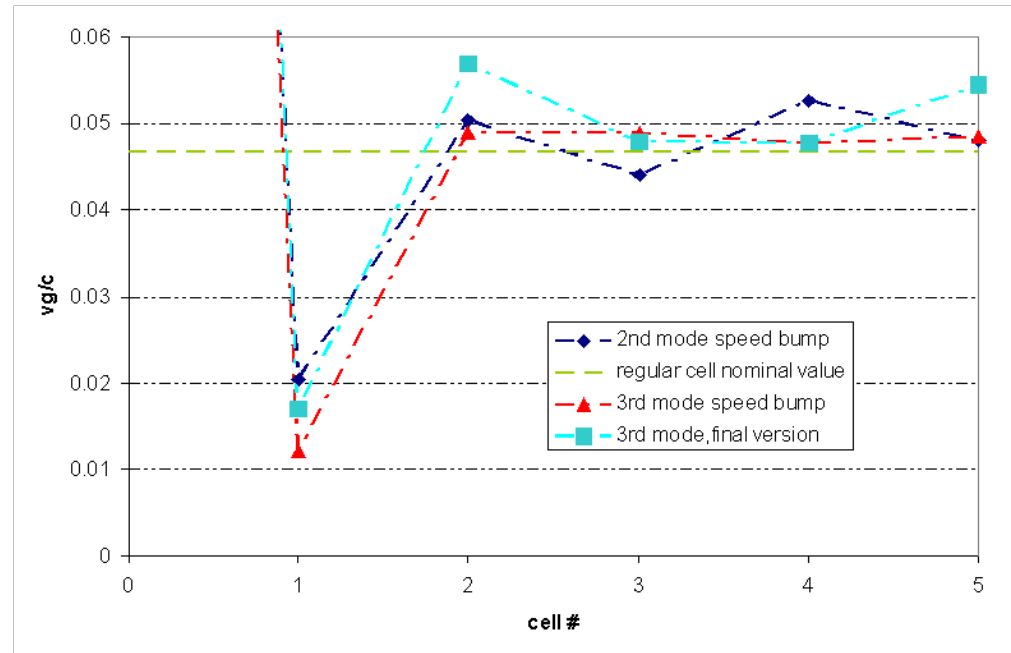
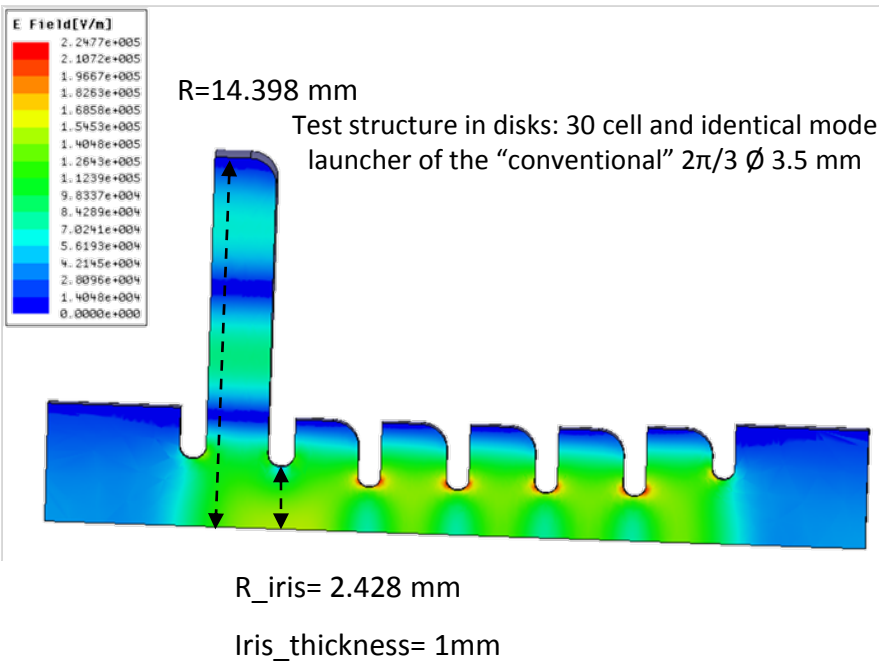

Goal : « protect » the structure by lowering V_g in the first cell (usually the most damaged).

Tested in both direction :

- RF fed from the input (4.1×10^6 pulses, 2186 breakdown) → the speed bump plays its role
- RF from the output (1.7×10^6 pulses, 501 breakdown) → the speed bump has no effect

Speed bump (TM₀₃) - results

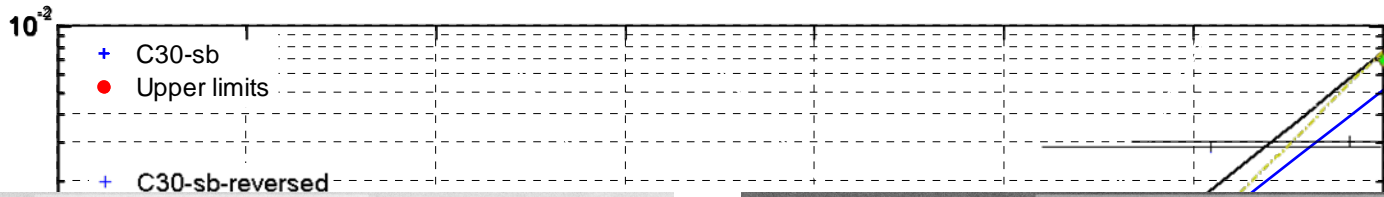

Standard disc 1

Standard disc 28

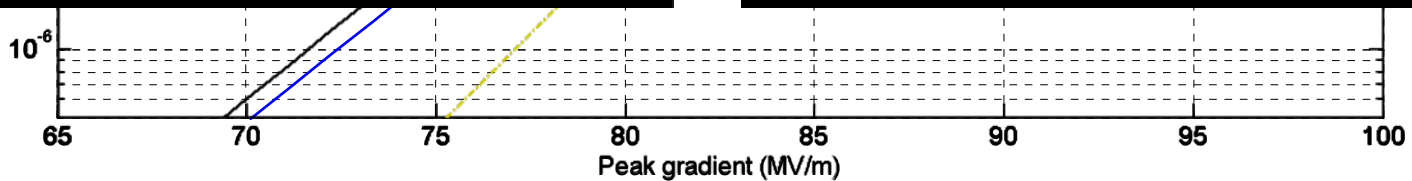
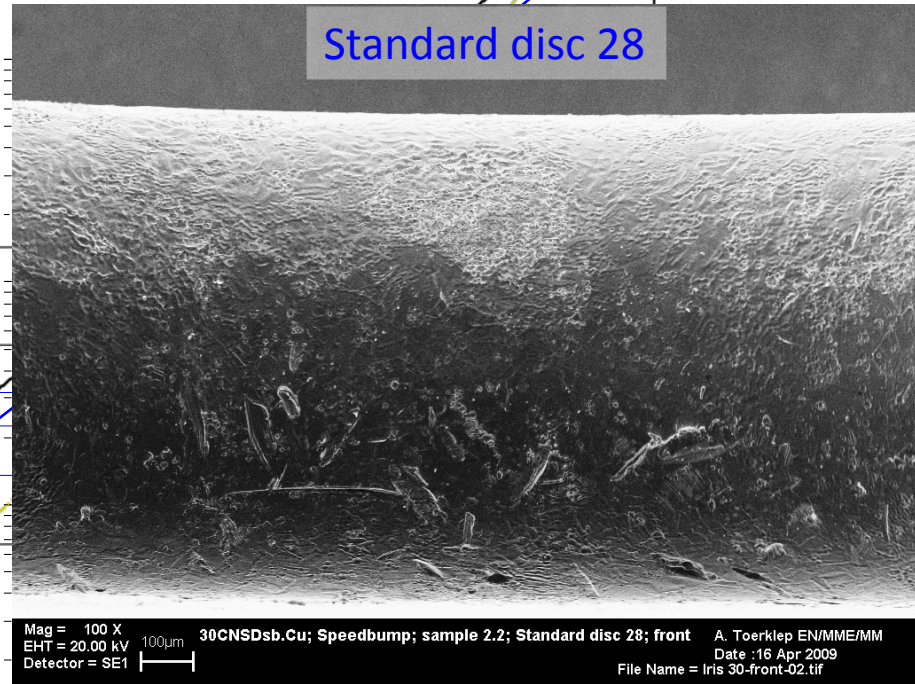
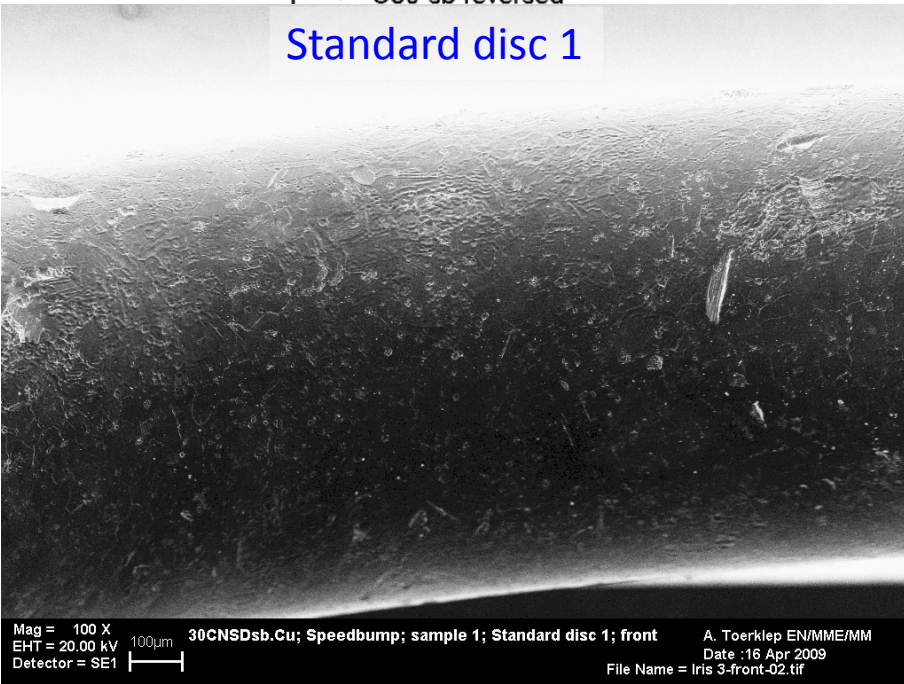

No effect observed on the breakdown rate : similar results in both directions and for the 3.5 mm structure (same design without speed bump), but...

TM₀₂ structure – separate effect of group velocity and local fields

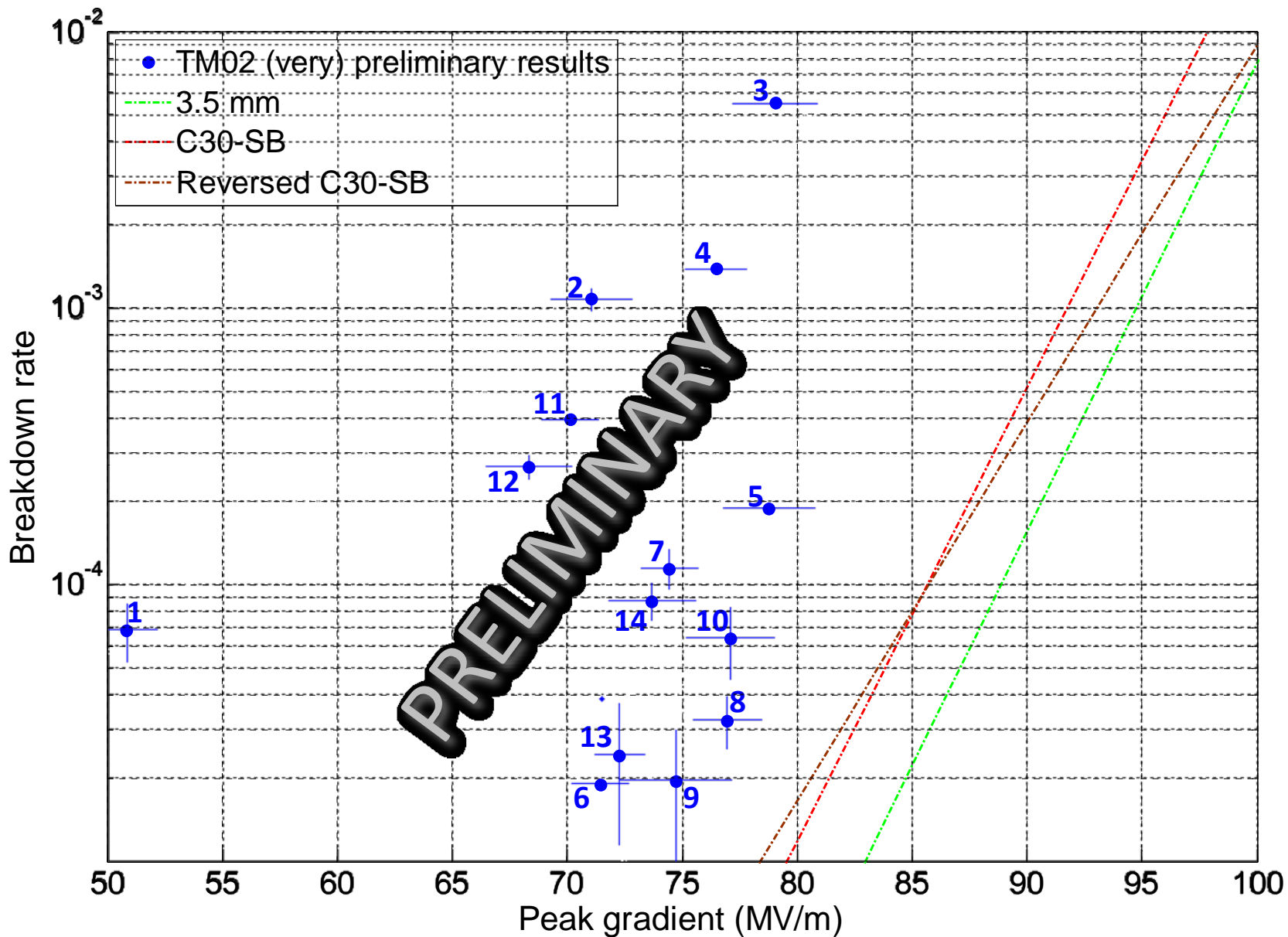

Dark current: Direct comparison between simulation and measurement in the T18 structure.

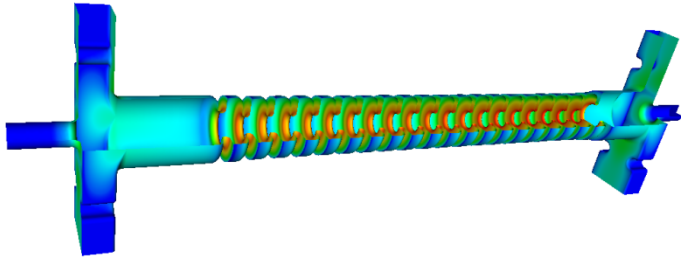

Simulation by SLAC ACG using Track3P. Fermilab is starting tracking simulation activities too.

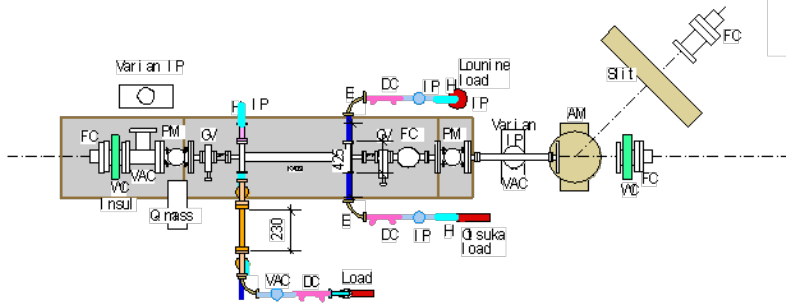
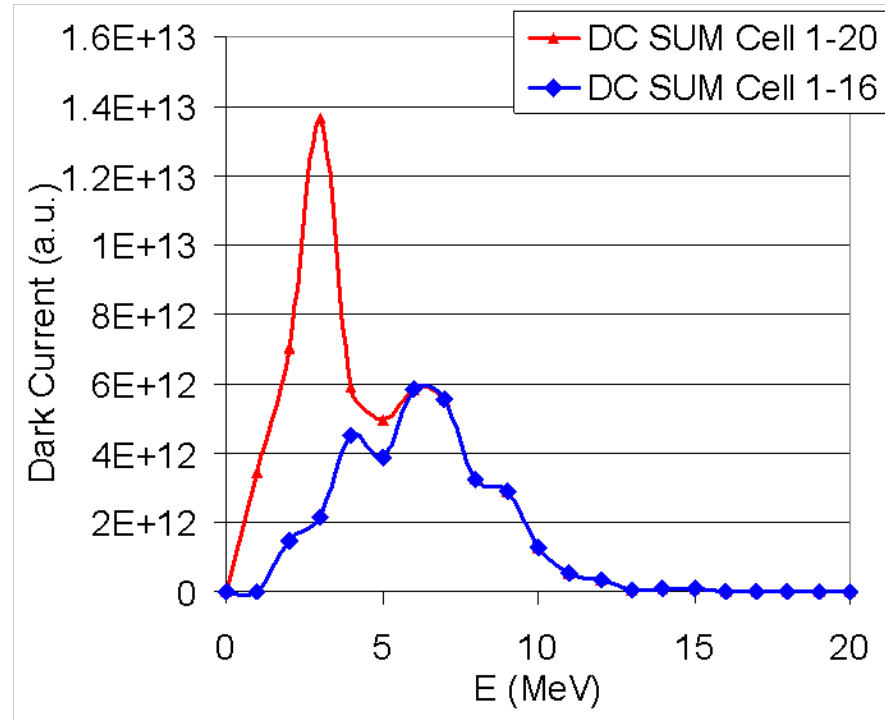

Measured at KEK

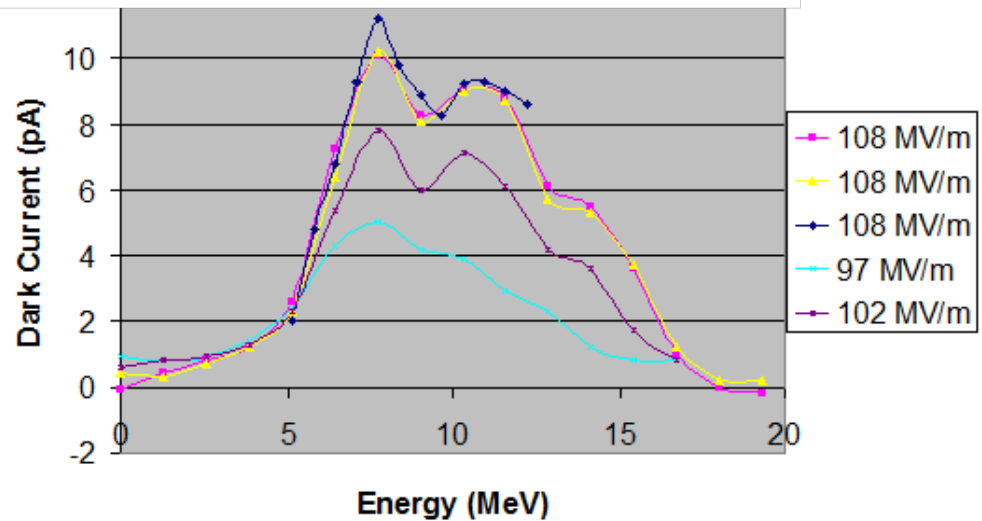



HELSINGIN YLIOPISTO
HELSINGFORS UNIVERSITET
UNIVERSITY OF HELSINKI

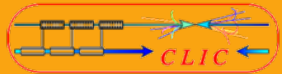

Multiscale Modelling of Vacuum Arcs in Breakdowns

*Flyura Djurabekova, Helga Timkó,
Kai Nordlund*

Helsinki Institute of Physics and CERN



Multiscale model

Our model corresponds to the above 3 phases.

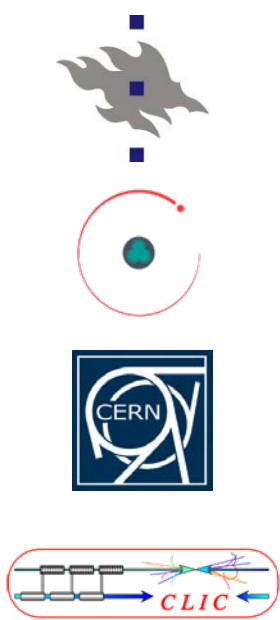

Stage 1: Charge distribution at the surface
Method: DFT with external electric field

Stage 2: Atomic motion & evaporation
Method: Hybrid ED&MD model

Classical MD

Solution of Laplace equation

Stage 3: Evolution of surface morphology due to the given charge distribution
Method: Kinetic Monte Carlo

Onset of plasma

Feedback: Electron & ion & cluster emission ions

Stage 4: Plasma evolution, burning of arc
Method: Particle-in-Cell (PIC)

Feedback: Energy & flux of bombarding ions

Stage 5: Surface damage due to the intense ion bombardment from plasma
Method: Arc MD

Achievements

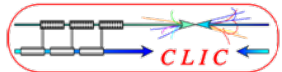
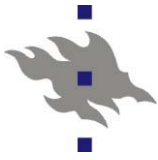

1. **Onset:** direct field evaporation from surfaces and tips could be simulated
2. **Plasma build-up:** currently under development is a 1D PIC code (from MPG) that used a simplified model; now we are modelling the experimental DC setup including

- All possible collisions, experimental and simulated sputtering yields, secondary electron yield
- Dynamic field emission and erosion of the tip

3. **Cratering:** using PIC input (flux & energy distribution of incident ions), erosion and sputtering was simulated

- Comparing arc plasma bombardment and thermal heating, we found that:

- \exists threshold, corresp. to the melting point
- Only in the case of plasma bombardment we see a heat spike & cluster emission above the threshold and experimentally seen complex crater shapes can form

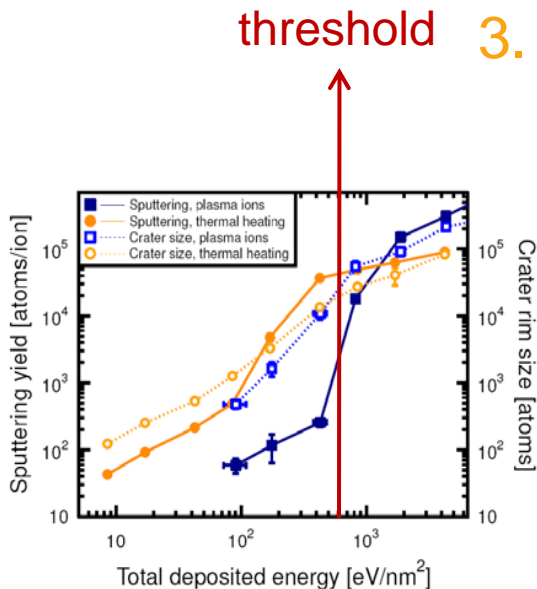

Comparison between effect of thermal heating and ion bombardment on surface – same amount of energy but different mechanism

Damage caused by thermal heating in Cu, 200 ions, on $r = 15$ nm spot

DC arc plasma damage in Cu, 200 ions, on $r = 15$ nm spot

time 0.0041 ps

time 0.0041 ps

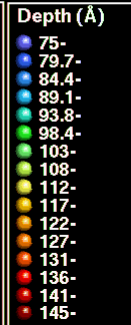
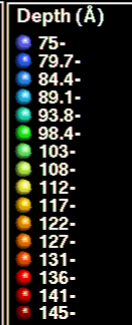

x (-600 - 600) y (-50 - 750) z (-600 - 600)

Helga Timkó (2009)

x (-600 - 600) y (-50 - 750) z (-600 - 600)

Helga Timkó (2009)

The connection between simulation and experiment

Emitted currents

- Dark current spectrum
- OTR
- X-rays
- Trigger mechanism
- Missing energy
- Breakdown rate
- Ion currents
- Fowler-Nordheim distribution

Plasma characteristics

- Time structure
- Physical dimension (imaging)
- Ion species (opt. spectroscopy)
- Ion currents
- Vacuum behaviour

Surfaces

- Crater morphology
- Material diagnostics
- Fatigue process

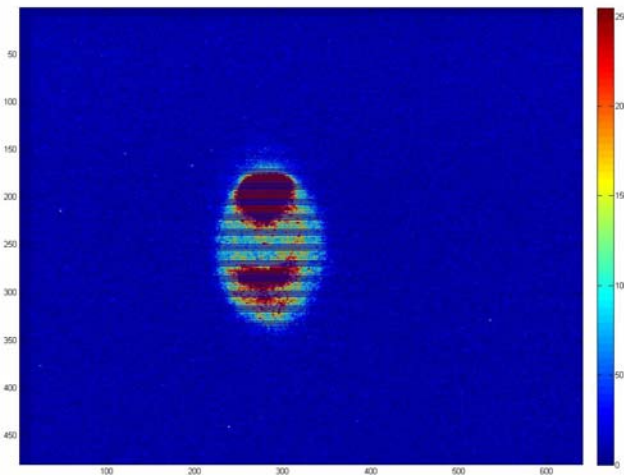

Breakdown diagnostics

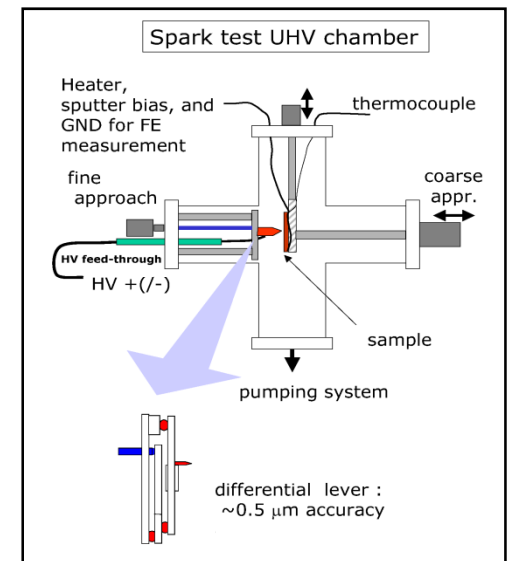

Breakdown diagnostics: some results

RF

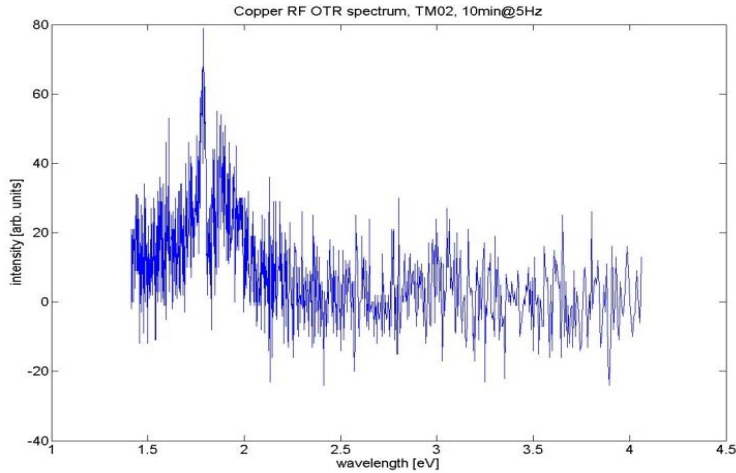

DC

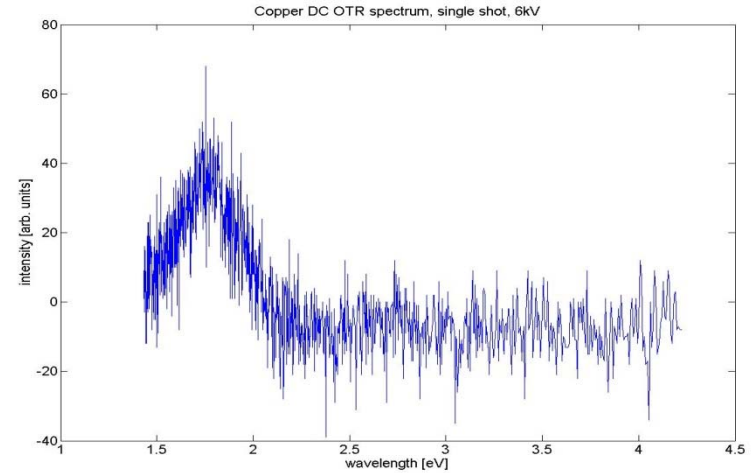

OTR (Copper)

Opt. spectroscopy

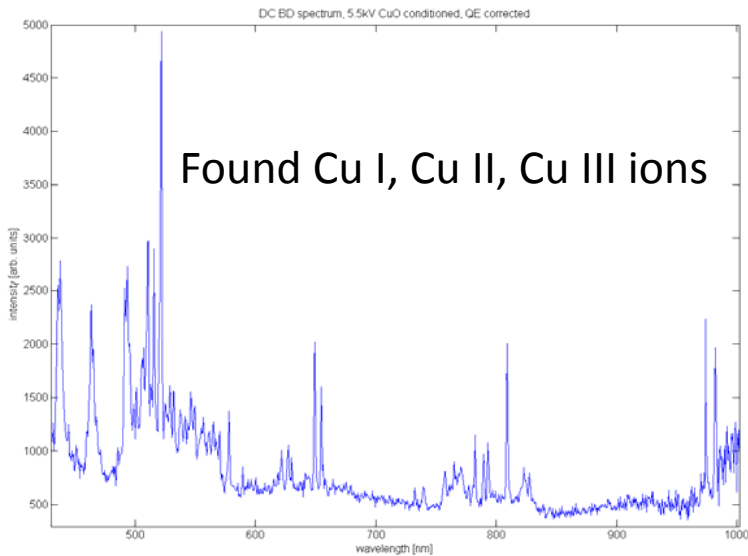

Will be measured soon at



Breakdown diagnostics: further measurements

RF (I,Q), Xray, FC @30GHz

RF

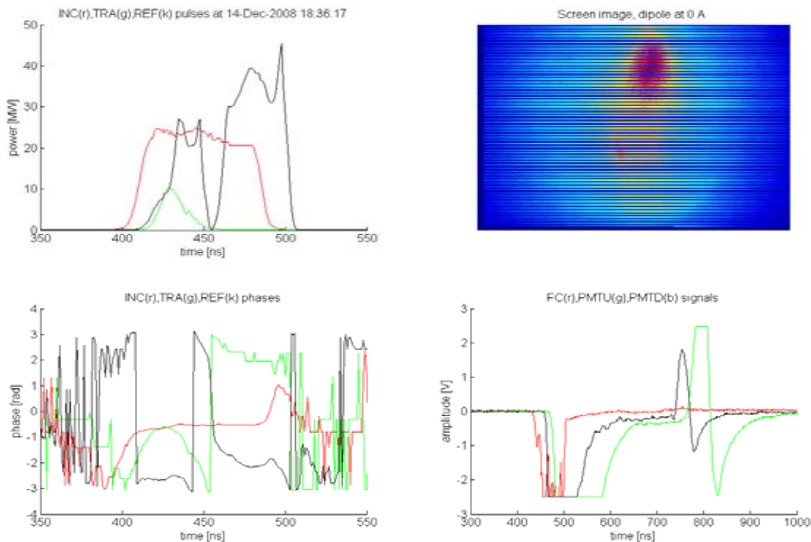

DC

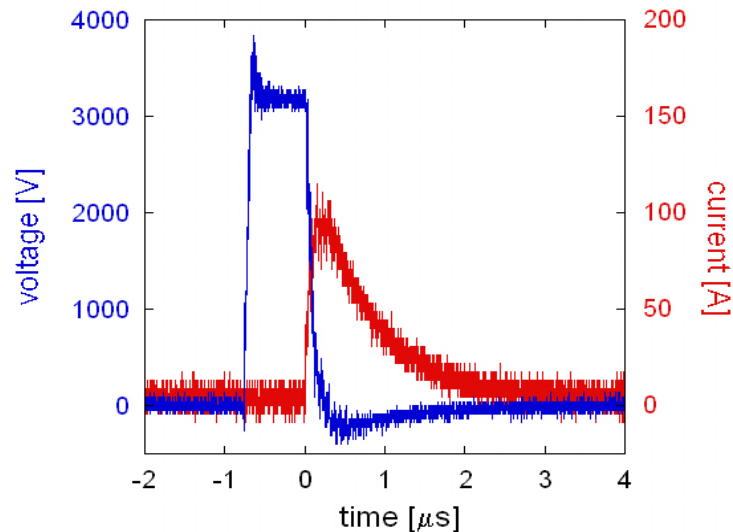

Current, voltage and delay

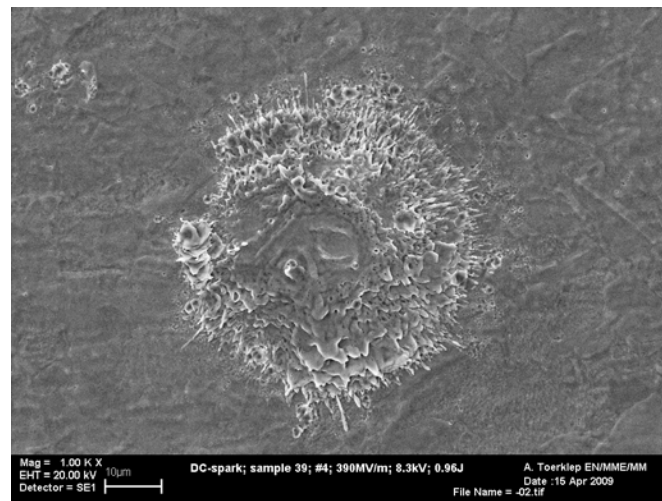
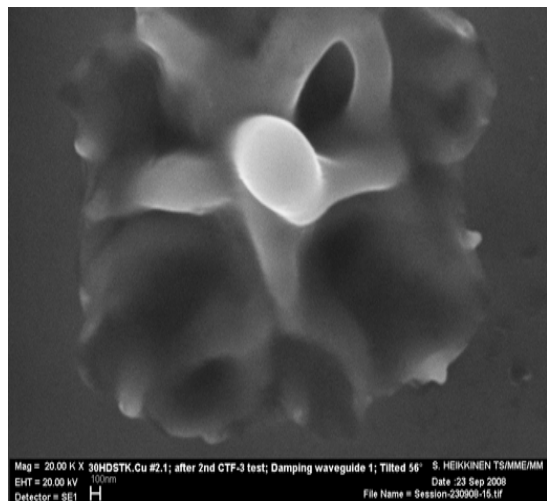

SEM of single breakdowns