

Bevezetés a részecskefizikába

*Előadássorozat fizikatanárok részére
(CERN, 2009)*

Horváth Dezső

horvath@rmki.kfki.hu

MTA KFKI Részecske- és Magfizikai Kutatóintézet, Budapest
és ATOMKI, Debrecen



Bevezetés a részecskefizikába 2

Vázlat

C. A Standard Modell ellenőrzése















- LEP és LHC
- Kalorimetria
- Jellegzetes események
- Z-szélesség és a 3 család
- Higgs-keresés

D. Szimmetriák és sértésük

- Tükrözési szimmetriák
- A paritássértés felfedezése
- Kaonfizika és CP-sértés
- CPT-invariancia és ellenőrzése



A Standard Modell állatkertje

Quarks		Leptons		Bosons
 up	 down	 electron	 neutrino e	 photon
 charm	 strange	 muon	 neutrino μ	 gluon
 top	 beauty	 tau	 neutrino τ	 Z^0 W^\pm
				 Higgs

The Standard Model

A. Pich - CERN Summer Lectures 2005



A CERN gyorsítói

LEP 2000-ig

LHC 2008-tól

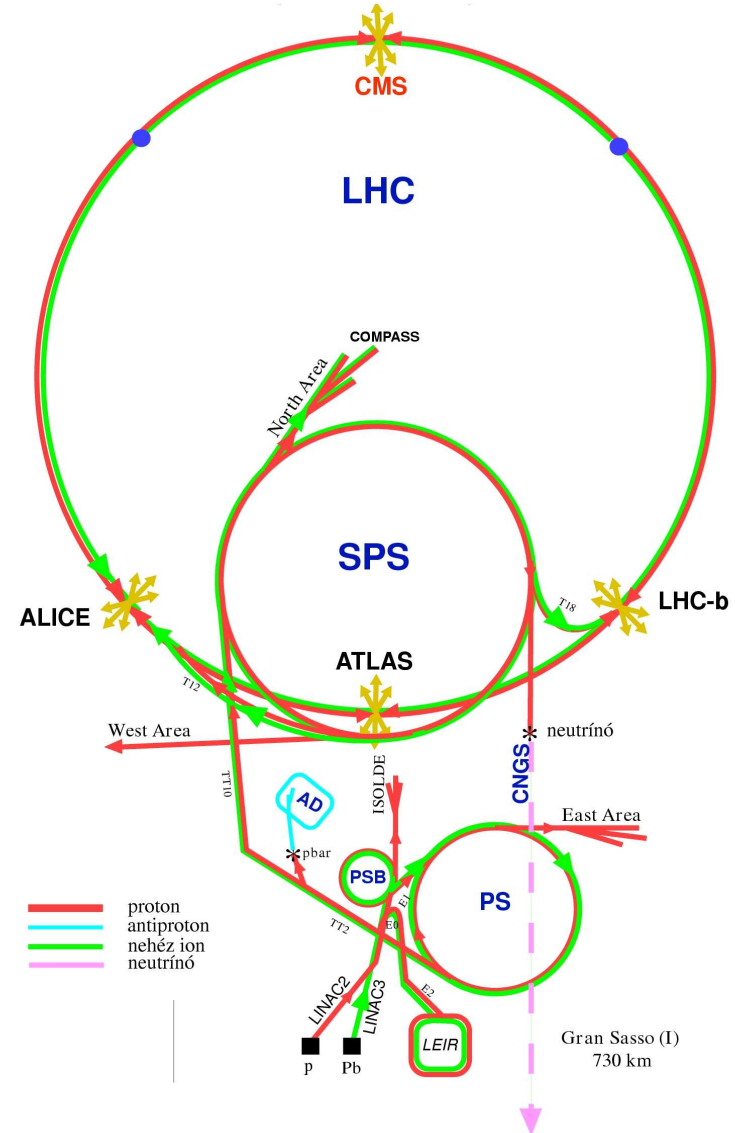
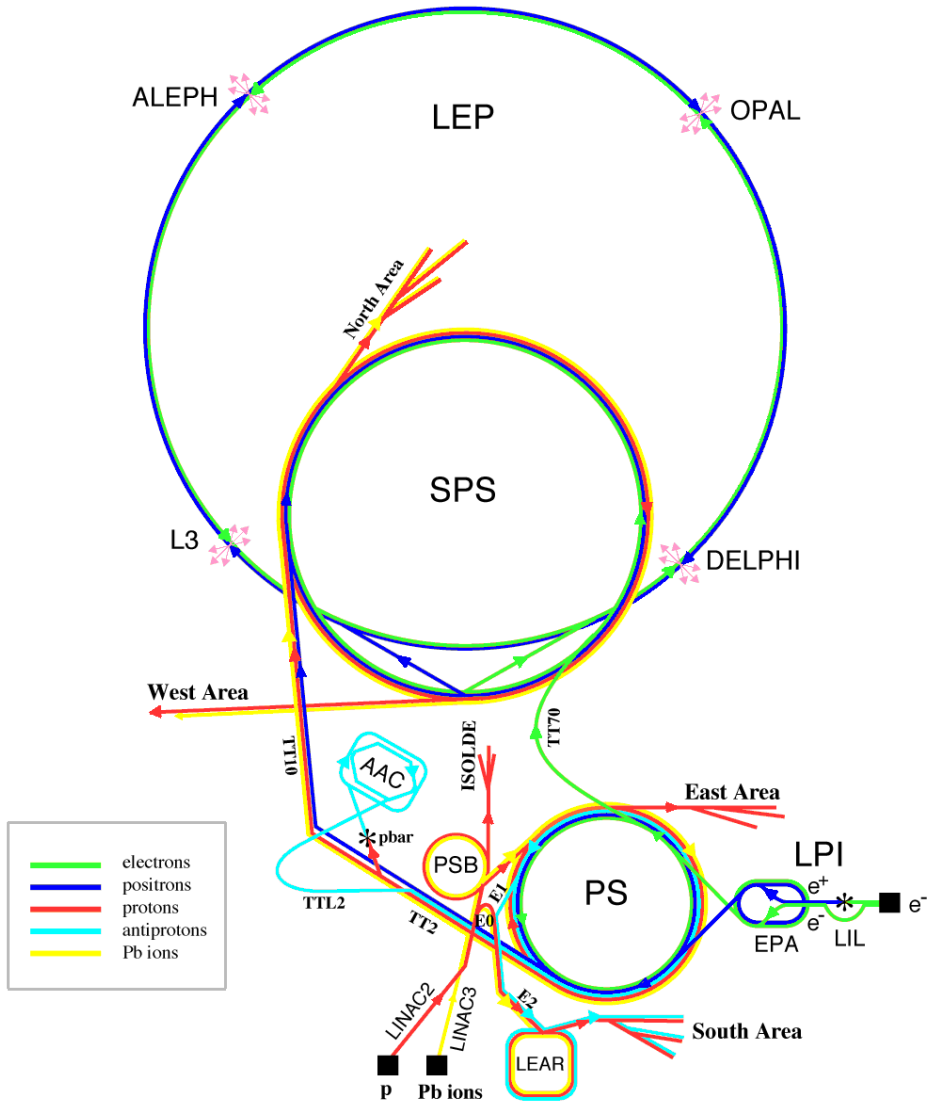

A néhai LEP-gyorsító



Kalorimetria: a CMS-detektor szelete

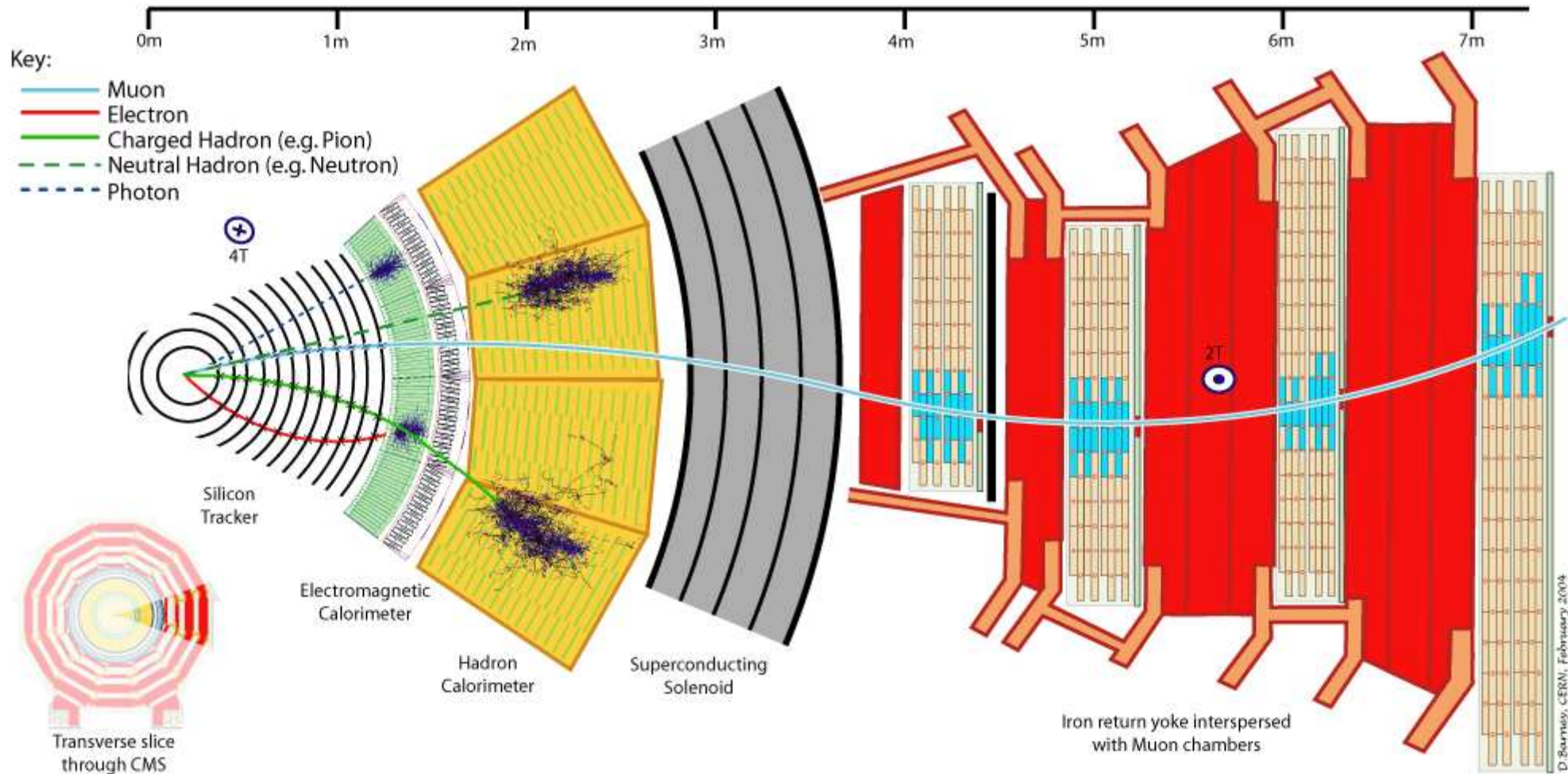

A néhai **OPAL**
detektor

Omni-Purpose
Apparatus for LEP

Large Electron
Positron collider,
1989–2000

10 m
×
Ø10 m

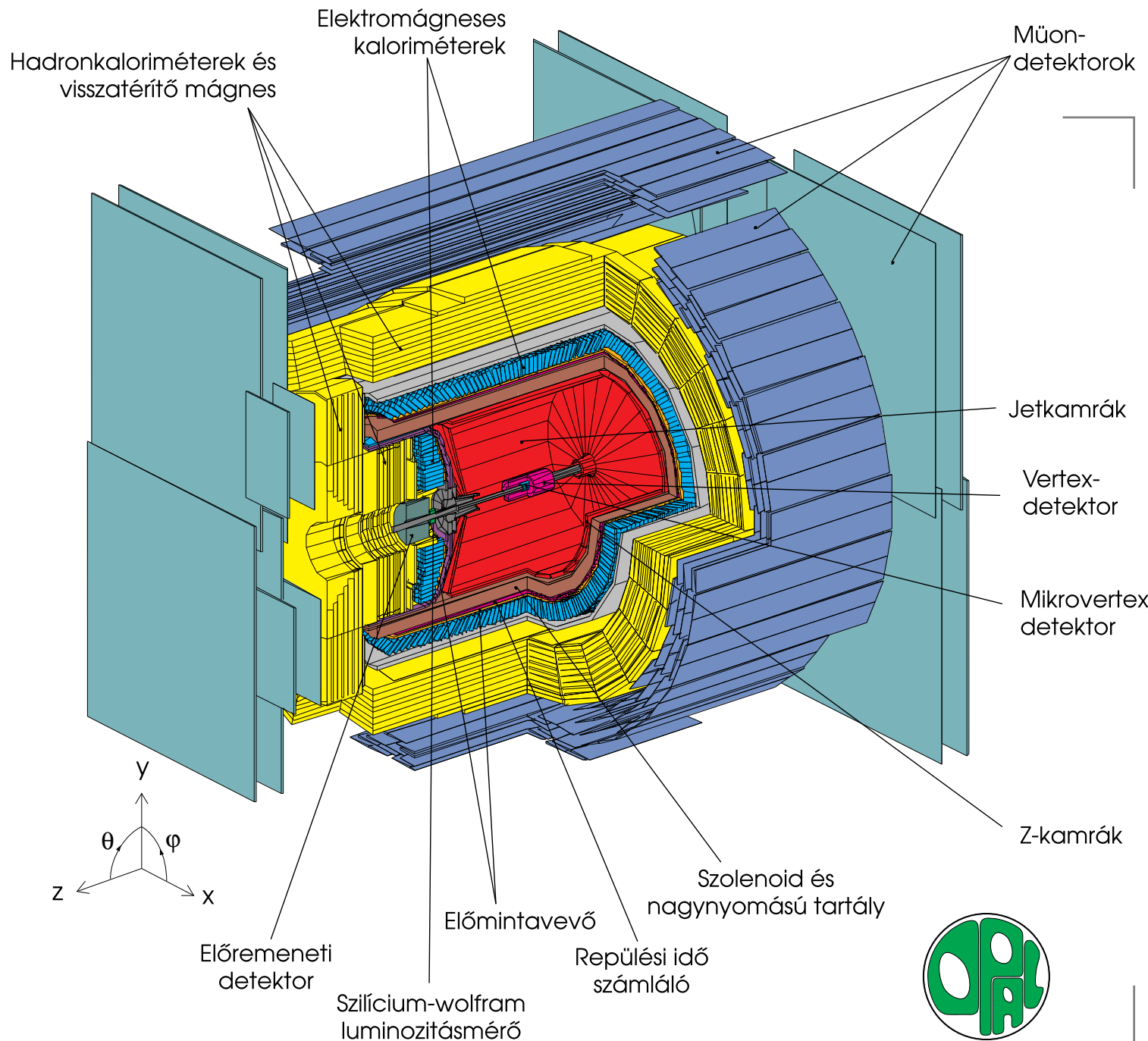

LEP-események

$$e^+e^- \rightarrow Z^* \rightarrow \dots$$

pontszerű leptonok
ütközése

tiszta folyamatok

Tipikus OPAL-esemény

$$e^+e^- \rightarrow W^+W^-$$



4 kvark



4 hadronzárpor



75 töltött részecske

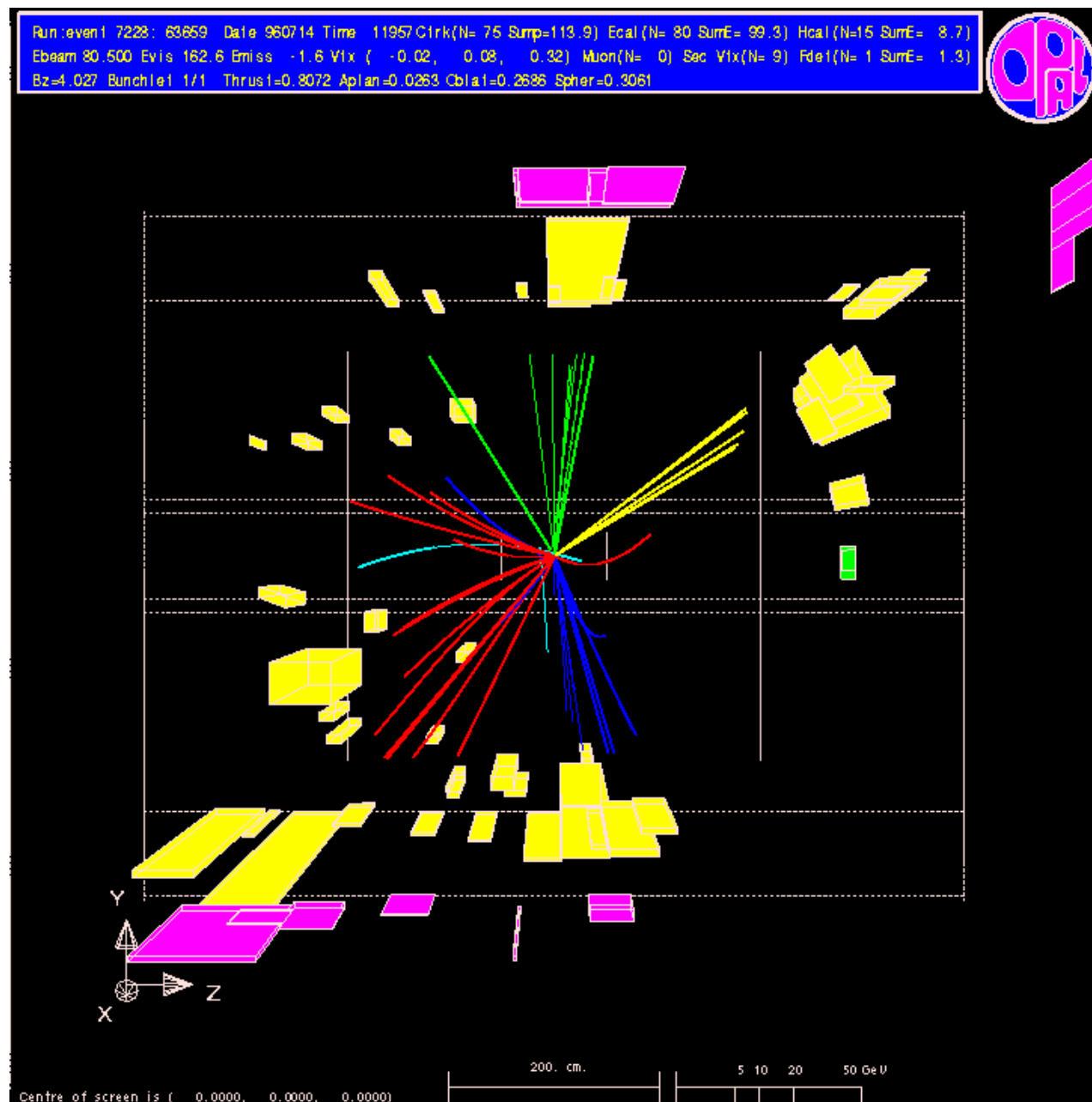

Ez milyen LEP-esemény?

Run: event 4093: 1150 Date 930527 Time 20751 Clrk(N= 2 Sump= 92.4) Ecal(N= 9 SumE= 90.5) Hcal(N= 0 SumE= 0.0)
Ebeam 45.658 Evis 94.4 Emiss -3.1 Vtx (-0.05, 0.08, 0.36) Muon(N= 0) Sec Vtx(N= 0) Fdet(N= 1 SumE= 0.0)
Bz=4.350 Thrust=0.9979 Aplan=0.0000 Oblat=0.0039 Spher=0.0001

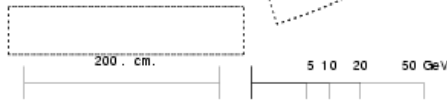
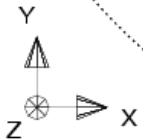
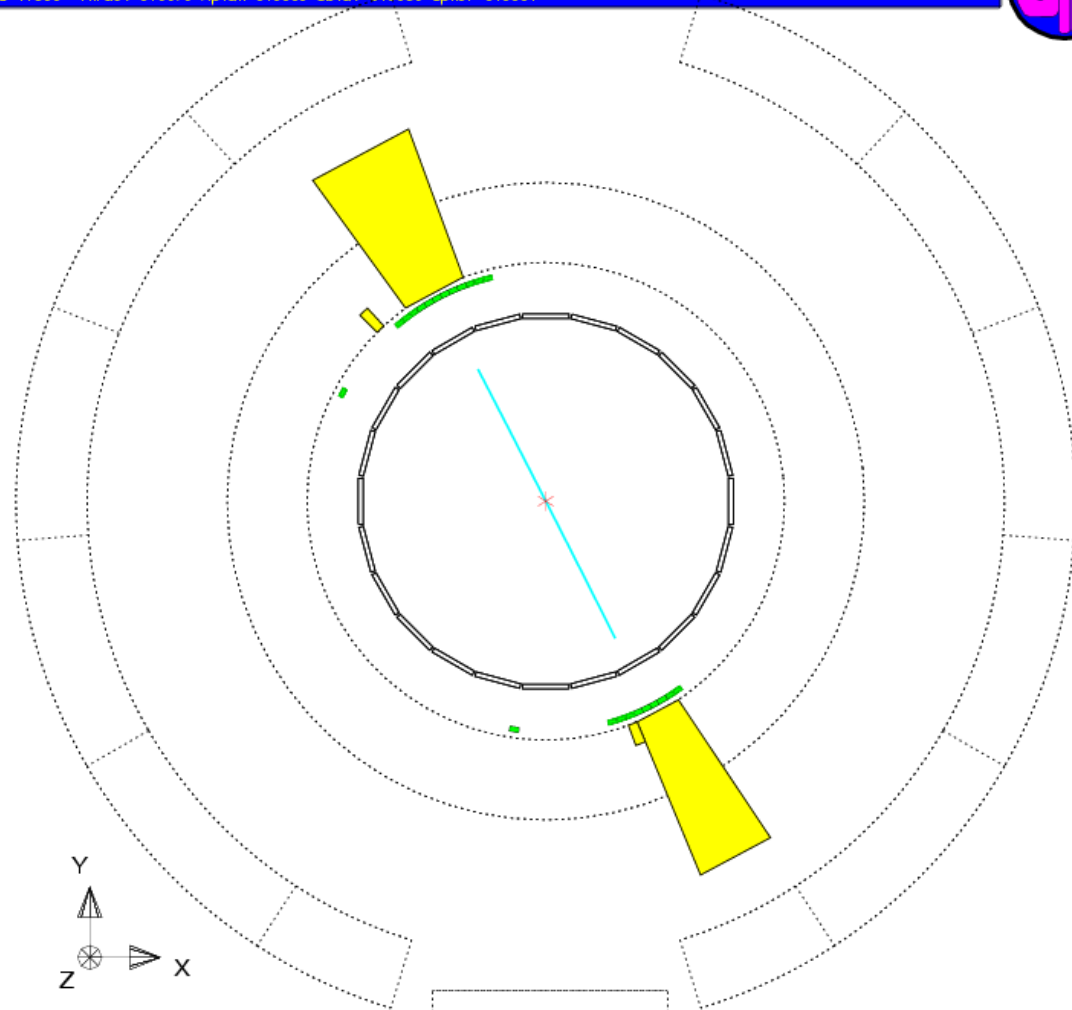

Centre of screen is (0.0000, 0.0000, 0.0000)



Ez milyen LEP-esemény?

Run: event 4093: 1150 Date 930527 Time 20751 Ctrk(N= 2 Sump= 92.4) Ecal(N= 9 SumE= 90.5) Hcal(N= 0 SumE= 0.0)
Ebeam 45.658 Evis 94.4 Emiss -3.1 Vtx (-0.05, 0.08, 0.36) Muon(N= 0) Sec Vtx(N= 0) Fdet(N= 1 SumE= 0.0)
Bz=4.350 Thrust=0.9979 Aplan=0.0000 Oblat=0.0039 Spher=0.0001

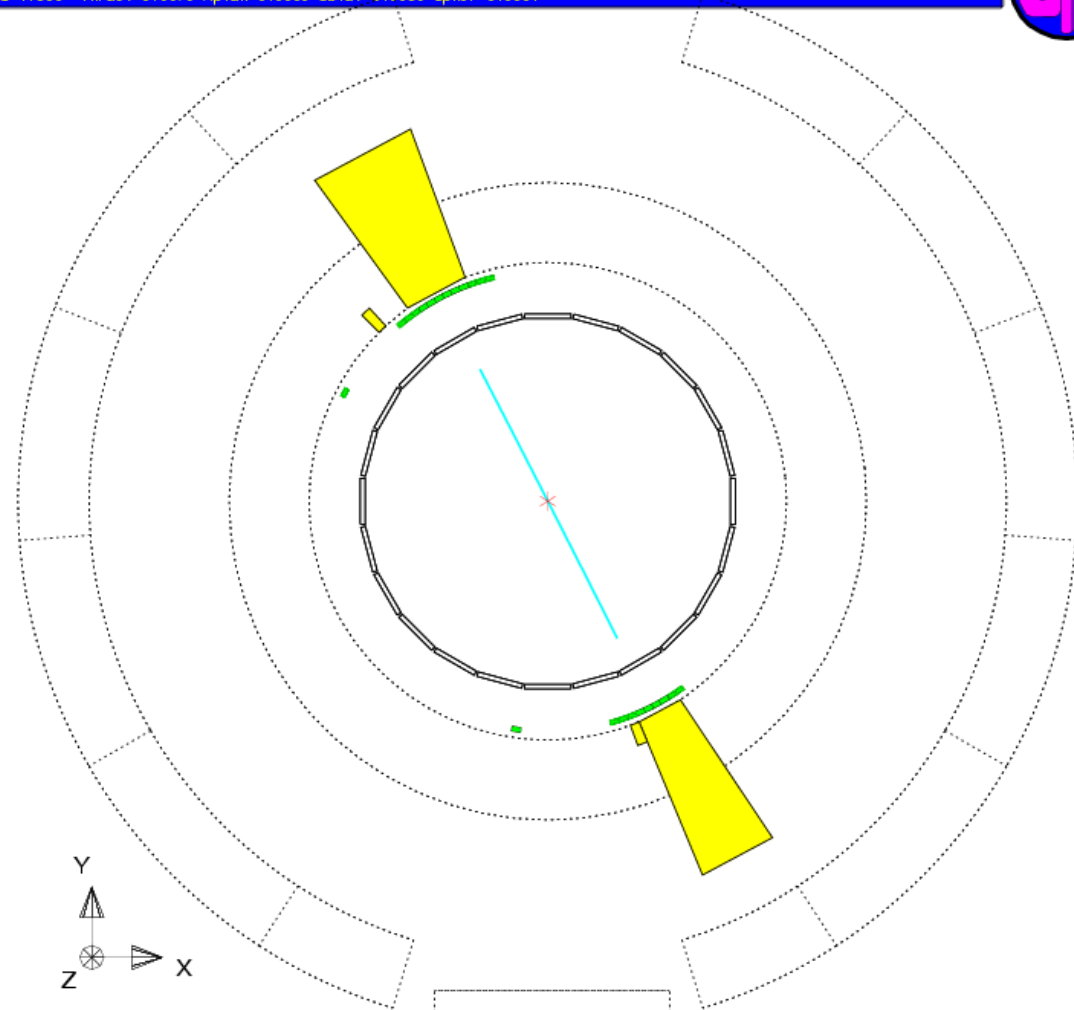

Centre of screen is (0.0000, 0.0000, 0.0000)

OPAL

$$e^+e^- \rightarrow e^+e^-$$

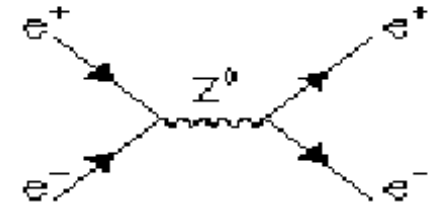

Ez milyen LEP-esemény?

Run: event 4093: 1042 Date 930527 Time 20724 Ctrk(N= 2 Sump= 91.4) Ecal(N= 8 SumE= 5.0) Hcal(N= 4 SumE= 6.9)
Ebeam 45.658 Evis 101.0 Emiss -9.6 Vtx (-0.05, 0.08, 0.36) Muon(N= 2) Sec Vtx(N= 0) Fdet(N= 1 SumE= 0.0)
Bz=4.350 Thrust=0.9945 Aplan=0.0000 Oblat=0.0304 Spher=0.0013

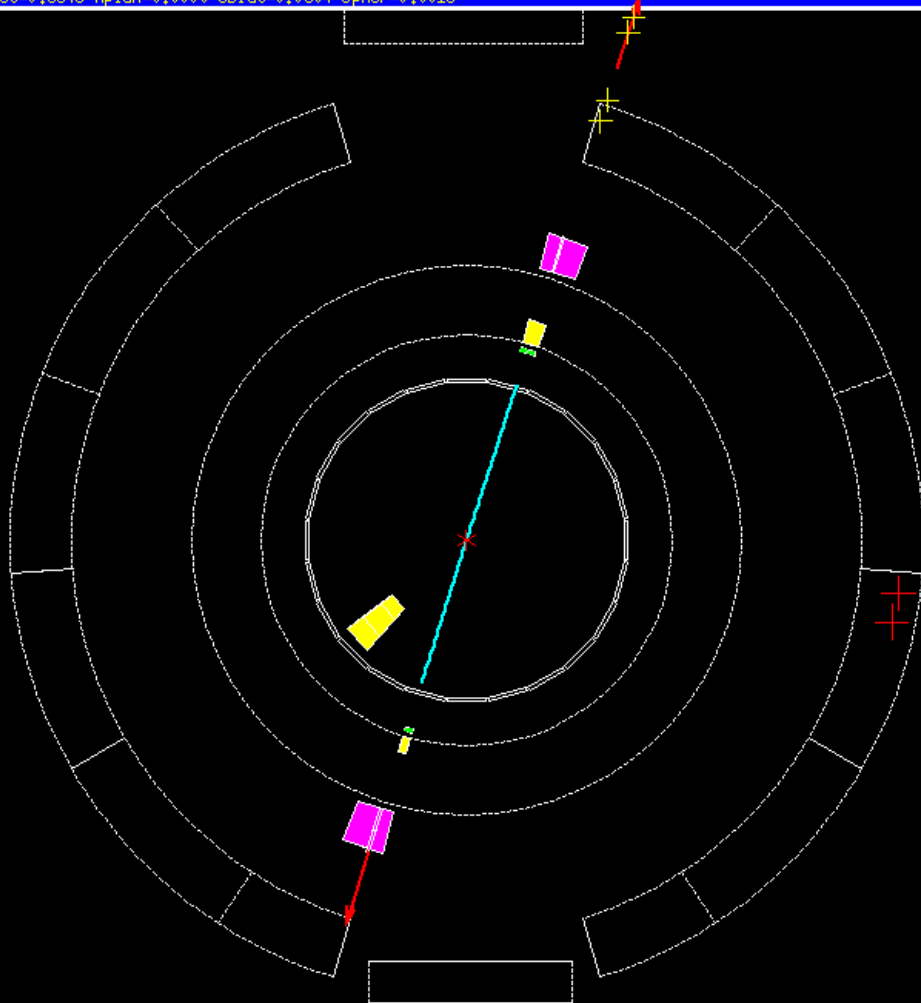

Centre of screen is (0.0000, 0.0000, 0.0000)

Ez milyen LEP-esemény?

Run: event 4093: 1042 Date 930527 Time 20724 Ctrk(N= 2 Sump= 91.4) Ecal(N= 8 SumE= 5.0) Hcal(N= 4 SumE= 6.9)
 Ebeam 45.658 Evis 101.0 Emiss -9.6 Vtx (-0.05, 0.08, 0.36) Muon(N= 2) Sec Vtx(N= 0) Fdet(N= 1 SumE= 0.0)
 Bz=4.350 Thrust=0.9945 Aplan=0.0000 Oblat=0.0304 Spher=0.0013

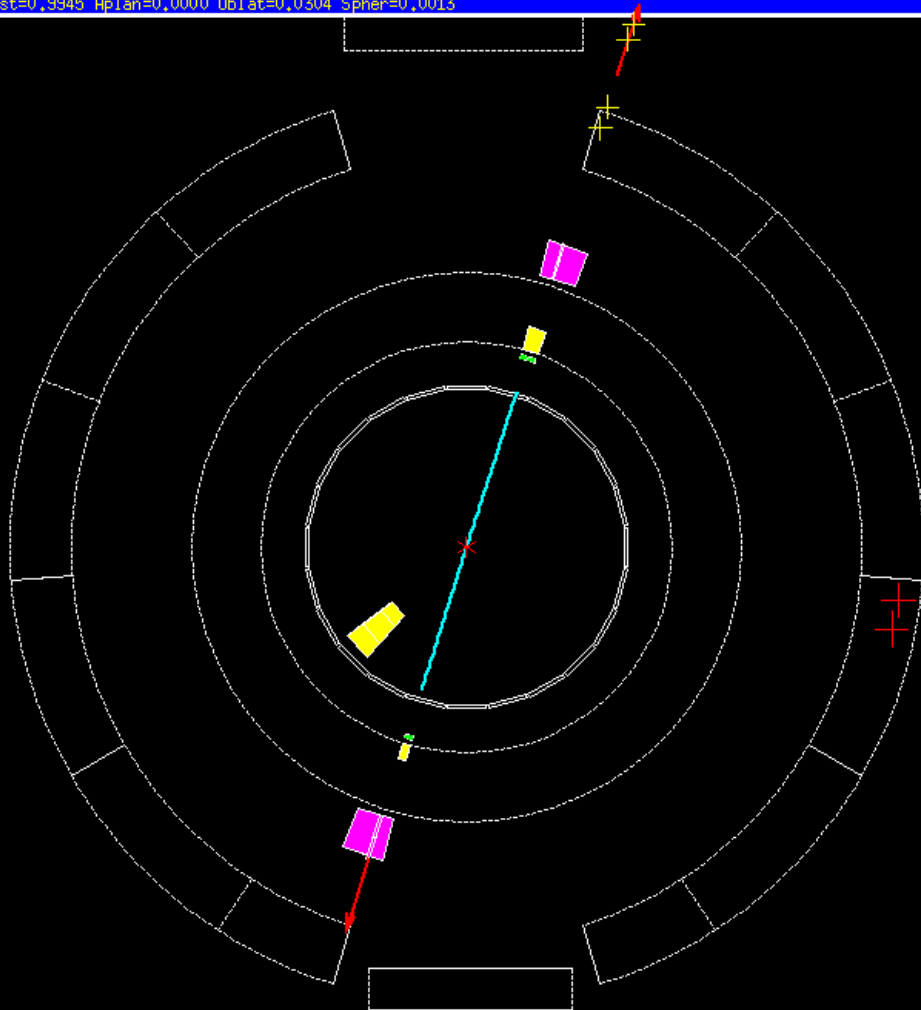

OPAL

$$e^+e^- \rightarrow \mu^+\mu^-\gamma$$

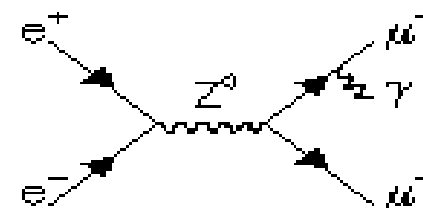

Centre of screen is (0.0000, 0.0000, 0.0000)

200. cm. 510 20 50 GeV

Ez milyen LEP-esemény?

Run: event 3223: 7994 Date: 920708 Time: 10856 Ctrk(N)= 4 Sump= 91.9) Ecal(N)= 6 SumE= 4.0) Hcal(N)= 4 SumE= 4.3)
Ebeam 45.652 Evis 96.2 Emiss -4.9 Vtx (0.02, 0.06, 0.44) Muon(N)= 11) Sec Vtx(N)= 0) Fdet(N)= 0 SumE= 0.0)
Bz=4.350 Thrust=0.8343 Aplan=0.0009 Oblat=0.3971 Spher=0.3149

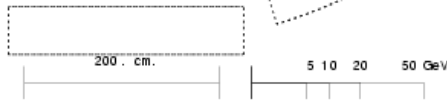
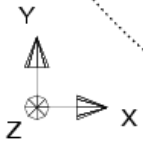
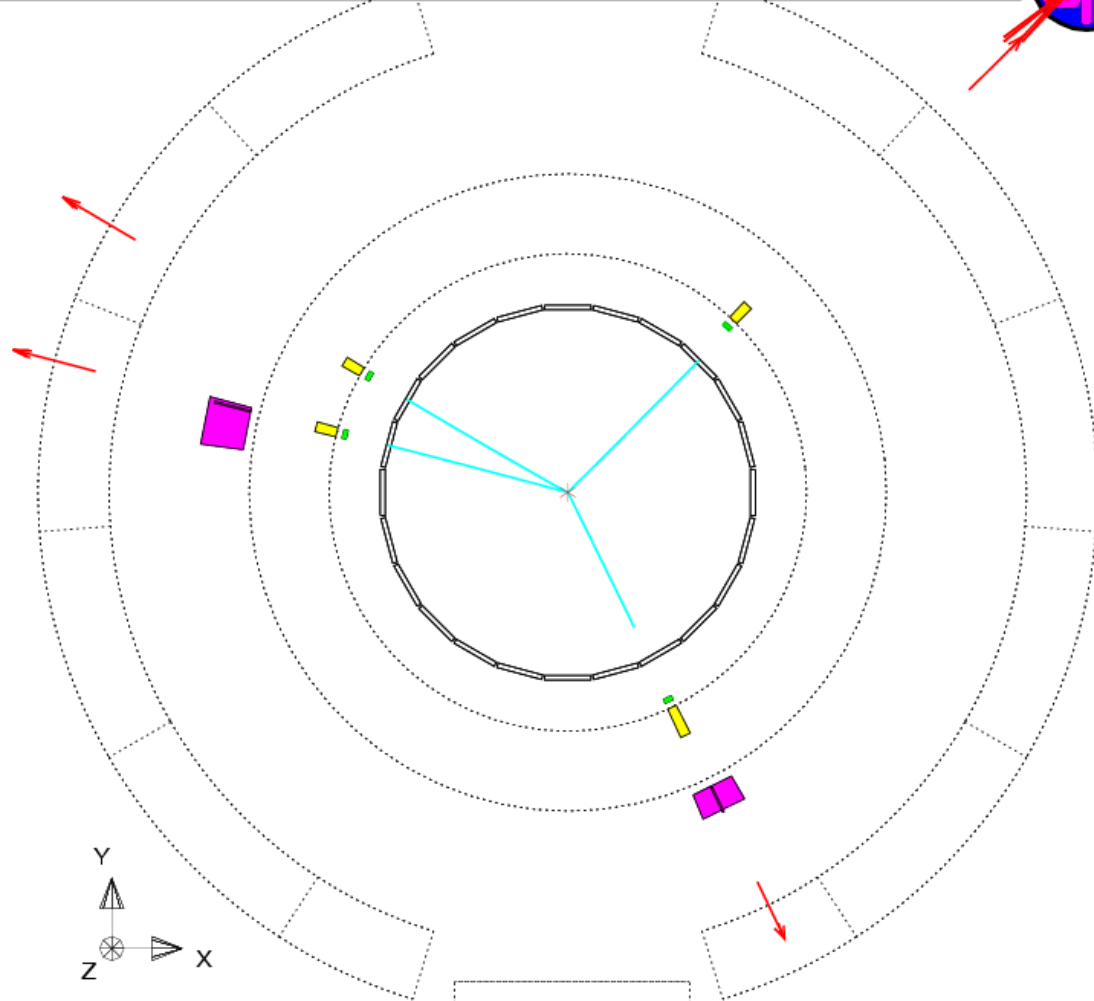

Centre of screen is (0.0000, 0.0000, 0.0000)



Ez milyen LEP-esemény?

Run: event 3223: 7994 Date: 920708 Time: 10856 Ctrk(N)= 4 Sump= 91.9) Ecal(N)= 6 SumE= 4.0) Hcal(N)= 4 SumE= 4.3)
 Ebeam 45.652 Evis 96.2 Emiss -4.9 Vtx (0.02, 0.06, 0.44) Muon(N)= 11) Sec Vtx(N)= 0) Fdet(N)= 0 SumE= 0.0)
 Bz=4.350 Thrust=0.8343 Aplan=0.0009 Oblat=0.3971 Spher=0.3149

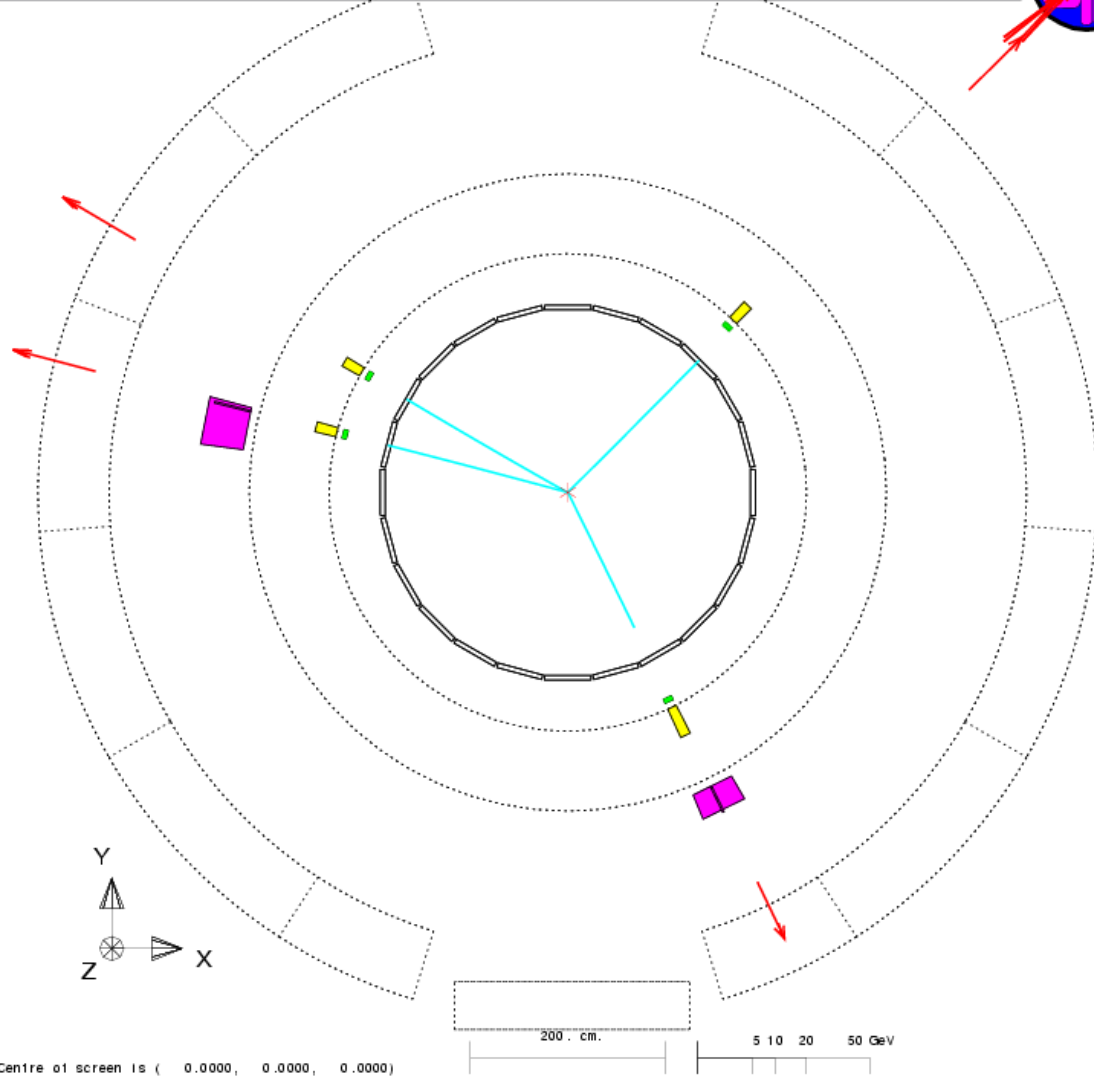

OPAL

$$e^+e^- \rightarrow \mu^+\mu^-\mu^+\mu^-$$

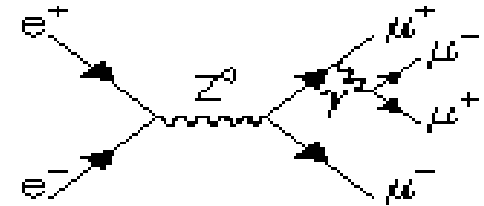

Ez milyen LEP-esemény?

Run: event 4177: 49573 Date 930611 Time 203852 Ctrk(N= 2 Sump= 50.6) Ecal(N= 4 SumE= 26.8) Hcal(N= 2 SumE= 1.3)
Ebeam 45.661 Evis 52.1 Emiss 39.3 Vtx (-0.03, 0.08, 0.45) Muon(N= 1) Sec Vtx(N= 0) Fdet(N= 0 SumE= 0.0)
Bz=4.350 Thrust=0.9975 Aplan=0.0000 Oblat=0.0332 Spher=0.0020

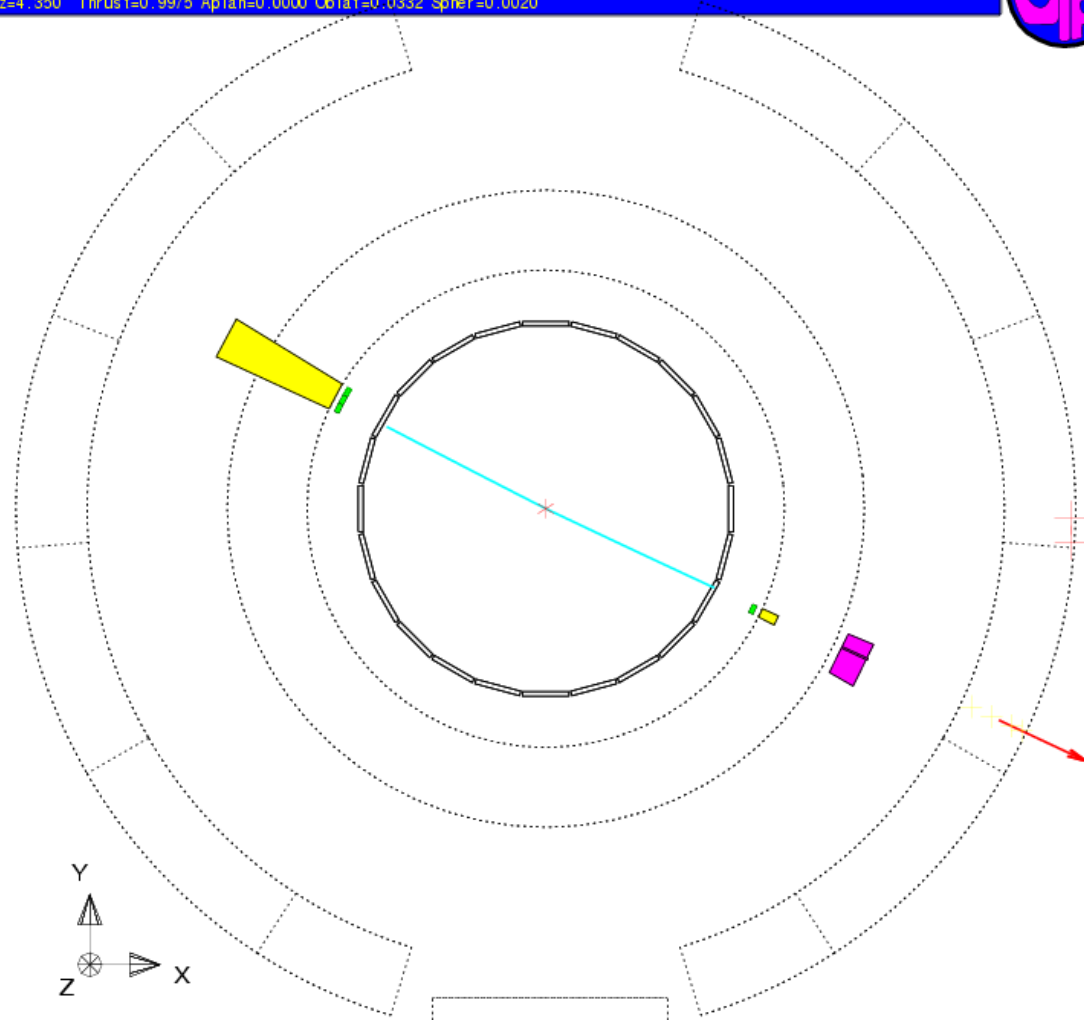

Centre of screen is (0.0000, 0.0000, 0.0000)

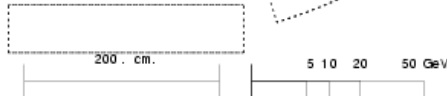

Ez milyen LEP-esemény?

Run: event 4177: 49573 Date 930611 Time 203852 Ctrk(N= 2 Sump= 50.6) Ecal(N= 4 SumE= 26.8) Hcal(N= 2 SumE= 1.3)
Ebeam 45.661 Evis 52.1 Emiss 39.3 Vtx (-0.03, 0.08, 0.45) Muon(N= 1) Sec Vtx(N= 0) Fdet(N= 0 SumE= 0.0)
Bz=4.350 Thrust=0.9975 Aplan=0.0000 Oblat=0.0332 Spher=0.0020

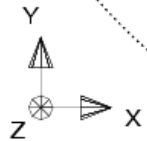
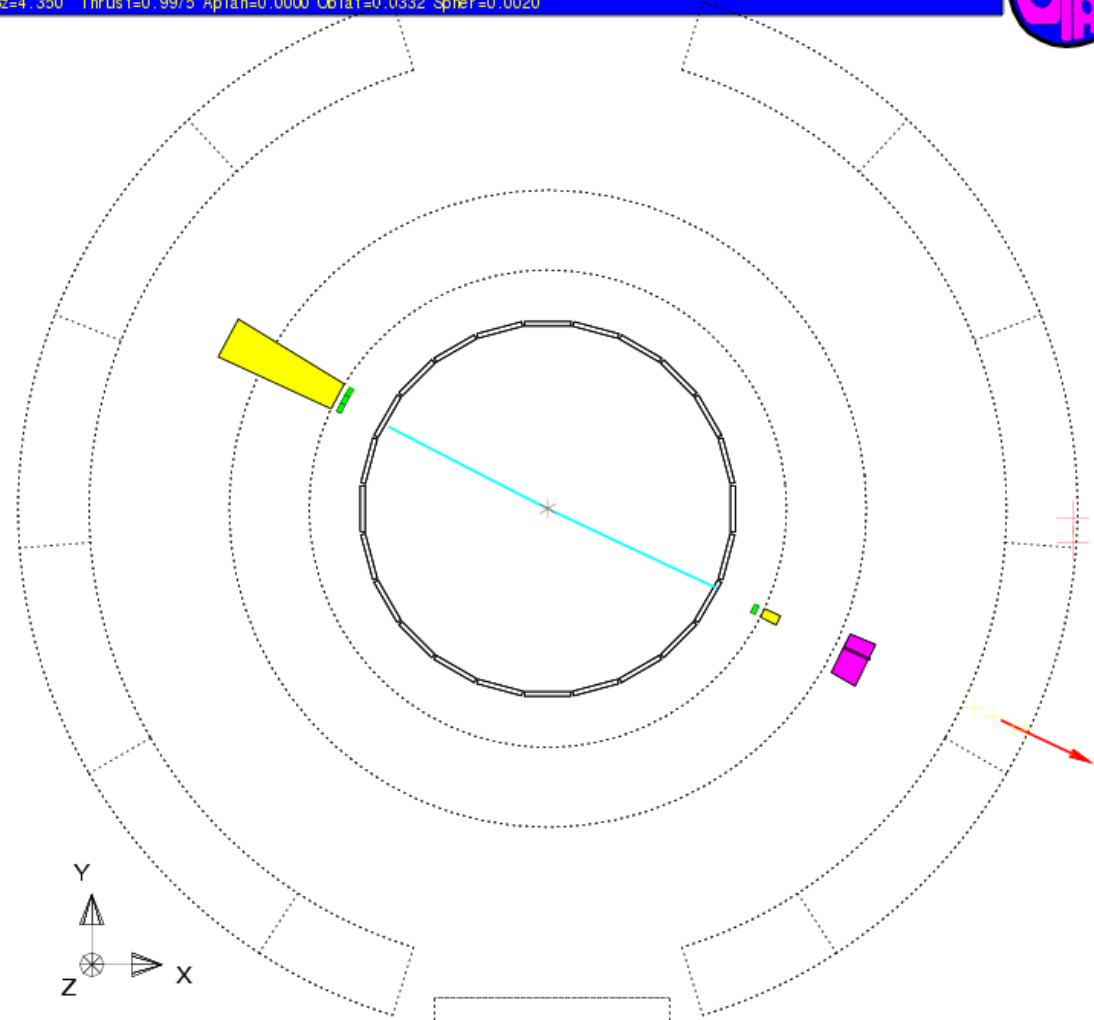

Centre of screen is (0.0000, 0.0000, 0.0000)

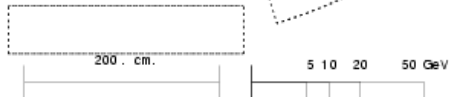

OPAL

$$e^+e^- \rightarrow \tau^+\tau^- \rightarrow \mu\nu e\nu$$

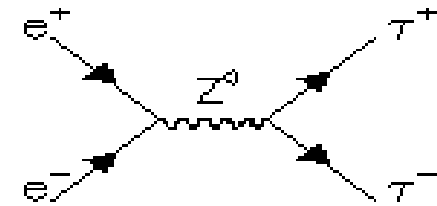

Ez milyen LEP-esemény?

Run: event 4177:115034 Date: 930612 Time: 10314 Ctrk(N)= 0 Sump= 0.0) Ecal(N)= 8 SumE= 97.4) Hcal(N)= 1 SumE= 2.5)
Ebeam 45.661 Evis 99.6 Emiss -8.3 Vtx (-0.04, 0.08, 0.45) Muon(N)= 0) Sec Vtx(N)= 0) Fdet(N)= 0 SumE= 0.0)
Bz=4.350 Thrust=0.9957 Aplan=0.0000 Oblat=0.0285 Spher=0.0006

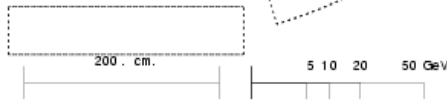
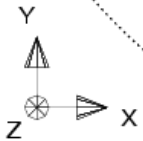
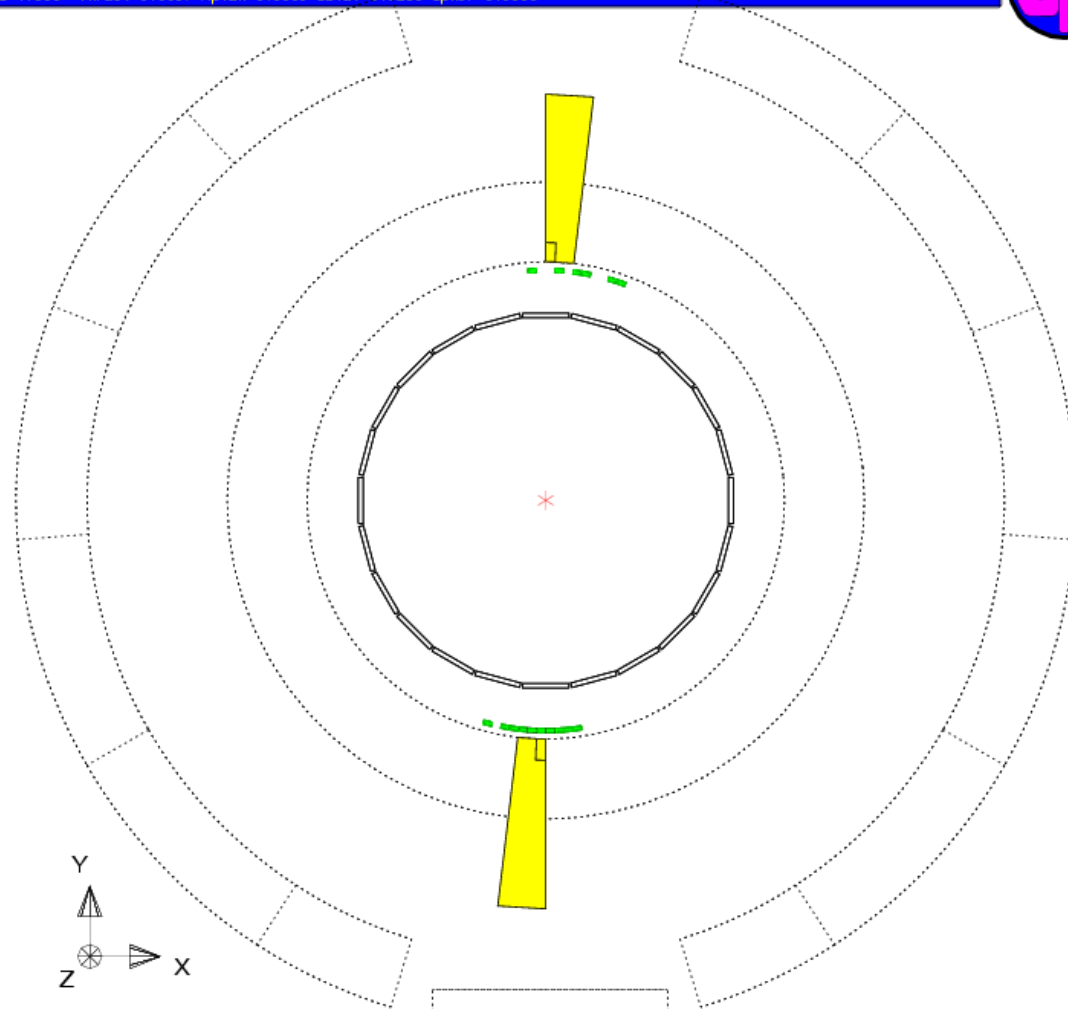

Centre of screen is (0.0000, 0.0000, 0.0000)



Ez milyen LEP-esemény?

Run: event 4177:115034 Date: 930612 Time: 10314 Ctrk(N)= 0 Sump= 0.0) Ecal(N)= 8 SumE= 97.4) Hcal(N)= 1 SumE= 2.5)
Ebeam 45.661 Evis 99.6 Emiss -8.3 Vtx (-0.04, 0.08, 0.45) Muon(N)= 0) Sec Vtx(N)= 0) Fdet(N)= 0 SumE= 0.0)
Bz=4.350 Thrust=0.9957 Aplan=0.0000 Oblat=0.0285 Spher=0.0006

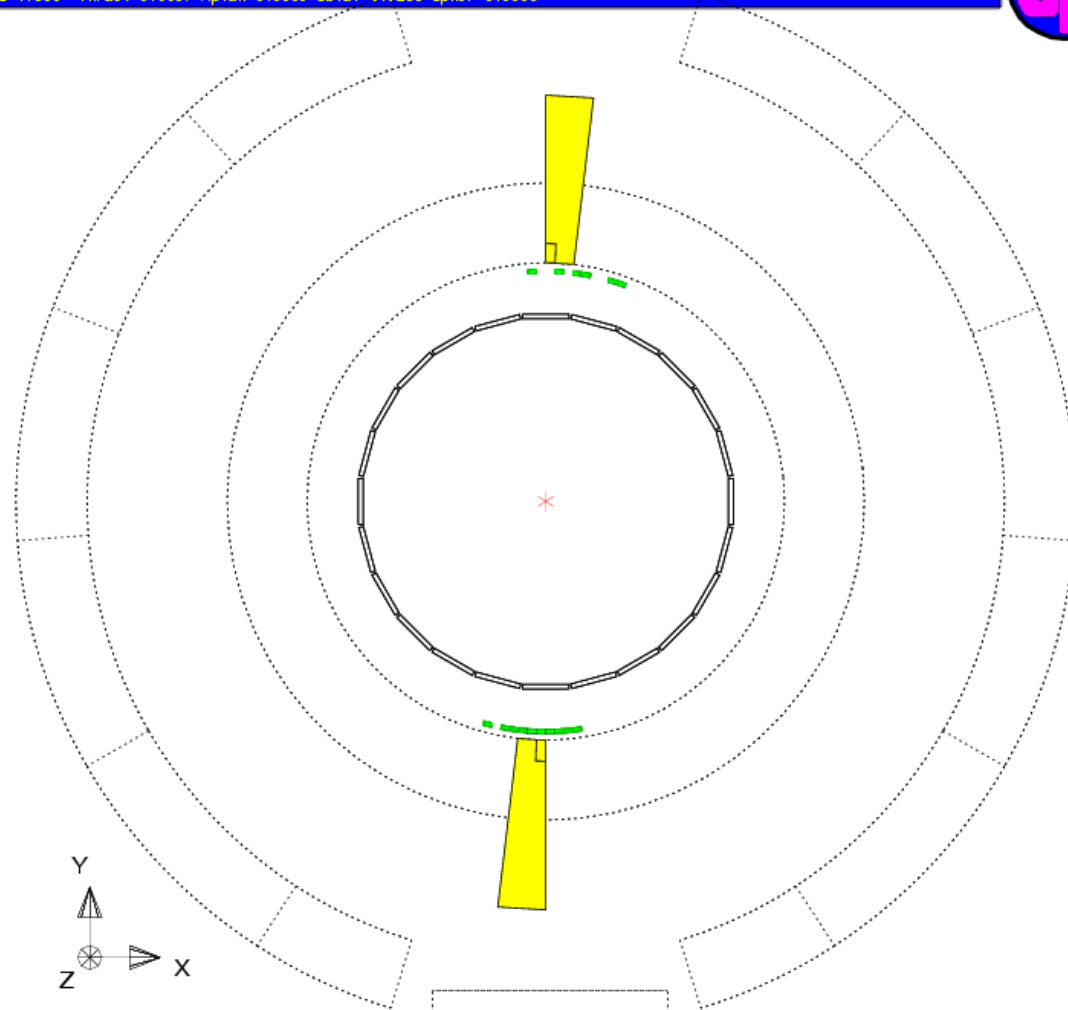

OPAL

$$e^+e^- \rightarrow \gamma\gamma$$

Centre of screen is (0.0000, 0.0000, 0.0000)

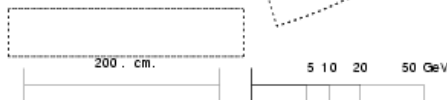

Ez milyen LEP-esemény?

Run: event 2468: 66487 Date 910819 Time 91037 Clrk(N= 0 Sump= 0.0) Ecal(N= 4 SumE= 15.3) Hcal(N= 0 SumE= 0.0)
Ebeam 45.613 Evis 15.3 Emiss 75.9 Vtx (-0.12, 0.12, 0.19) Muon(N= 0) Sec Vtx(N= 0) Fdet(N= 0 SumE= 0.0)
Bz=4.350 Thrust=0.9993 Aplan=0.0000 Oblat=0.0049 Spher=0.0000

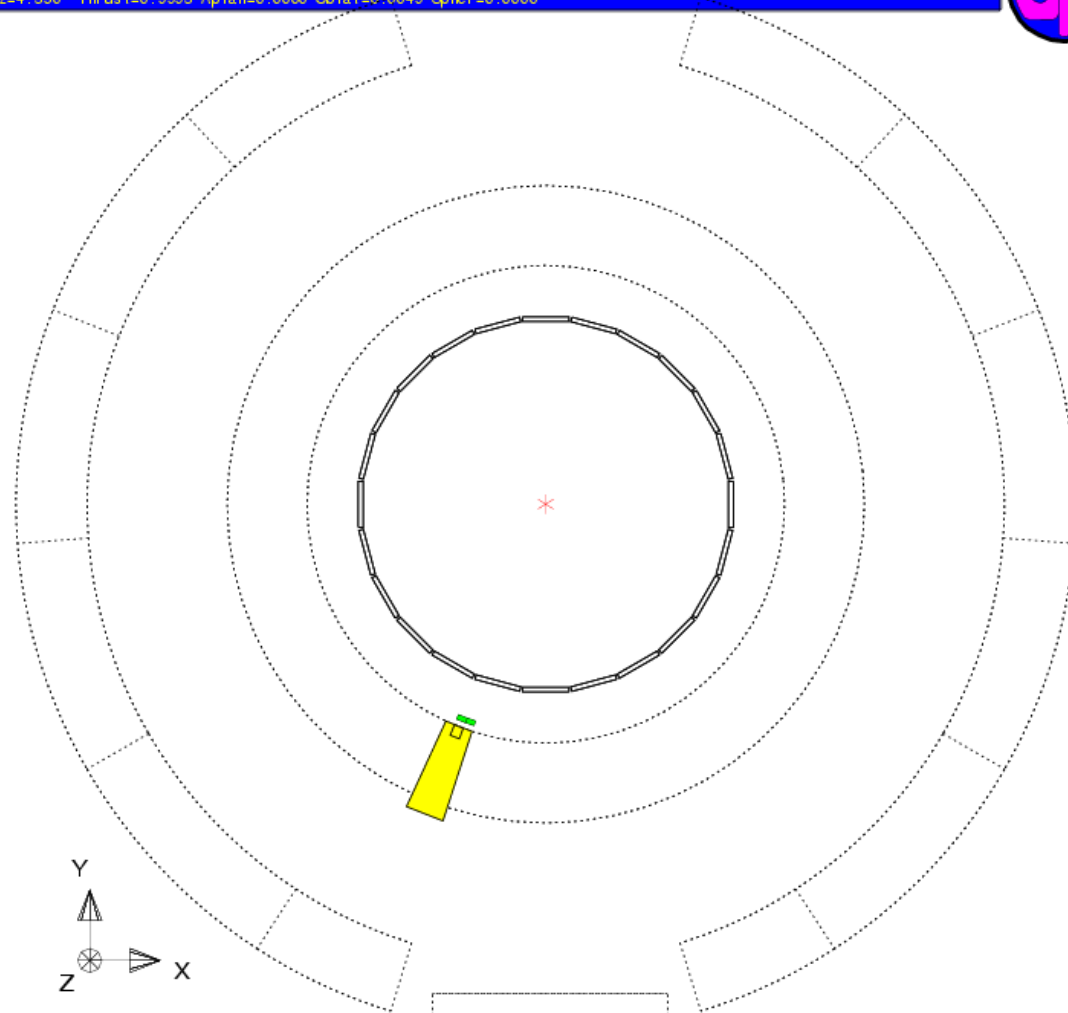

Centre of screen is (0.0000, 0.0000, 0.0000)

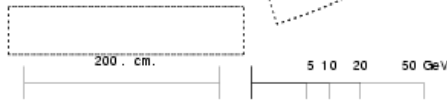

Ez milyen LEP-esemény?

Run: event 2468: 66487 Date 910819 Time 91037 Clrk(N= 0 Sump= 0.0) Ecal(N= 4 SumE= 15.3) Hcal(N= 0 SumE= 0.0)
Ebeam 45.613 Evis 15.3 Emiss 75.9 Vtx (-0.12, 0.12, 0.19) Muon(N= 0) Sec Vtx(N= 0) Fdet(N= 0 SumE= 0.0)
Bz=4.350 Thrust=0.9993 Aplan=0.0000 Oblat=0.0049 Spher=0.0000

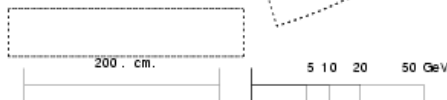
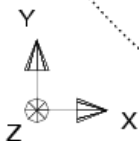
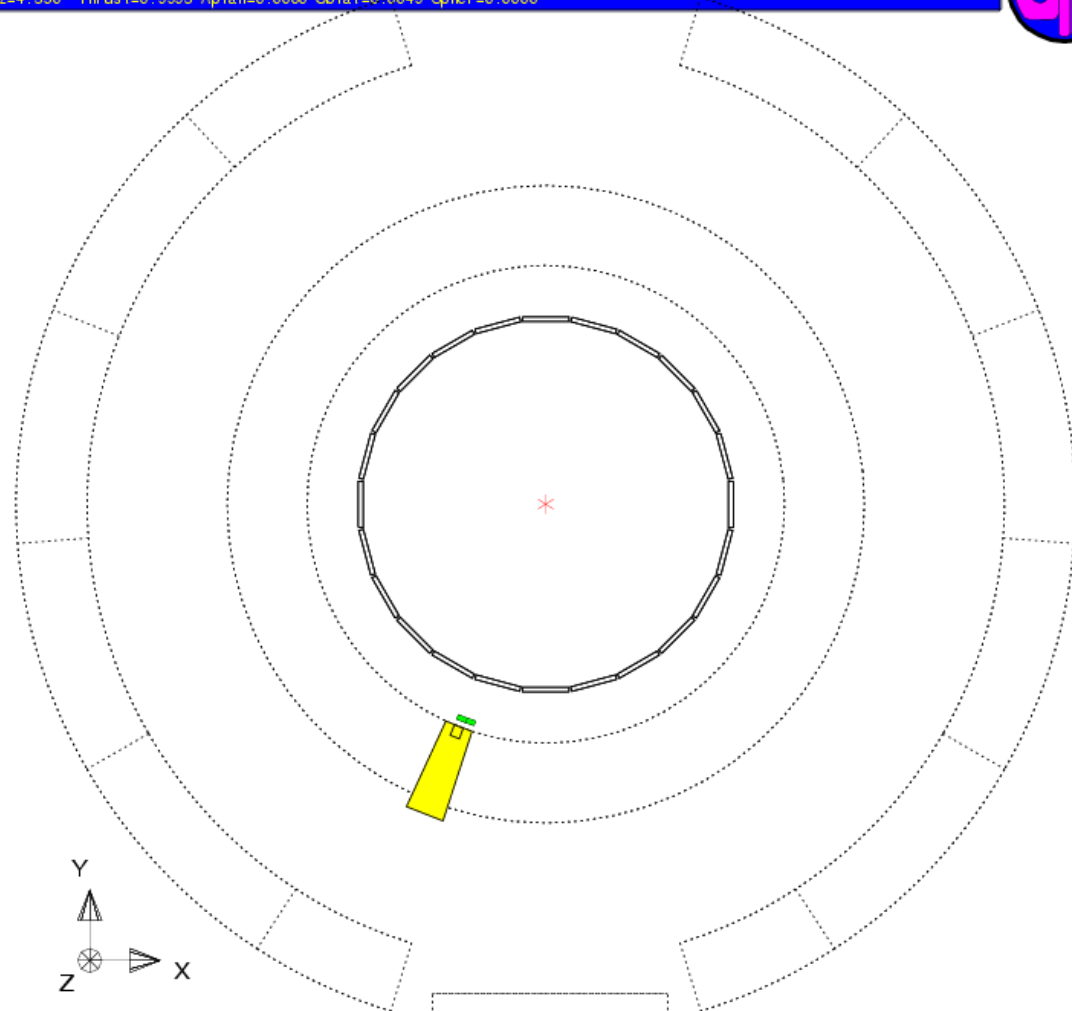

Centre of screen is (0.0000, 0.0000, 0.0000)

OPAL

$$e^+e^- \rightarrow \nu\nu\gamma$$

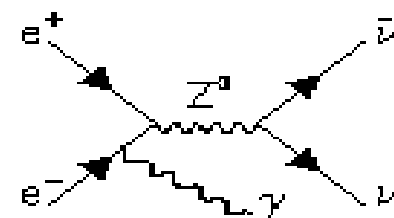

Ez milyen LEP-esemény?

Run: event 2542: 63750 Date 911014 Time 35925 Ctrk(N= 28 Sump= 42.1) Ecal(N= 42 SumE= 59.8) Hcal(N= 8 SumE= 12.7)
Ebeam 45.609 Evis 86.2 Emiss 5.0 Vtx (-0.05, 0.12, -0.90) Muon(N= 1) Sec Vtx(N= 0) Fdet(N= 2 SumE= 0.0)
Bz=4.350 Thrust=0.8223 Aplan=0.0120 Oblat=0.3338 Spher=0.2463

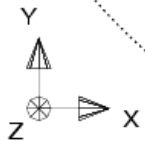
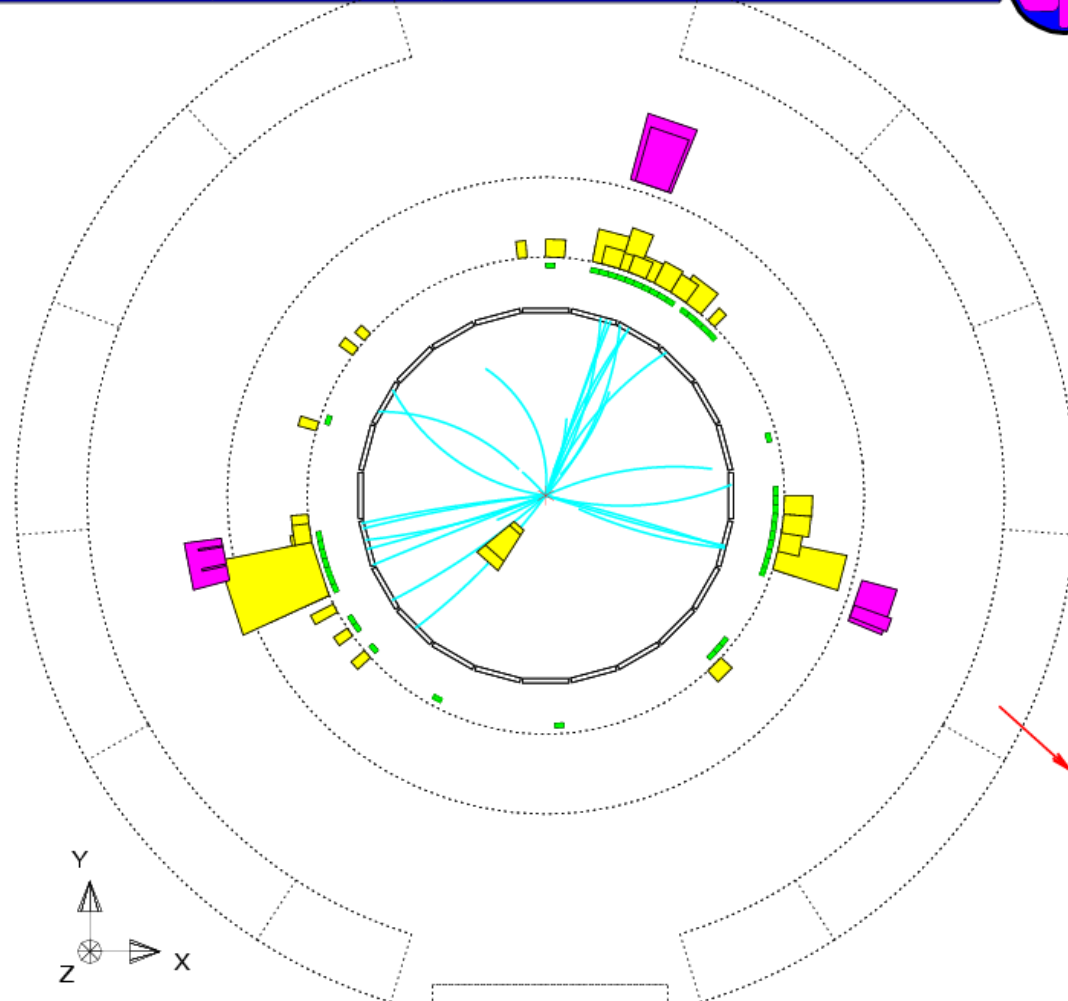

Centre of screen is (0.0000, 0.0000, 0.0000)

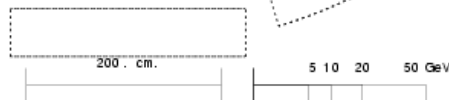

Ez milyen LEP-esemény?

Run: event 2542: 63750 Date 911014 Time 35925 Ctrk(N= 28 Sump= 42.1) Ecal(N= 42 SumE= 59.8) Hcal(N= 8 SumE= 12.7)
 Ebeam 45.609 Evis 86.2 Emiss 5.0 Vtx (-0.05, 0.12, -0.90) Muon(N= 1) Sec Vtx(N= 0) Fdet(N= 2 SumE= 0.0)
 Bz=4.350 Thrust=0.8223 Aplan=0.0120 Oblat=0.3338 Spher=0.2463

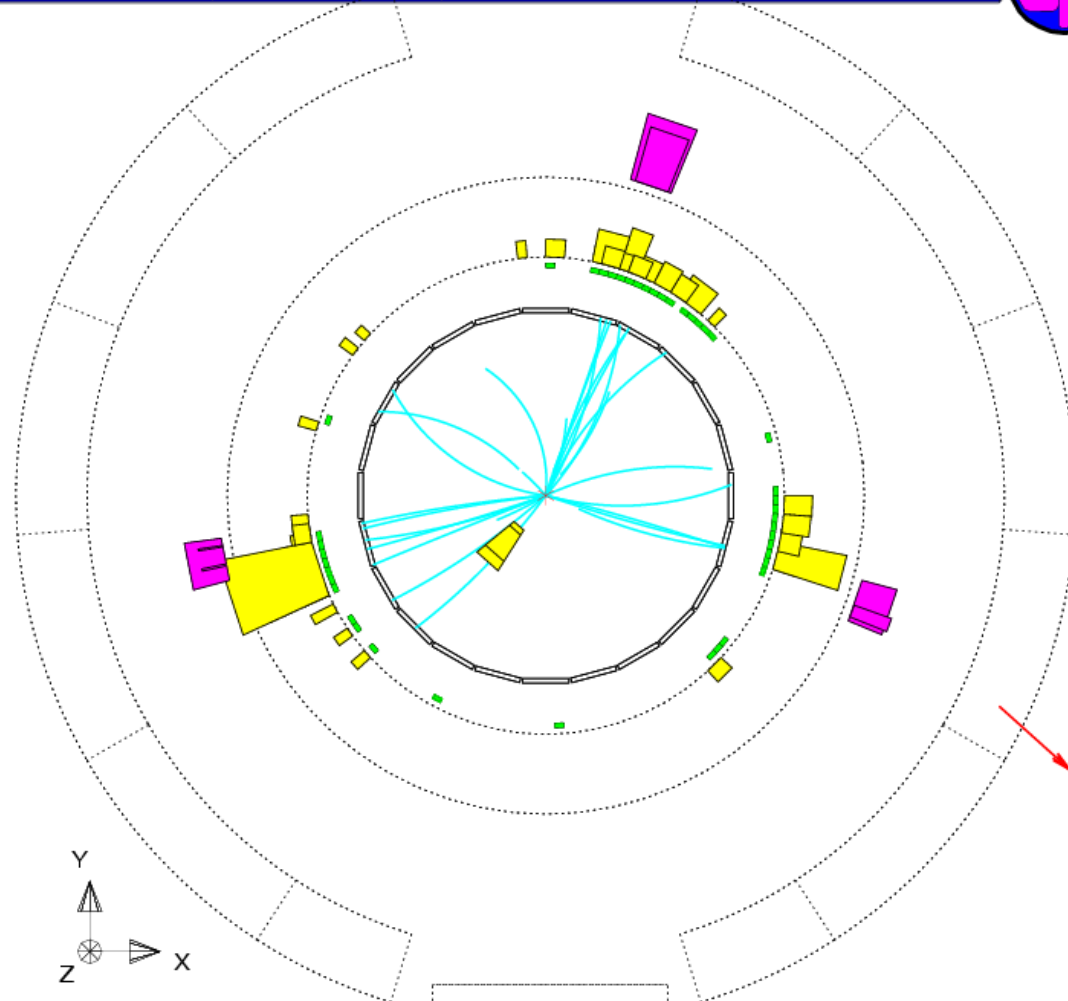

OPAL

$$e^+e^- \rightarrow q\bar{q}g$$

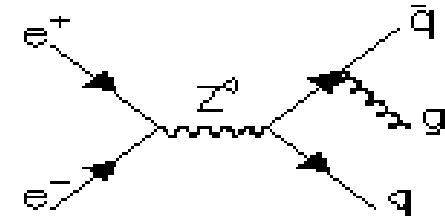

Centre of screen is (0.0000, 0.0000, 0.0000)



A Z-csúcs ($e^+e^- \rightarrow Z \rightarrow \dots$)

Rezonancia: $E_{CM}^2 = M_Z^2$



$$M_Z = 91.1875 \pm 0.0021 \text{ GeV}$$

Bomlási szélesség:

$$\Gamma_Z = \Gamma_{e^+e^-} + \Gamma_{\mu^+\mu^-} + \Gamma_{\tau^+\tau^-} + \Gamma_{\text{had}} + \Gamma_{\text{inv}}$$

SM mindegyiket megjósolja

Illesztés LEP-adatokhoz \Rightarrow

$M_Z, \Gamma_Z, \Gamma(Z \rightarrow \dots)$ vs. E_{CM}

A láthatatlan szélesség:

$$\begin{aligned} \Gamma_{\text{inv}} / \Gamma_Z &= \\ 1 - \Gamma_{\text{hadr}} / \Gamma_Z - 3 \times \Gamma_{\ell^+\ell^-} / \Gamma_Z &= \\ &= (20,0 \pm 0.6)\% \end{aligned}$$

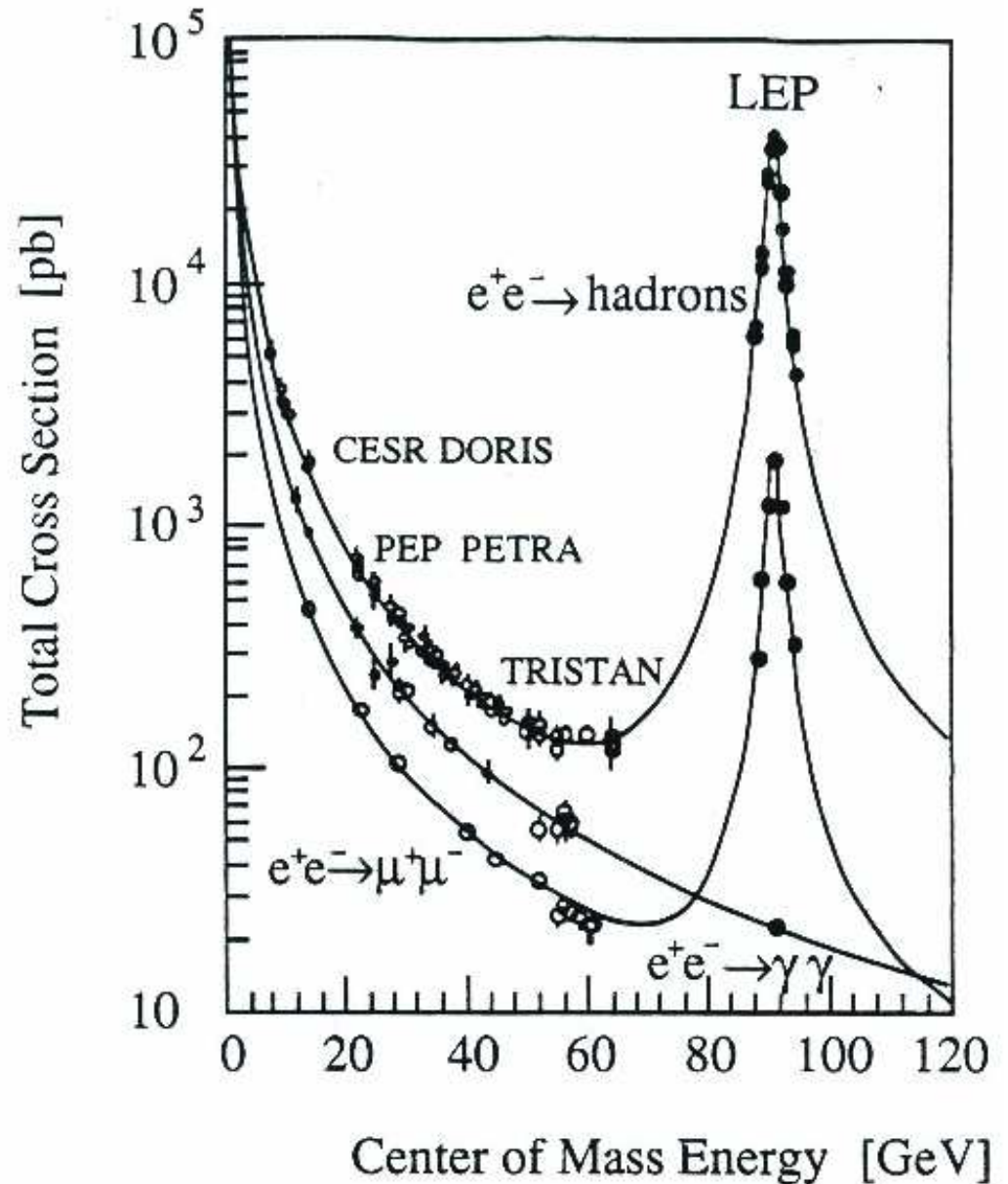

A 3 fermioncsalád

A láthatatlan szélesség:

$$\Gamma_{\text{inv}}/\Gamma_Z = (20,0 \pm 0,06)\%$$

Standard Modell: neutrínók

$$\Gamma_{\nu\bar{\nu}} = 1,979 \Gamma_{\ell+\ell^-}$$

$$\text{LEP: } \Gamma_{\nu\bar{\nu}}/\Gamma_Z = (3,3658 \pm 0,0023)\%$$

Könnyű neutrínók száma:

$$N_\nu = \Gamma_{\text{inv}}/\Gamma_{\nu\bar{\nu}} = 2,92 \pm 0,06$$

$\sigma(Z \rightarrow \text{hadrons})$

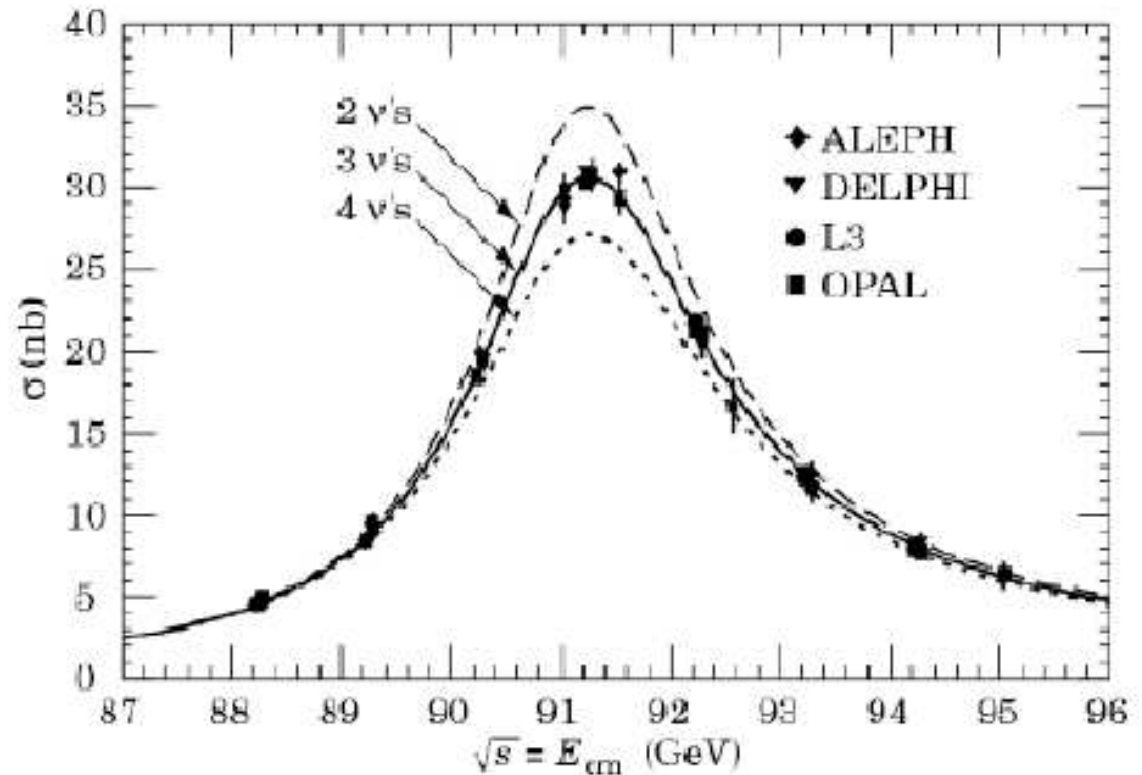

SM-ben 3 leptoncsalád \Rightarrow 3 kvarkcsalád (össztöltés 0!)



A SM Higgs–bozonja

Spin nélküli, semleges, nehéz részecske
kvantumszámok nélkül

A SM megadja a keletkezési és bomlási valószínűségeit.

Tömegfüggő, pl. fermion–párra bomlásé

$$\sigma(H \rightarrow f\bar{f}) \sim m_f^2 / m_W^2$$

A legnehezebb elérhető fermionokra bomlik

Tömeget a SM nem jósol, csak limitál:

$$30 \text{ GeV} < m_H < 500 \text{ GeV}$$

Megfigyelnünk nem sikerült. LEP: $m_H > 114.4 \text{ GeV}$

Létezik? SM: muszáj léteznie



A Standard Modell diadalmenete

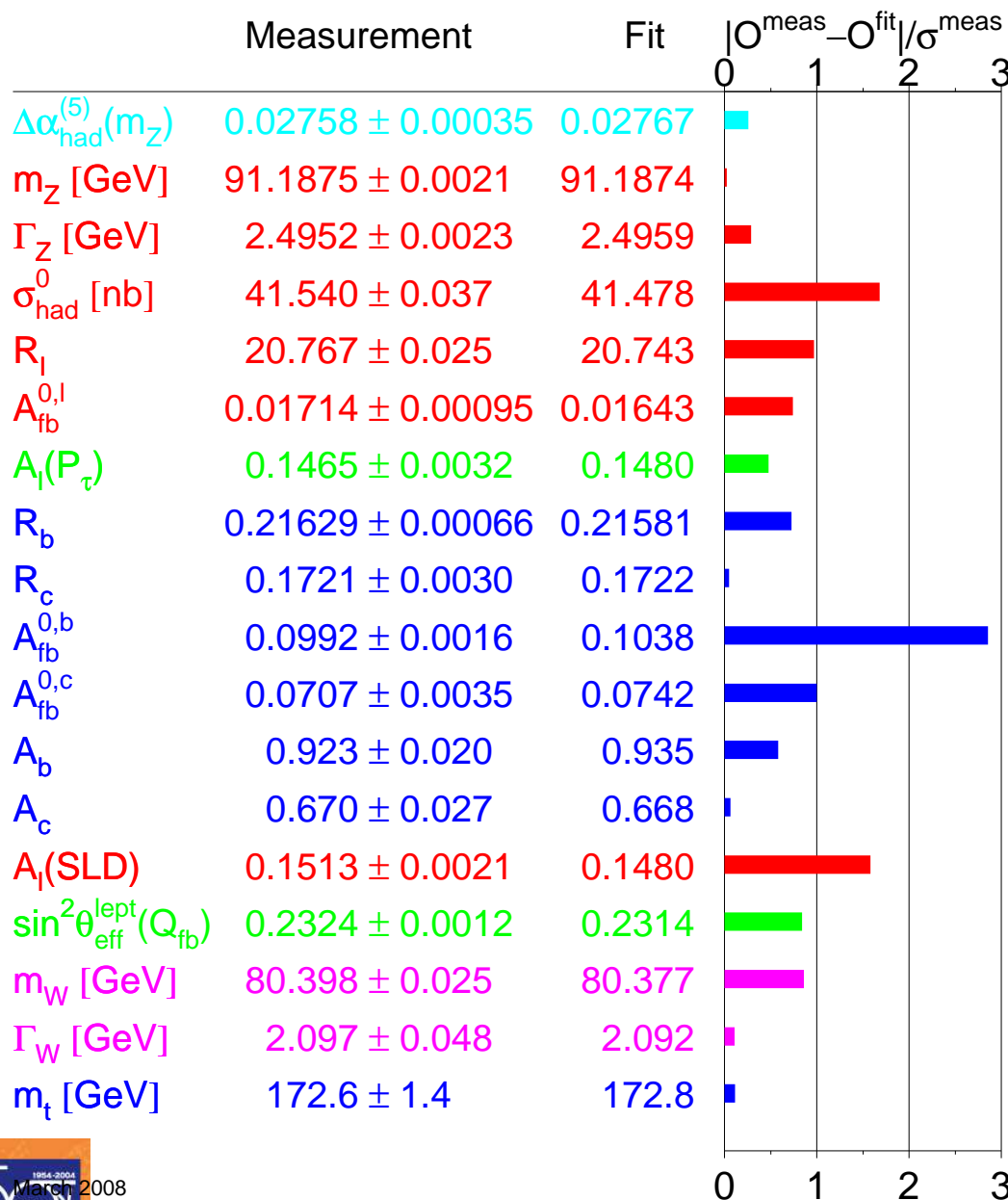

2008-as állapot

Valamennyi kísérlet
sokszáz mérésének
analízise:

$|Mért - számolt| / szórás$

Kilógó adat változik

Most a $e^+e^- \rightarrow Z \rightarrow b\bar{b}$
előre-hátra aszimmetriája

LEP Electroweuge munkacsoport:

<http://lepewwg.web.cern.ch/>



A SM érzékenysége Higgs-tömegre

Illesztés jósága Higgs-tömeg
függvényében

különböző elméleti becslésekre
(2009-es állapot)

Legjobb: $m_H \approx 90$ GeV

LEP: $114.4 \text{ GeV} < M_H$ (sárga)

Tevatron: $M_H \neq 160 - 170 \text{ GeV}$

Illesztés: $M_H < 160 \text{ GeV}$
(95 % konfidencia)

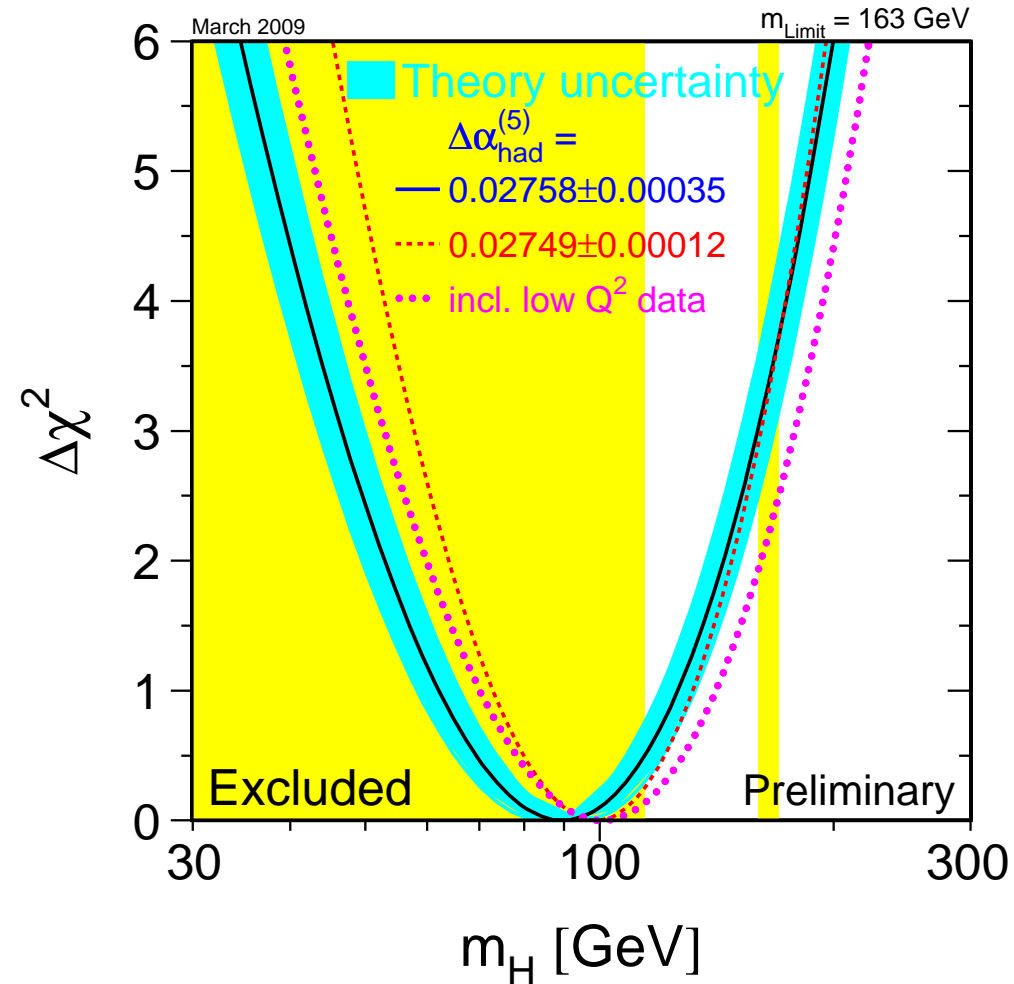

Ha mégsem létezik, a SM összeomlik, dacára a kiváló kísérleti
egyezésnek



LHC: A p–p ütközések bonyolultak!

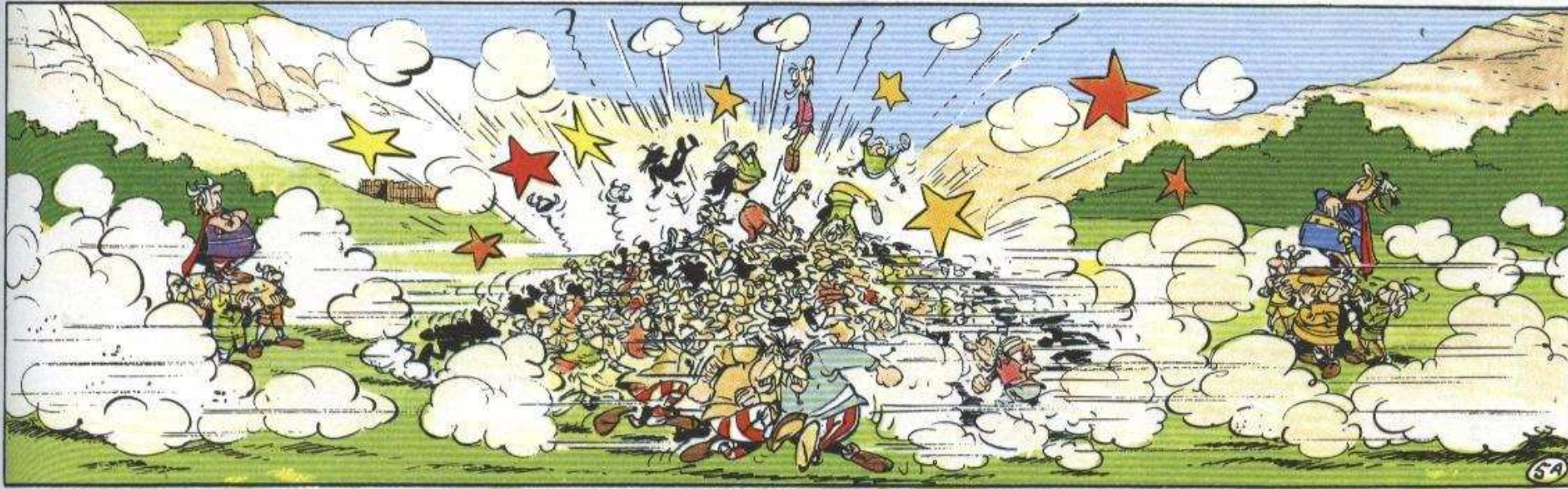

A relativisztikus proton impulzusának
felét kvarkok, másik felét gluonok adják

p-p ütközés = kiterjedt, összetett objektumoké

$e^+ - e^- \Leftrightarrow p - p \sim$ acélgolyó \Leftrightarrow túrógombóc

A Higgs-bomlás csatornáit

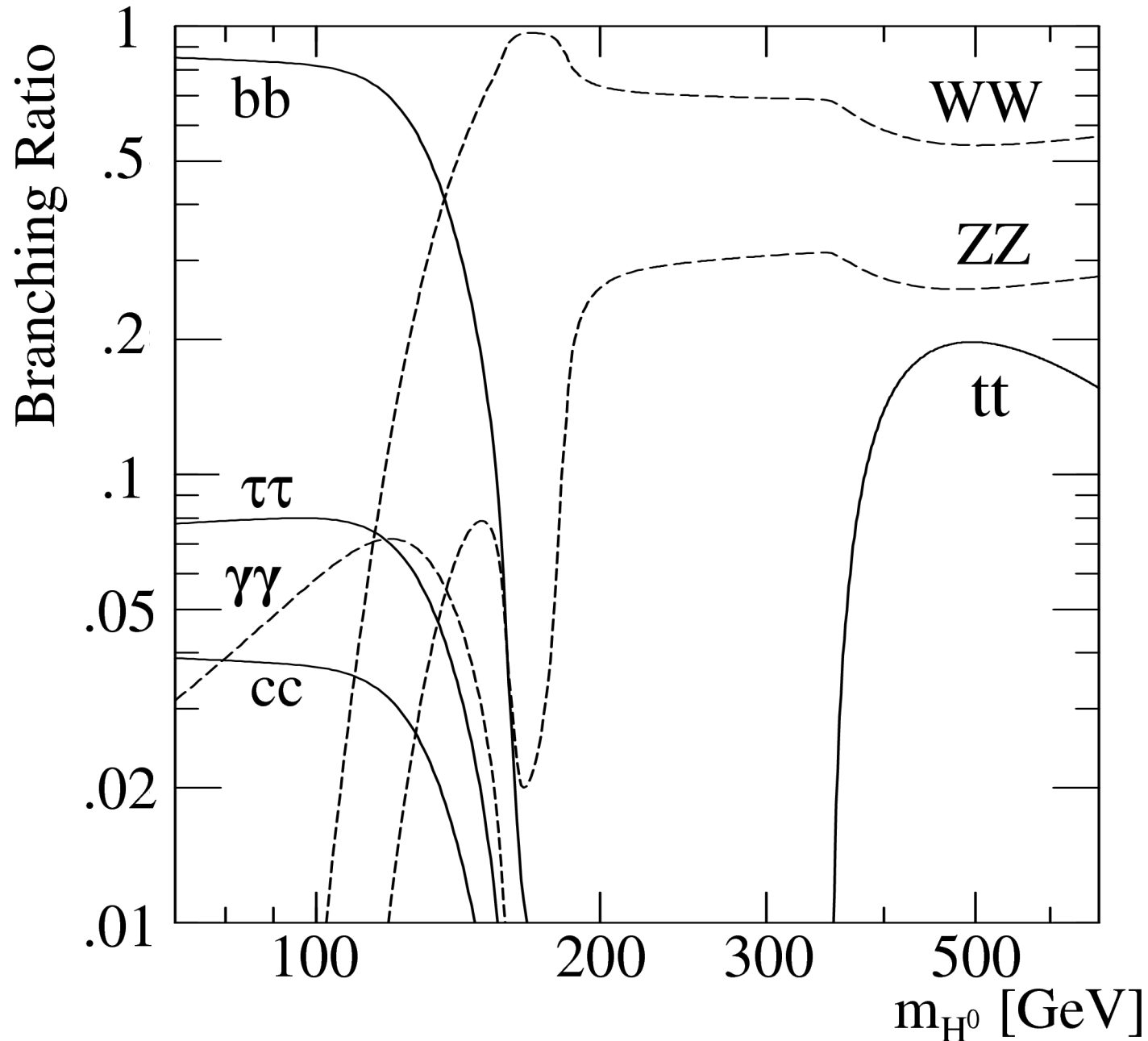

Az LHC CMS–detektora

CMS A Compact Solenoidal Detector for LHC

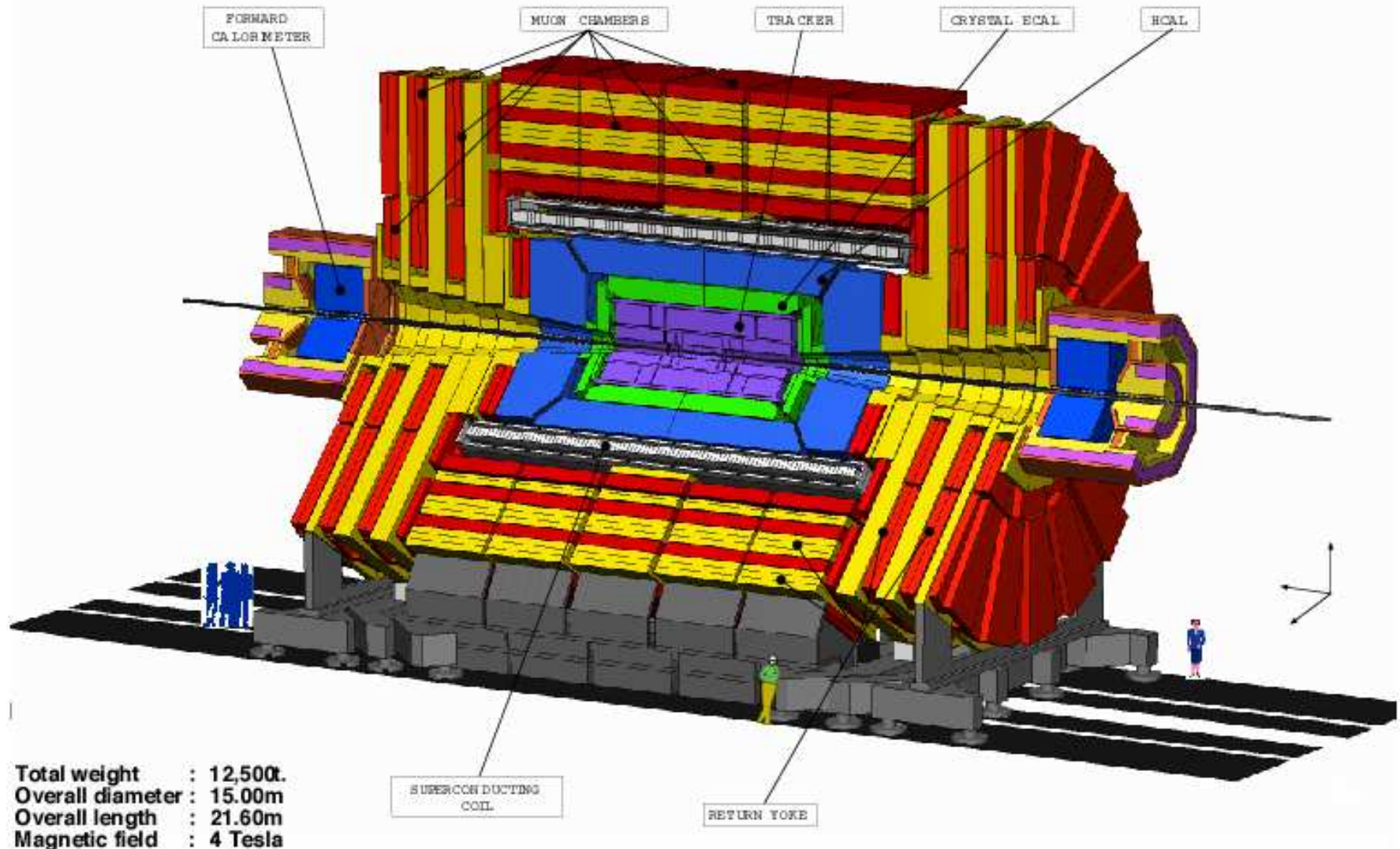

Az LHC CMS–detektora

(Compact Muon Solenoid)

Súly: 12500 tonna, több vas, mint Eiffel–toronyban

> 2000 résztvevő a világ minden tájáról

A világ legnagyobb (szupravezető) szolenoidja:
belső átmérő ~ 6 m, $B = 4$ Tesla

Detektorépítésben magyar részvétel:

Müondetektor pozicionáló rendszere: DE Kisérleti Fizika
Tanszék és ATOMKI

Very Forward Calorimeter: RMKI

Eseménytárolás: ≈ 10 PB/év adat, 10 PB/év MC

Adatkezelés: LHC Computing Grid

RMKI (BUDAPEST): 200 CPU, 40 TB HD

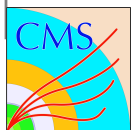

D. Szimmetriák és sértésük

- Tükrözési szimmetriák
- A paritássértés felfedezése
- Kaonfizika és CP-sértés
- CPT-invariancia és ellenőrzése

Tükrözési szimmetriák

Töltéstükrözés: $C\rho(r, t) = \bar{\rho}(r, t)$

Tértükrözés: $P\rho(r, t) = \rho(-r, t)$

Időtükrözés: $T\rho(r, t) = \rho(r, -t)$

Mindhárom szimmetria triviális ...

C töltés: elektromágneses és erős kölcsönhatás invariáns

P paritás: erős és e-m kh.: megőrzi

T időtükrözés: miért bántana?

Gyenge kölcsönhatás???

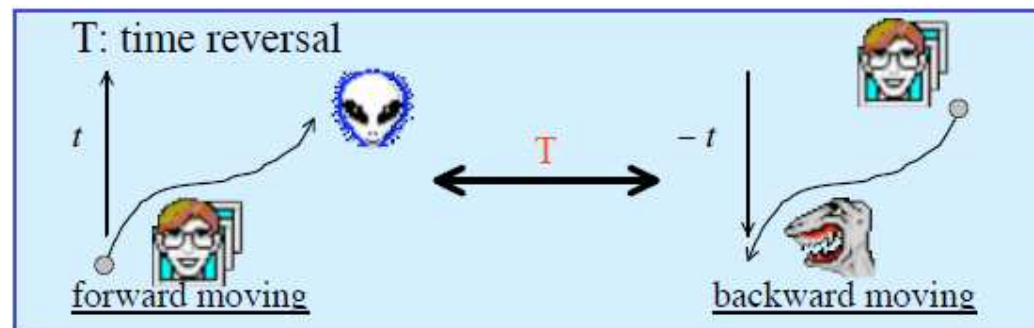
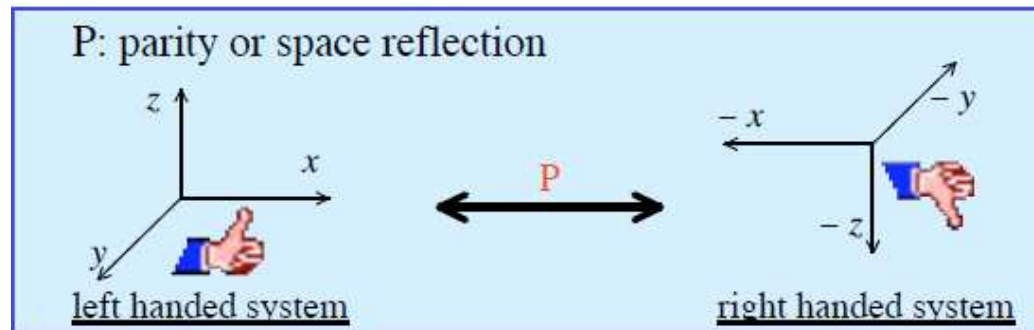
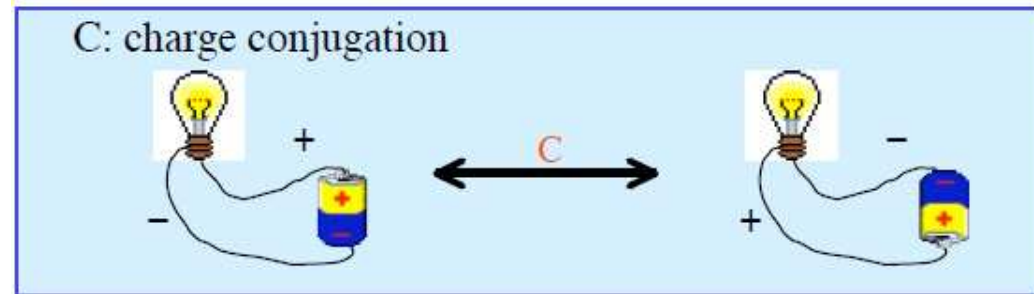

T. Nakada, CERN



Paritás

Bármely $f(x) = \text{páros} + \text{páratlan}$

$$f(x) = \frac{1}{2}[f(x) + f(-x)] + \frac{1}{2}[f(x) - f(-x)]$$

vagy

sorfejtésből páros x^{2k} és páratlan x^{2k+1} tagok

Állapotfüggvény páros vagy páratlan

Kölcsönhatások általában nem bántják



Térbeli tükrözés: paritás

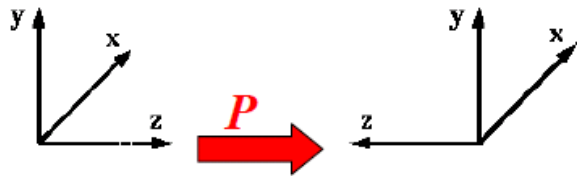
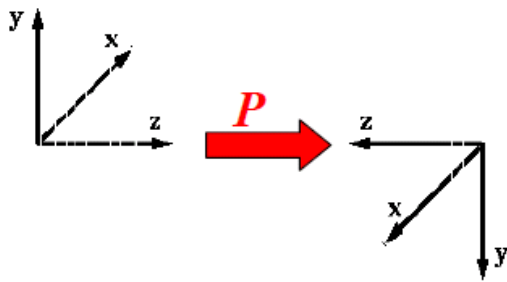

Koordinátarendszer

valamennyi tengelyének tükrözése:

jobbkezes \Rightarrow balkezes
rendszer

paritás előjelet vált

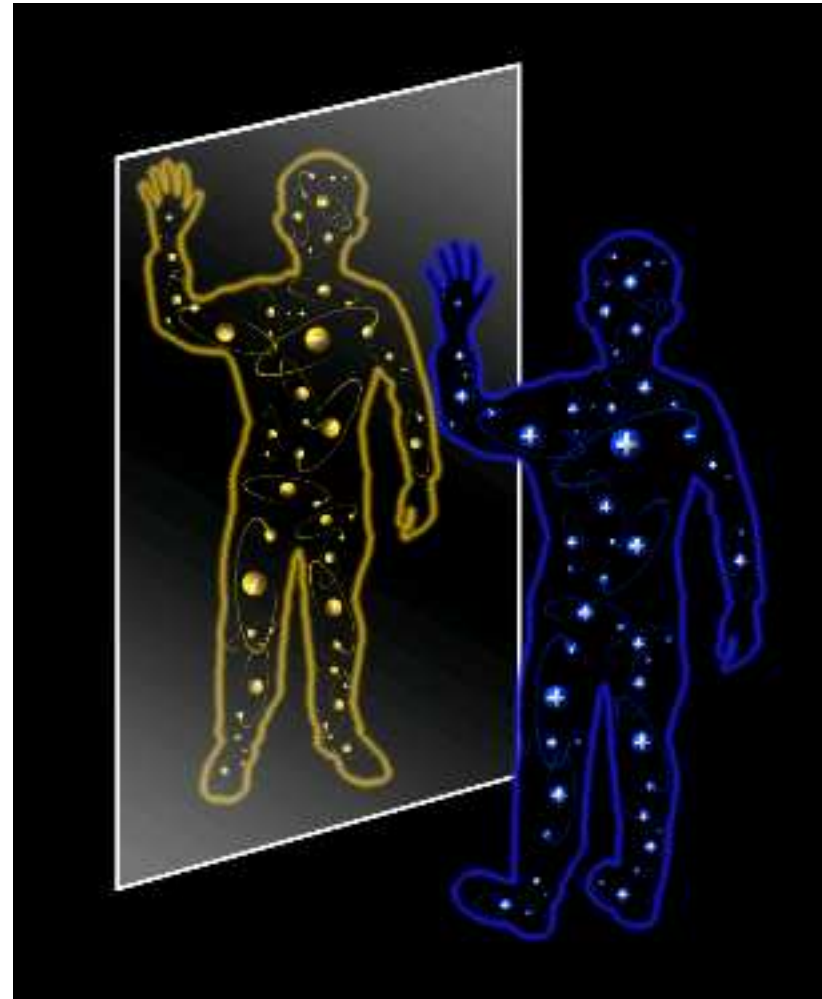

D. Kirkby, APS, 2003

Paritássértés β -bomlásban

A $\tau - \theta$ paradoxon:

Két részecske azonos tulajdonságokkal, csak a paritásuk különböző: $\tau^+ \rightarrow 2\pi \Leftrightarrow \theta^+ \rightarrow 3\pi$ ($J^P(\pi) = 1^-$)

Tsung-Dao Lee és Chen-Ning Yang:

Question of Parity Conservation in Weak Interactions

Phys. Rev. 104 (1956) 254-258. (50-éves évforduló 2006-ban)

- Paritásmegmaradás kísérleti bizonyítékai mind elektromágneses jelenségekre
- Gyenge kh. sérti paritást? $\tau^+ \equiv \theta^+ (\equiv K^+)$
- Javaslatok kísérleti ellenőrzésre

Kísérleti igazolás:

Chien-Shiung Wu *et al.* (és Richard L. Garwin *et al.*), 1957

Nobel-díj: Lee és Yang, 1957

(Hány cikk kell hozzá? Egy, ha elég jó...)



A Wu-kísérlet

C.S. Wu és társai: *Phys. Rev.* 105 (1957) 1413-1414

^{60}Co bomlása mágneses térben ($T < 0,1 \text{ K}$)



$$J = 5 \Rightarrow J = 4 + \frac{1}{2} + \frac{1}{2}$$



Tükörszimmetria maximális sérülése



Maximális paritásértés



balra polarizált részecskék \Leftrightarrow jobbkezes antirészecskék

„Nem tudom elhinni, hogy Isten balkezes” (Wolfgang Pauli)

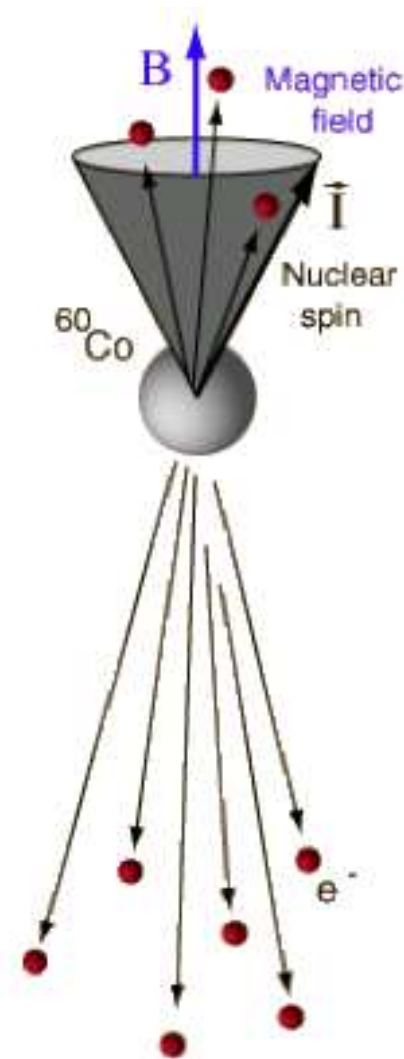

A Lederman-kísérlet

R.L. Garwin, L.M. Lederman, M. Weinrich: *Phys. Rev.* 105 (1957) 1415-1417

Pionbomlás:

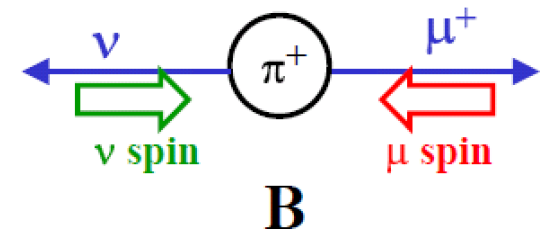
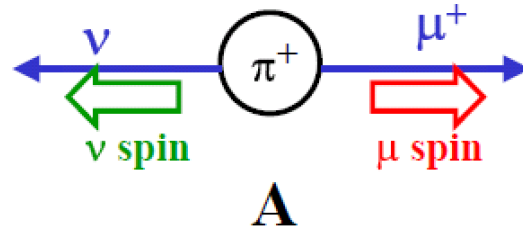

Csak B realizálódik \Rightarrow maximális paritássértés

Müonkeletkezés:



Müonbomlás:



μ SR-módszer: lokális B mérése
(szilárdtestfizika, kémia)

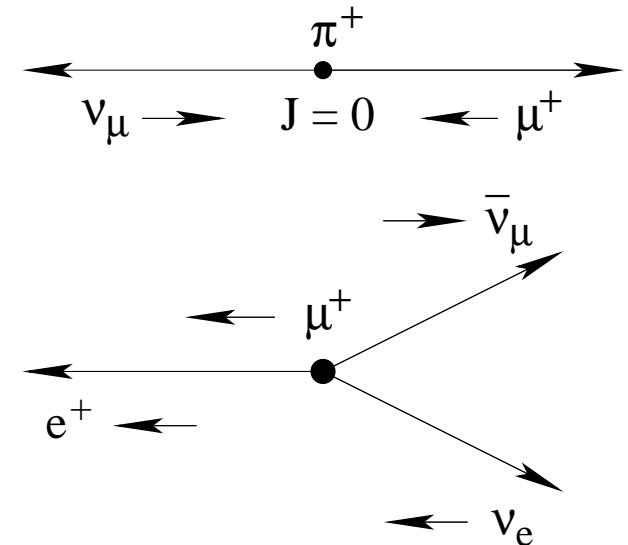

A paritásértés felfedezése: kísérlet

Experimental Test of Parity Conservation in Beta Decay*

C. S. WU, *Columbia University, New York, New York*

AND

E. AMBLER, R. W. HAYWARD, D. D. HOPPE, AND R. P. HUDSON,
National Bureau of Standards, Washington, D. C.

(Received January 15, 1957)

The inspiring discussions held with Professor T. D. Lee and Professor C. N. Yang by one of us (C. S. Wu) are gratefully acknowledged.

Phys. Rev. 105 (1957) 1413-1414

Observations of the Failure of Conservation of Parity and Charge Conjugation in Meson Decays: the Magnetic Moment of the Free Muon*

RICHARD L. GARWIN,† LEON M. LEDERMAN,
AND MARCEL WEINRICH

*Physics Department, Nevis Cyclotron Laboratories,
Columbia University, Irvington-on-Hudson,
New York, New York*

(Received January 15, 1957)

The authors wish to acknowledge the essential role of Professor Tsung-Dao Lee in clarifying for us the papers of Lee and Yang. We are also indebted to Professor C. S. Wu⁶ for reports of her preliminary results in the Columbia discussions immediately preceding this experiment.

Phys. Rev. 105 (1957) 1415-1417

A tudományos etika és kollegialitás gyönyörű példája:

Wu csoportja hónapokig dolgozott a kísérleten.

Garwinék 1 napot mértek, 1 hetet értékelték, aztán vártak Wu-ra



A CP-szimmetria és sértése

P és CP hatása

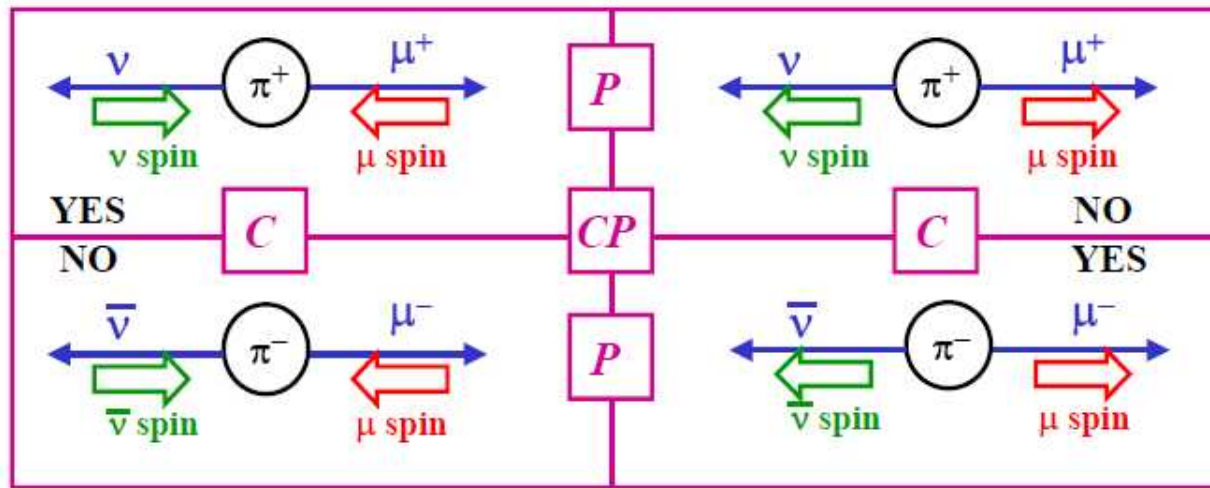

A CP-szimmetriában mindenki hitt, de a P-sértés felfedezése miatt ellenőrizni kellett

Christenson, Cronin, Fitch és Turlay, 1964:

CP-sértés K^0 bomlásában (kicsi: $\sim 2,3 \times 10^{-3}$)

Ezúttal kísérleti Nobel-díj: Cronin és Fitch, 1980

A CP-sértés vizsgálata azóta is a részecskefizika egyik fontos területe

CPT-invariancia

A térelmélet alaptétele:

$$CPT|p(r, t)\rangle \sim |\bar{p}(-r, -t)\rangle \sim |p(r, t)\rangle$$

azaz szabad antirészecske \sim részecske,
amely téridőben visszafelé mozog.

CPT sérülése sértené:

- a kölcsönhatások lokalitását azaz a kauzalitást, vagy
- unitaritást, az anyag, információ, ... megmaradását,
- vagy a Lorentz-invarianciát.

Elmélet általában: *CPT* nem sérül

De vannak *CPT*-sértő modellek \Rightarrow ellenőrizni



Részecske = – antirészecske ?

- $[m(K^0) - m(\bar{K}^0)]/m(\text{átlag}) < 10^{-18}$
- proton \sim antiproton? (m, q, μ összehasonlítása)
- hidrogén \sim antihidrogén? ($2S - 1S$)

Kétfotonos
spektroszkópia



keskeny vonal

ellentétes irányú

lézerek



Doppler-mentes

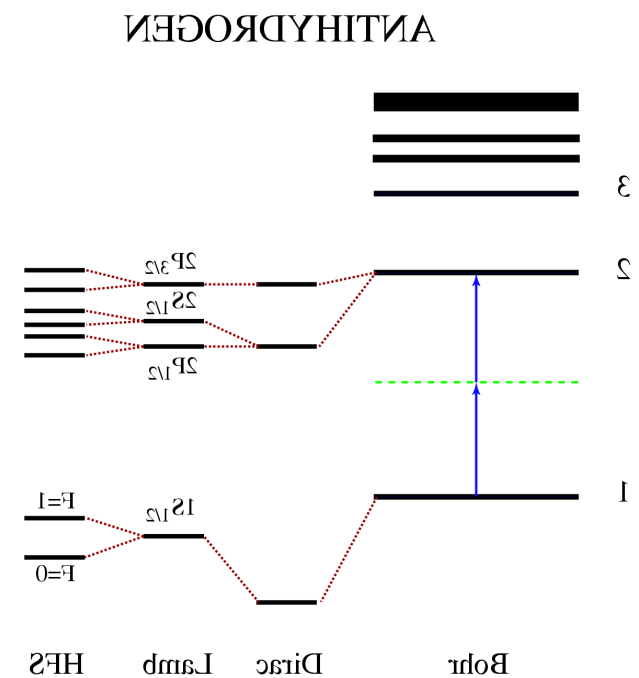
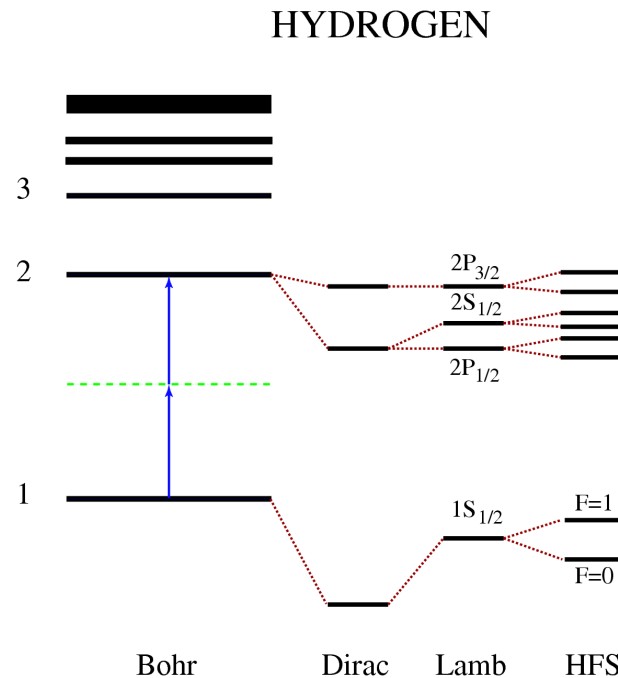

A CERN antiproton–lassítója (AD)

a *CPT*-invariancia ellenőrzésére épült

Három *CPT*-kísérlet az AD-nál:

ATRAP: $q(\bar{p})/m(\bar{p}) \leftrightarrow q(p)/m(p)$
 $\bar{H}(2S - 1S) \leftrightarrow H(2S - 1S)$

ALPHA: $\bar{H}(2S - 1S) \leftrightarrow H(2S - 1S)$

ASACUSA:

$$q(\bar{p})^2 m(\bar{p}) \leftrightarrow q(p)^2 m(p)$$

$$\mu_e(\bar{p}) \leftrightarrow \mu_e(p)$$

Vörös: működik, zöld: tervben



ASACUSA: Atomic Spectroscopy And Collisions Using Slow Antiprotons

Tokió, Aarhus, Bécs, Brescia, Budapest, Debrecen, München



5 magyar résztvevő



Az antiproton tömege és töltése

Protoné jól ismert:

$$m(p)/m(e) = 1836.15267261(85)$$

$$q(e) = 1.602176462(63) \text{ C}$$

$$\text{Pontosság: } 5 \cdot 10^{-10} \text{ és } 4 \cdot 10^{-8}$$

Relatív mérés: proton \Leftrightarrow antiproton

Ciklotron-frekvencia csapdában $\rightarrow q/m$

TRAP (LEAR) \Rightarrow ATRAP (AD)

Harvard, Jülich, München, Szöul

Atomi átmenetek energiája \bar{p} -atomban:

$$E_n \approx -m_{\text{red}} c^2 (Z\alpha)^2 / (2n^2) \rightarrow m \cdot q^2$$

PS-205 (LEAR) \Rightarrow ASACUSA (AD)

Felső határ CPT -sértésre: 2 ppb (2×10^{-9})

M. Hori, ... B. Juhász, D. Barna, D. Horváth:

Phys. Rev. Lett. 96 (2006) 243401.

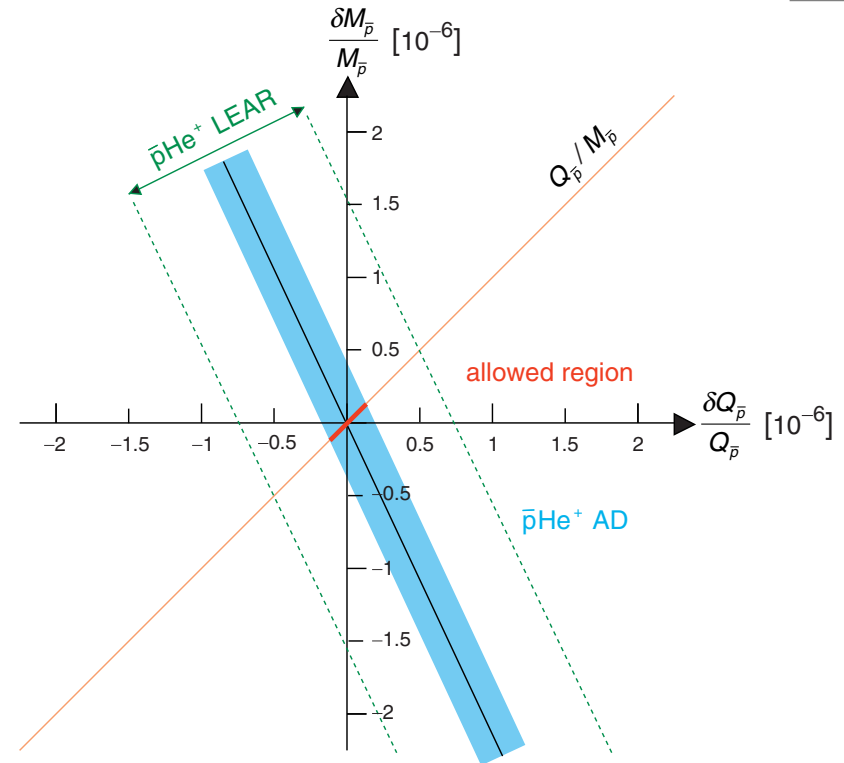

Tokió
Asakusa-
negyede
télen

