



# **An Introduction to the Geant4 toolkit & collaboration**

J. Apostolakis, CERN

for the Geant4 collaboration

# Overview



- ⌘ Simulation packages/toolkits
  - ☑ Key capabilities and concepts
- ⌘ What it can do - highlights
  - ⌘ Application areas
- ⌘ What is inside – lightning tour
  - ⌘ Brief highlights of capabilities
- ☑ Transparency of results
  - ☑ Open source
- ⌘ GEANT4: the collaboration

# What can a simulation package or toolkit do ?

⌘ A **Package** provides 'general' tools to undertake (some or all) of the key tasks:

- ☒ tracking, and geometrical propagation
- ☒ modelling of physics interactions,
- ☒ visualization, persistency

and enable you to describe your setup's

- ☒ detector geometry,
- ☒ radiation source,
- ☒ details of sensitive regions

# GEANT 4



- ⌘ Detector simulation **tool-kit** from HEP
  - ☑ full functionality: geometry, tracking, physics, I/O
  - ☑ offers alternatives, allows for tailoring
- ⌘ Software Engineering and OO technology
  - ☑ provide the architecture & methods for maintaining it
- ⌘ **Requirements** from:
  - ☑ current and future HEP experiments
  - ☑ medical and space science applications
- ⌘ **World-wide collaboration**

# Key Capabilities

- ⌘ **'Kernel'**: create, manage, move tracks
  - ☒ tracking, stacks, geometry, hits, ...
    - ☒ Extensible, flexible
- ⌘ **Physics Processes X-section, final-state**
  - ☒ models for electromagnetic, hadronic, ...
    - ☒ Can be 'assembled' for use in an application area
- ⌘ Tools for **faster** simulation
  - ☒ 'Cuts', ramework shower parameterisation
  - ☒ Event biasing, variance reduction.
- ⌘ Open **interfaces** for input/output
  - ☒ User commands, visualization, persistenc

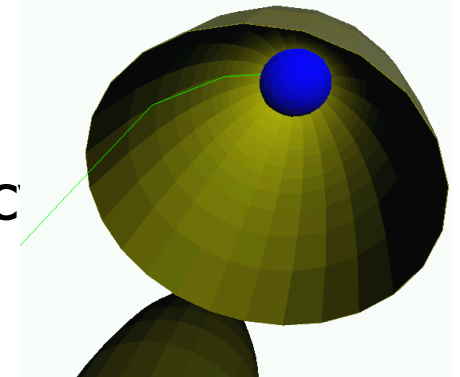

# Brief History

- ⌘ Geant4 started as RD44 project (1994-98)
  - ☑ Amongst first OO in HEP, 1<sup>st</sup> for simulation
  - ☑ Dec 1998: 1<sup>st</sup> supported release Geant4.0.0
- ⌘ First uses in production in several fields
  - ☑ Space: 1999 XMM (X-ray telescope)
  - ☑ HEP: 2001 BaBar, 2004 ATLAS/CMS/LHCb
- ⌘ Regular public releases (1-2 per year)
  - ☑ Geant4 release 9.0 (Jun 07), 9.3 (Dec 09)



# **APPLICATION AREAS**

# Application domains



## ⌘ High Energy Physics

- ☑ Collider Experiments

- ☑ Rare Event Experiments

## ⌘ Nuclear Physics Experiments

- ☑ Diverse small experiments

## ⌘ Medical Physics

## ⌘ Space: radiation environments, satellite science





# **HIGH ENERGY PHYSICS**

# High Energy Physics Uses

## ⌘ Collider Experiments

- ☒ BaBar has Geant4-based production simulation (since ca 2002)

- ☒ ATLAS, CMS, LHCb's detector simulation in production since early 2004

## ⌘ Rare Event Experiments

- ☒ Borexino, KAMland, ...

# BaBar

⌘ BaBar at SLAC was the pioneer experiment in HEP in use of Geant4

☑ Started in 2000

☑ Simulated several  $\times 10^{10}$  events

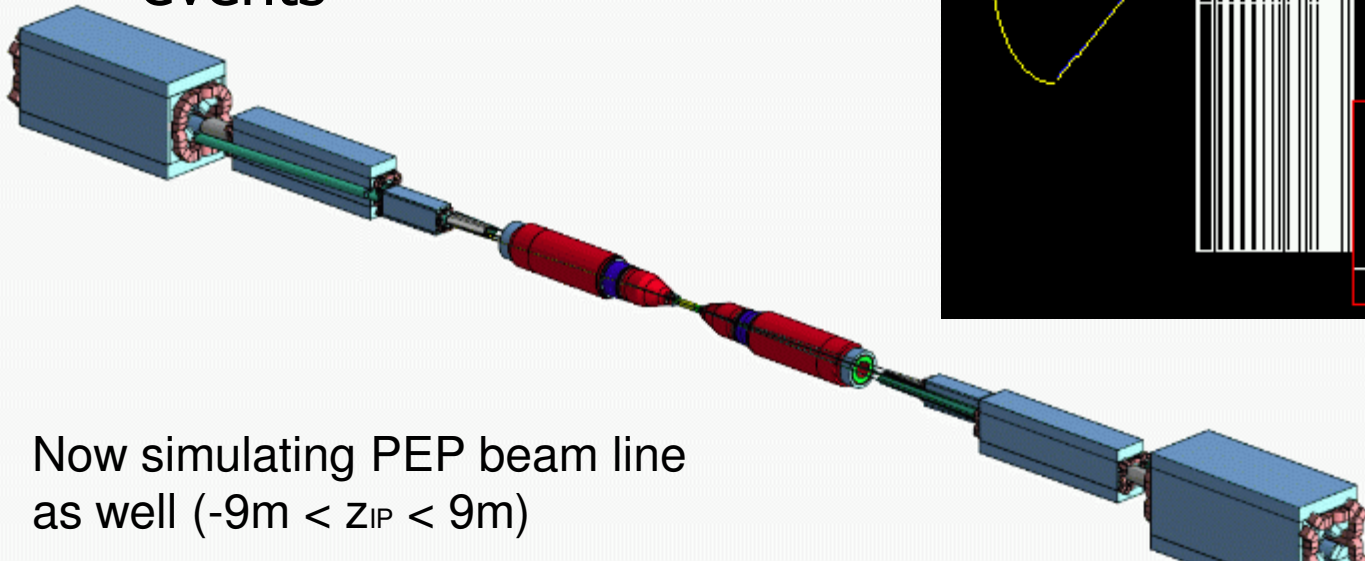

Now simulating PEP beam line as well ( $-9\text{m} < z_{\text{IP}} < 9\text{m}$ )

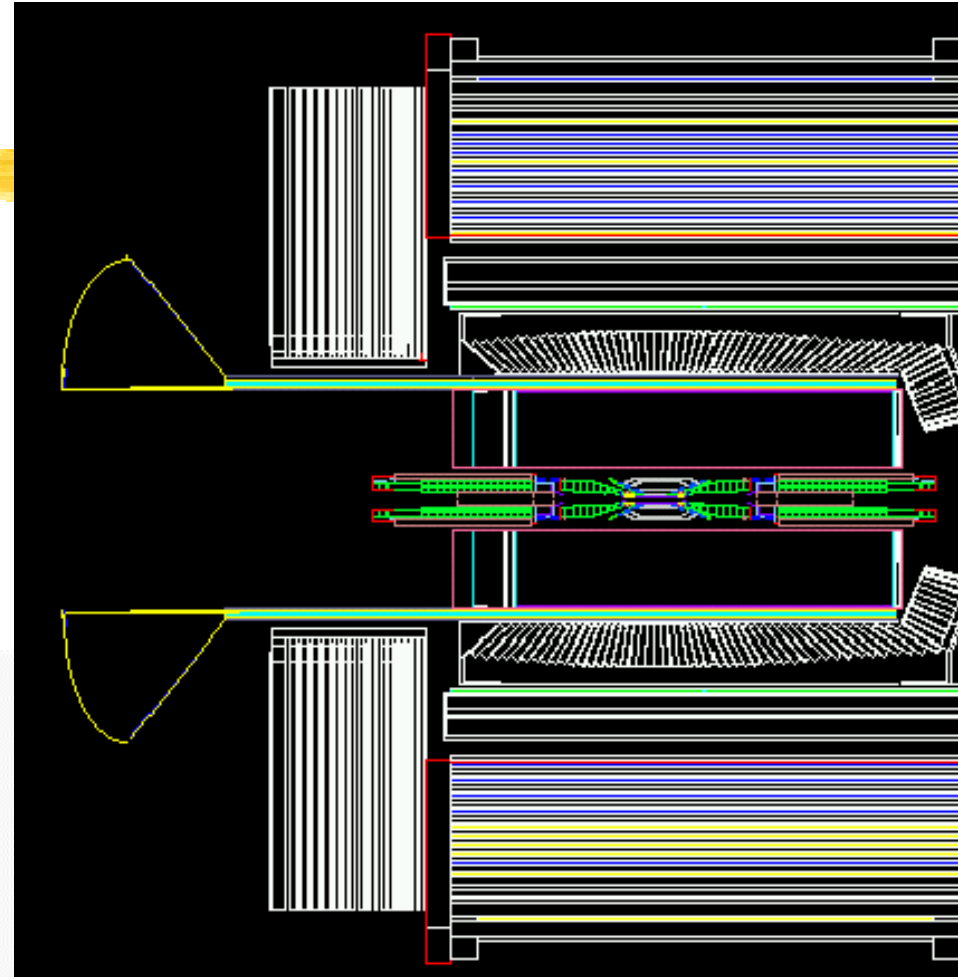

Courtesy of D.Wright (SLAC)

# Pion longitudinal shower profile in stand-alone ATLAS TileCal test-beam at 90°

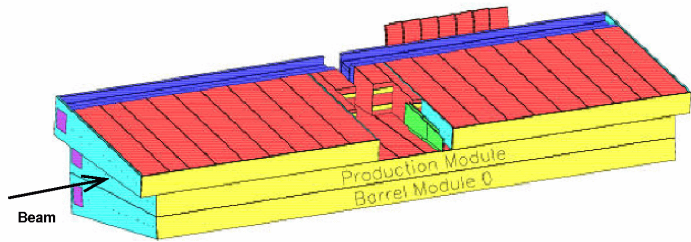

Thanks to Atlas Tilecal

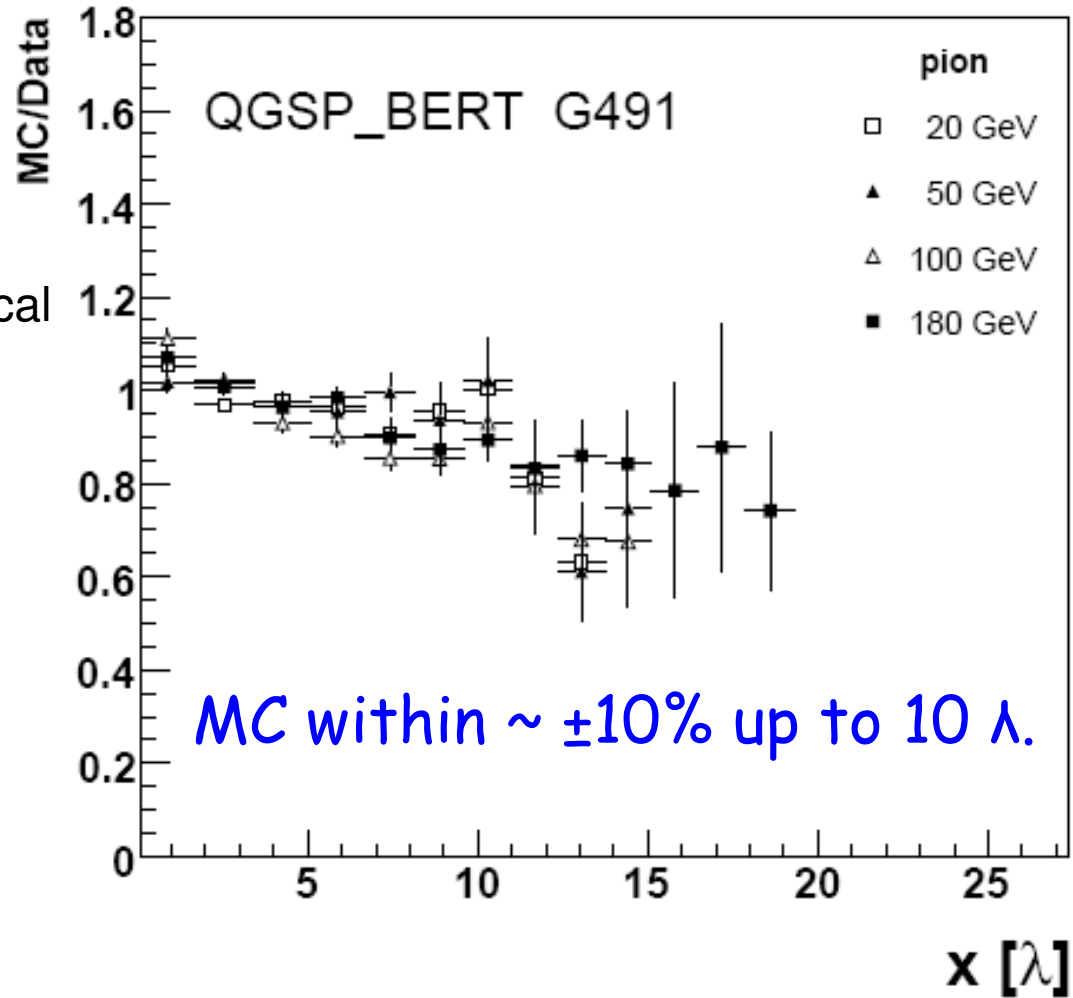
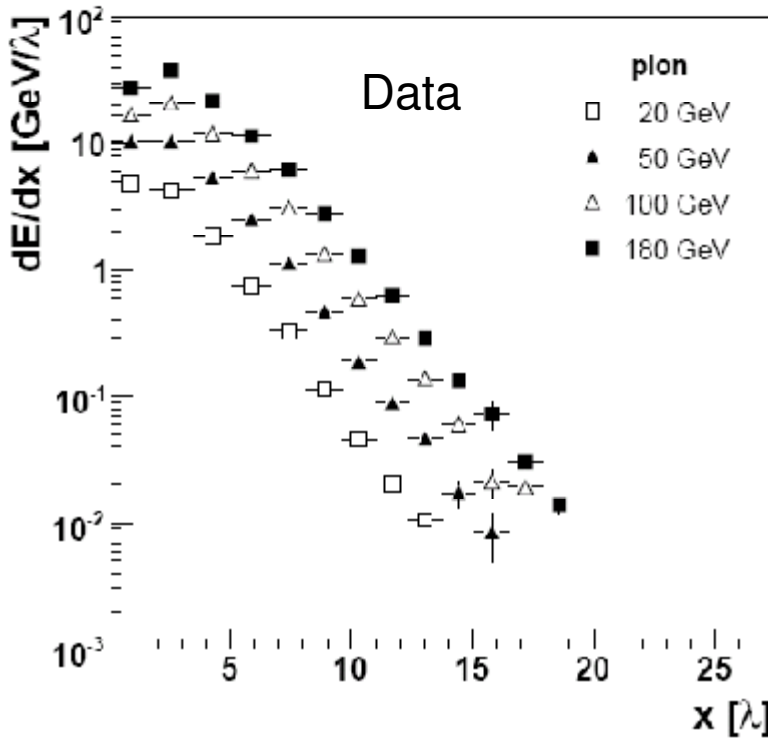

MC within  $\sim \pm 10\%$  up to  $10 \lambda$ .

For Protons :  $-(20\%-40\%)$  at  $10 \lambda$ .

# CMS Test Beam Efforts



CMS

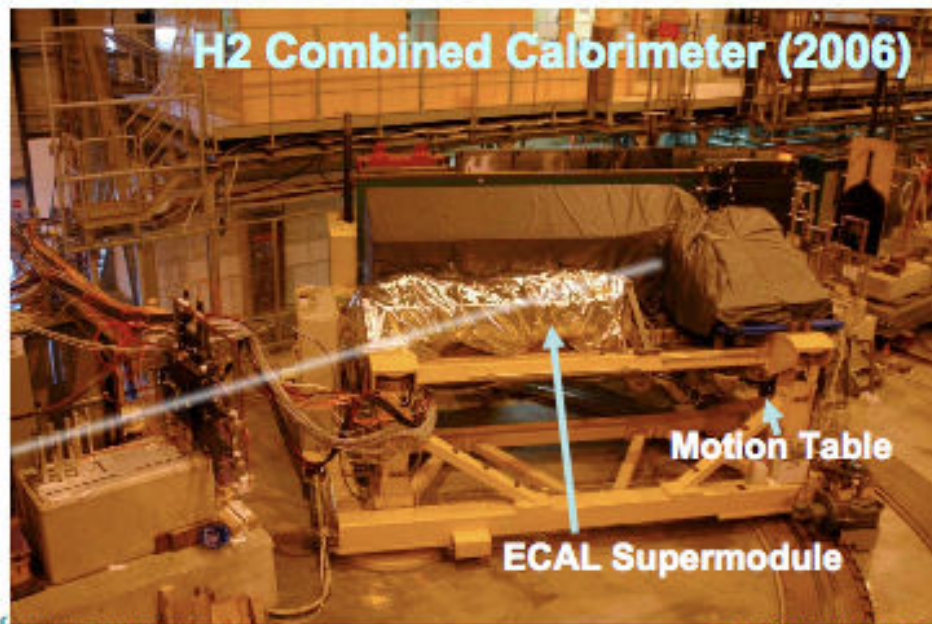
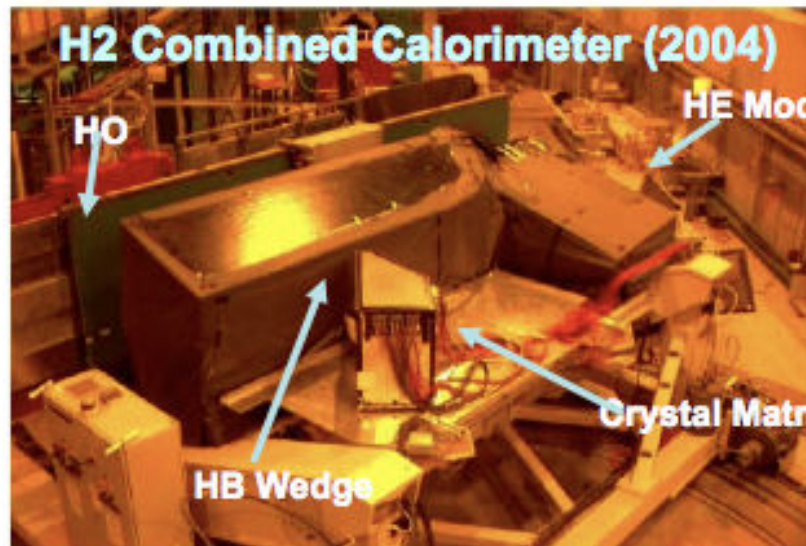
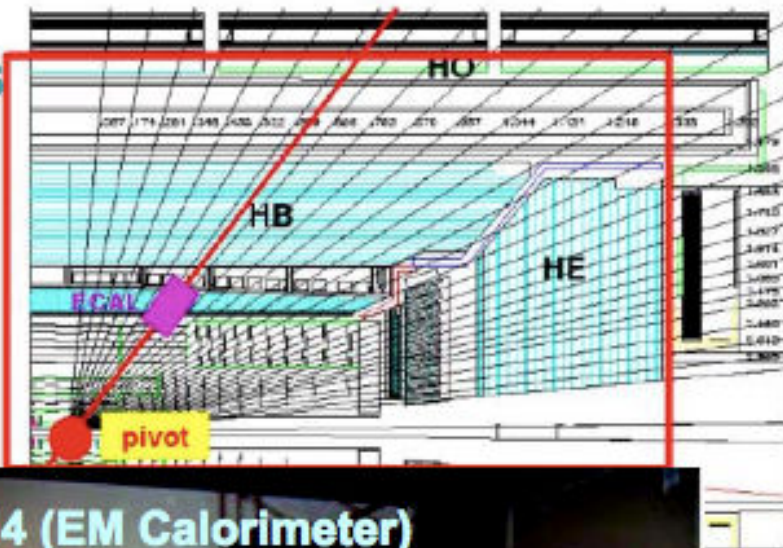

Oct

Courtesy: CMS

Simulation in CMS

S. Banerjee

Talk of S. Banerjee, Geant4 Workshop 2009

# Geant4 at the LHC Today

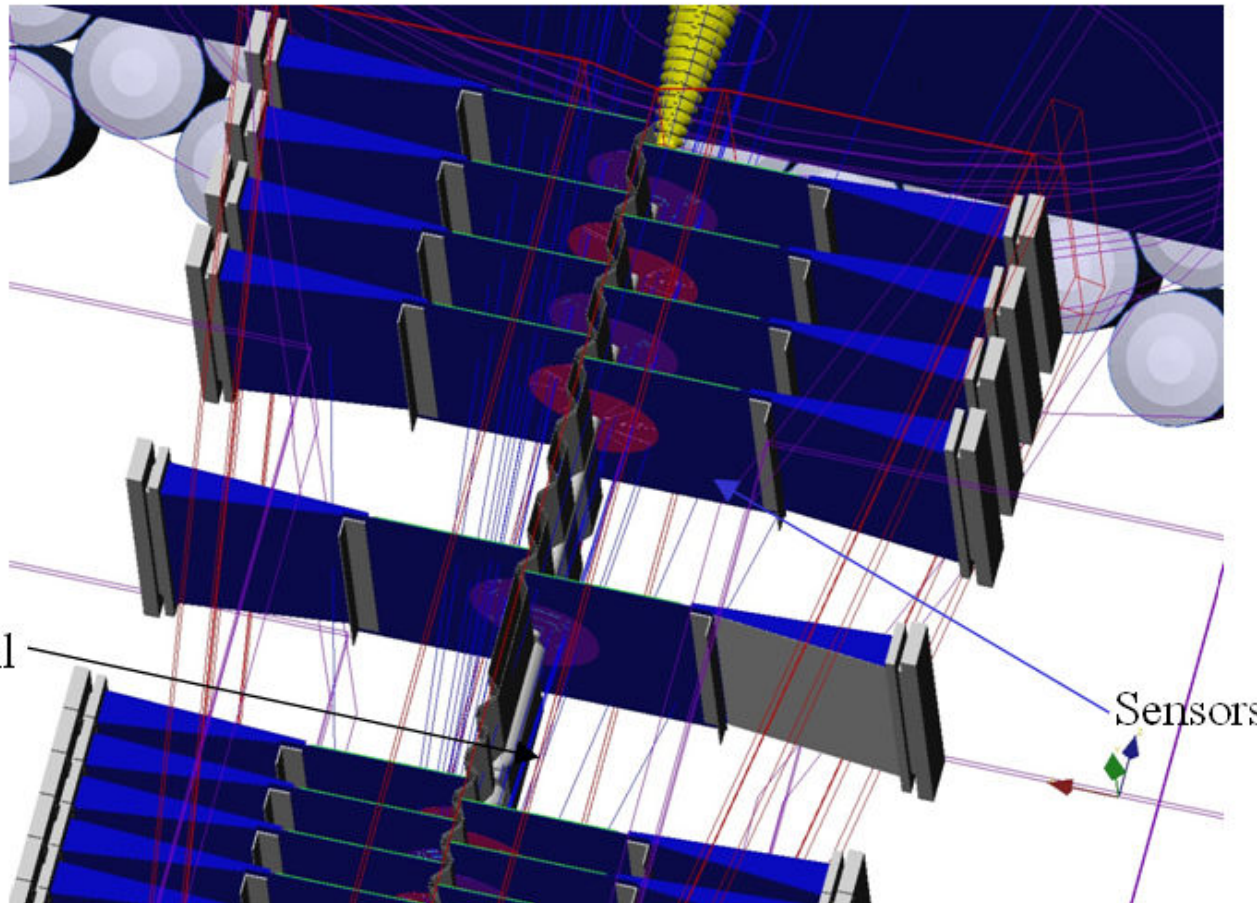

Complicated geometry  
Details are very important

Geant4 can handle it!!

LHCb Vertex Locator description

# HEP: Key strengths

## ⌘ Flexible geometry

- ☑ Able to cope with deep hierarchies, many volumes (for big experiments)
- ☑ Fast, easy to create & revise (for small experiments)

## ⌘ Open, Solid Physics

- ☑ Solid EM physics models
- ☑ Hadronic models that can describe test beam results (typically to 10% for resolution)
- ☑ Can try from variety of models
  - ☒ Trade accuracy for speed

## ⌘ Transparency of results

# 'Near' HEP: Experiments and accelerators



## ⌘ Diverse small(er) experiments

- ☑ Rare-Event (typically underground)

- ☑ Nuclear

  - ☒ Model detector response

## ⌘ Modeling accelerator beams

- ☑ Effects of interactions with collimators



# Boulby Mine dark matter search Prototype Simulation

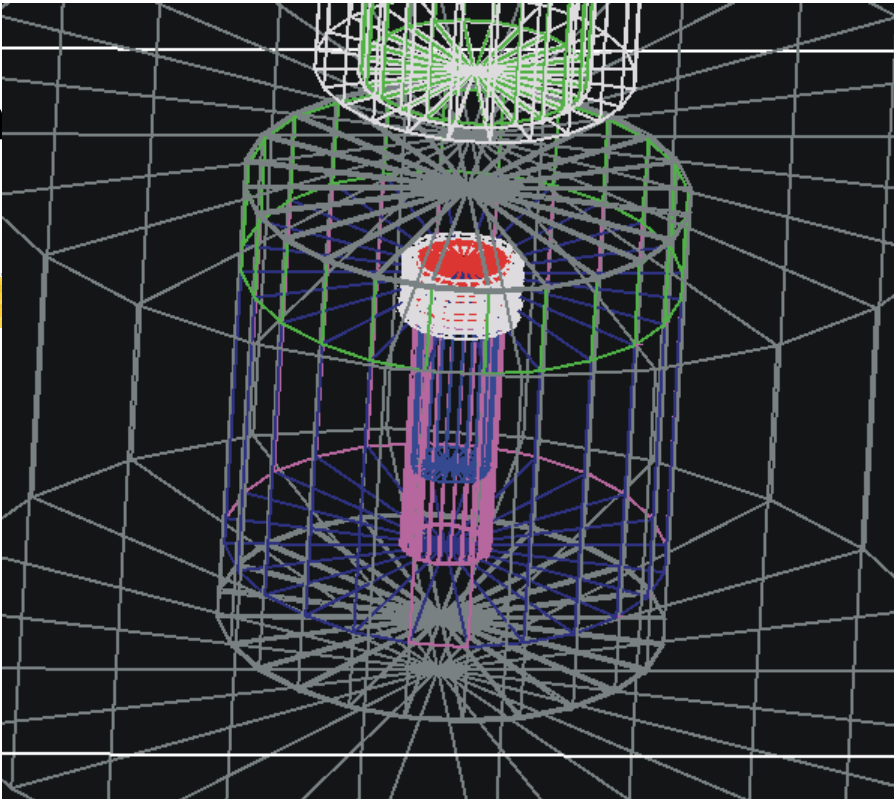
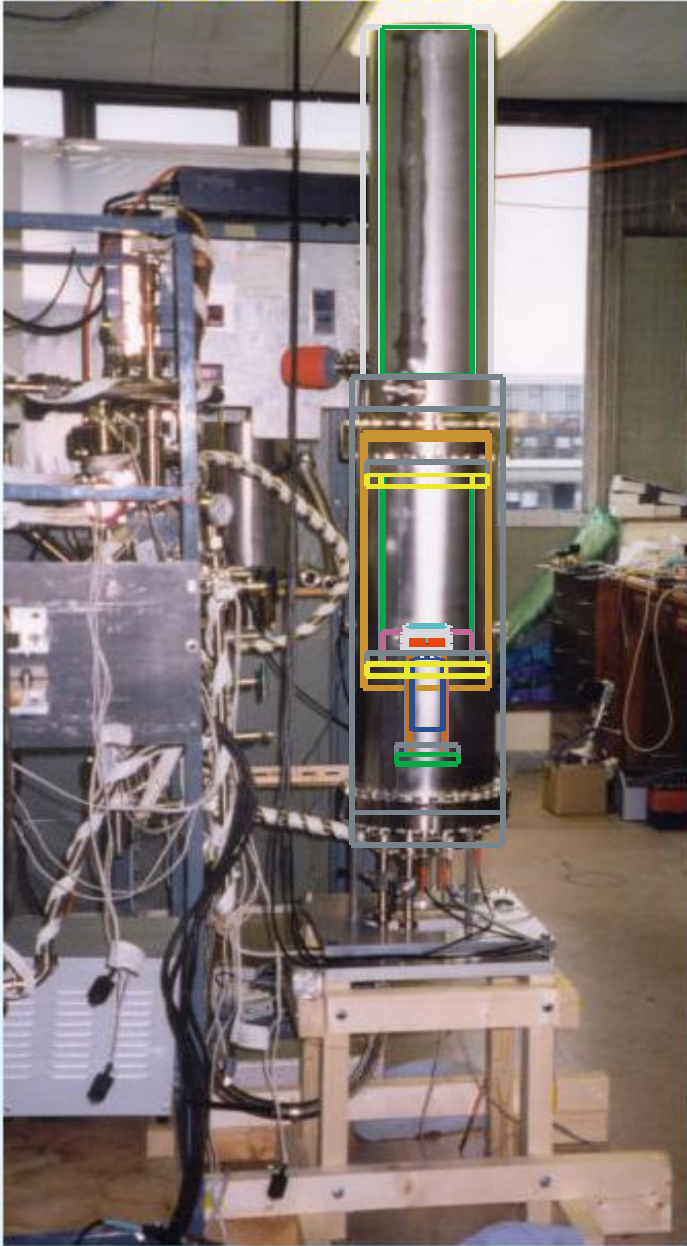

Courtesy of H. Araujo, A. Howard, IC London

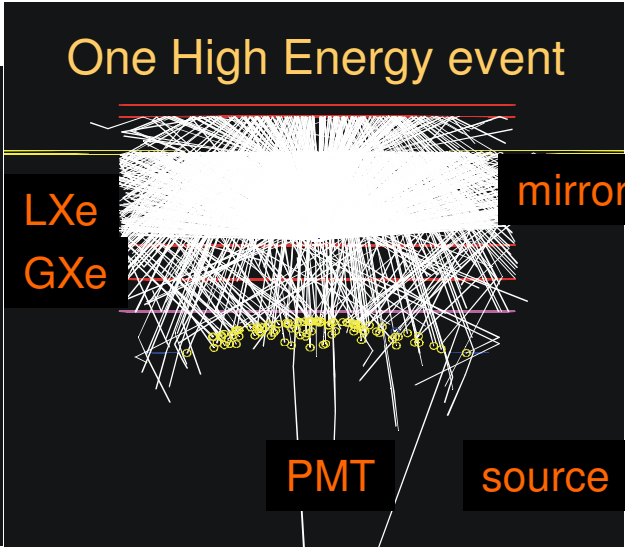
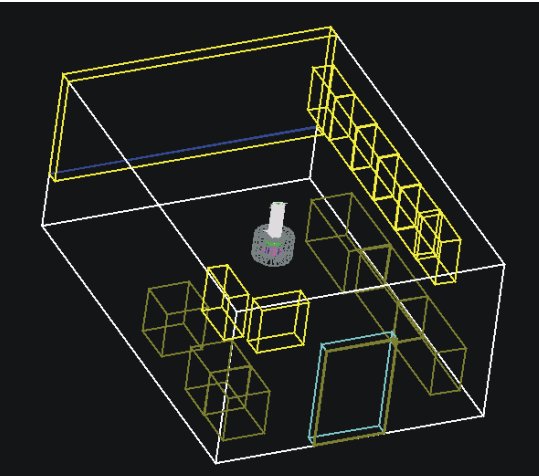

# Geant4 for beam transportation

## Example: Helical Channel

Published in proc. of PAC 2001  
(Fermilab-Conf-01-182-T)

72 m long solenoidal + dipole field with wedge absorbers and thin cavities

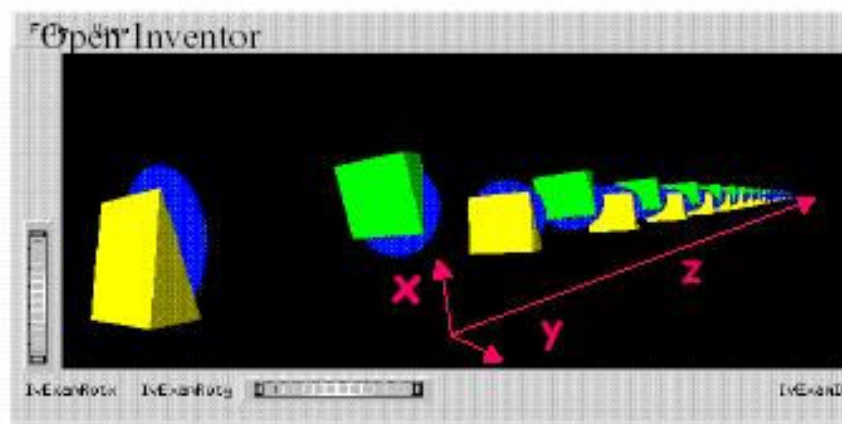

$$B_{xy} = B_T \cos, \sin \left( \frac{2p}{L} z \right) \quad B_z = B_0$$

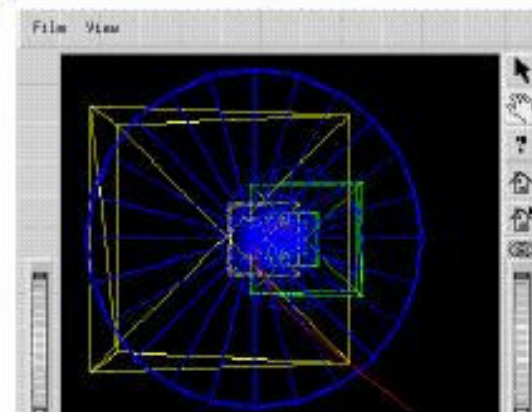

### Other simulations:

- Alternate Solenoid Channel (sFoFo), published in proceedings of PAC2001 and Feasibility Study II for a Neutrino Factory at BNL (2001)
- Bent Solenoid Channel, presented at Emittance Exchange Workshop, BNL 2000
- Low Frequency r.f. Cooling Channel, presented at International Cooling Experiment Workshop, CERN 2001
- Cooling Experiment (MICE) Simulation (in progress)

# Alternative/Beam Transport

Geant4 extensions for beam transport

⌘ BeamTools (FNAL, revised to 2003)

⌘ Microbeam studies (Bordeaux)

⌘ BDSIM

☞ <http://flc.pp.rhul.ac.uk/bdsim.html>

⌘ G4Beamline

☞ <http://www.muonsinc.com/tiki-index.php?page=G4beamline>



# **AEROSPACE**

# Space Applications

## ⌘ Model radiation environments

- ☒ Effect on satellite electronics

  - ☒ Numerous ESA missions

- ☒ Planetary radiation environments

  - ☒ Mars, Mercury, .. (Planetocosmics)

## ⌘ Science

- ☒  $\gamma$ -radiation produced by incoming cosmic ray protons

# RADSAFE on SEE in SRAMs

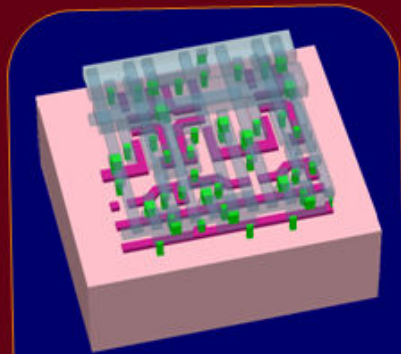

**TCAD Cell Structure: SRAM Cell**

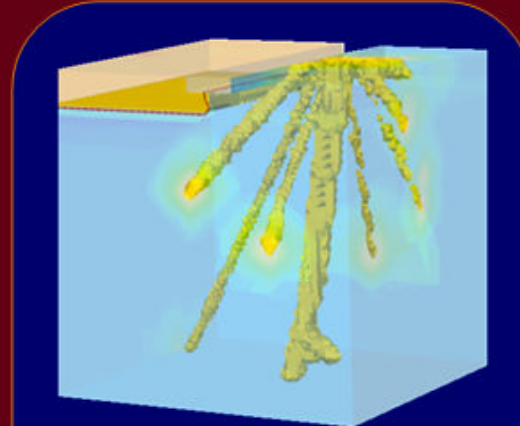

**Single Charge Deposition in TCAD: Ne+W Event**

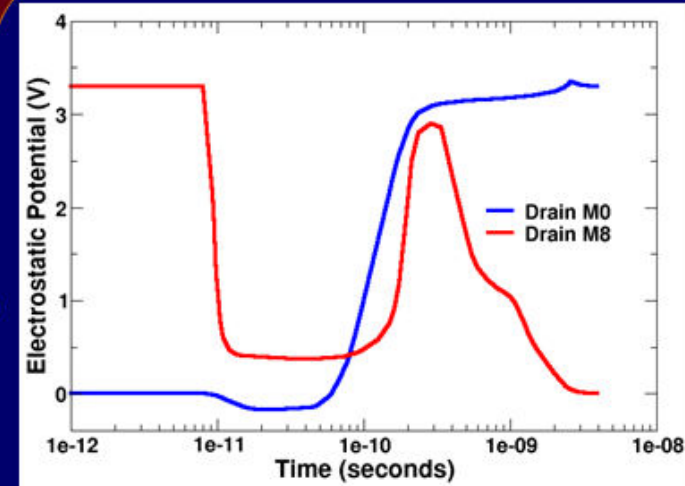

**SRAM Cell Upset**

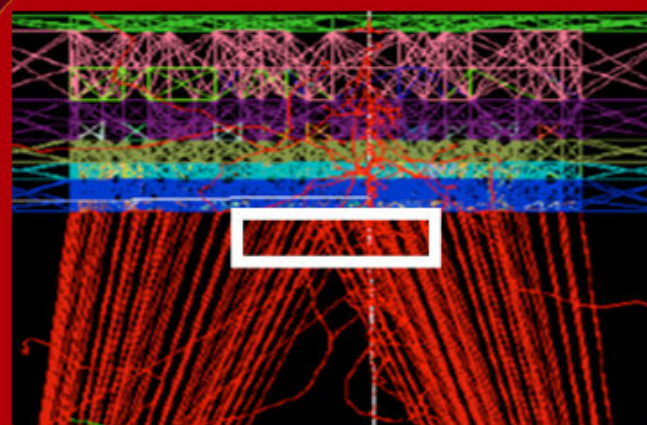

**Geant4 Geometry and 523 MeV Neon Event**

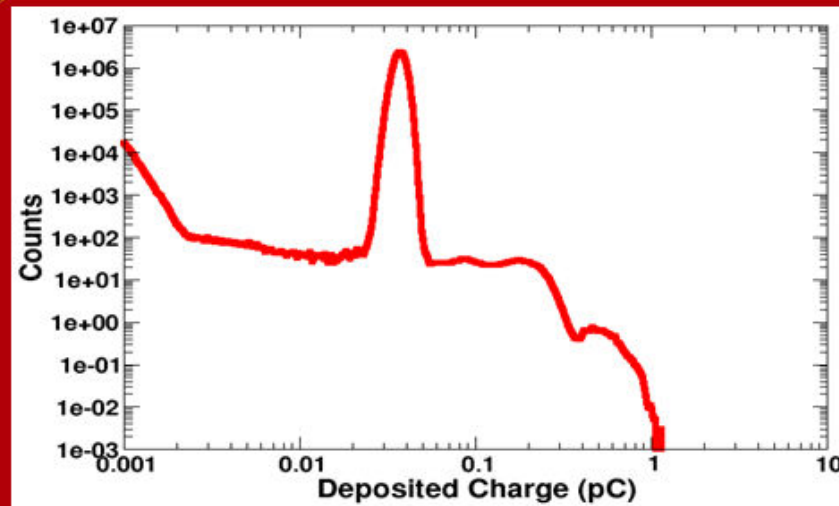

**MRED Energy Deposition for 10<sup>8</sup> Events**

# $\gamma$ astrophysics

AGILE

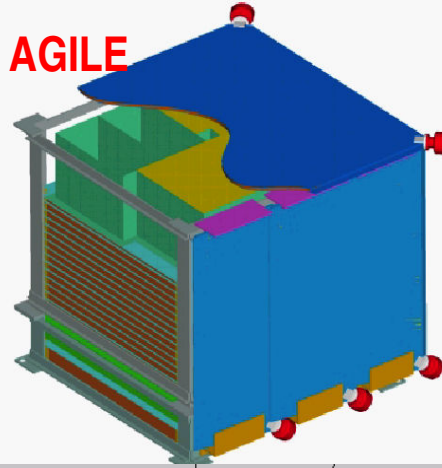

# GLAST

Some Dimensions are Distorted for Clarity of Presentation

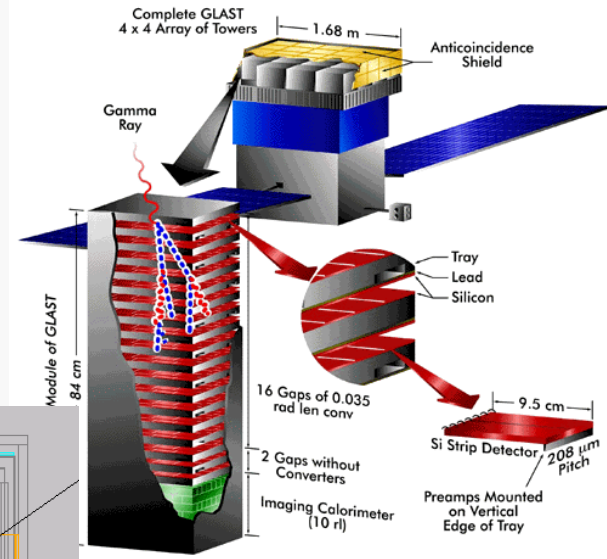

## $\gamma$ -ray bursts

BeppoSAX Observation of Gamma-Ray Burst on February 28, 1997

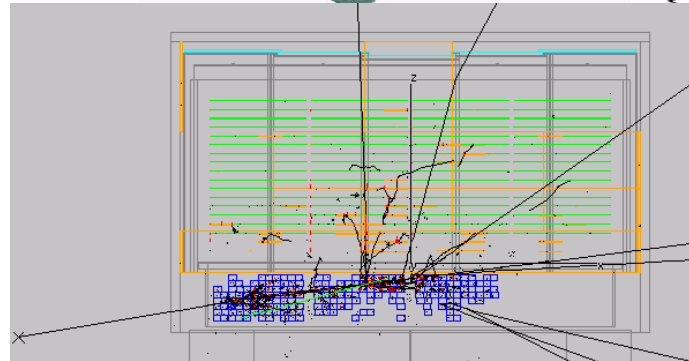
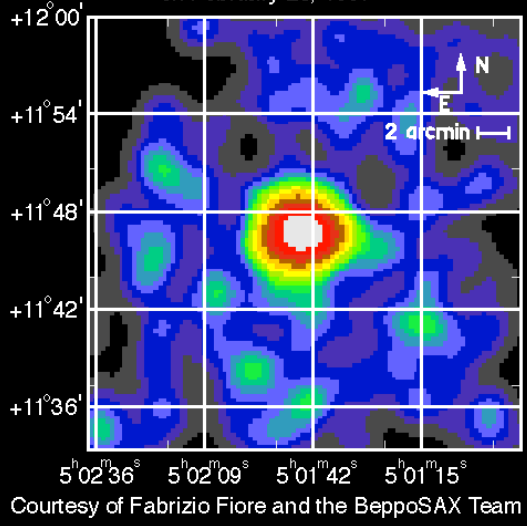

# GLAST

GLAST Hits Display

- Previous
- View XZ
- View YZ
- Zoom
- Unzoom
- New Center
- Reset 3D
- Marker +
- Marker -
- Save as Gif
- View X3D

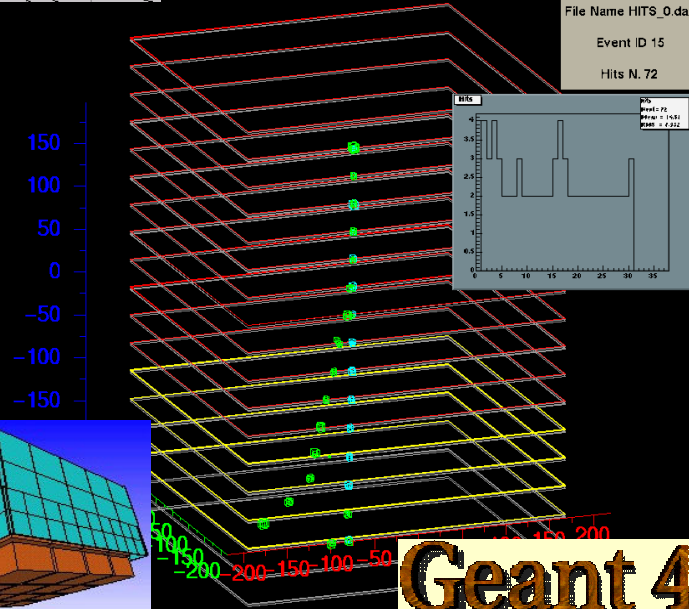

Typical telescope:  
*Tracker*  
*Calorimeter*  
*Anticoincidence*

- $\gamma$  conversion
- electron interactions
- multiple scattering
- $\delta$ -ray production
- charged particle tracking

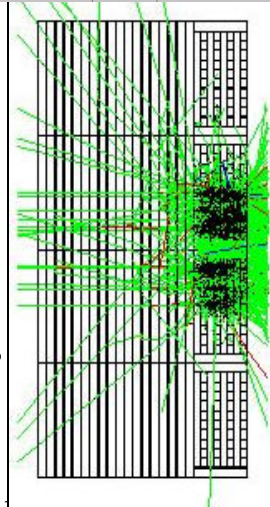
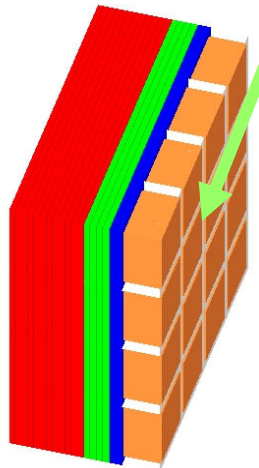

# Bepi Colombo: X-Ray Mineralogical Survey of Mercury

Space Environments  
and Effects Section



BepiColombo  
ESA cornerstone mission to Mercury

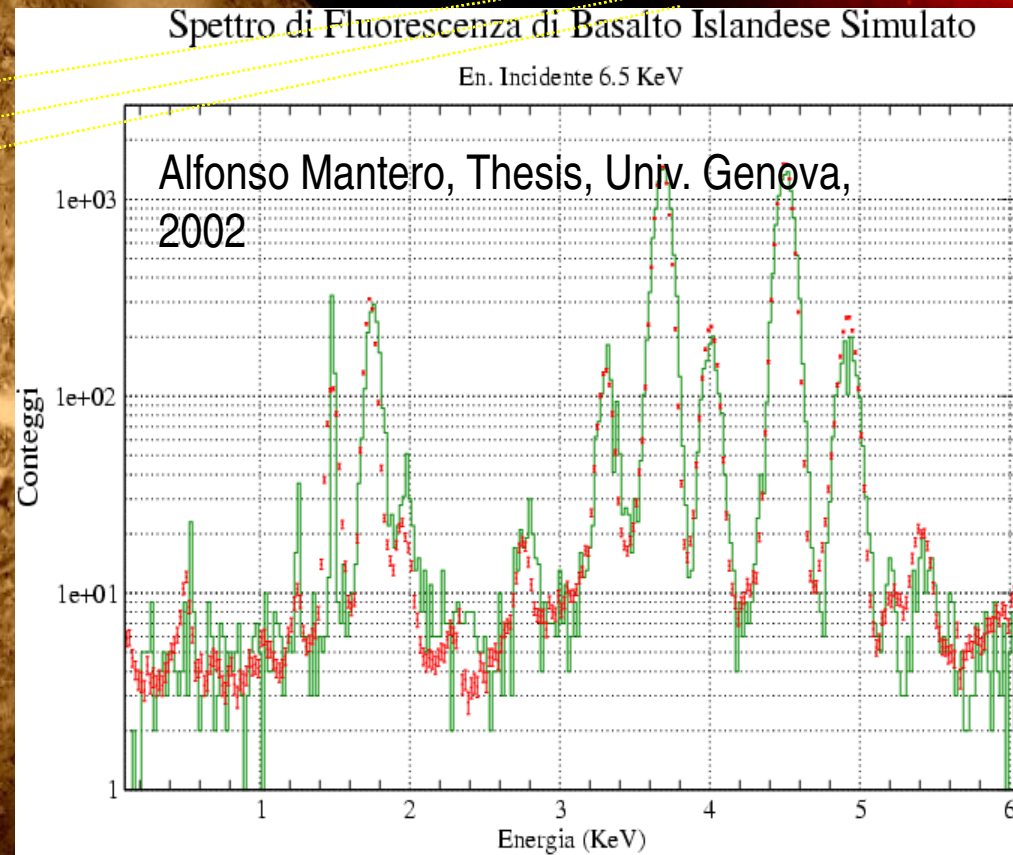
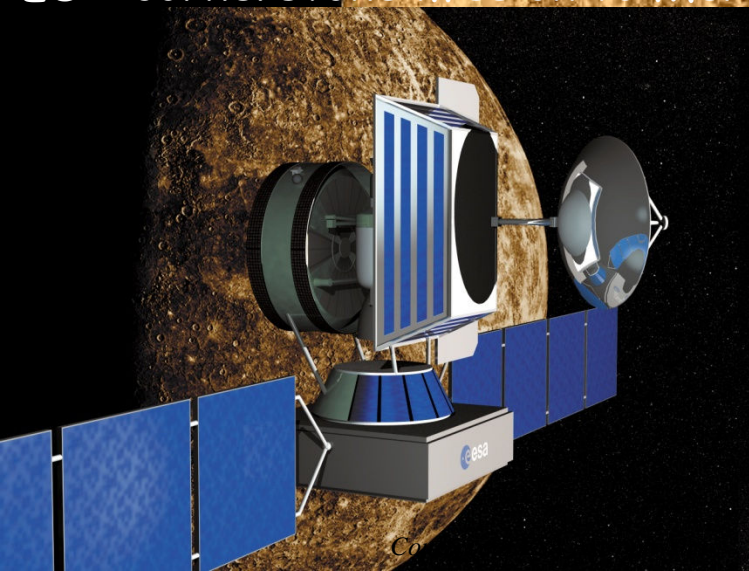





# PlanetoCosmics

## Geant4 simulation of Cosmic Rays in planetary Atmo-/Magneto- spheres

28th International Cosmic Ray Conference

— 4277

Cutoff Rigidities vs position

Geant4 Simulation of the Propagation of Cosmic Rays through the Earth's Atmosphere

L. Desorgher, E. O. Flückiger, M. R. Moser, and R. Bütikofer  
*Physikalisches Institut, University of Bern, CH-3012 Bern, Switzerland*

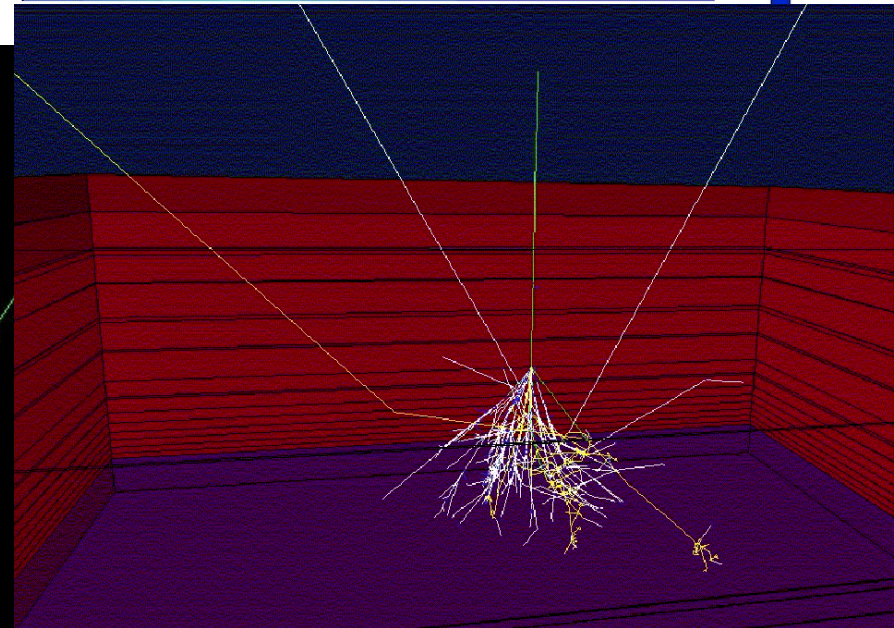
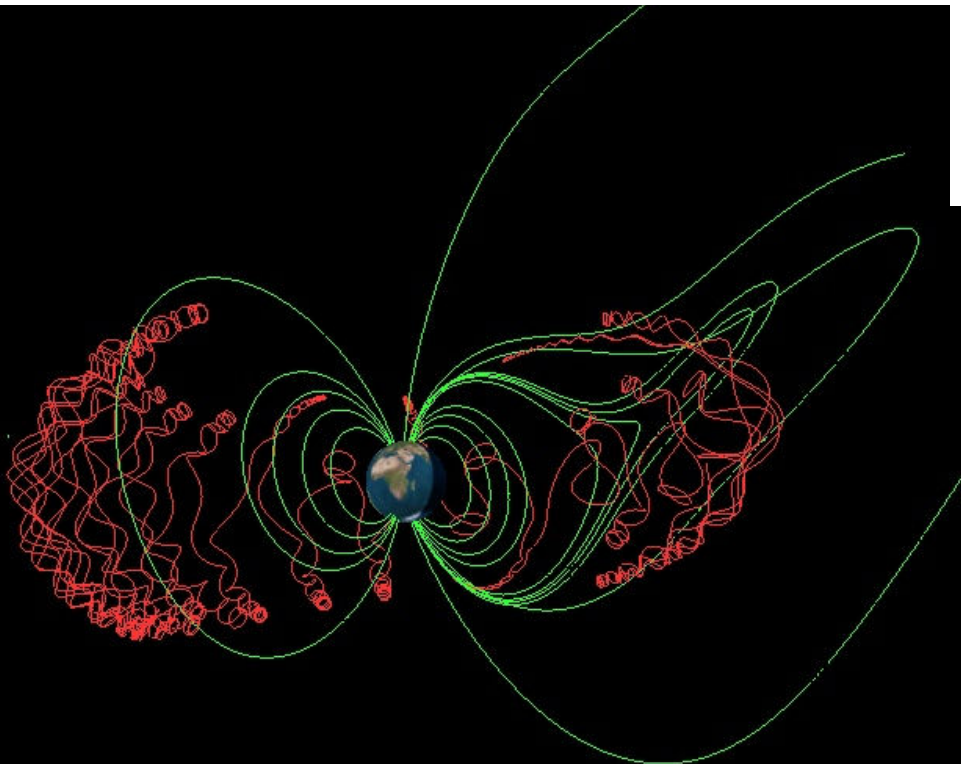
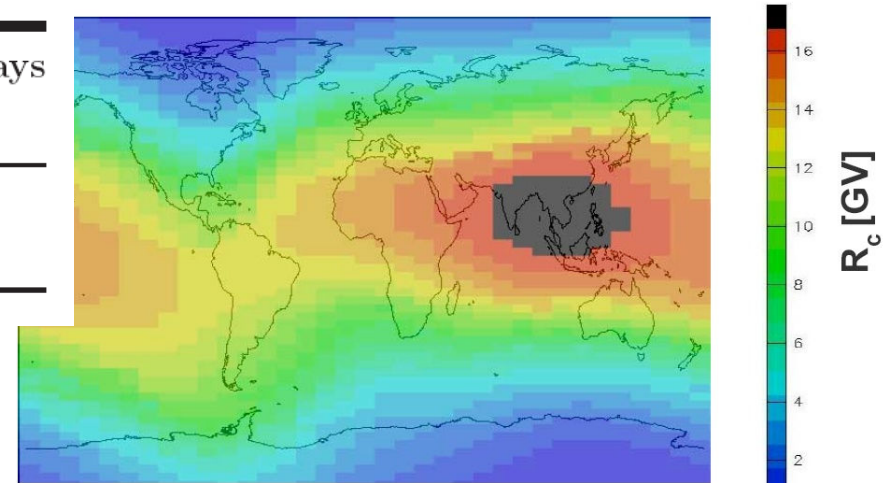



# **MEDICAL PHYSICS**

# Geometry examples of GATE applications

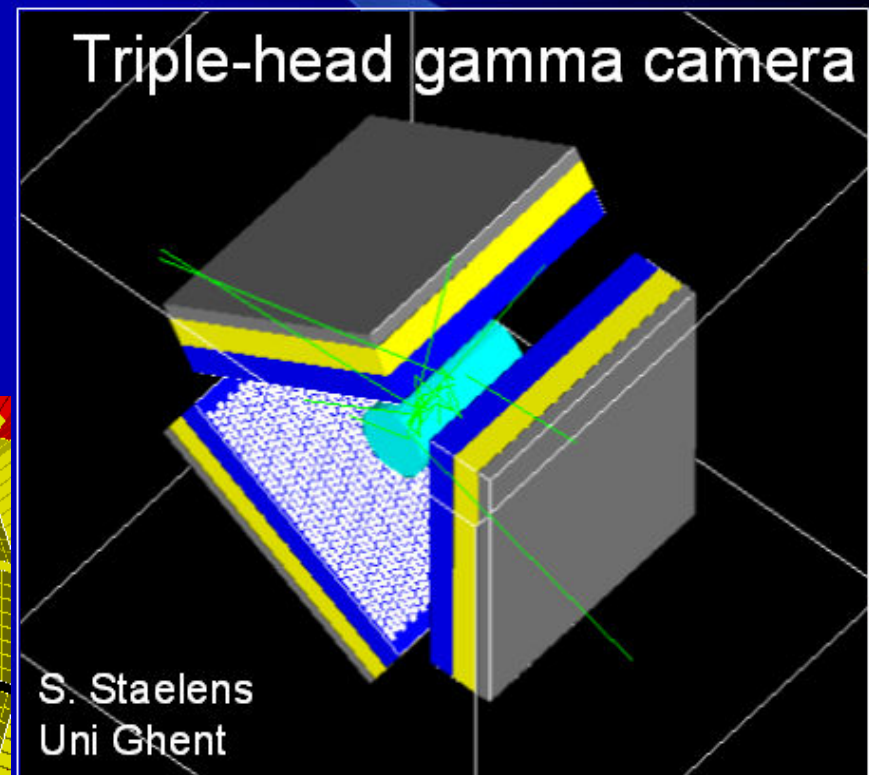
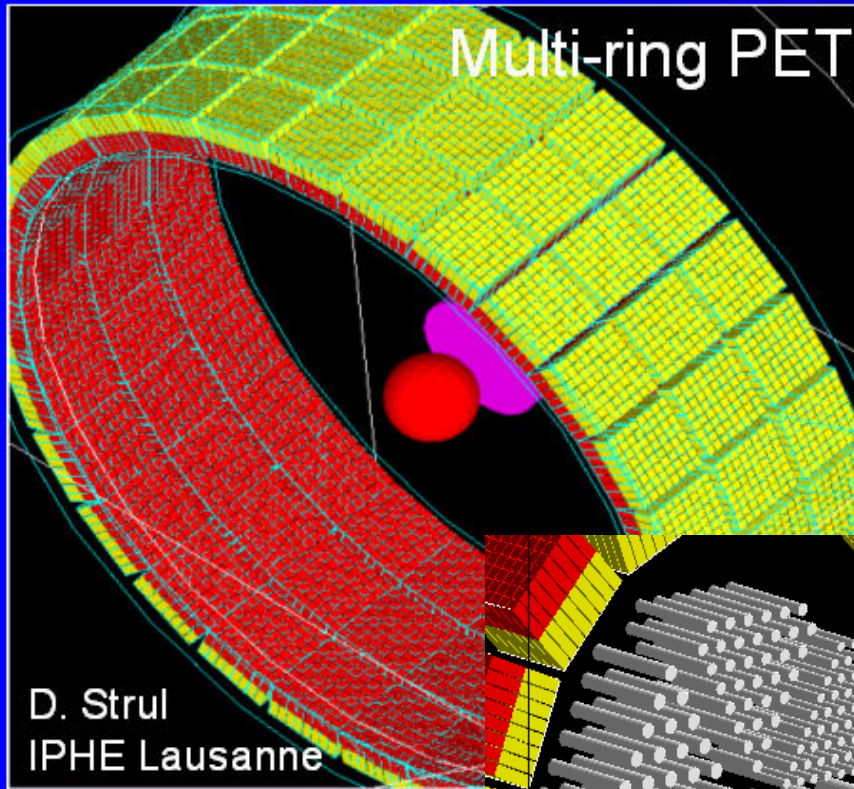



**HOTTEST  
ARTICLES**  
ON ScienceDirect

## INTRODUCTION

The **ScienceDirect TOP25 Hottest Articles** is a **free** quarterly service from ScienceDirect. When you subscribe to the **ScienceDirect TOP25**, you'll receive an e-mail every three months listing the ScienceDirect users' 25 most frequently downloaded journal articles, from any selected journal among more than 2,000 titles in the ScienceDirect database, or from any of 24 subject areas.

Now you can keep track of the latest trends in your speciality and find out what your colleagues are reading. A simple click on any of the listed articles will take you to the journal abstract, and of course, you have the option to download any article straight to your desktop, depending on your access rights.

Read more about [how the TOP25 is generated](#) and what it reflects.

Check out the ScienceDirect TOP25 Hottest Articles within your area of interest.

Subject Area:

Journal:

With these drop-down menus, the ScienceDirect TOP25 Hottest Articles are selected. Please refine your selection if necessary. To see the overall TOP25 within a certain subject area or journal, please select 'all subjects' or 'all journals' from the drop-down menus.

## TOP25 articles within the subject area: **Physics and Astronomy**

1. [Nanoscience and engineering in mechanics and materials](#) • Article  
*Journal of Physics and Chemistry of Solids, Volume 65, Issue 8-9, 1 August 2004, Pages 1501-1506*  
Chong, K.P.
2. [Geant4-a simulation toolkit](#) • Article  
*Nuclear Instruments and Methods in Physics Research Section A: Accelerators, Spectrometers, Detectors and Associated Equipment, Volume 506, Issue 3, 1 July 2003, Pages 250-303*  
Agostinelli, S.; Allison, J.; Amako, K.; Apostolakis, J.; Araujo, H.; Arce, P.; Asai, M.; Axen, D.; Banerjee, S.; Barrand, G.; Behner, F.; Bellagamba, L.; Boudreau, J.; Broglia, L.; Brunengo, A.; Burk
3. [Radiation pneumonitis and pulmonary fibrosis in non-small-cell lung cancer: Pulmonary function, prediction, and prevention](#) • Article



# **A QUICK WALK THROUGH GEANT4**

# Geometry: what it does

## Describes a Setup

- ⌘ Hierarchy of volumes
- ⌘ Many volumes repeat
  - ☑ Volume & sub-tree
- ⌘ Up to hundreds of thousands of volumes
- ⌘ Importing solids from CAD systems

## Navigates in Detector

- ⌘ Locates a point
- ⌘ Computes a step
  - ☑ Linear intersection

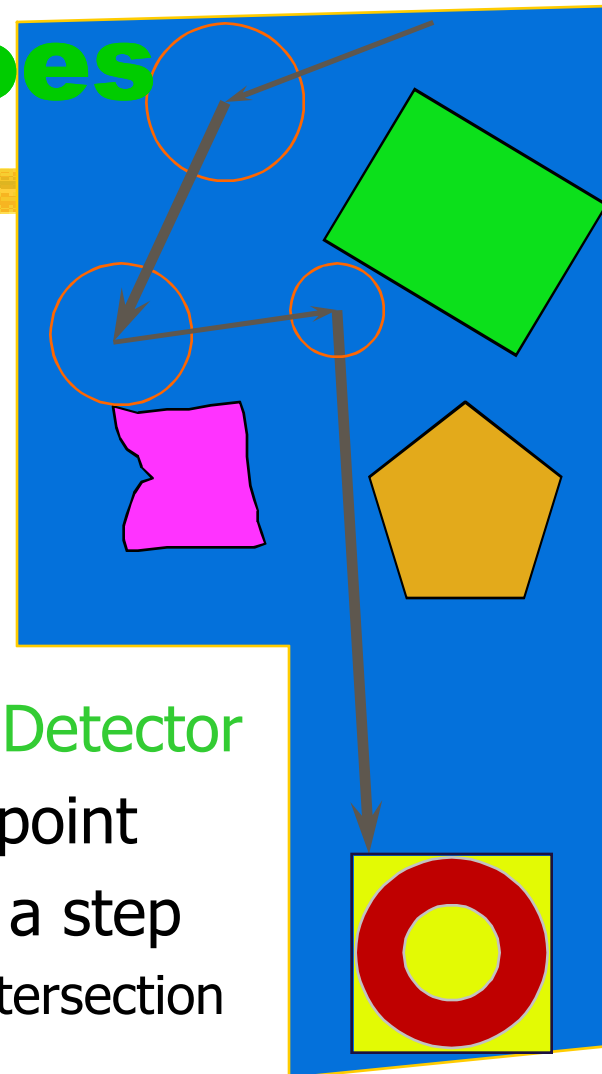

# Electromagnetic physics

## ⌘ Gammas:

- ⊞ Gamma-conversion, Compton scattering, Photo-electric effect

## ⌘ Leptons( $e$ , $\mu$ ), charged hadrons, ions

- ⊞ Energy loss (Ionisation, Bremsstrahlung), Multiple scattering, Transition radiation, Synchrotron radiation,  $e^+$  annihilation.

## ⌘ Photons:

- ⊞ Cerenkov, Rayleigh, Reflection, Refraction, Absorption, Scintillation

⌘ High energy muons

## ⌘ A choice of implementations for most processes

- ⊞ "Standard": performant when relevant physics above 1 KeV

- ⊞ "Low Energy": Extra accuracy for application delving below 1 KeV

# Hadronic processes

- ⌘ Hadronic physics is included in Geant4
  - ☑ a powerful and flexible framework and
  - ☑ implementations of physics X-sections & models.
- ⌘ A variety of models and cross-sections
  - ☑ for each energy regime, particle type, material
  - ☑ alternatives with different strengths and computing resource requirements
- ⌘ Components can be assembled in an optimised way for each use case.



# Openness and Extensibility

⌘ As a toolkit with open-source code, Geant4 can be extended in many ways

☑ Expected/simple

☒ Creating a new shape (G4VSolid)

☑ Unusual, but predicted

☒ New processes, for physics or user action

☑ Radical extensions

☒ Reversing time (two ways)

☒ Creating 'on-the-fly' density for a material (future)



# **GEANT4 COLLABORATION**

# Geant4 Collaboration

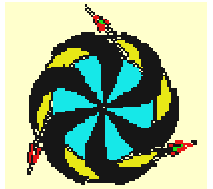
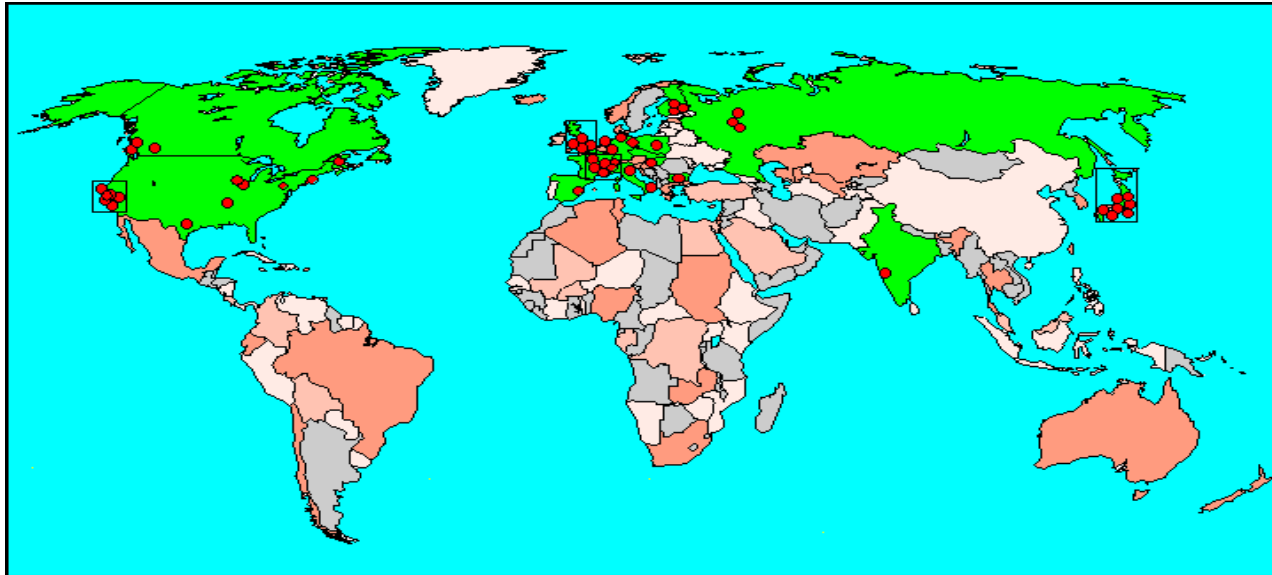

TRIUMF



Lebedev



Collaborators also from non-member institutions, including  
 IHEP  
 MEPHI Moscow  
 Jefferson Laboratory

LIP

UK STFC

# Hands on!

- Time to get your hands on Geant4
  - Copy exercises
  - Your first run of a simple example
- To start, please look at

<http://www.ifh.de/geant4/g4course2010>

Else, if you have difficulty to reach that use

<http://www-zeuthen.desy.de/geant4/g4course2010>

The END

# Resources for more information

## ⌘ Geant4 web site

⊞ <http://cern.ch/geant4/>

## ⌘ Geant4 Training Page

⊞ <http://cern.ch/geant4/support/> and follow "Training" link,

⊞ Geant4 training INFN / EM 'Low-energy'

⊞ <http://www.ge.infn.it/geant4/training/>

## ⌘ Geant4 Workshops and Users Workshops presentations

⊞ Latest at the home page, previous at [http://geant4.web.cern.ch/geant4/collaboration/meetings\\_minutes.html#G4workshops](http://geant4.web.cern.ch/geant4/collaboration/meetings_minutes.html#G4workshops)

Note: "Training" page is also directly accessed at <http://cern.ch/geant4/milestones/training/training-milestone.html>

## ⌘ Geant4 Physics WG web sites

⊞ Which can all be found at [http://cern.ch/geant4/organisation/working\\_groups.html](http://cern.ch/geant4/organisation/working_groups.html)

⊞ Geant4 Low-Energy Electromagnetic WG web site

⊞ <http://www.ge.infn.it/geant4/lowE/>

⊞ Geant4 EM (standard) see below

⊞ Geant4 Hadronic WG home

## ⌘ Papers on G4 and its validation

⊞ "Geant4: a simulation toolkit", Nucl Instr and Methods **A** 506 (2003), 250-303

⊞ "Validation of GEANT4, an object-oriented MC toolkit for simulations in medical physics" J.F. Carrier et al, Med Phys 32 (2004), p 484.

ElectroMagnetic (standard) WG home page is at [http://cern.ch/geant4/working\\_groups/electromagnetic/electromagneticWG.html](http://cern.ch/geant4/working_groups/electromagnetic/electromagneticWG.html)

# Geant4 Capabilities & Use

- **Kernel**: create geometry, hits, ...
- **Physics Processes**
  - models for EM, hadronics, ...
  - ‘assembled’ into physics lists for application area
- Tools for **faster** simulation
  - Shower parameterisation & Event biasing.
- Open **interfaces** for input/output
  - User commands, visualization
- Verification and validation for use cases
- Using it
  - via ready applications (eg GATE)
  - by starting with examples & customising

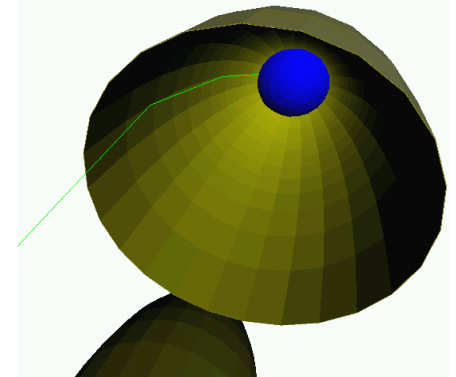

# *Practical considerations*

## ⌘ Starting off / Installation

- ⊞ Need CLHEP, vis 'drivers'
- ⊞ Compatible platform

## ⌘ Interacting with an application

- ⊞ Command line interface
  - ⊞ /gun/particle proton
  - ⊞ /run/beamOn 10
- ⊞ GUI

## ⌘ 'Coding' (if necessary)

- ⊞ Modifying existing C++ 'code' to describe your setup
- ⊞ For advanced uses, creating you own class to describe eg a magnetic field.

## Platforms

### ⌘ What works 'best'

- ⊞ Linux and gcc 3.2.3
  - ⊞ most developers & HEP institutions use this
  - ⊞ Today Jan 2005 'Scientific Linux' 3 and 4
- ⊞ Windows (XP) & Vis C++ 7.1
  - ⊞ numerous users

### ⌘ What we expect to work

- ⊞ Other Linux flavours with
  - ⊞ Gcc 3.2.3, 3.4.6, 4.1.1
  - ⊞ Possibly with fewer options, eg missing some visualisation

### ⌘ What others 'ported' and check

- ⊞ Mac OS X, Sun Solaris



# Geant4 releases: 1999-2009

RD44

- ⌘ Dec 1998 - Geant4.0.0 release
- ⌘ June 2001 - Geant4 3.2 release
- ⌘ Dec 2005 – Geant4 8.0
- ⌘ Jun 2006 – *Geant4 8.1 release*
- ⌘ May 2007 – Geant4 8.3
- ⌘ Jun 2007 – Geant4 9.0
- ⌘ Dec 2008 – Geant4 9.2
- ⌘ Dec 2009 – Geant4 9.3

Before: Two public releases per year.

Since 2008: one beta (June), one full rel.

*MoU-based  
Collaboration*

G4 license,  
New G4  
collaboration

# Acknowledgements

**Thanks** to those who have contributed

- to creating slides for tutorials / talk, that I borrowed

**Thanks** to all those who have contributed

- to the development of Geant4,

- to its validation for these and other application areas,

- to those who have applied it

- particularly those who have given feedback.

Note that it is a large task to give credit to all of them individually.