



**PHYSICS POTENTIAL OF AN EXTENDED
TEVATRON RUN**

**URSULA BASSLER
ON BEHALF OF THE D0 AND CDF
COLLABORATIONS
IRFU/SPP CEA-SACLAY**

Thanks in particular to Darian Wood for his HCP slides!



- The Context: Tevatron, CDF & Dzero, LHC
- Physics opportunities
 - Complementary Tevatron/LHC measurements
 - Legacy measurements
 - Higgs and other opportunities for discovery

INTEGRATED LUMINOSITY AND SCHEDULE

Tevatron Run II Integrated Luminosity and Projection

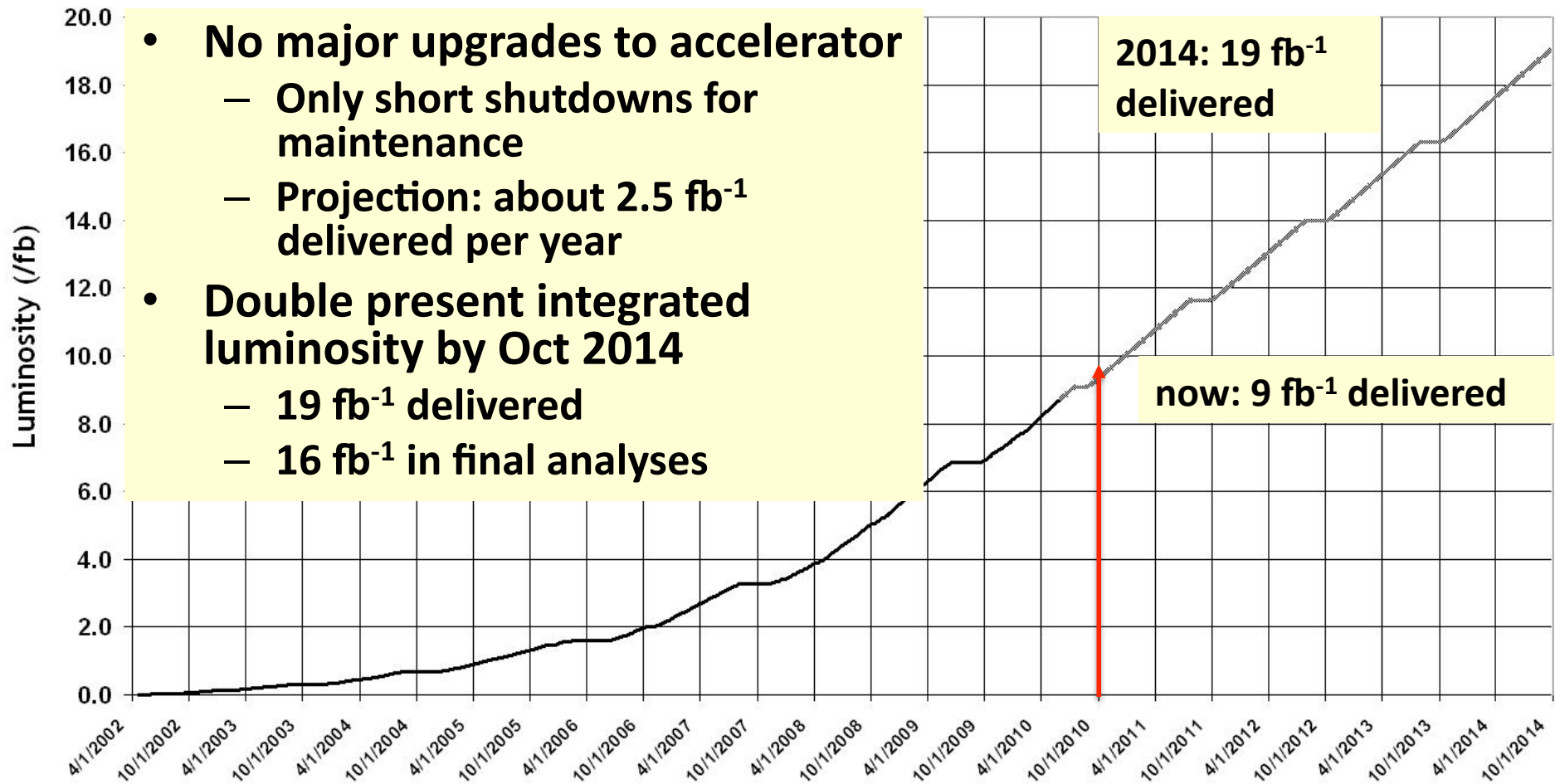

- **No major upgrades to accelerator**
 - Only short shutdowns for maintenance
 - Projection: about 2.5 fb⁻¹ delivered per year
- **Double present integrated luminosity by Oct 2014**
 - 19 fb⁻¹ delivered
 - 16 fb⁻¹ in final analyses

INTEGRATED LUMINOSITY AND SCHEDULE

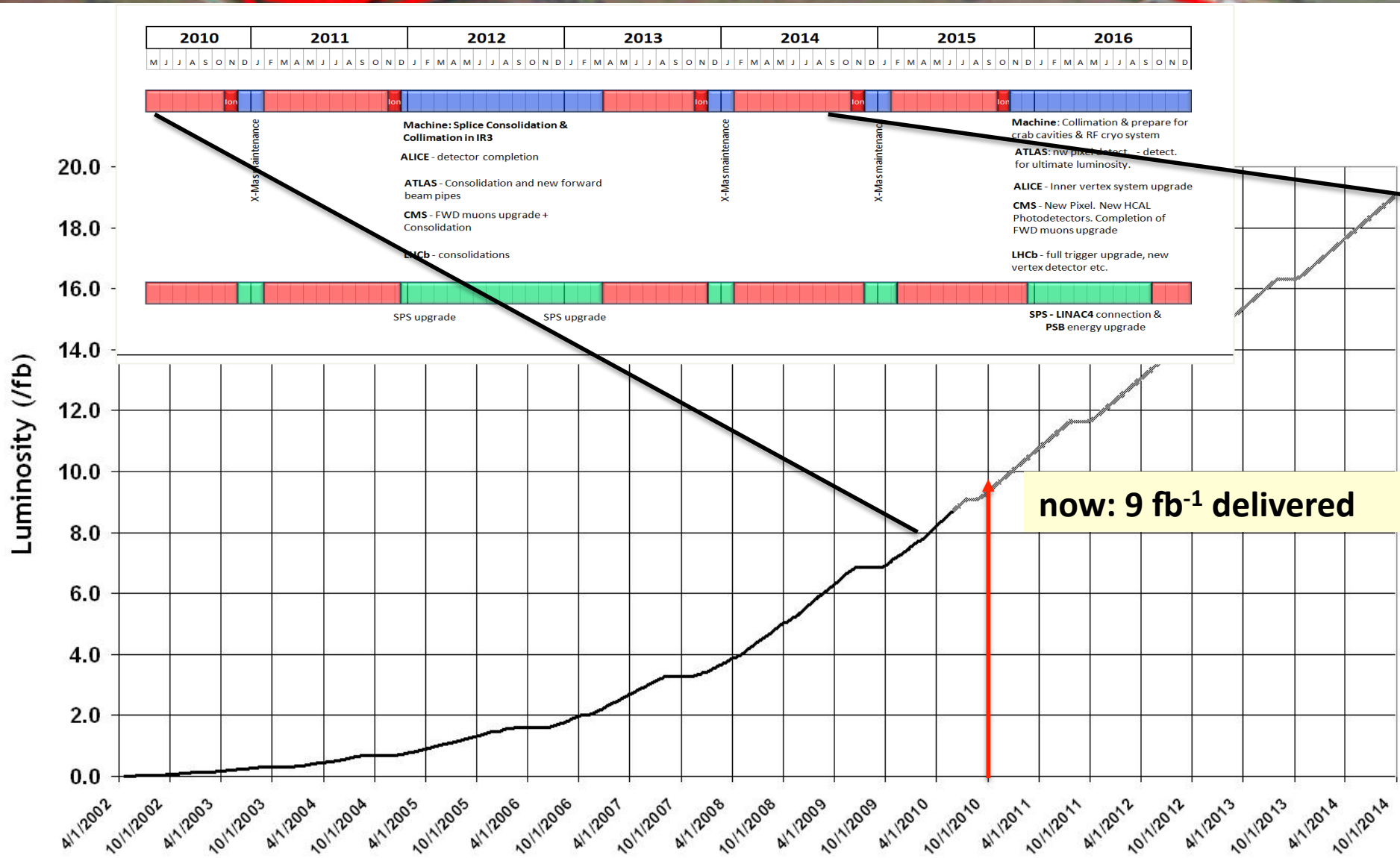

CDF AND DZERO DETECTORS

- Detectors operating stably for many years
 - Existing 9 fb^{-1} of luminosity has been used to track ageing effects
- Main attention is focused on aging of tracking detectors
 - Fermilab review in June 2010

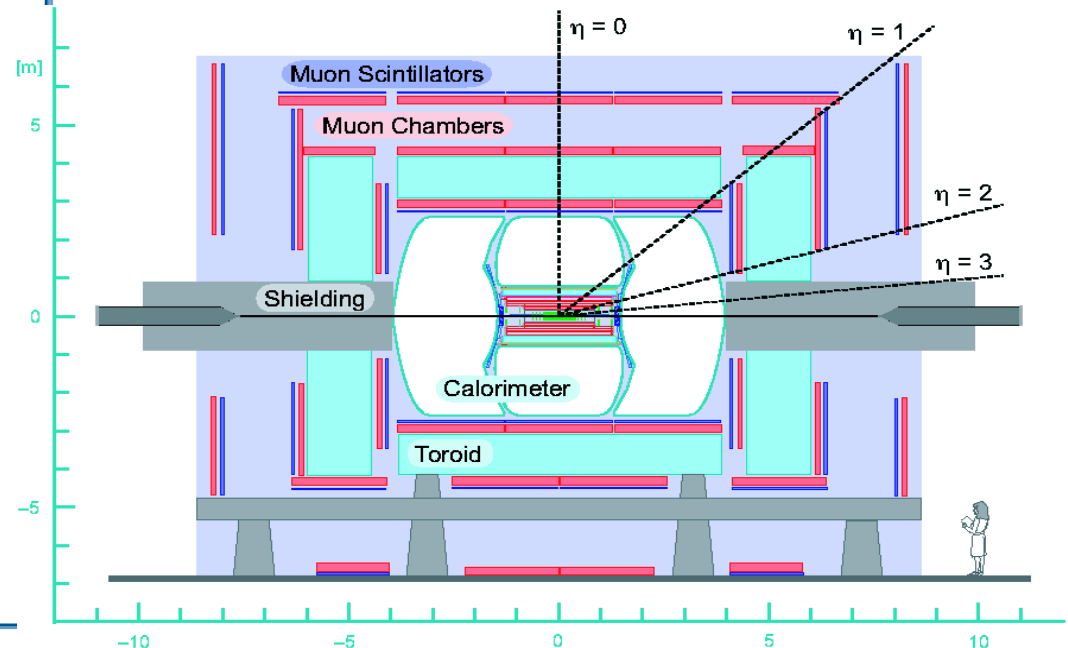
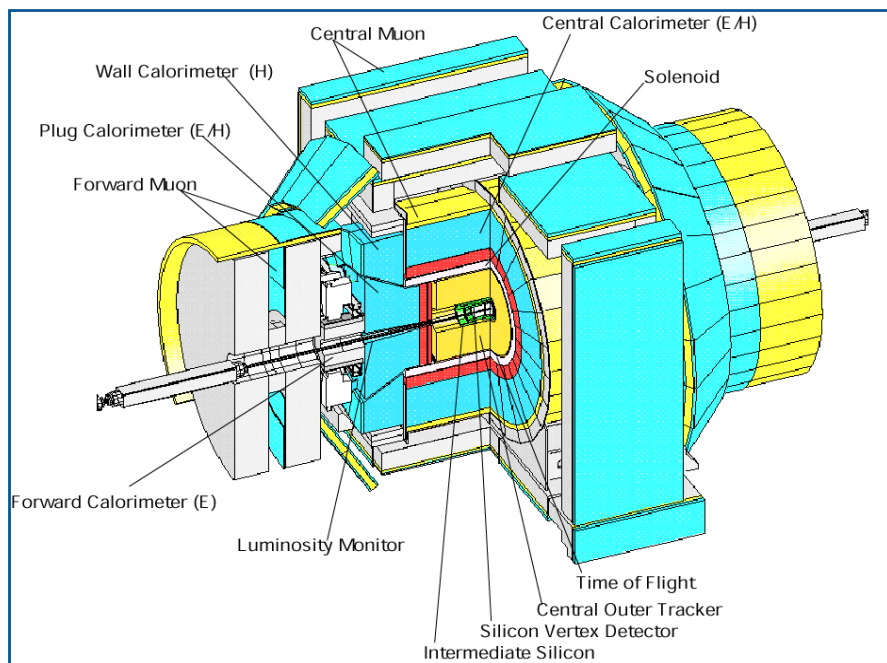

CDF AND DZERO DETECTORS

- Detectors operating stably for many years
 - Existing 9 fb^{-1} of luminosity has been used to track ageing effects

Example: CDF Central Outer Tracker (drift chamber)

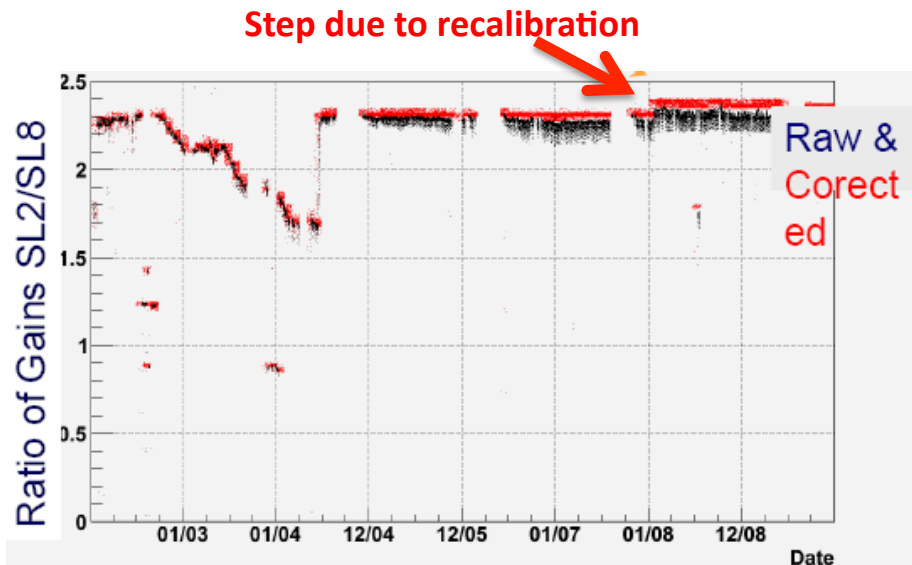

- Main attention is focused on aging of tracking detectors
 - Fermilab review in June 2010

Example: Dzero Silicon Microstrip Detector: Layer 1 will be touched beyond 10 fb^{-1}

Ø Silicon Detector Radiation Aging Status as of Jan. 2010

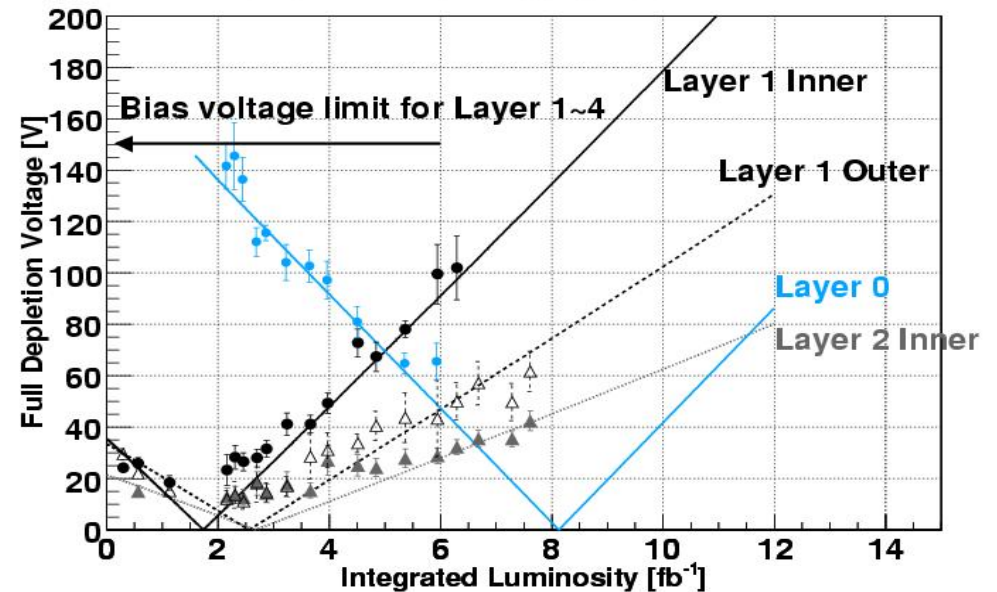

HIGGS PROJECTION

Tevatron Preliminary Higgs Projection

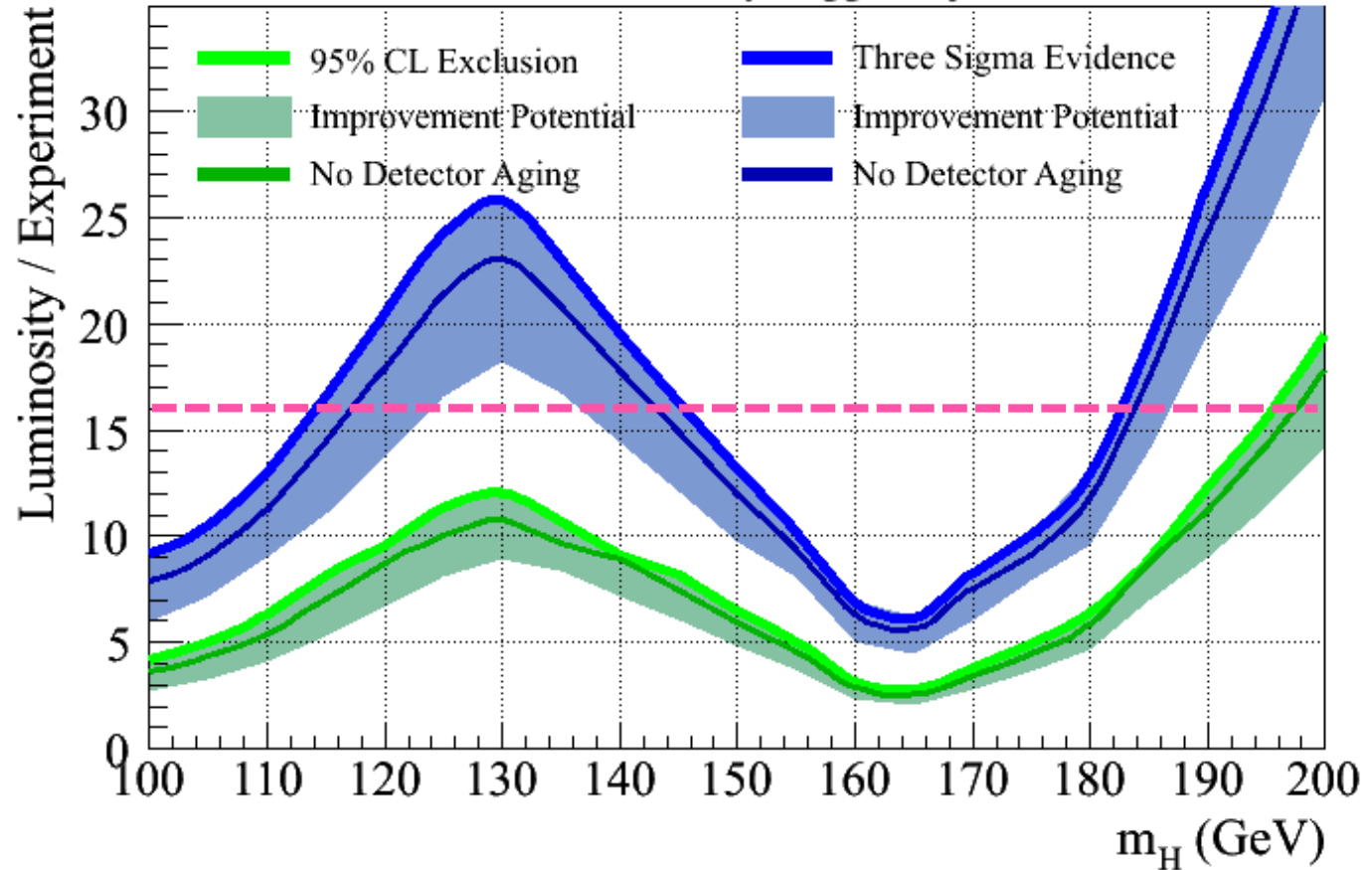

D0 only

Essentially no
Detector aging
effects
expected for
CDF

With 16 fb⁻¹ at the Tevatron, expect:

- 95% CL exclusion (and stronger) over whole range $m_H < 190$ GeV
- 3σ evidence, in $100 < m_H < 180$ GeV
- 4σ evidence for $m_H = 115$ GeV

HIGGS IMPROVEMENTS

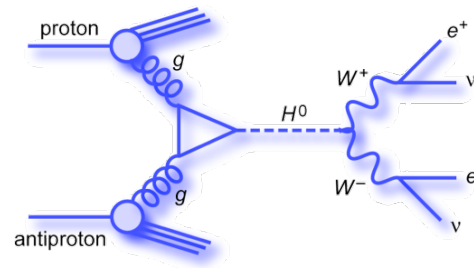
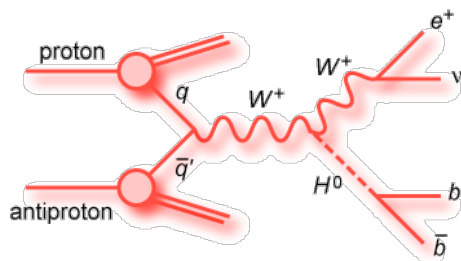
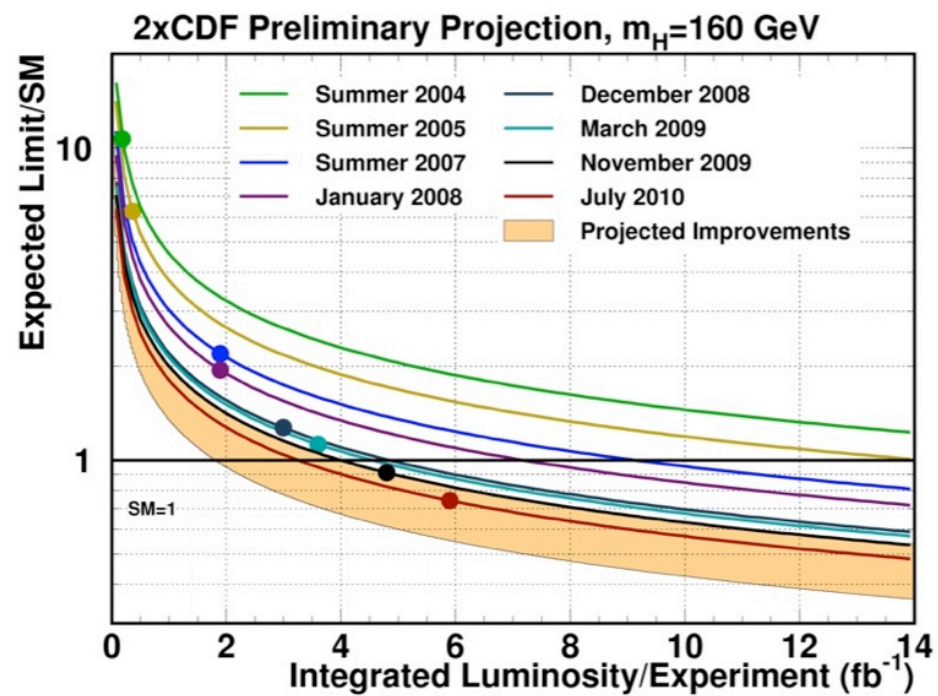
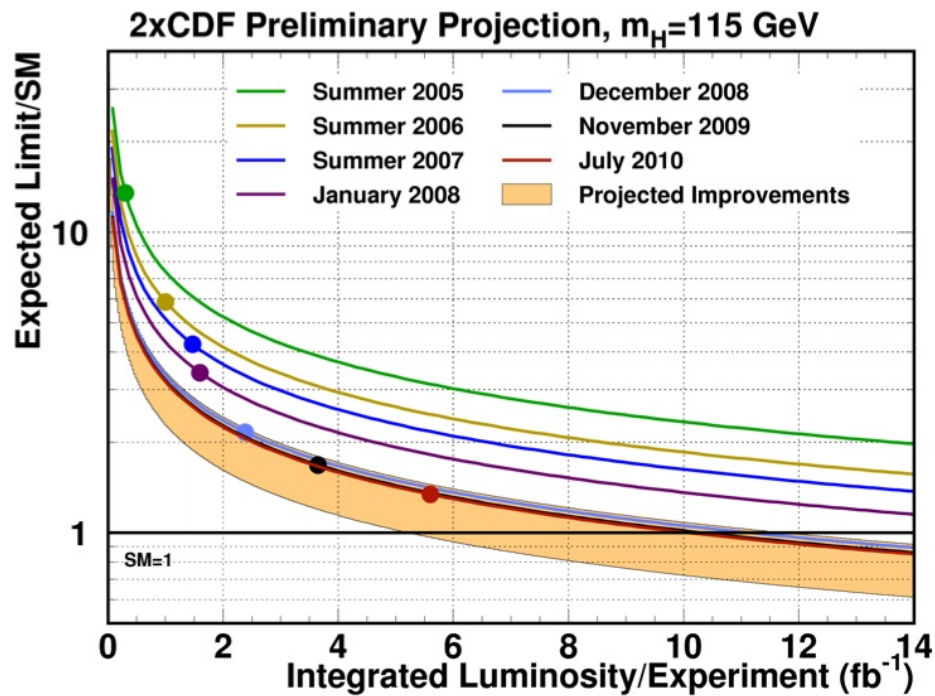

HIGGS PROJECTION

Tevatron Preliminary Projection

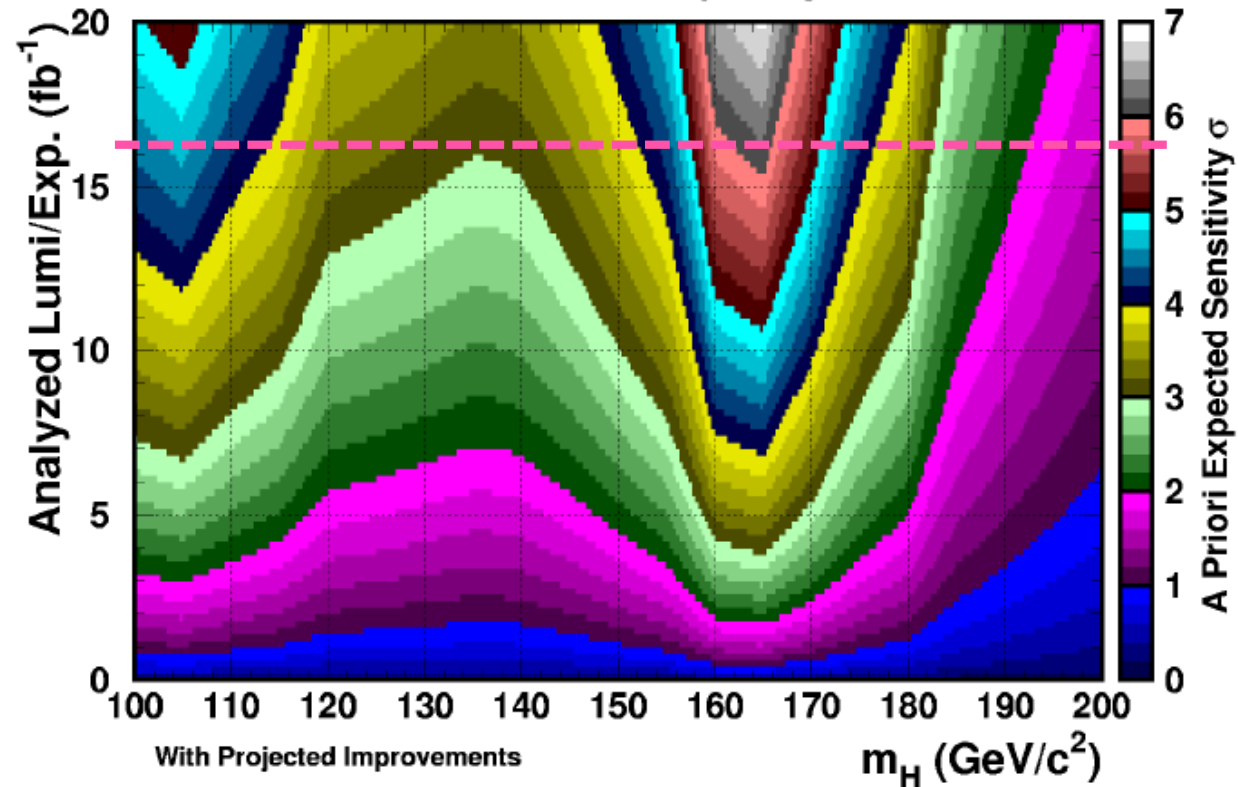

With 16 fb⁻¹ at the Tevatron, expect:

- 95% CL exclusion (and stronger) over whole range $m_H < 190$ GeV
- 3σ evidence, in $100 < m_H < 180$ GeV
- 4σ evidence for $m_H = 115$ GeV

COMPLEMENTARY: NATURE OF THE SM HIGGS

Low mass Higgs search at the LHC relies on $H \rightarrow \gamma\gamma$ and $H \rightarrow \tau\tau$

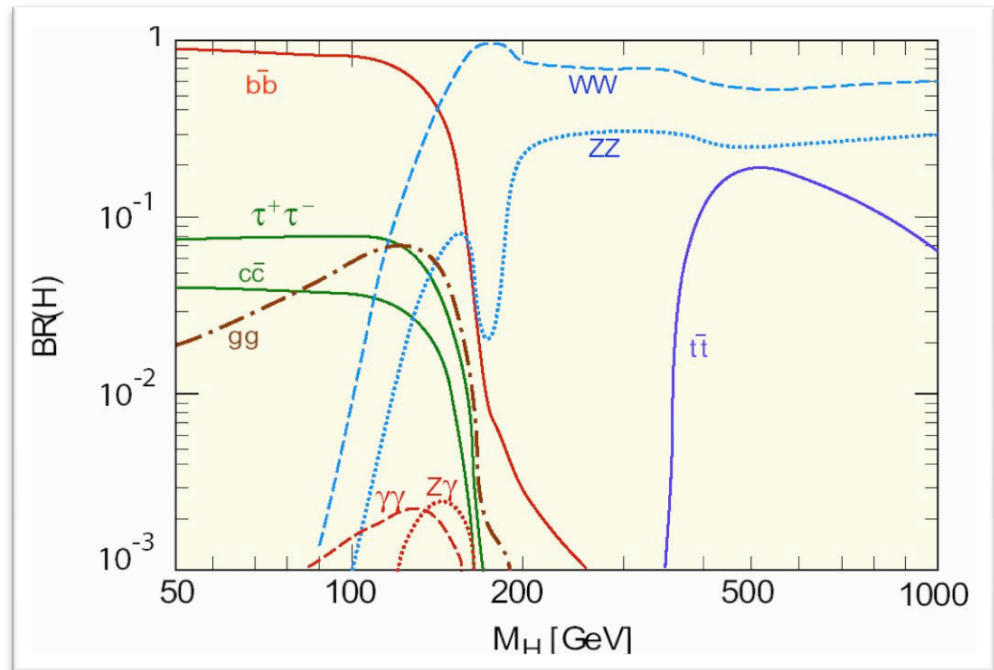
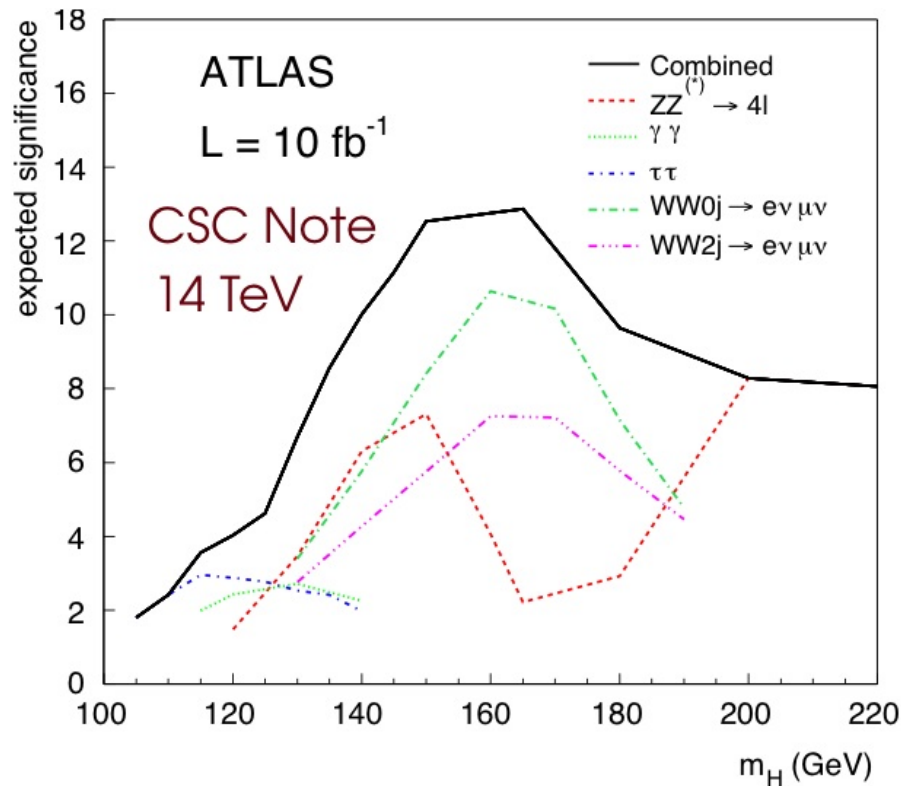

Yet observation of Higgs decays into b-jets is an important signature not to be missed!

FUTURE LEGACY: W MASS

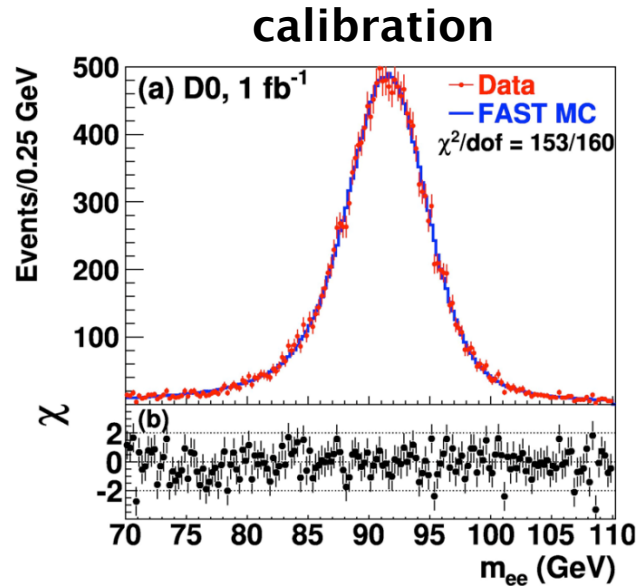
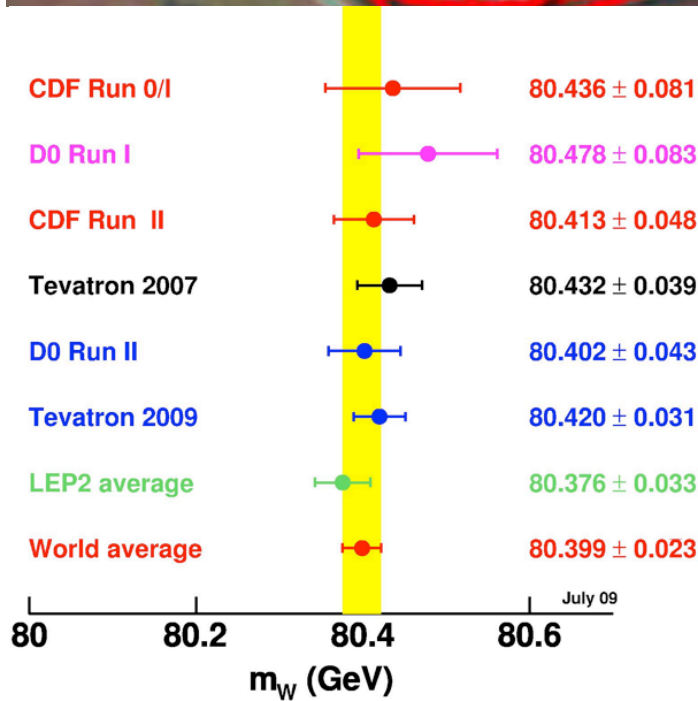

~18k events in 1 fb^{-1}

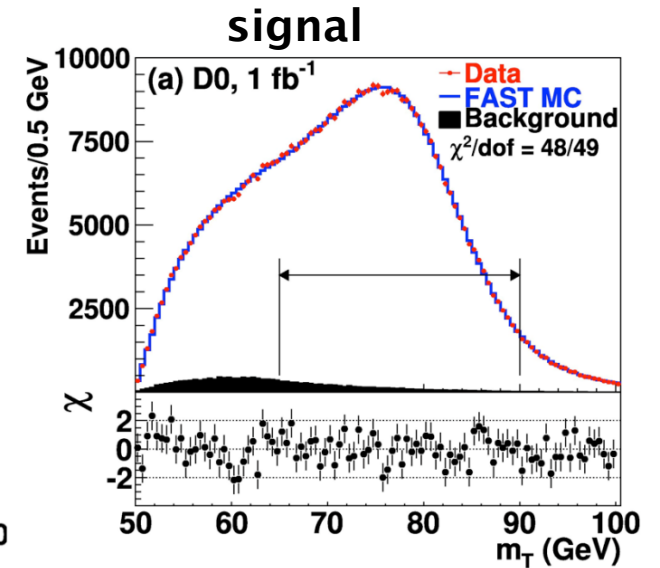

~485k events in 1 fb^{-1}

current Tevatron precision: **0.04%**

→ expect improvements (statistics + systematics) with larger data sets

Aim: 15MeV error

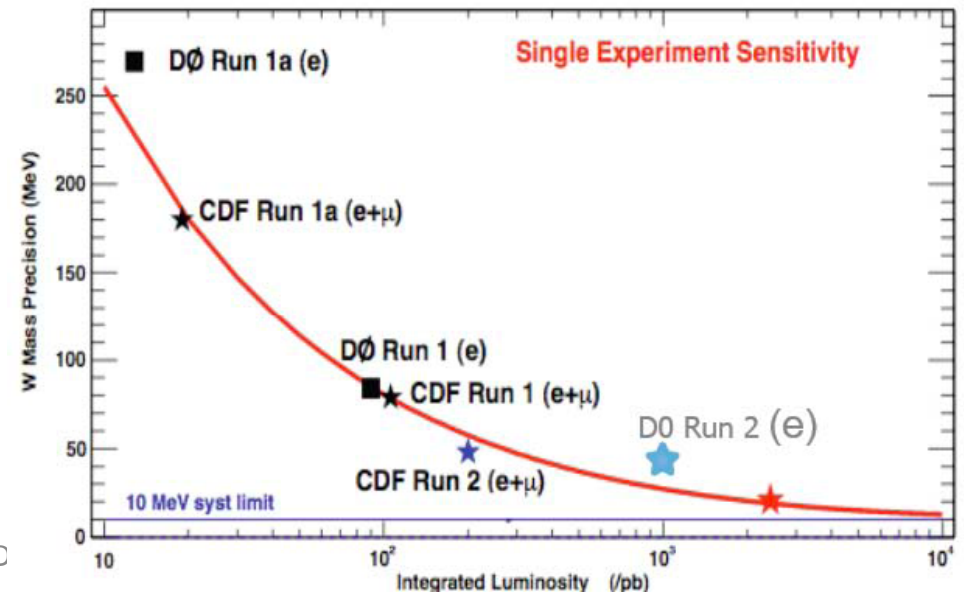

FUTURE LEGACY: TOP MASS

Mass of the Top Quark

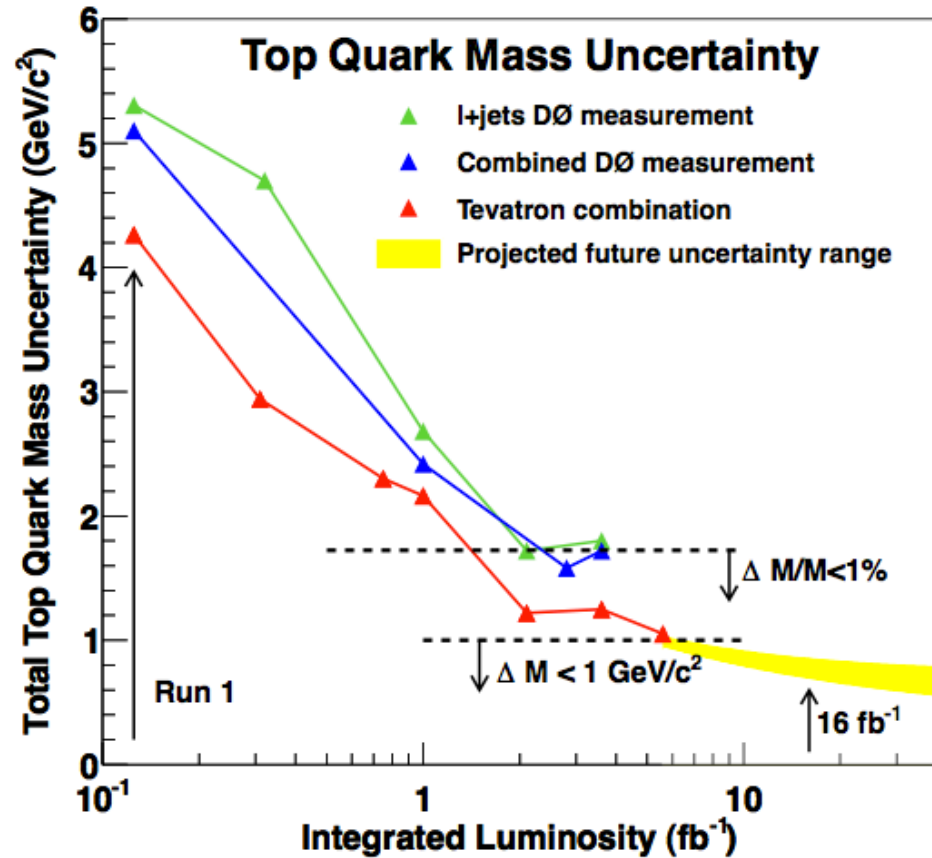
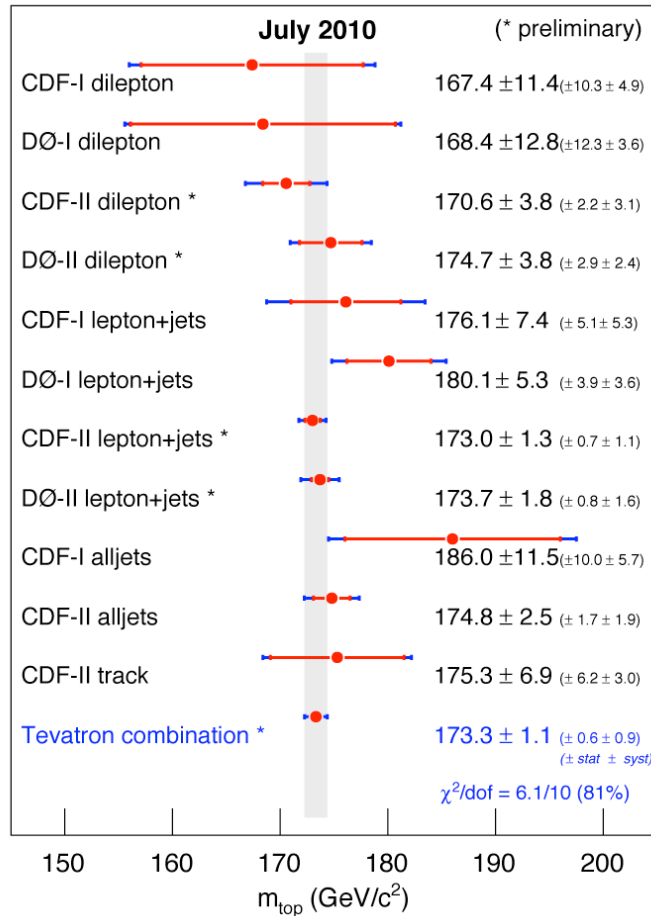

current Tevatron precision: 1.1 GeV \rightarrow 0.7%
Aim : better than 1 GeV

SELF-CONSISTENCY OF THE SM

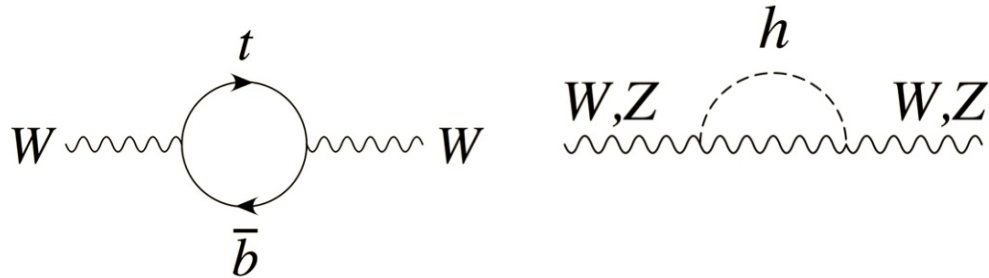

Current

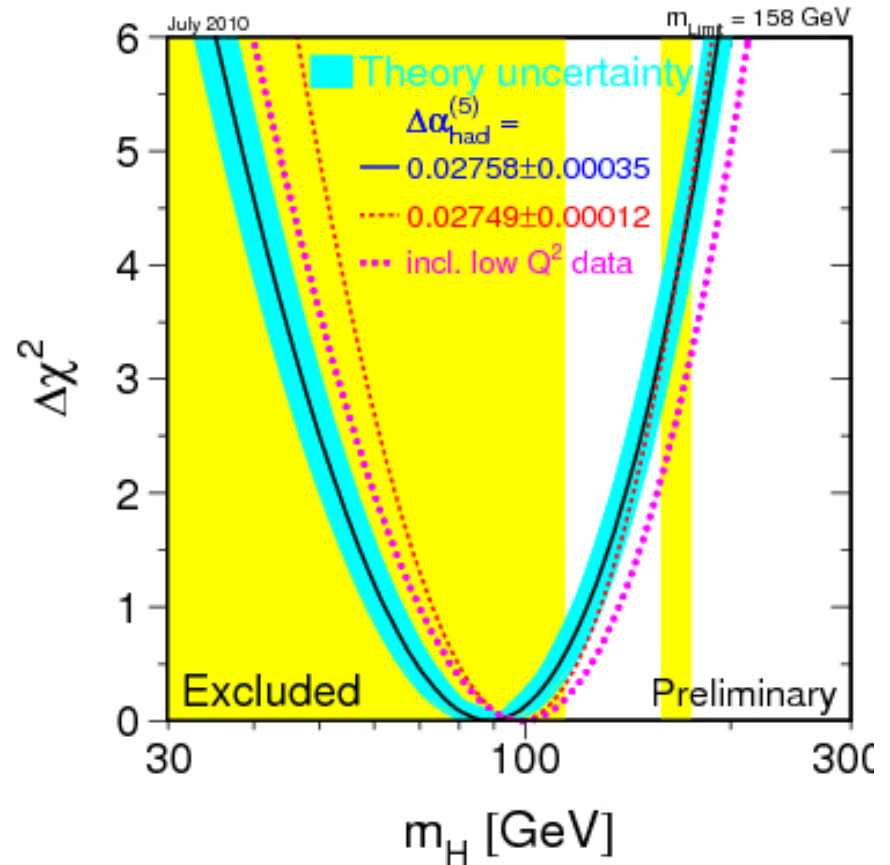
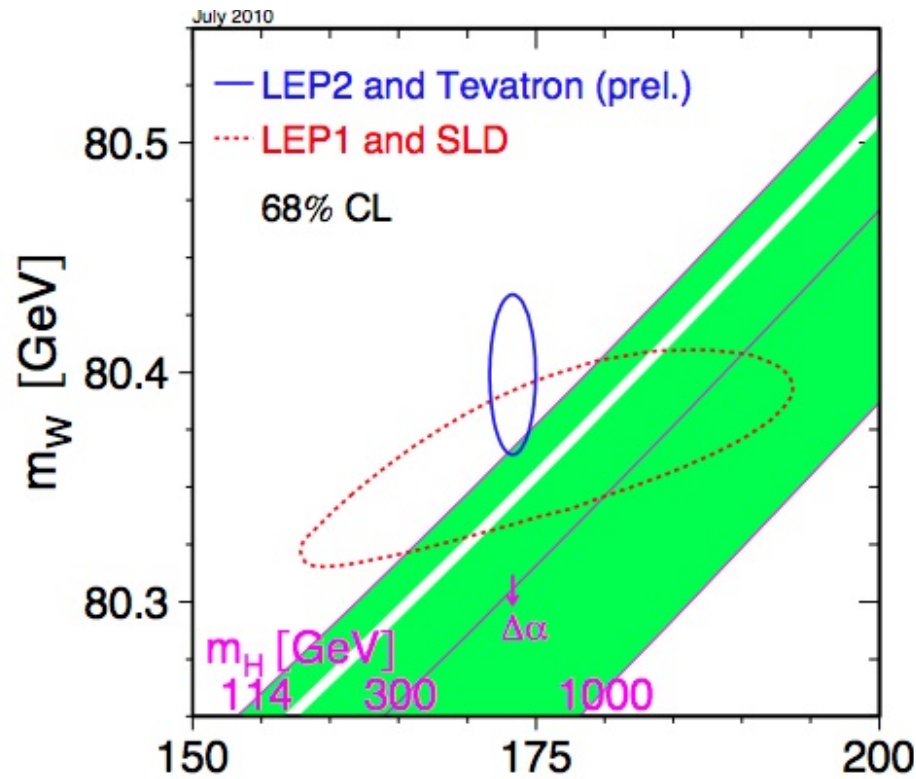

SELF-CONSISTENCY OF THE SM

Projections

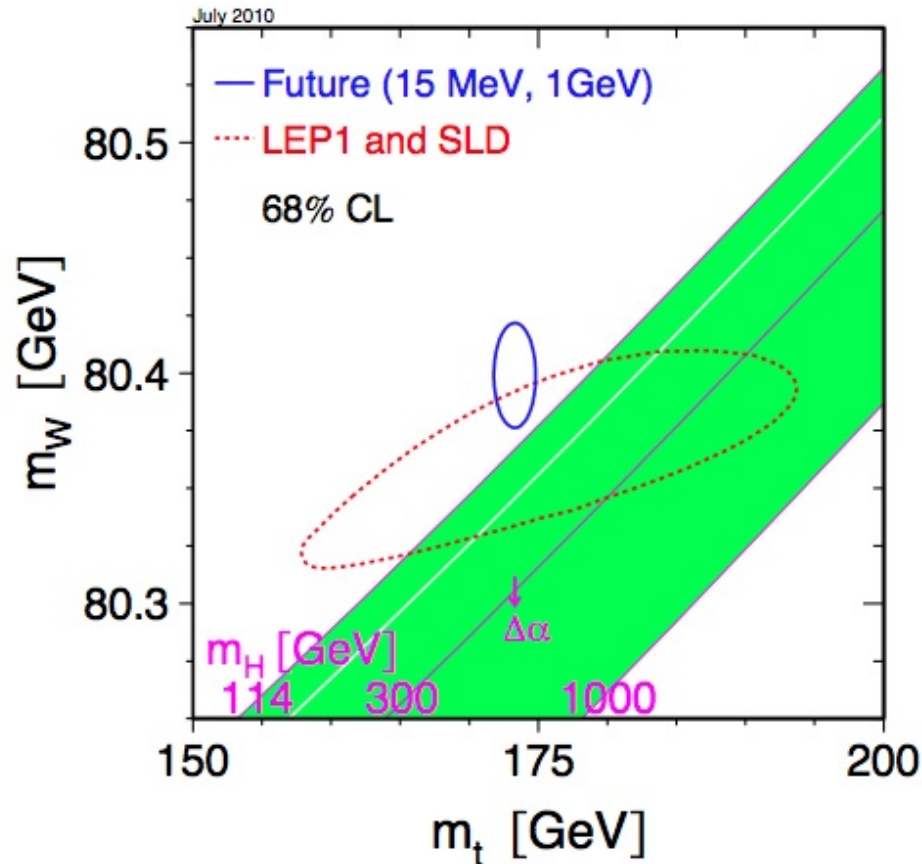

Improved W mass measurement is critical

Assume:

top mass uncertainty = 1 GeV
 W mass uncertainty = 15 MeV

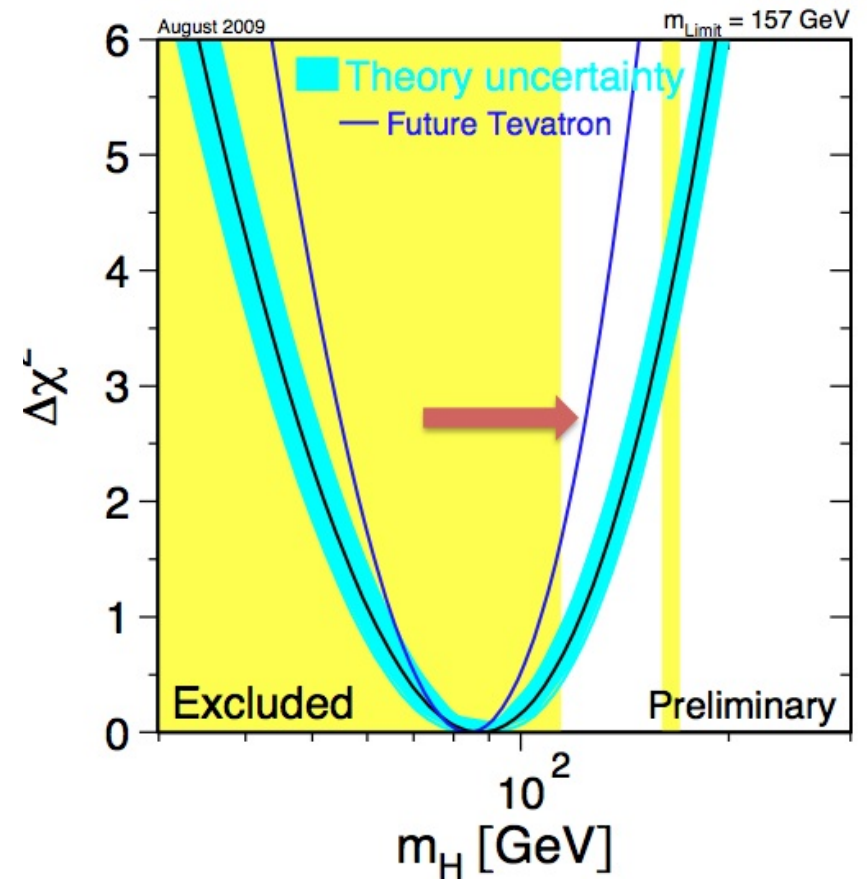

$m_H < 117$ GeV at 95% CL at
 current minimum

EVENT YIELDS: TEVATRON AND LHC

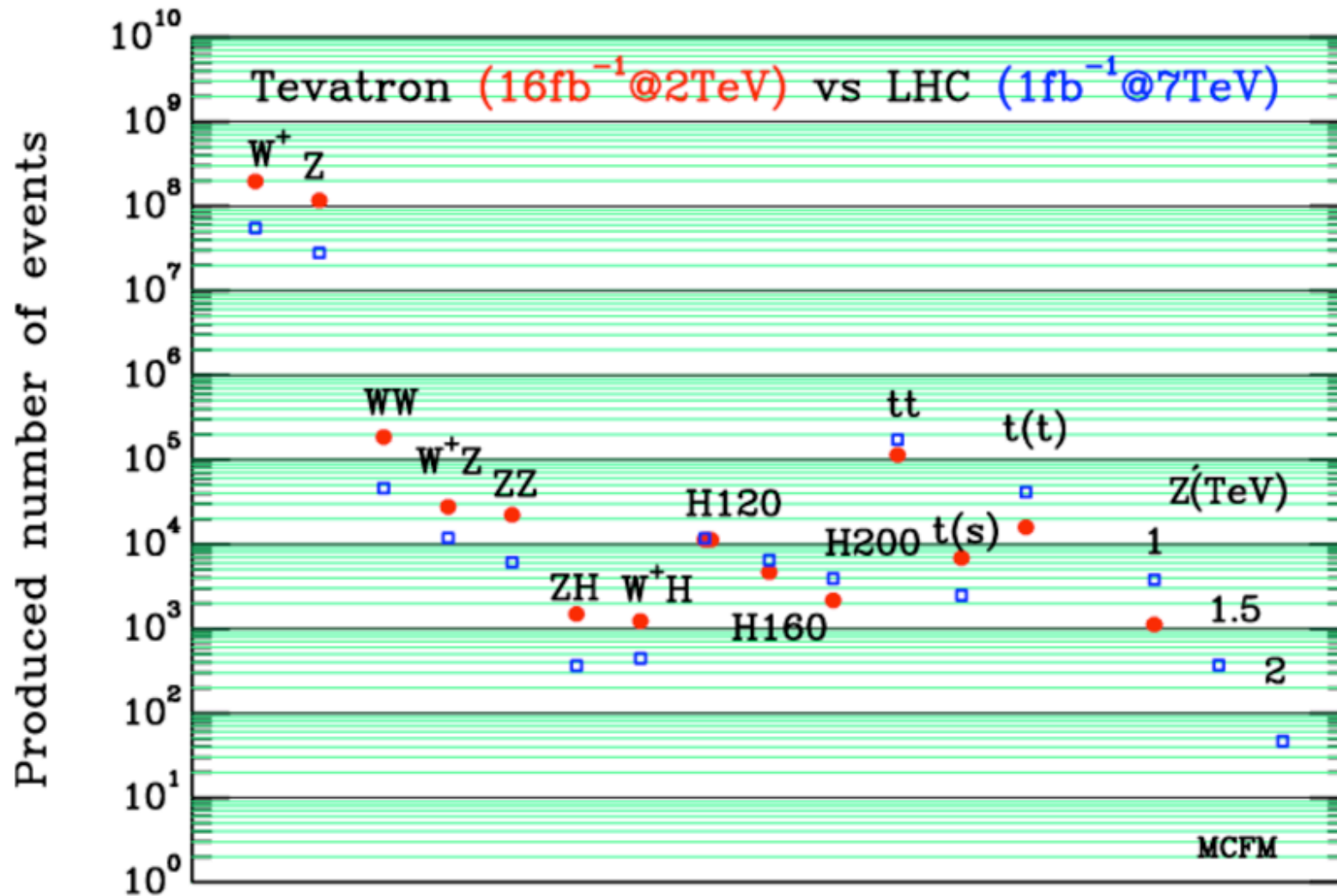

(Caution: compares 2014 Tevatron data set with 2012 LHC data set)

COMPLEMENTARY: HIGH-X GLUONS

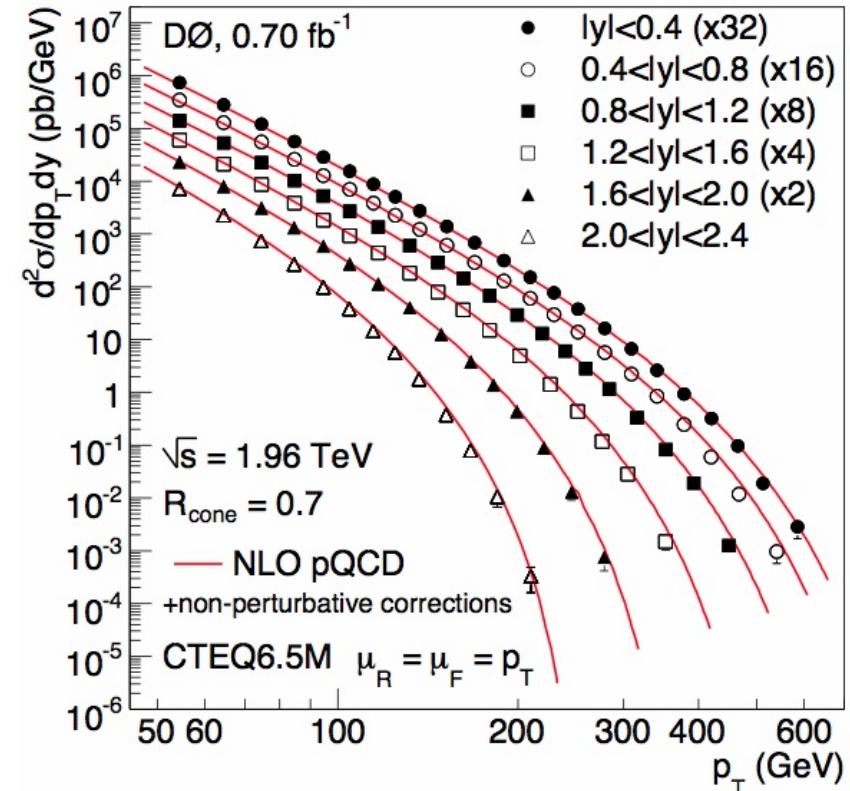
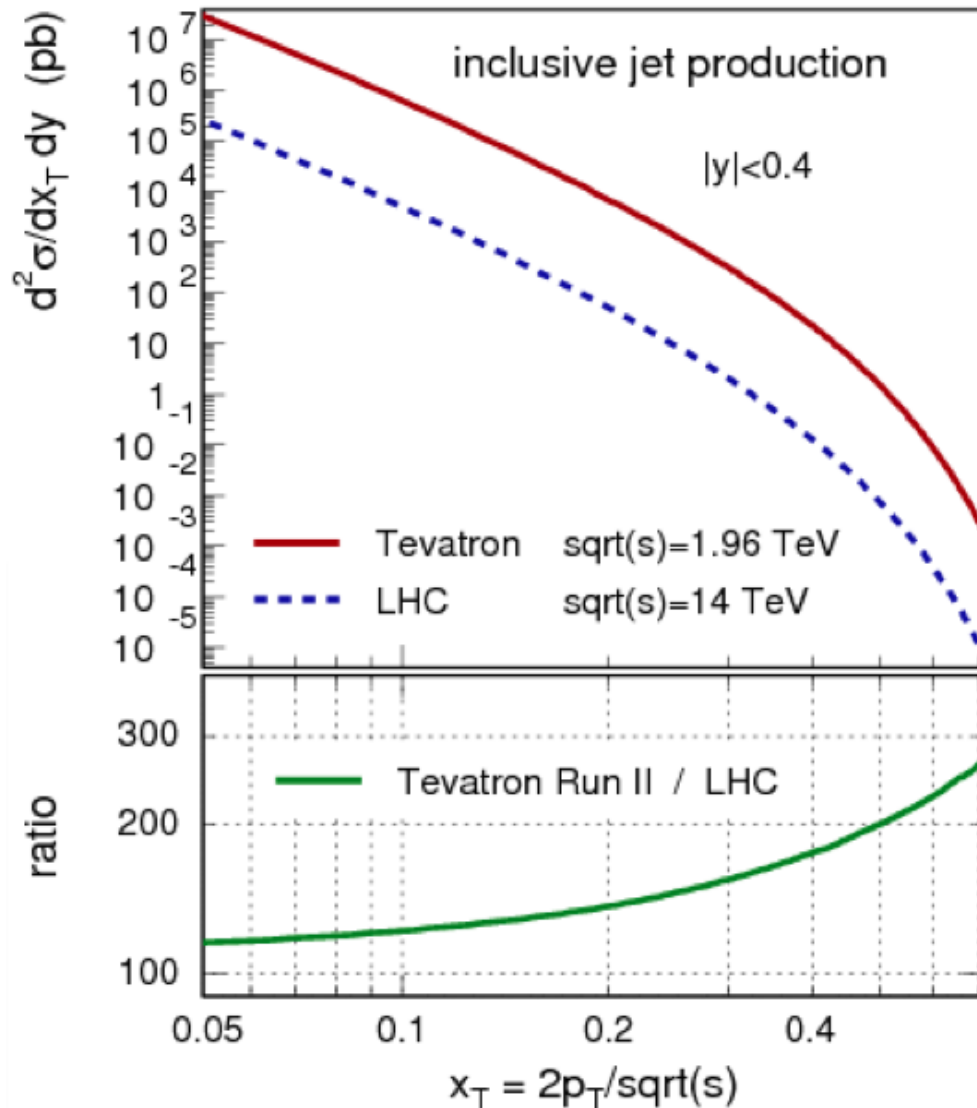

**gluon distribution at high $x_T > 0.5$:
LHC needs 200 times more
luminosity than Tevatron to reach
the same sensitivity on PDFs
measurement still statistically
limited**

COMPLEMENTARY: P-ANTI-P vs PP

Example: spin correlations in t-tbar production

Tevatron

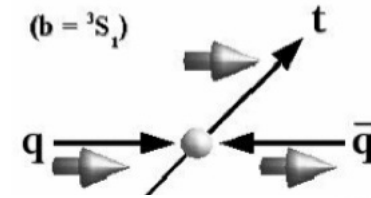

LHC

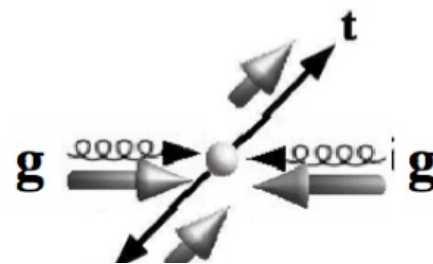

Now

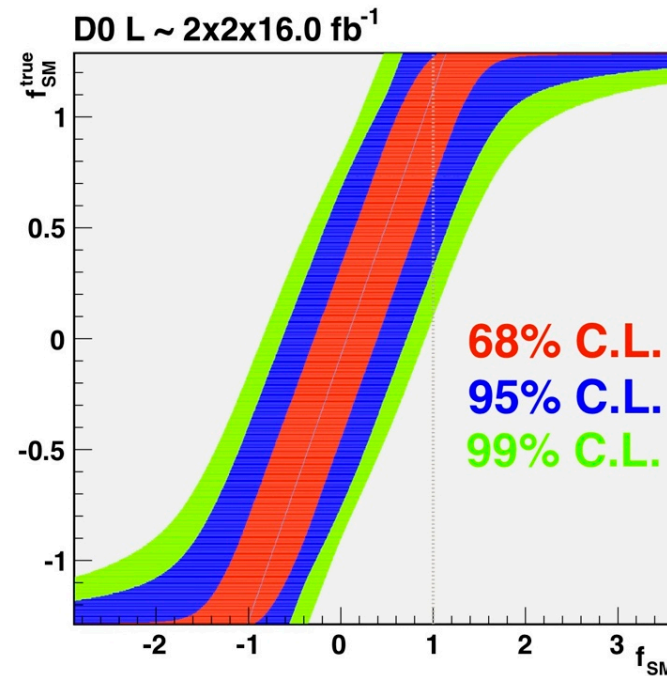
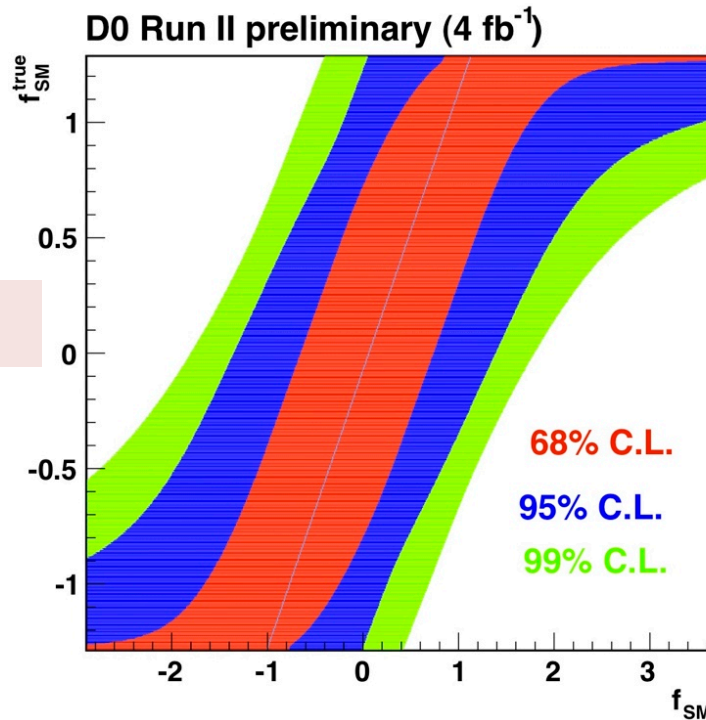

Projected sensitivity

LEGACY: SINGLE TOP (S-CHANNEL)

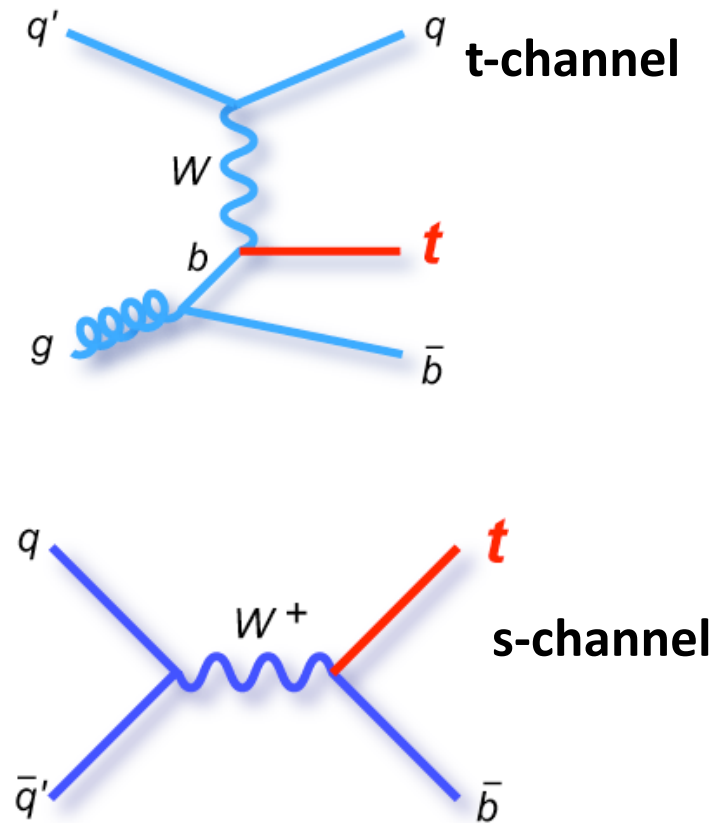
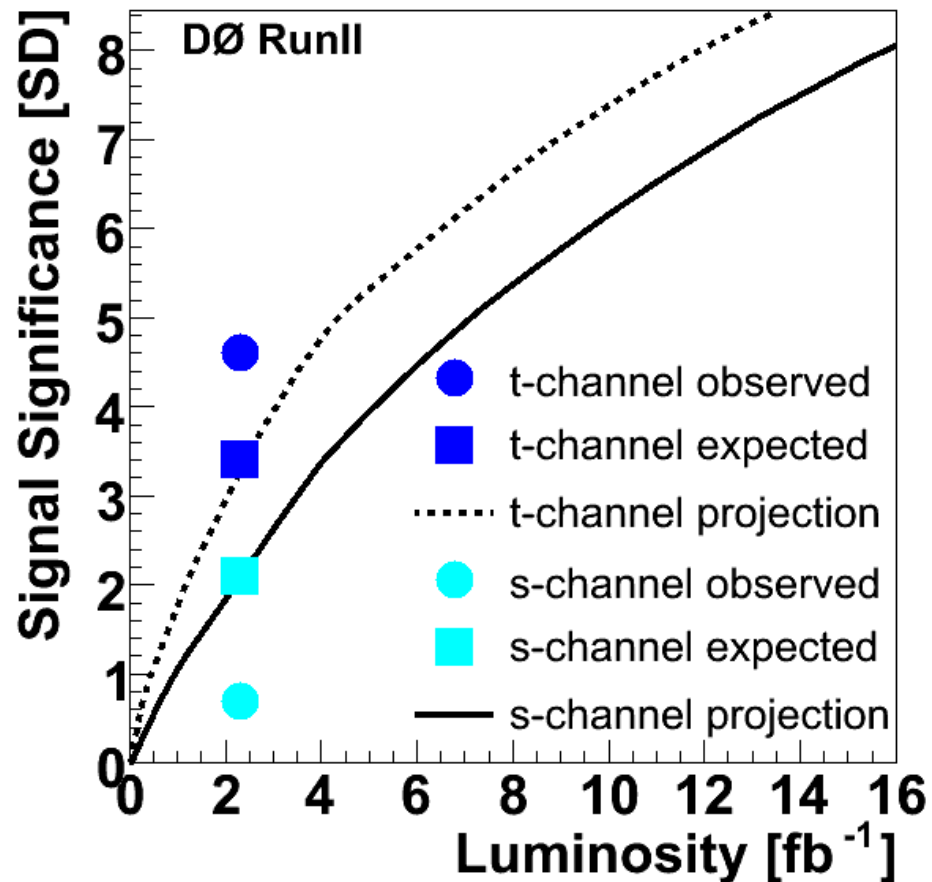

LHC estimation: 10-30 fb^{-1} at $\sqrt{s}=14$ TeV for 3-sigma excess in s-channel

HINTS AND EXCESSES: DIMUON ASYMMETRY

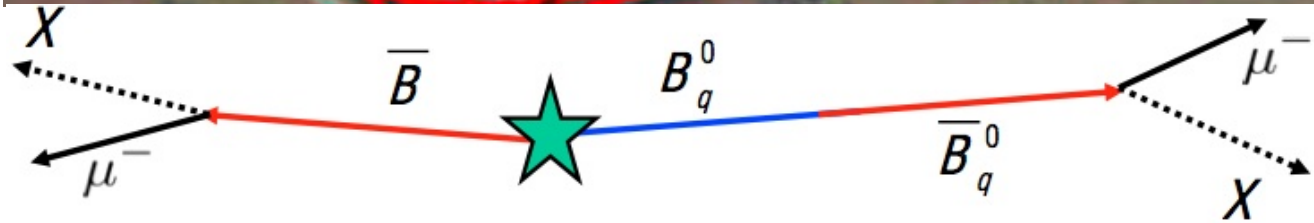

$$A_{sl}^b \equiv \frac{N_b^{++} - N_b^{--}}{N_b^{++} + N_b^{--}}$$

N_b^{++} (N_b^{--}) – number of same-sign $\mu^+\mu^+$ ($\mu^-\mu^-$) events from $B \rightarrow \mu X$ decay

$$a_{sl}^q \equiv \frac{\Gamma(\bar{B}_q^0 \rightarrow \mu^+ X) - \Gamma(B_q^0 \rightarrow \mu^- X)}{\Gamma(\bar{B}_q^0 \rightarrow \mu^+ X) + \Gamma(B_q^0 \rightarrow \mu^- X)}; \quad q = d, s$$

Given relative abundances of B_d and B_s , measured asymmetry A_{sl}^b gives linear combination of a_{sl}^b and a_{sl}^d

3.2 σ deviation from SM

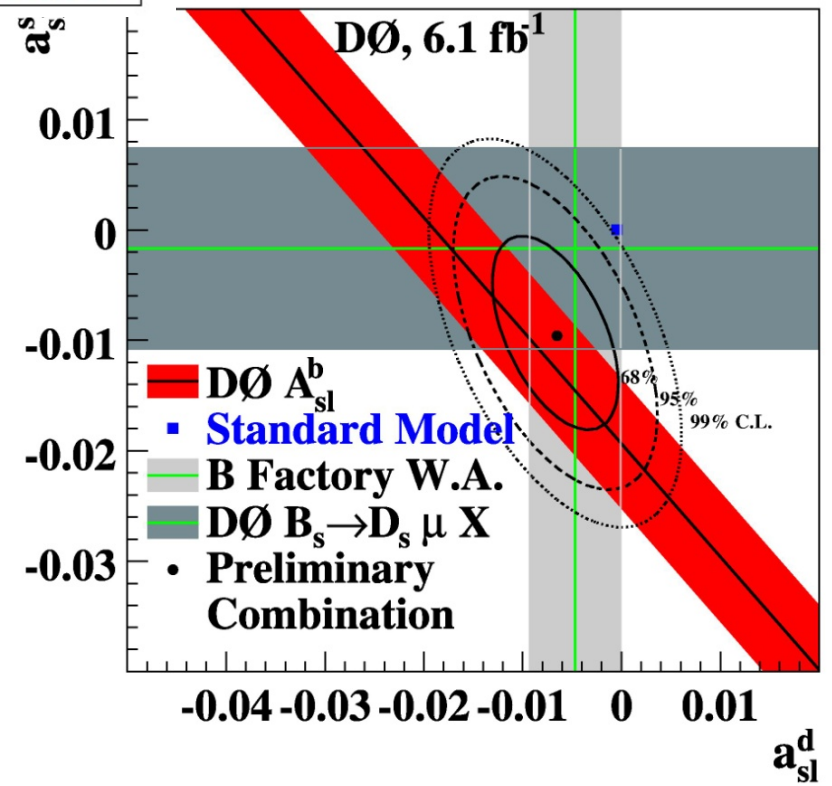

COMPLEMENTARITY : DIMUON ASYMMETRY

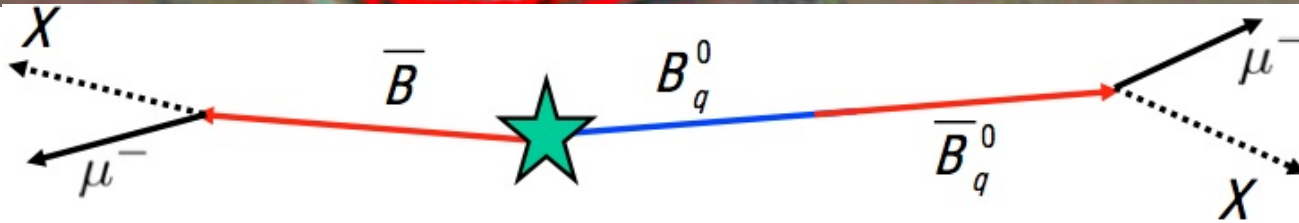

$$A_{sl}^b \equiv \frac{N_b^{++} - N_b^{--}}{N_b^{++} + N_b^{--}}$$

N_b^{++} (N_b^{--}) – number of same-sign $\mu^+\mu^+$ ($\mu^-\mu^-$) events from $B \rightarrow \mu \nu$

$$a_{sl}^q \equiv \frac{\Gamma(\bar{B}_q^0 \rightarrow \mu^+ X) - \Gamma(B_q^0 \rightarrow \mu^- X)}{\Gamma(\bar{B}_q^0 \rightarrow \mu^+ X) + \Gamma(B_q^0 \rightarrow \mu^- X)}; \quad q = d, s$$

Given relative abundances of B_d and B_s , measured asymmetry A_{sl}^b gives linear combination of a_{sl}^b and a_{sl}^d

3.2 σ deviation from SM

**semileptonic decays:
 $B_{s,d} \rightarrow D \mu \nu$ at the LHCb**

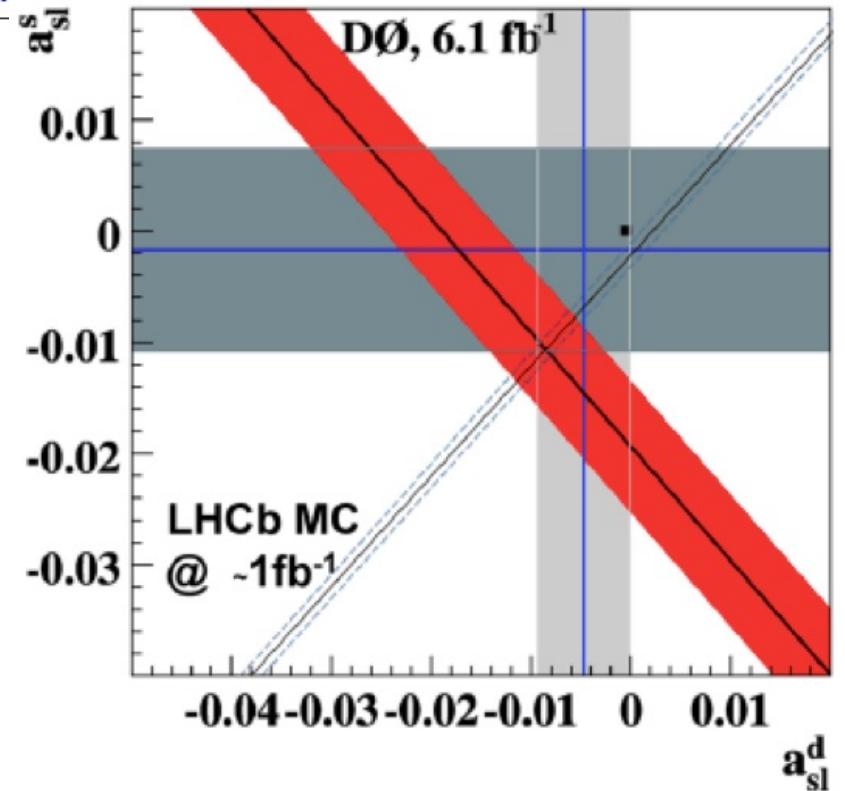

SUMMARY

- Tevatron accelerator and the CDF and Dzero detectors are prepared to take advantage of a unique opportunity in the next few years

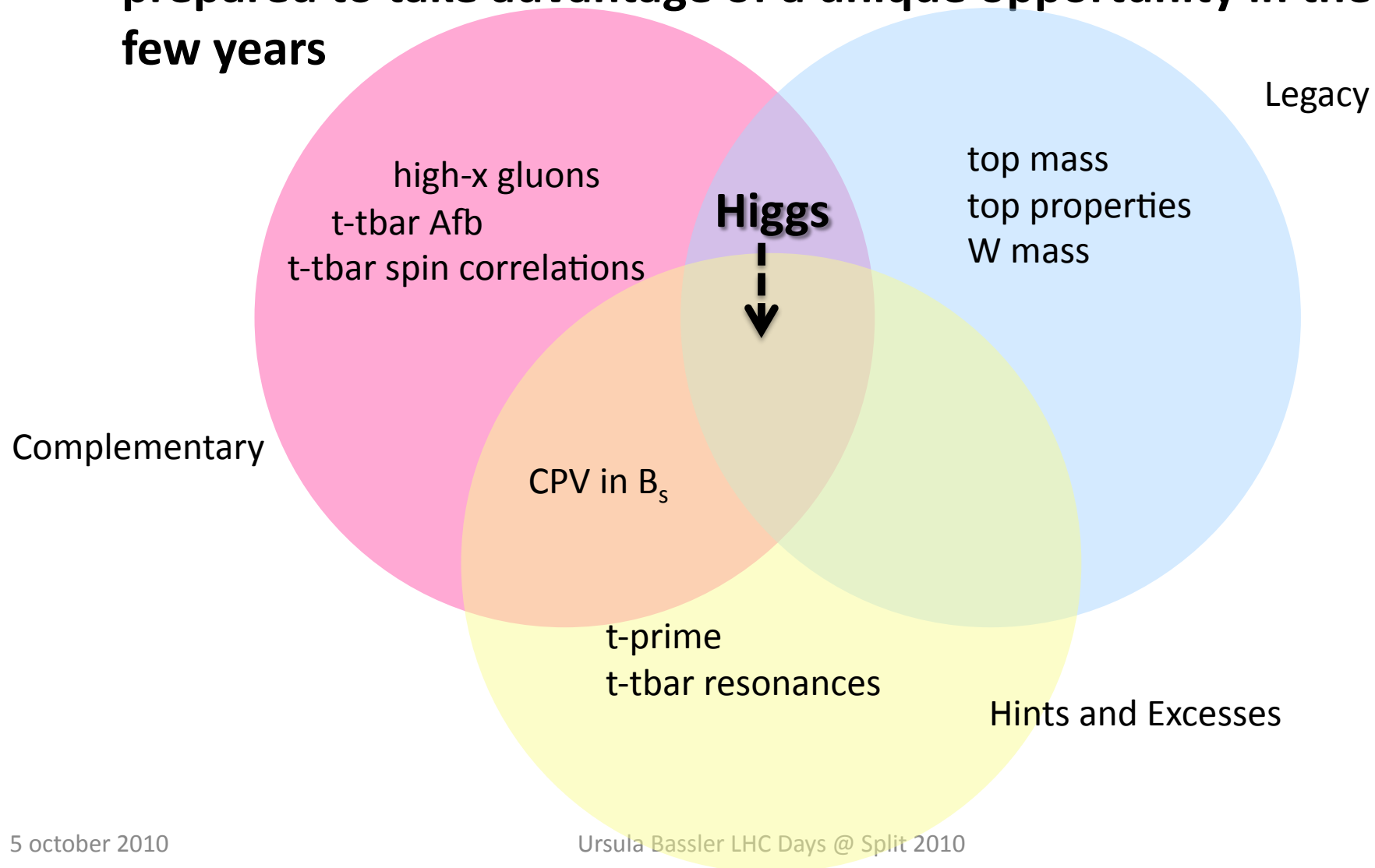



HISTORY

- **February 2010** : first thoughts in the experiments for running beyond 2011
- **June 2010 Fermilab PAC meeting**
 - CDF and DZero proposed 3 years Tevatron Run extension
 - Many questions asked to the “Beyond 2011” task force
- **August 2010 special PAC meeting**
 - Answers to all PAC questions provided
 - Excellent progress by “Beyond 2011” task force
 - ➔ Tevatron experiments should be able to collect and analyze data efficiently!
 - Very strong support of the extension by the PAC

Recommendation

The Committee strongly endorses the extension of the Tevatron run for three years during 2011–2014 under either funding scenario presented in the charge. The Committee is aware that the development of the future programs might be severely affected and projects delayed by the Collider run. The Committee recommends that efforts be made to mitigate the effects. While the Tevatron run extension would take advantage of a compelling opportunity, the long-term plans of the Laboratory and of the field, as outlined by the P5 report, should be pursued vigorously.



STATUS

- **Extension of the Tevatron run has strong support**
 - PAC recommendation
 - Letters to DOE and Fermilab director
 - Support from physicists and funding agencies around the world
 - The Fermilab is now actively pursuing this option
- **There are many steps still ahead before approval**
 - P5 and HEPAP meetings in october
 - Budget decisions for 2012

**We are delighted about the success of the LHC taking over physics
at the high energy frontier**

We want to achieve the best possible Tevatron legacy !

**We are motivated to make progress in the best possible ways for
our field!**