

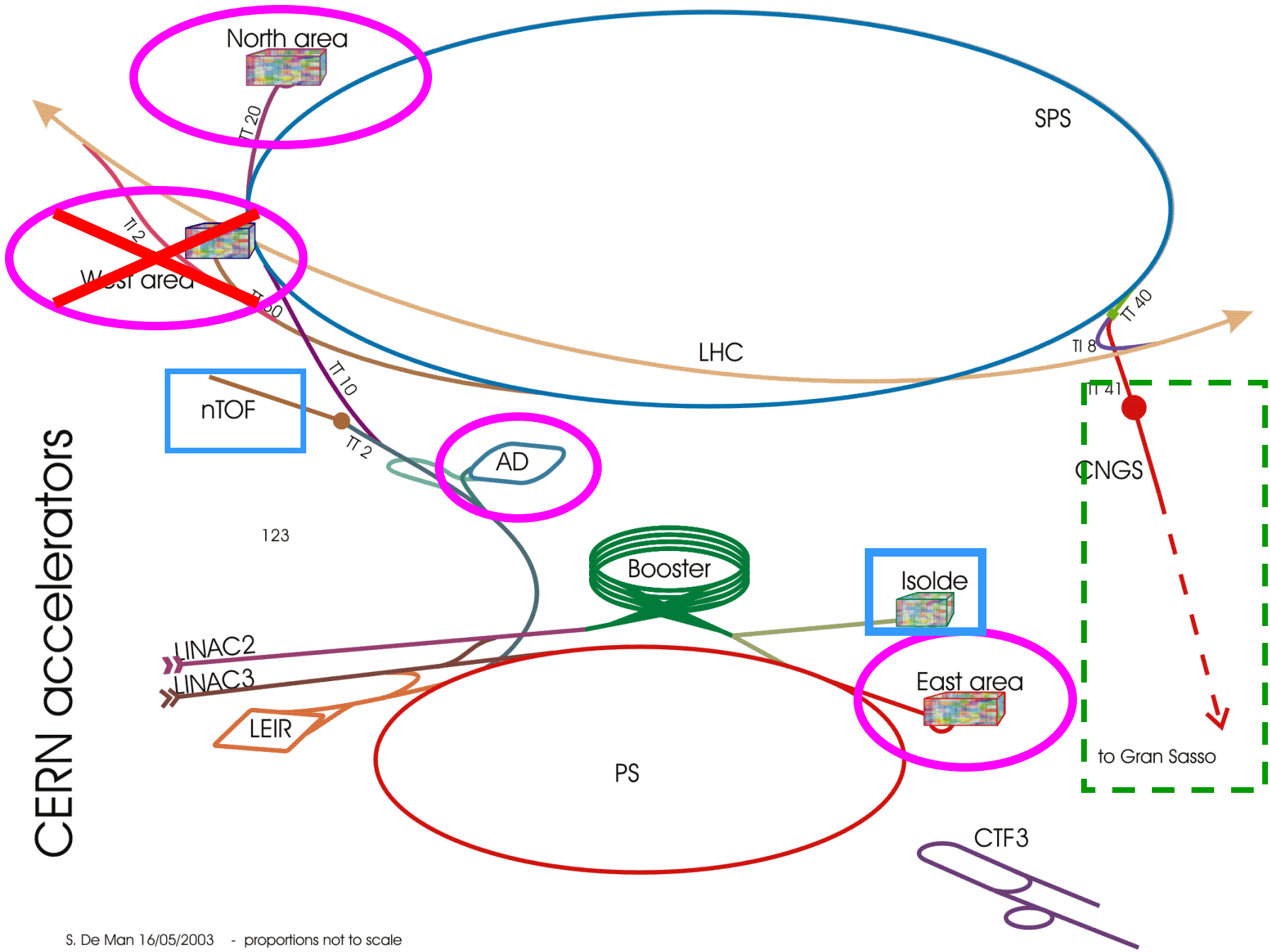

# The possible future of the experimental areas

L.Gatignon / CERN-AB-ATB







S. De Man 16/05/2003 - proportions not to scale

22 September 2004

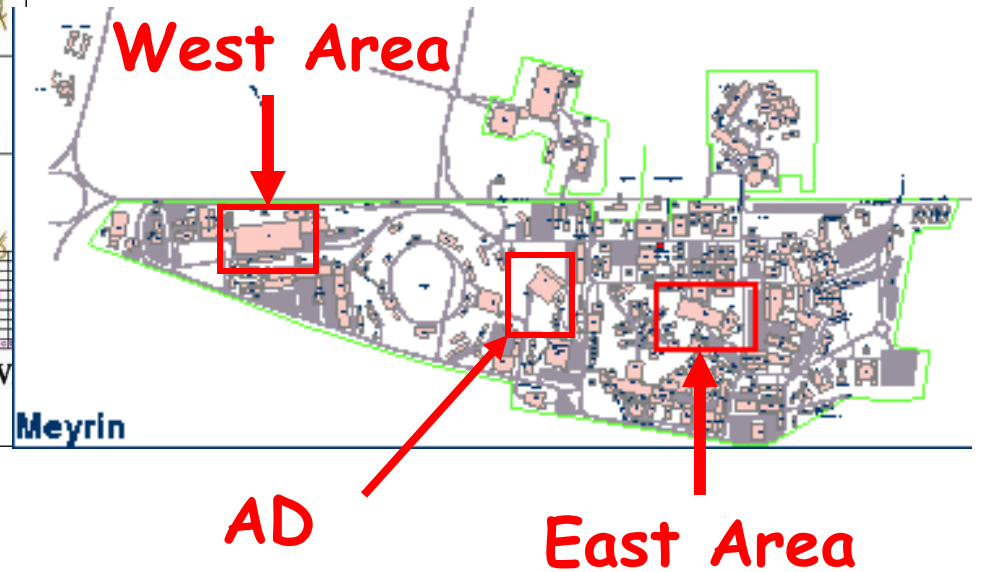
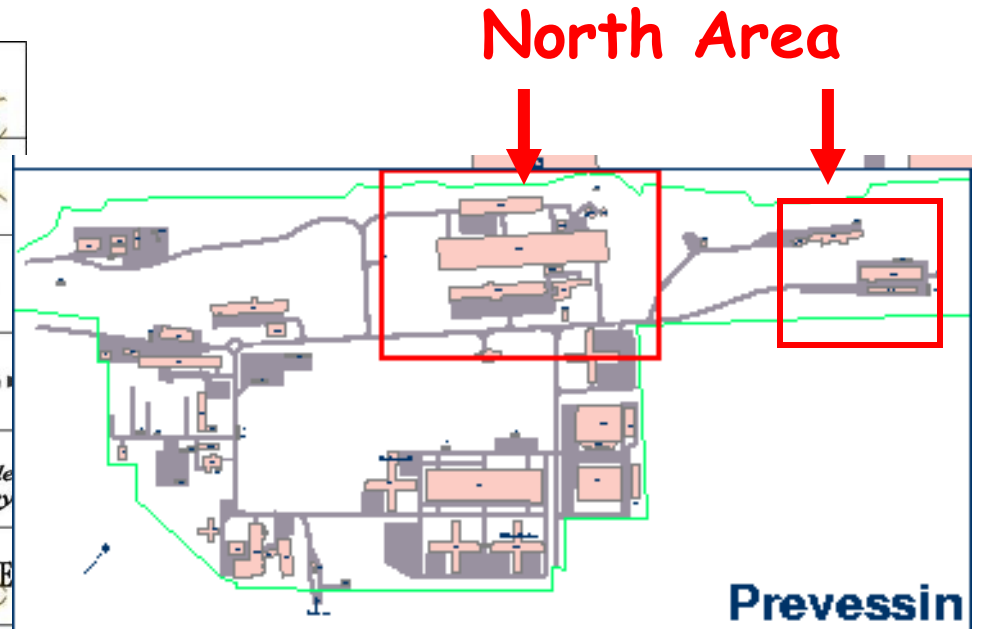
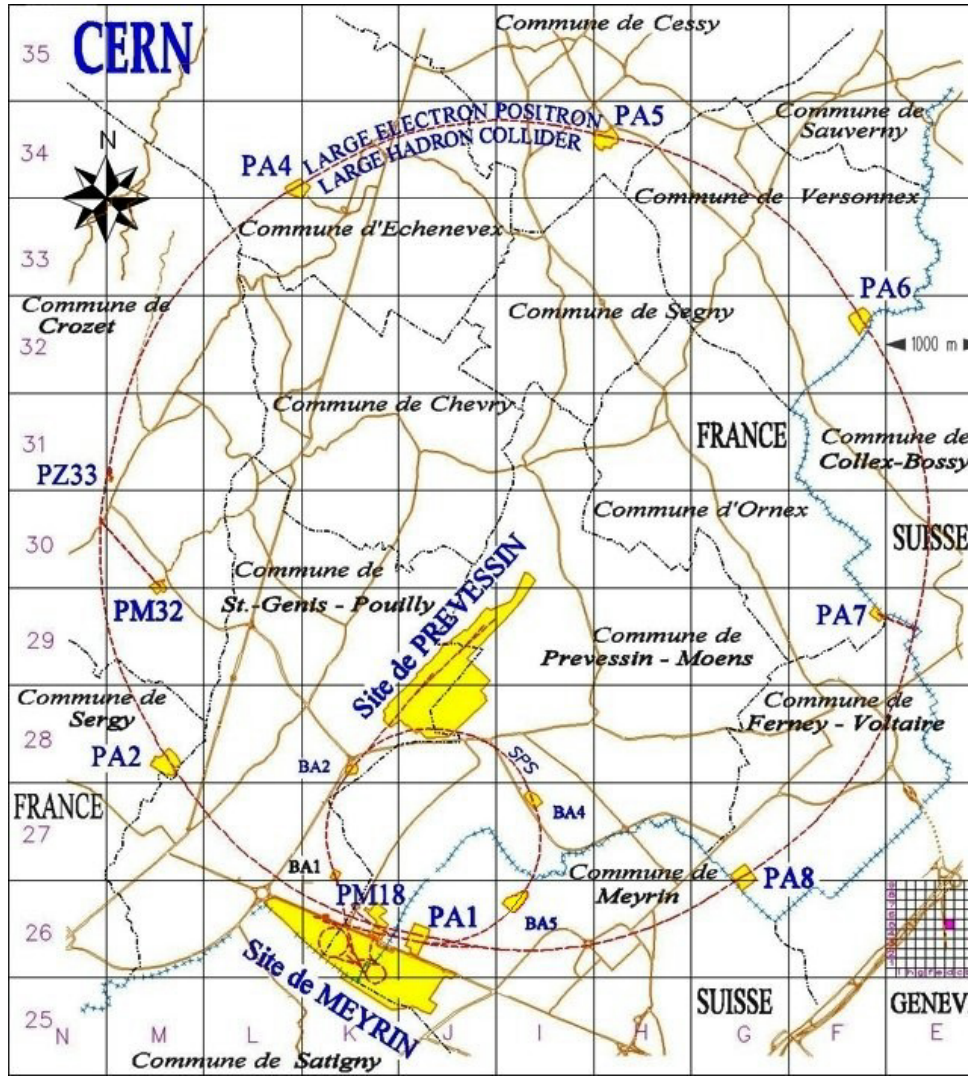
Possible future of experimental areas  
Villars Meeting of SPSC

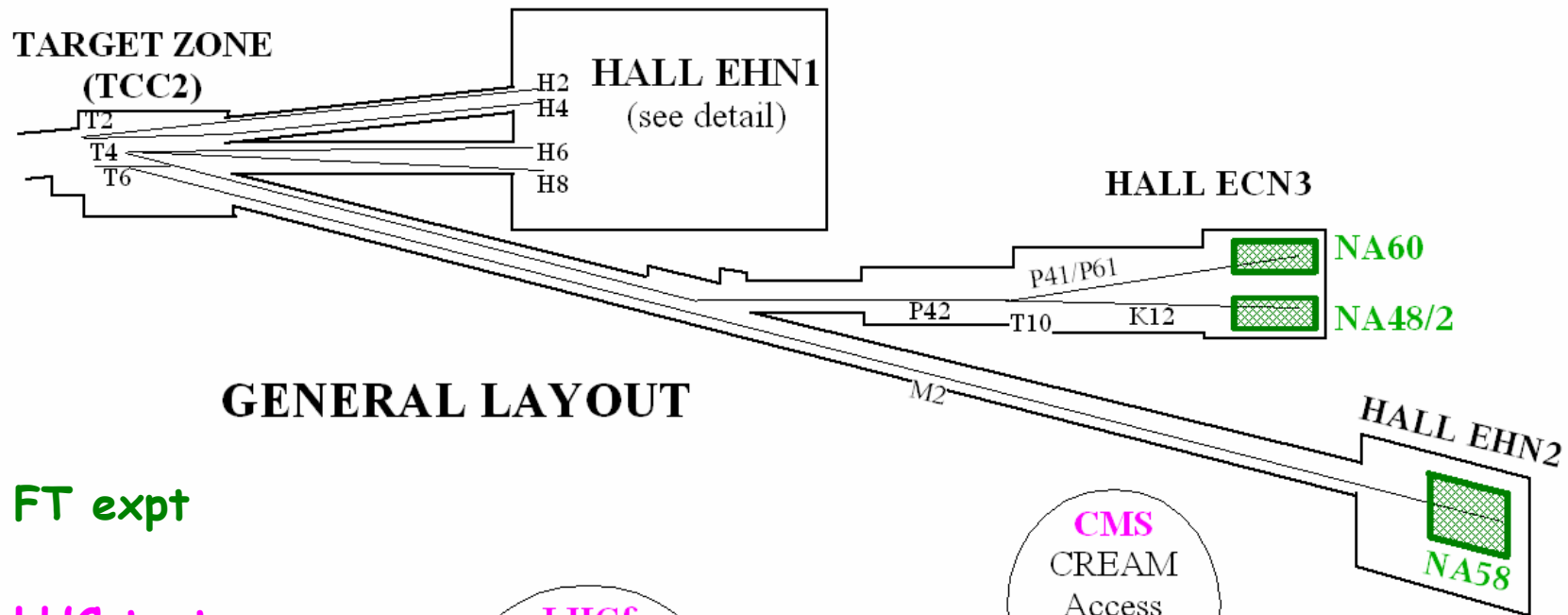



-  FT expt
-  LHC test

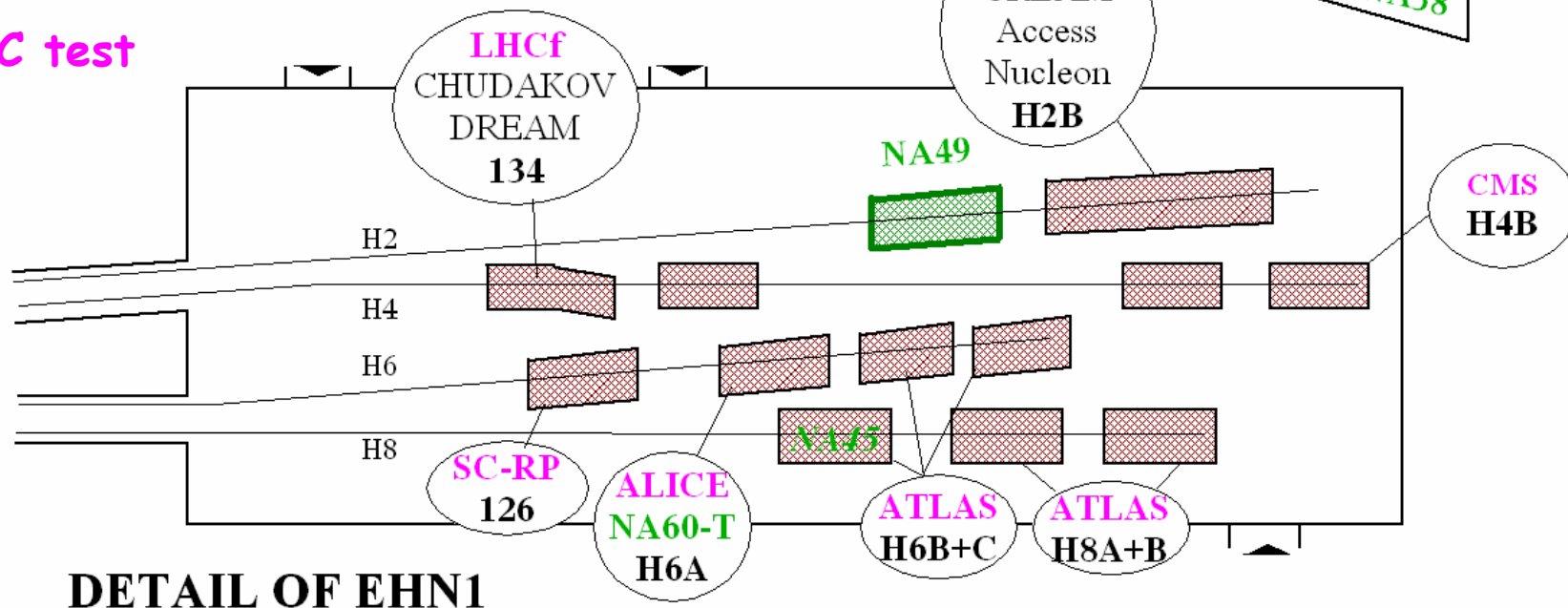

**SPS NORTH EXPERIMENTAL AREA** (Situation for 2004)

# The EHN1 beam lines

The H2, H4 and H8 beam lines in EHN1 were designed originally as high quality beam lines for physics experiments.

A large number of experiments have taken place in this hall, Among the more 'recent' ones are

- NA35, NA36, NA43, EHS in the H2 beam
- NA31 in H4
- NA12, NA34 (HELIOS) in H8

At the moment only NA49 is still installed in H2.

NA45 (CERES) in the H8 line is being dismantled.

All these beam lines can be operated as primary (proton or ion) beams or as secondary and tertiary hadron,  $e^\pm$  or  $\mu^\pm$  beams from 10 to 400 GeV/c. For the moment H2 is mainly used for CMS tests and outside test users, whereas H8 served recently almost exclusively for Atlas calibrations & tests.

The H6 beam line has been added a posteriori as a lower energy test beam. It is limited to 205 GeV/c and is extensively used by Atlas. It has served NA52 (particle production) and NA56 ("strangelets").

## Performance of the EHN1 beams

Beam Line	$p_{\max}$ (GeV/c)	Intensity/pulse for $10^{12}$ ppp incident	Beam type
H2	400	$9 \cdot 10^7 \pi^+$ at 200 GeV/c $3 \cdot 10^7 \pi^-$ at 200 GeV/c $4 \cdot 10^6 e^\pm$ at 150 GeV/c $1 \cdot 10^5 \text{Pb}$ at 400 GeV/Z	High-energy hadron or electron beam for physics or tests *)  Heavy ion beam
H4	450	$9 \cdot 10^7 \pi^+$ at 200 GeV/c $3 \cdot 10^7 \pi^-$ at 200 GeV/c $4 \cdot 10^6 e^\pm$ at 150 GeV/c $1 \cdot 10^7 \text{p}$ at 450 GeV/c $1 \cdot 10^5 \text{Pb}$ at 400 GeV/Z	High-energy hadron or electron beam for physics or tests,  Att. proton beam  Heavy ion beam
H6	205	$1 \cdot 10^8 \pi^+$ at 150 GeV/c $4 \cdot 10^7 \pi^-$ at 150 GeV/c	Medium energy hadron beam, also for tertiary test beams
H8	450	$1 \cdot 10^7 \text{p}$ at 450 GeV/c $2 \cdot 10^8 \pi^+$ at 200 GeV/c $7 \cdot 10^7 \pi^-$ at 200 GeV/c $1 \cdot 10^6 \text{Pb}$ at 400 GeV/Z	Att. proton beam High-energy hadron or electron beam for physics or tests, *) Heavy ion beam

*\*) Recently Very Low Energy options were added for tests:  $\geq 1$  GeV/c(H8),  $\geq 2$  GeV/c (H2)*

# Operational constraints

1. The intensity of the beam lines is not only limited by technical and physics constraints, but also by **radioprotection limits**.
2. Often **fixed dumps** separate the different zones along a beam. Their replacement by mobile dumps (recuperable from the West Area) should be considered.
3. The H2 and H4 lines are coupled by the so-called T2 **wobbling station**. The same is true (and even more restrictive) for the 3 beams originating from the T4 target station: H6, H8 and P0. Alternatively the P0 beam may be derived from the T6 target, **This normally imposes scheduling restrictions**.

# T2 Wobbling

The T2 wobbling serves only two beam lines and is relatively free.  
Some examples:

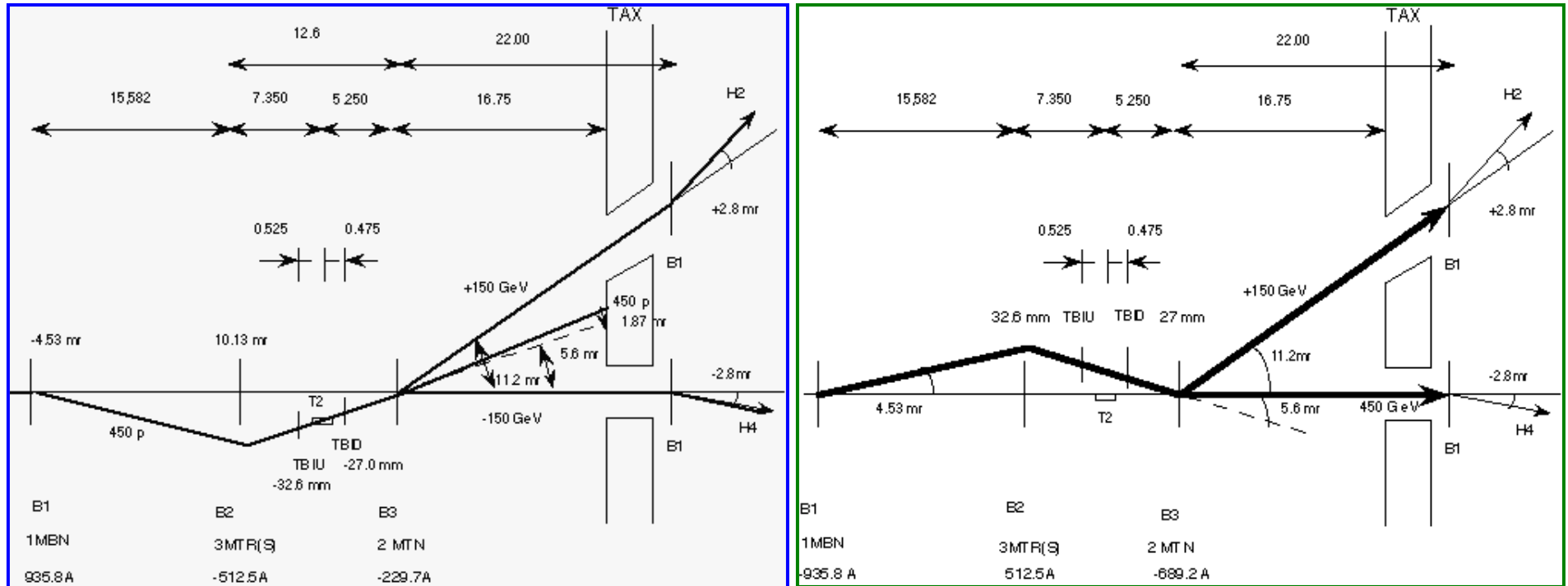

H2 at +150 GeV/c  
 H4 at -150 GeV/c  
 or  $e^\pm$  in either beam @ 4.52 mrad

H4 protons at 450 GeV/c  
 H2 at +150 GeV @ 0 mrad



# Example:

## THE T4 TARGET STATION

P0 electrons, H8 +180 GeV, H6 120 GeV @ 3.754 mrad  
or 95.3 GeV @ 0 mrad

Note: 3 beams !

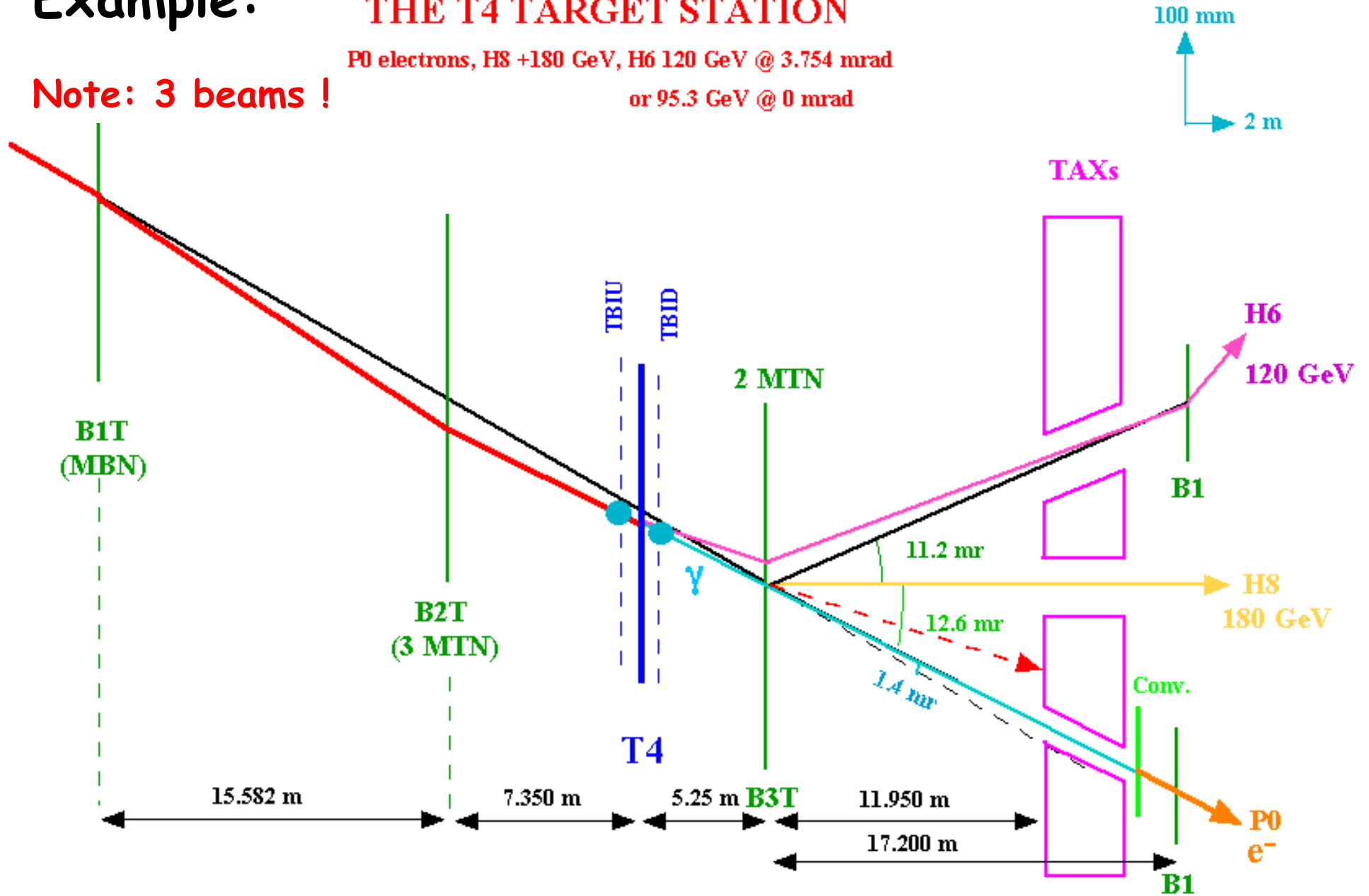

22 September 2004

Possible future of experimental areas  
Villars Meeting of SPSC

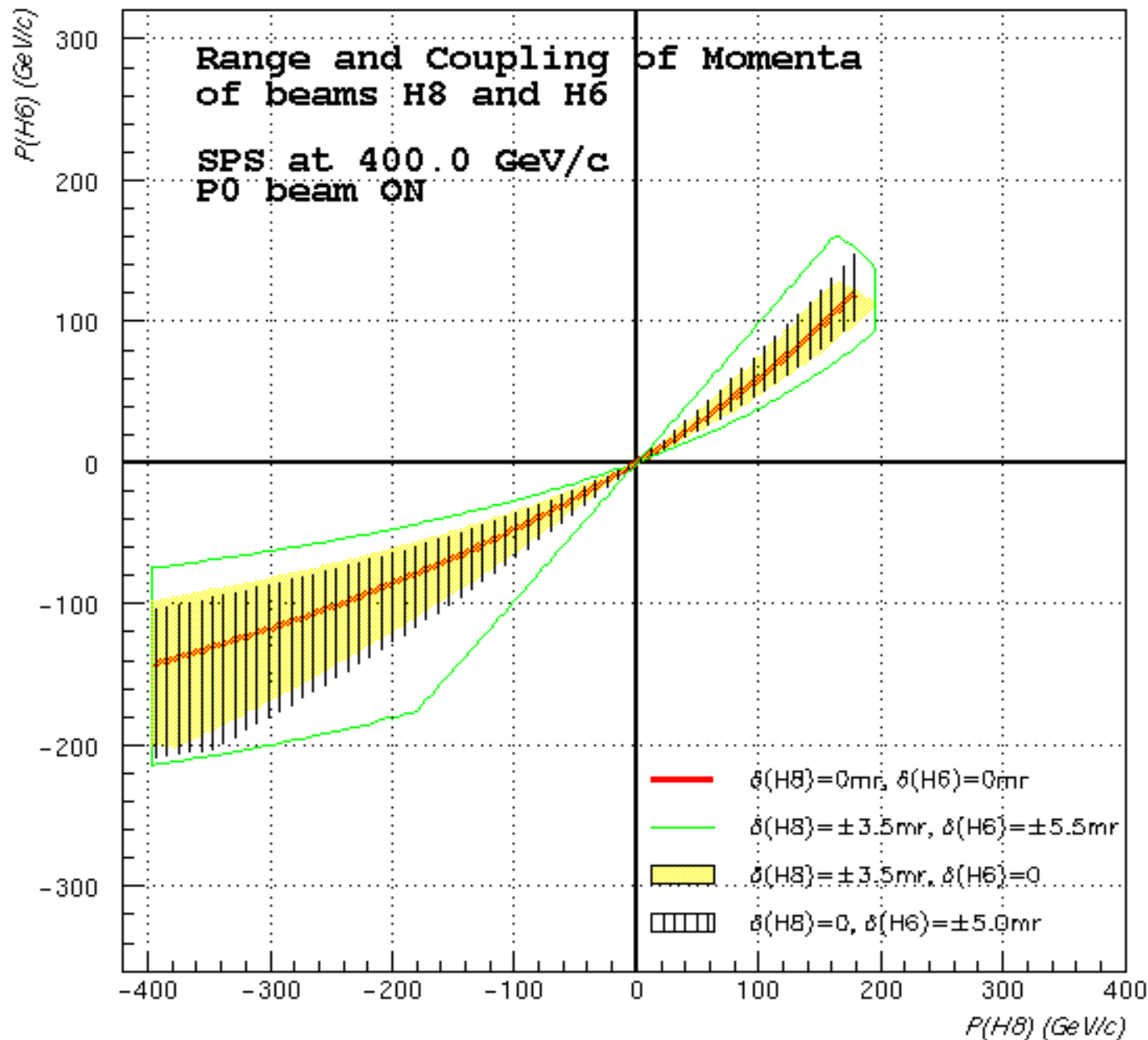

**Much more  
constrained  
than T2 !**

**There is more  
freedom when  
P0 is switched off  
or derived from  
the T6 target**

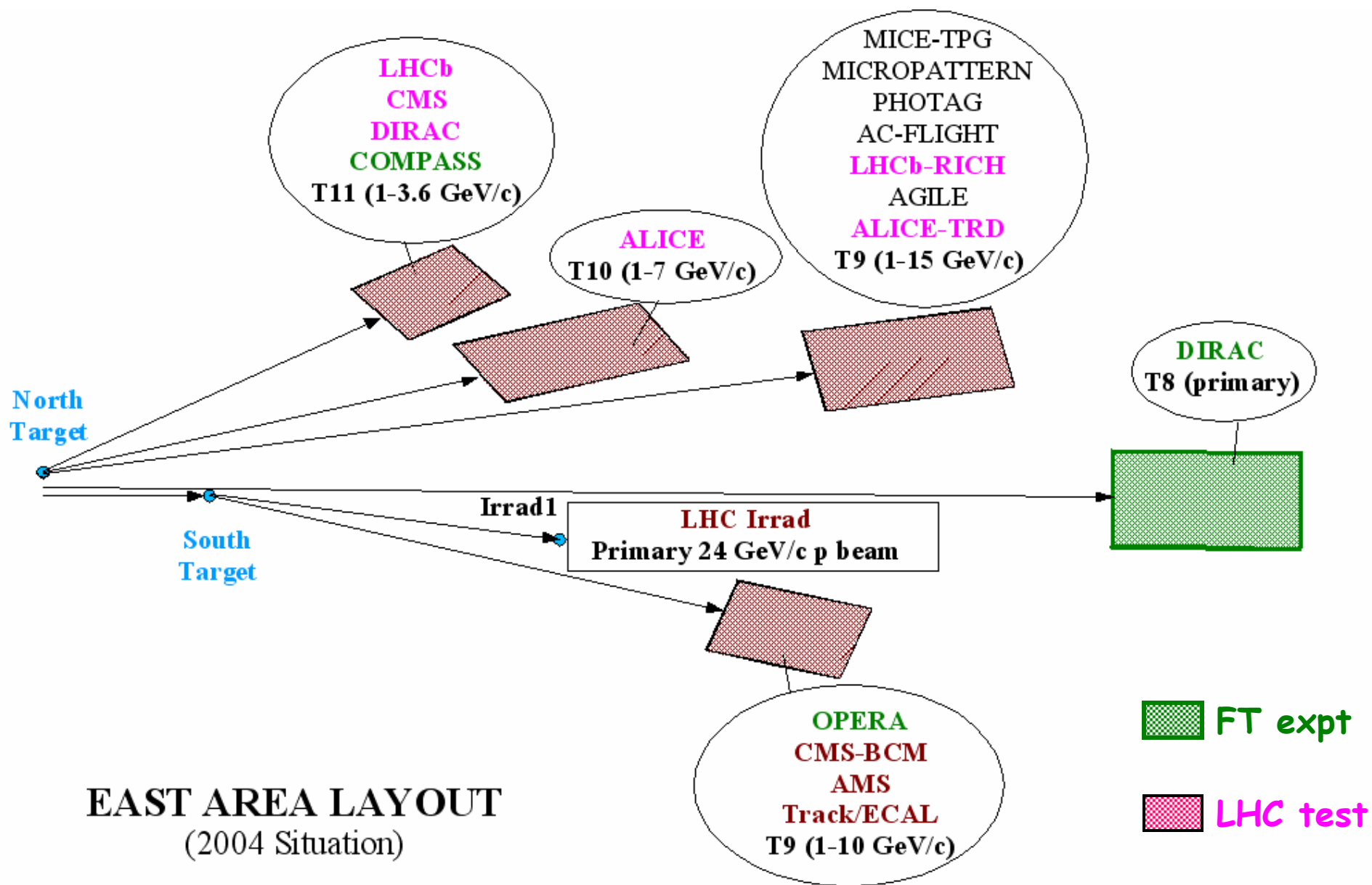

# Properties of East Area lines

The T8 beam line served the DIRAC experiment. Dirac requests only minor modifications to the beam line and continues with the 24 GeV/c primary proton beam (if approved).

The T9 beam line has served HARP.

The T7, T9, T10 and T11 beams have been designed as secondary test beams for small to medium size setups. For the moment they serve mainly IRRAD, LHCb and Alice and a large number of smaller test users. After the closure of the West Area, a number of teams expect to migrate to the East Area, in particular Alice and part of LHCb.

The number of PS cycles for the East Area has to be negotiated with respect to those attributed to Isolde and nTOF in particular.

Line	Momentum range	Momentum resolution	Particles	Nominal Intensity (*)	Intensity range (relative)	Remarks
T7	1-10 GeV/c ( $\pm$ )	0.4%	mixed	$0.3-1.0 \cdot 10^6$	$\sim 1.0 \cdot 10^{-3}-5$	
T8	24 GeV/c	0.015%	protons	$5-20 \cdot 10^{10}$	from MCR	primary
T9	1-15 GeV/c ( $\pm$ )	0.6%	mixed	$0.3-1.0 \cdot 10^6$	$\sim 0.02-6$	
T10	1-7 GeV/c ( $\pm$ )	0.5%	mixed	$0.3-1.0 \cdot 10^6$	$\sim 0.02-4$	
T11	1-3.6 GeV/c ( $\pm$ )	$\sim 1\%$	mixed	$0.3-1.0 \cdot 10^6$	$\sim 0.02-5$	
Irrad1	24 GeV/c	0.015%	proton	$8-30 \cdot 10^{10}$	from MCR	primary
Irrad2	several MeV	unselected	neutrons			depends on T8

\*) Intensity is for 1% momentum bite, nominal target and  $2 \cdot 10^{11}$  ppp on target and intensity collimator(s) wide opened.

- Spill 400 ms (could be  $> 500$  ms at 20 GeV/c)
- Some more intensity control exists for the primary beam (0.5-1.0) and via the target efficiency ( $\sim 0.02-1.0$ ).

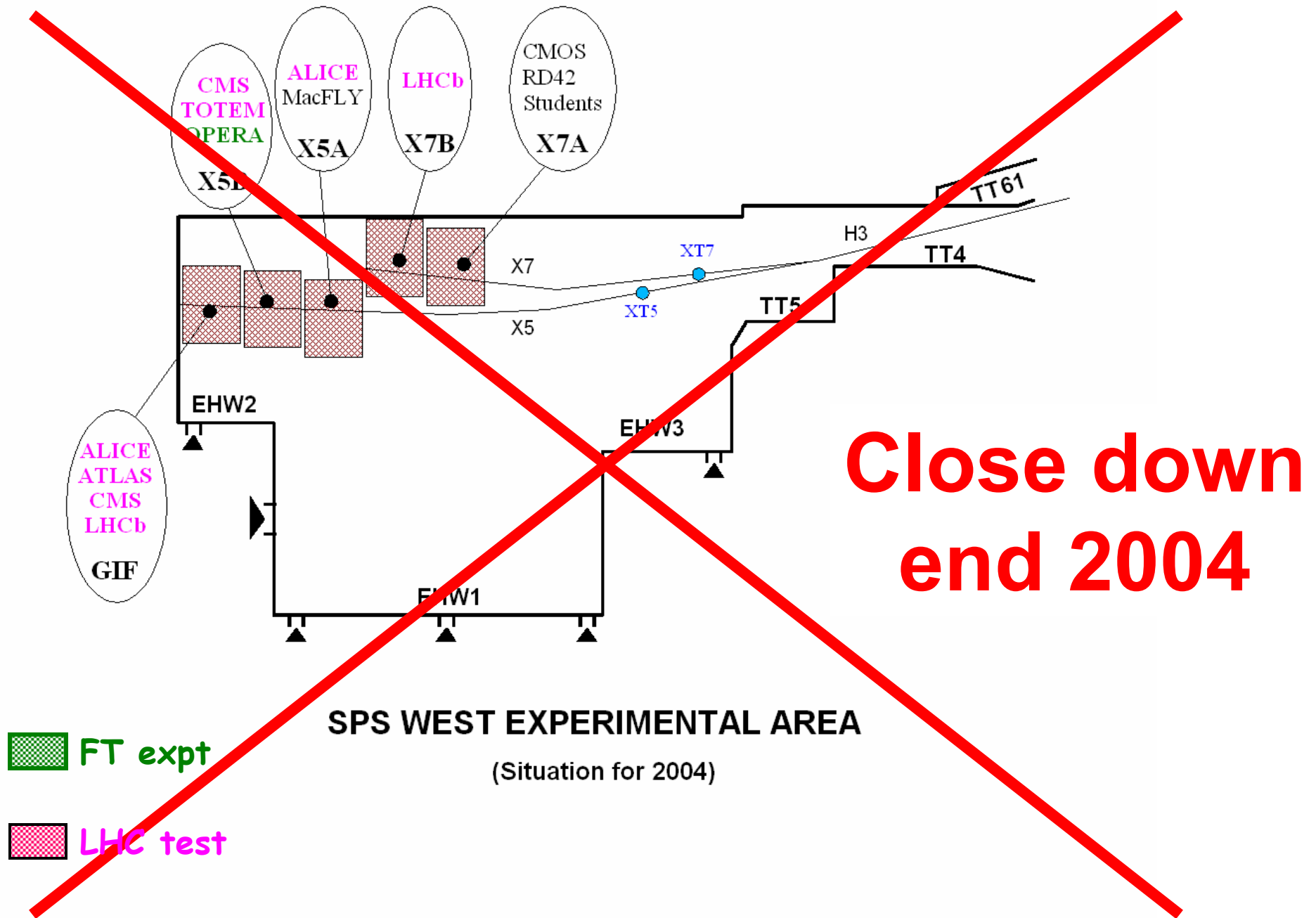

# Effects from WA closure

- The GIF facility will remain 'orphan' as far as the muon beam is concerned. However, it will remain operational as stand-alone source, operated by PH.
- The West Area test beam users expect to continue their activities in the other areas:

**LHCb** wants to move to the East Area and to EHN1, in particular VELO which would need space in EHN1 and the ECAL and HCAL who want to continue tests with 1 module of each. Some Silicon upgrade studies.  
Estimate : 50% of one beam.

**ALICE** will move most of WA activities to the T10 line in the East Area. ALICE expects to continue at 80% of its present programme.

**TOTEM** plans to commission its T1 telescope in 2006 and do intensive studies of its T2 telescope (Si + GEMs).  
Estimate 3-4 months late in 2006. More modest requests for 2007.

**CMS/TRACK** would also continue tests in EHN1.

*Some ideas are circulating or in the pipeline, though not (yet) ready for an official presentation at this meeting.*

*Among those I just mention the following:*

- *PH is contemplating a request for a **new GIF** in the North Area*
- *The present installation for **CERF** on the H6 beam is becoming too restrictive. A new and better shielded area should be considered.*



# IONS INTO THE NORTH AREA

After the long shut-down ions will be injected into the SPS via LEIR. The LEIR project has been launched for filling the LHC with ions. Filling the SPS instead will require more resources.

It should be noted that ion injection via LEIR for fixed target has not yet been studied in depth. More studies are required at the source, Linac3, LEIR, PS and at the SPS.

If the ions are required for the SPS fixed target program and if the required resources are made available, one might expect to get:

- Lead ions from 2009 (after PS-SPS-LHC ions running-in)
- Other (lighter) ions depending on LHC ion physics program.

It should be noted that many relevant non-radioactive ion species are possible 'in principle', but with significant preparation time and effort.

Note that North Area and LHC ions are exclusive if not the same ion

Possible intensities are up to  $10^9$  Pb<sup>54+</sup> from LEIR per transfer (3.6 sec). They can be limited in LEIR with an interlock based on a BCT measurement. Limitation of flux in EHN1 requires new TAX blocks (up to 300 kCHF/beam).

# THE M2 MUON BEAM

FOR COMPASS / NA58

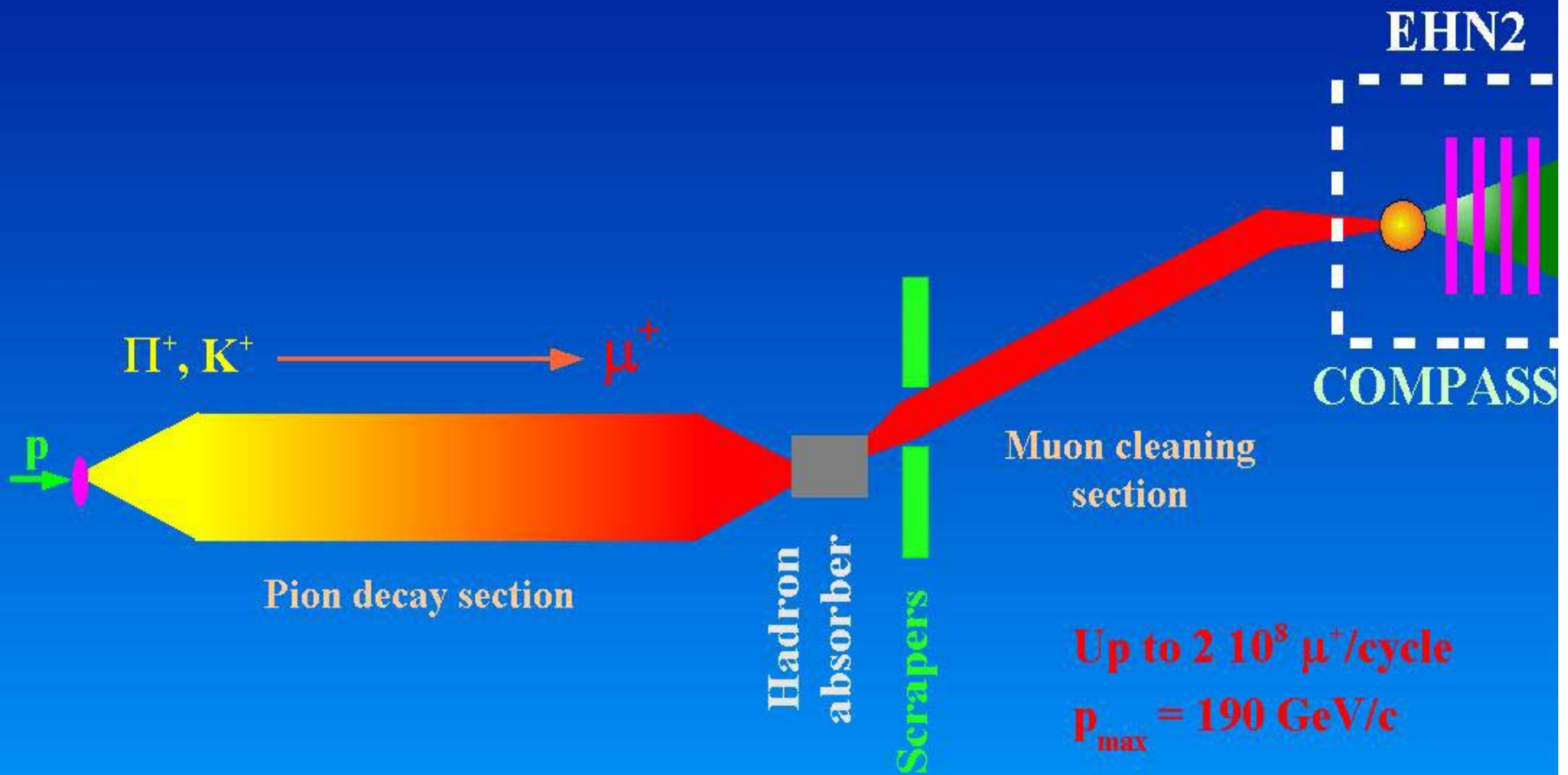

# Performance of M2 beam

The M2 beam has served a long series of well-known muon experiments, including NA4, EMC, NMC, SMC. Recently it has been adapted to the requirements for the COMPASS experiment, which needs

1. A high-intensity, high-energy muon beam up to 190 GeV/c,
2. A secondary hadron beam up to 280 GeV/c,
3. A possibility to calibrate with electrons (typically 40 GeV/c).

The change between these modes is fast (i.e. beam tuning only), but the changes inside the experiment may take much longer.

A second phase with primary proton beams and/or high-intensity hyperon beams was mentioned at the time of the COMPASS proposal.

However, those would require a complete rebuild of the more 1100 m long M2 beam line (stronger dipoles, smaller aperture quadrupoles) and be incompatible with high-intensity muon beam operation.

# Muon beam performance

Parameter	Range	Comments
Beam momentum [GeV/c]	<b>60-190</b>	
Maximum flux per cycle	<b><math>2 \cdot 10^8 \mu^+</math> @ 160 GeV/c for <math>1.2 \cdot 10^{13}</math> ppp on T6</b>	Limited by RP See slide on next page
Spot size at pol. target	<b><math>8 \times 8 \text{ mm}^2</math> RMS</b>	For $p > 100 \text{ GeV/c}$
Beam divergence	<b><math>0.4 \times 0.8 \text{ mrad}^2</math> RMS</b>	
Momentum spread	<b>3% RMS</b>	
Beam polarisation	Up to 80%	Depends on $p_\mu/p_\pi$
Hadron contamination	<b><math>&lt; 10^{-6}</math></b>	Estimate
Halo	<b>16%</b> <b>6%</b>	Small counter, $\Phi=60$ Large area, $\Phi=300$

# Technically possible muon flux per spill in M2 (based on measurements)

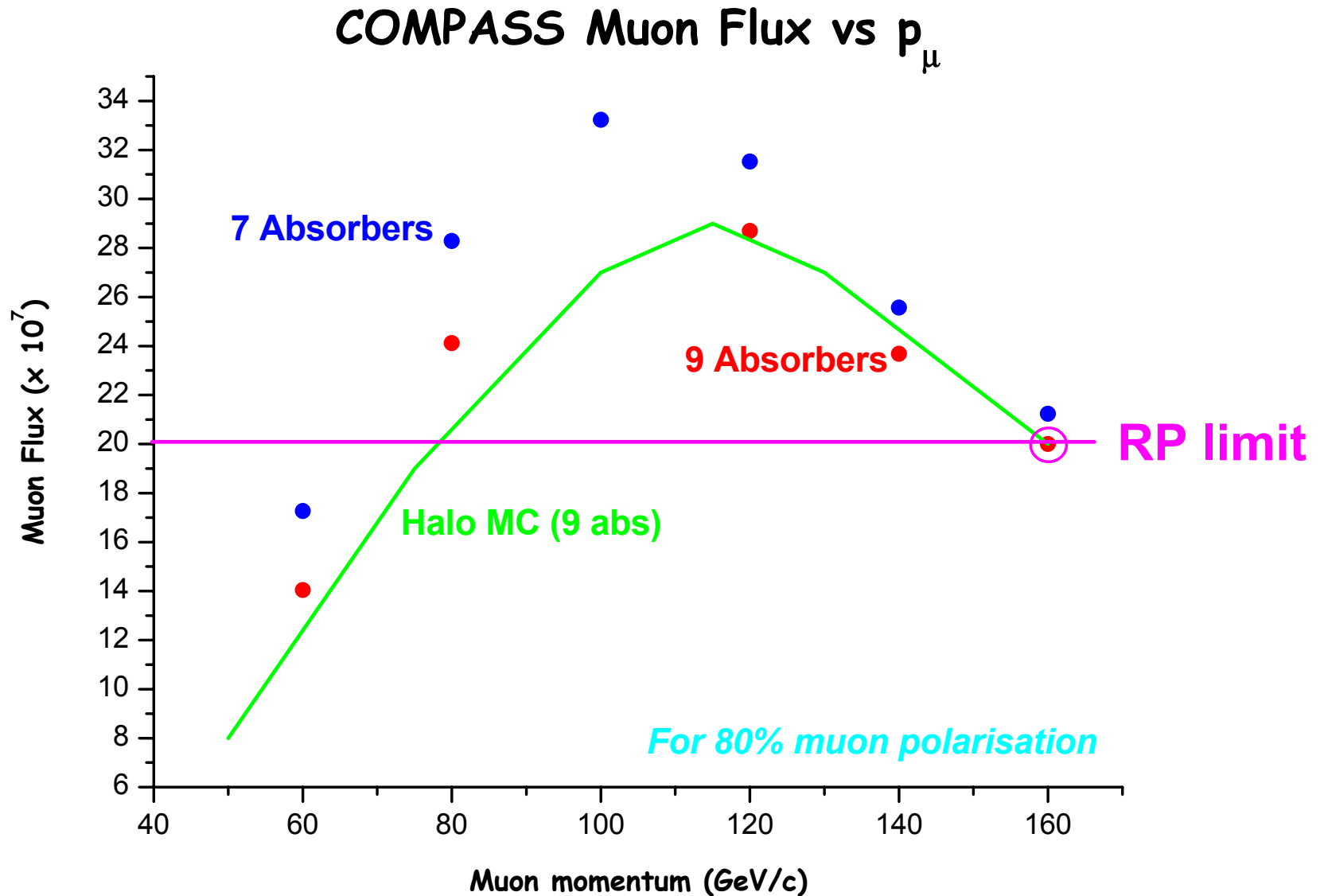

# Impact of proton momentum:

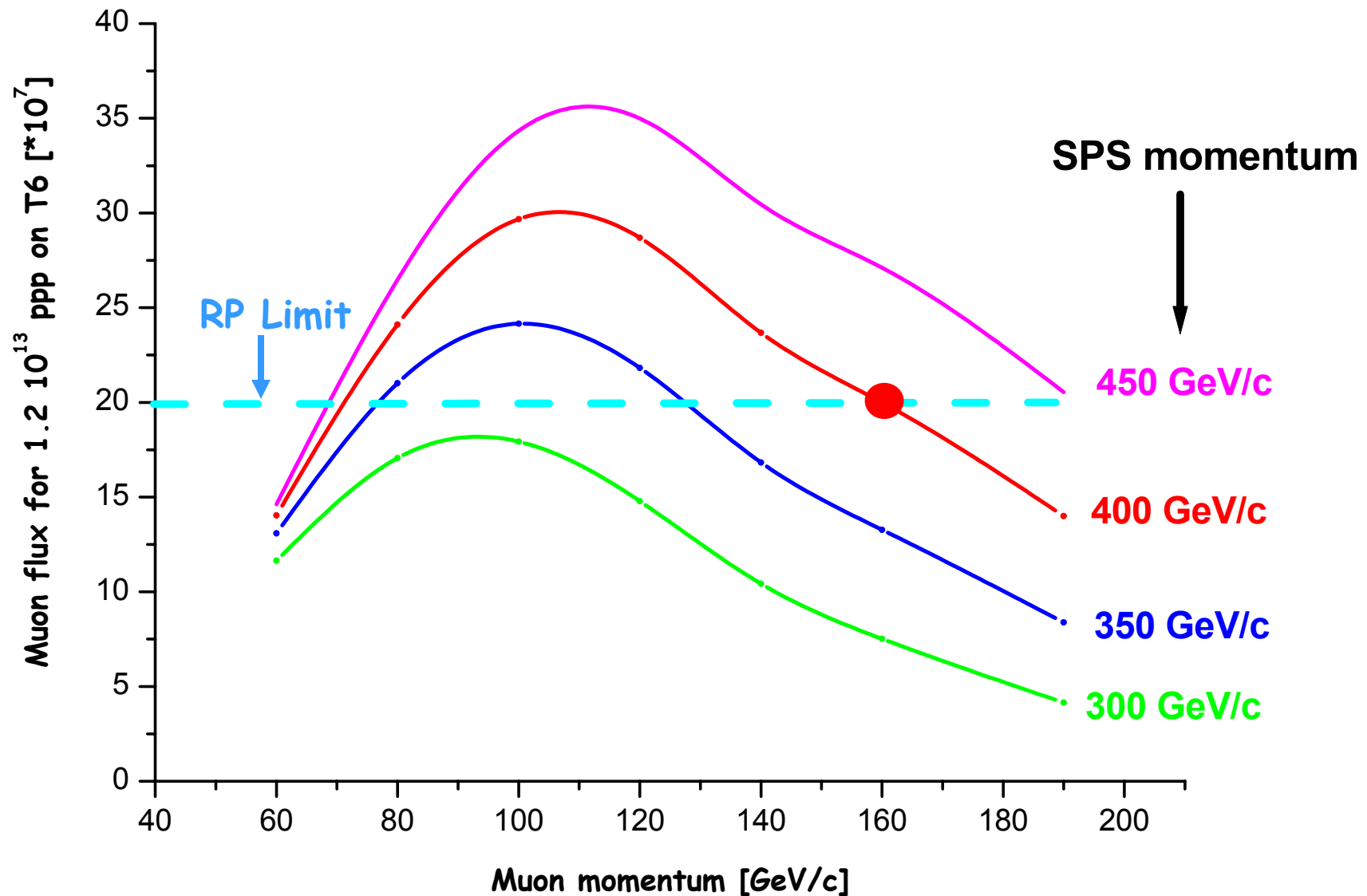

**But smaller flat top/duty cycle at 450 GeV/c**

Or, for 160 GeV/c muons (from 172 GeV/c hadron decays):

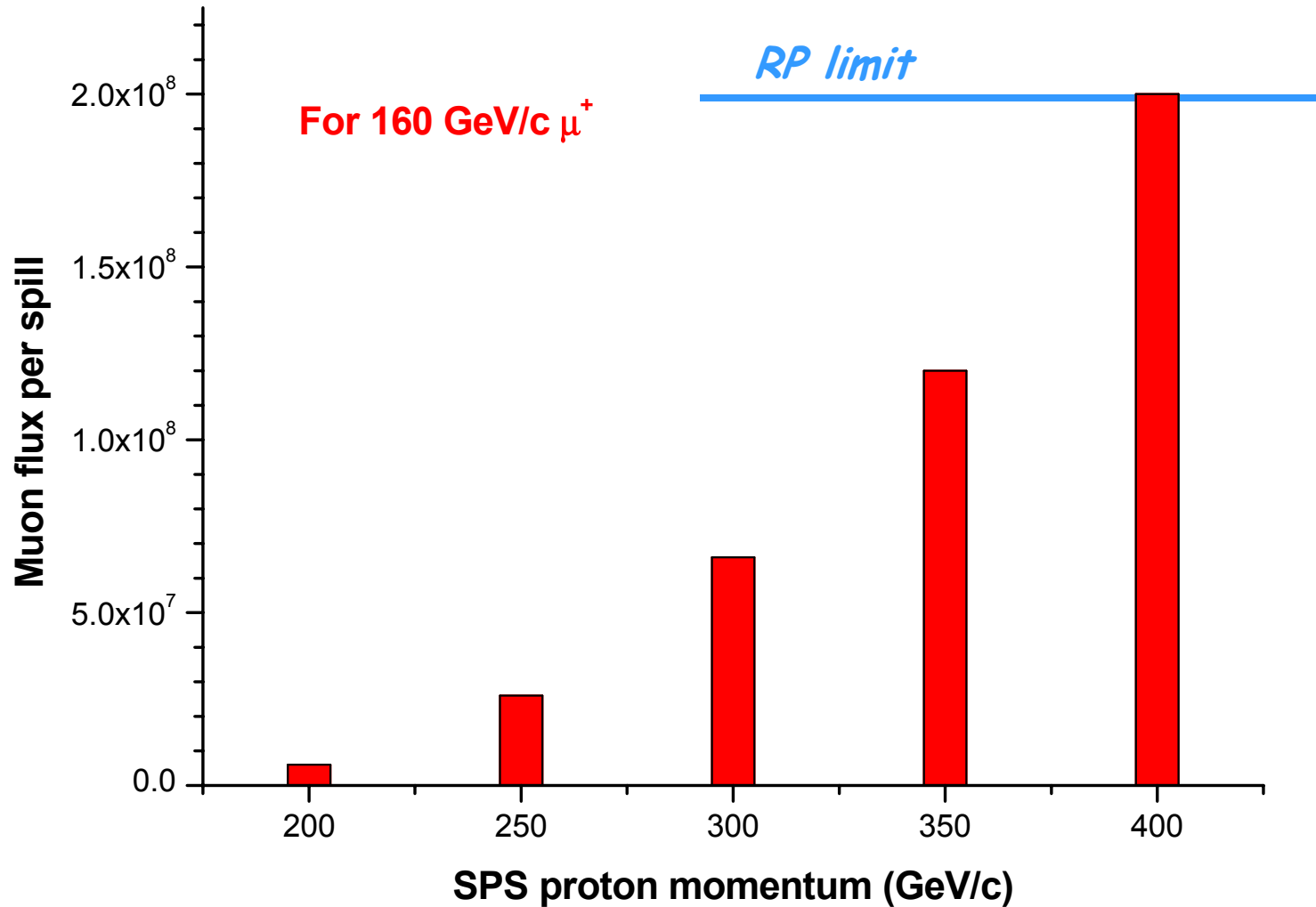

**Apart from radiological limits, there are numerous technical limitations:**

**Those include:**

**NA extraction septa**

**Splitters**

**T6 primary target**

**TAX blocks**

**Shielding, CERN fences**

**All these limit the flux at about the present level.**

**More detailed calculations are under way.**

**However, significant flux increases would require major modifications.**



## The M2 as a hadron beam

The M2 line can also be operated as a secondary hadron beam, by removing the 9 Beryllium absorbers, 1.1 m long each, from the beam axis and by using a different beam optics.

As an example some performance parameters are given below:

Parameter	Range	Comments
Beam momentum (GeV/c)	60 - 280	
Momentum resolution	1%	
Max. beam flux per pulse	$< 10^8$ ppp	Limited by RP & shielding
Beam spot (mm)	$\approx 3-4$ mm RMS	Can be modified
Divergence (mrad)	few 0.1 mrad	Depends on rate
Halo	$\leq 2\%$	Depends on rate and p

# The PO Complex (ECN3)

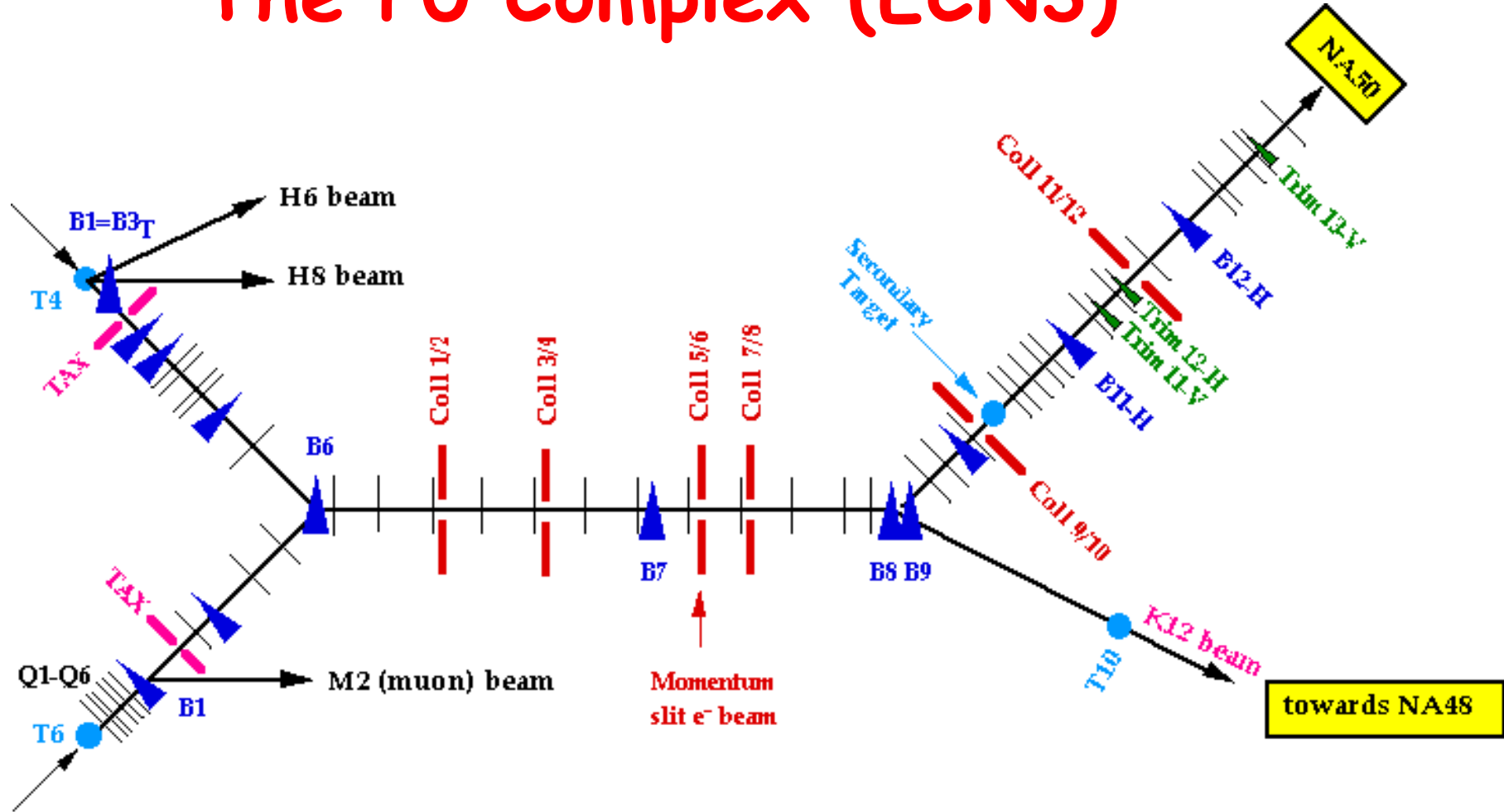

SCHMATIC VIEW OF THE P41 / P42 / P61 / P62 BEAMS

**P41/P61: primary proton or ion beam. Flux limited by radiation 'hygiene' only**

# THE SIMULTANEOUS $K_L$ AND $K_S$ BEAMS

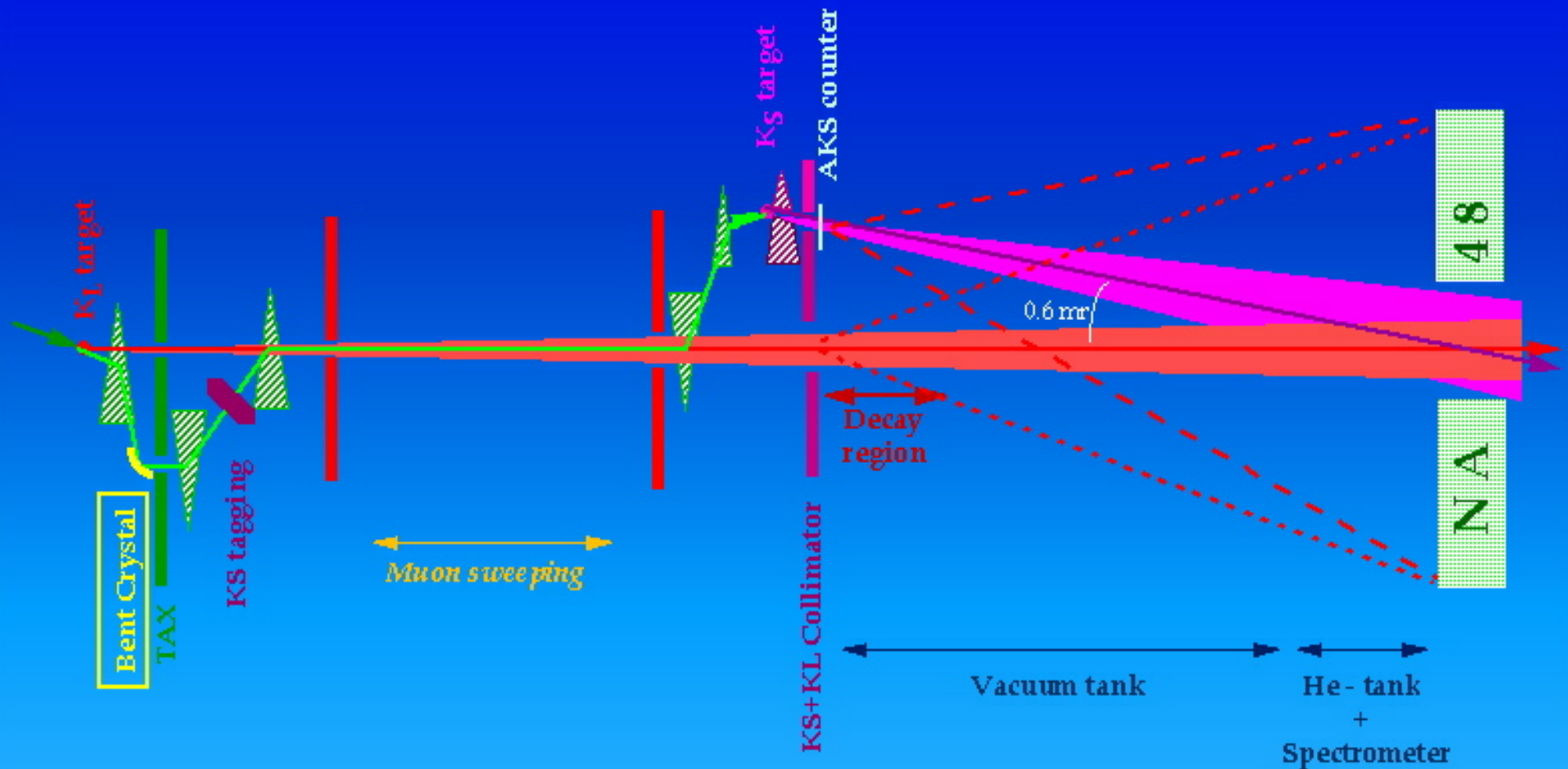

# The NA48/2 BEAM LINE - SCHEMATIC VIEW

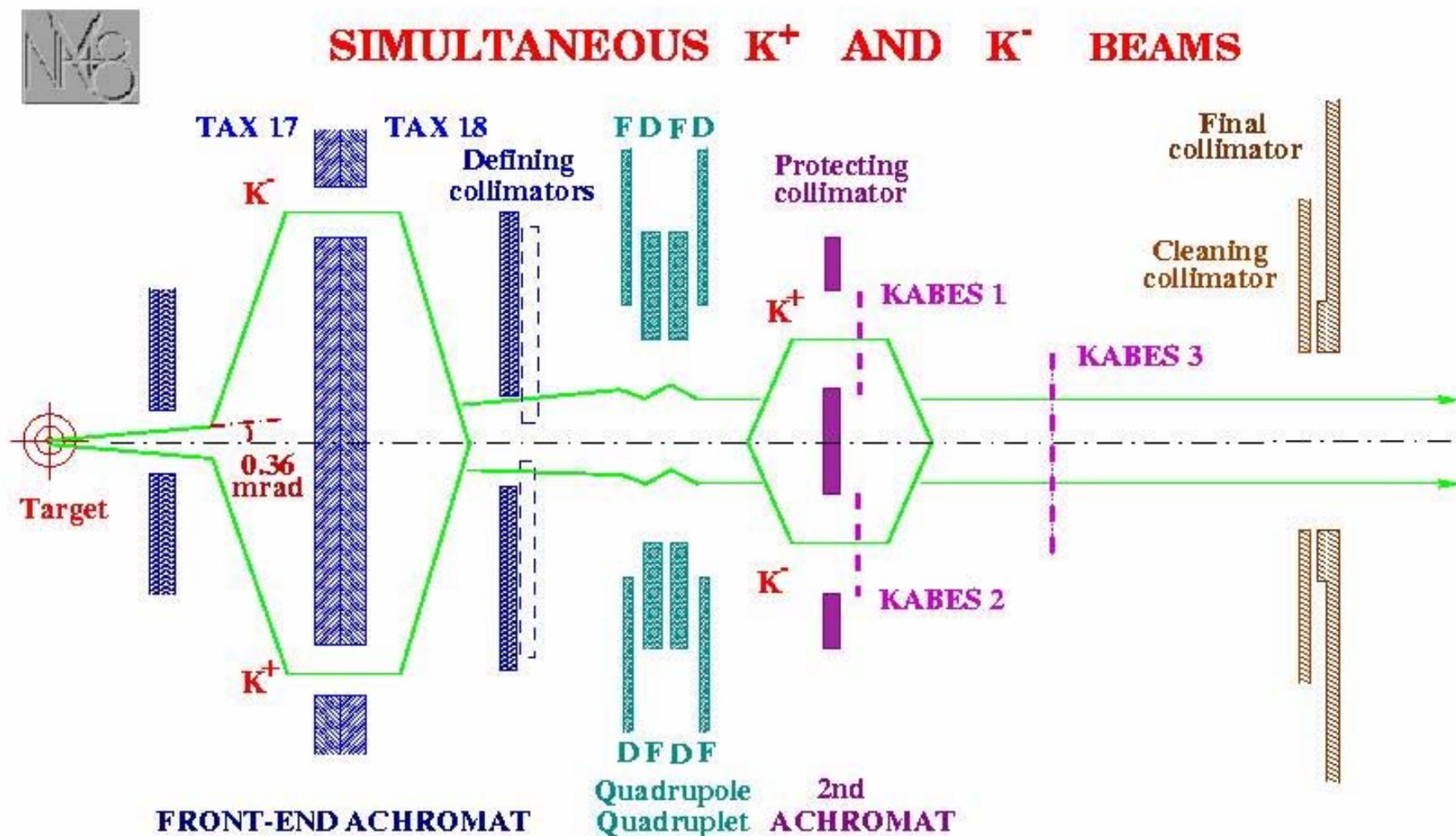

## RF-SEPARATED VS UNSEPARATED KAON BEAMS

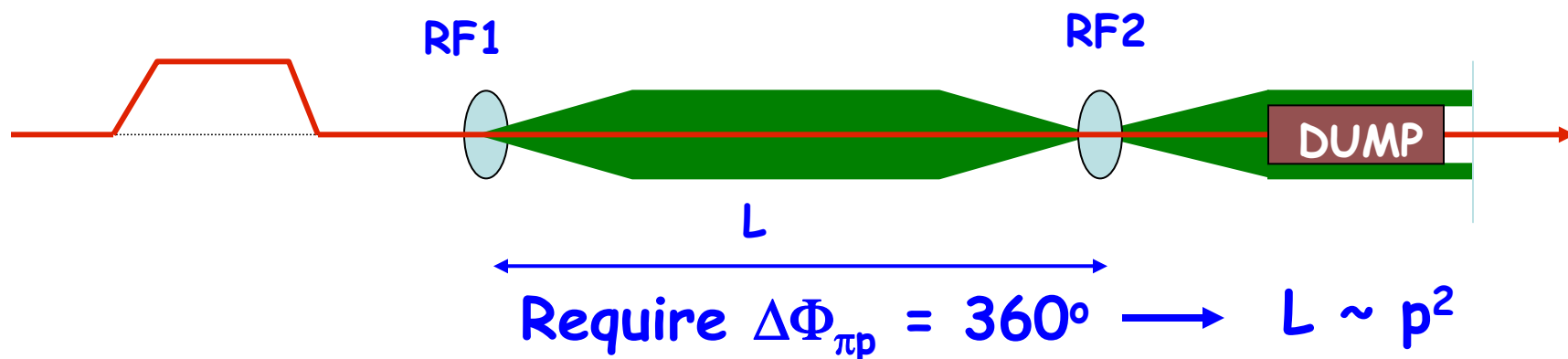

Quite pure Kaon beams, but decays  $\sim p$ ,  $L \sim p^2$ , coherence volume, ...

**➔ Expect at most  $2-3 \cdot 10^5$   $K^+$  per burst at high  $p$**   
 Compare:  $3 \cdot 10^6$   $K^+$ /pulse in 2003 and 2004 !

Unseparated beam can accept larger angles and momentum bite,  
 e.g. few % DP, few mrad. Hence acceptance  $\approx 100$  times larger

**But have to tag some  $10^9$  particles per spill**

Positive:	$K^+$ : 6.2%,	$\pi^+$ : 71.1%,	$p$ : 22.7%
Negative:	$K^-$ : 6.8%,	$\pi^-$ : 90.8%,	$\bar{p}$ : 2.4%

**Could get 40x more  $K^+$  decays per year than now (scheduling?)**

**SCHEMATIC LAYOUT (HORIZONTAL PLANE)**  
**OF HIGH-INTENSITY K<sup>+</sup> BEAM**  
**DECAY FIDUCIAL REGION & NA48/3 DETECTORS:**

- PHOTON VETO 1 :  $40 \leq r \leq 90$  mm
- PHOTON VETO 2 :  $r \geq 90$  mm
- PHOTON VETO 3 :  $r \leq 100$  mm
- LKr CAL :  $120 \leq r \leq 1200$  mm

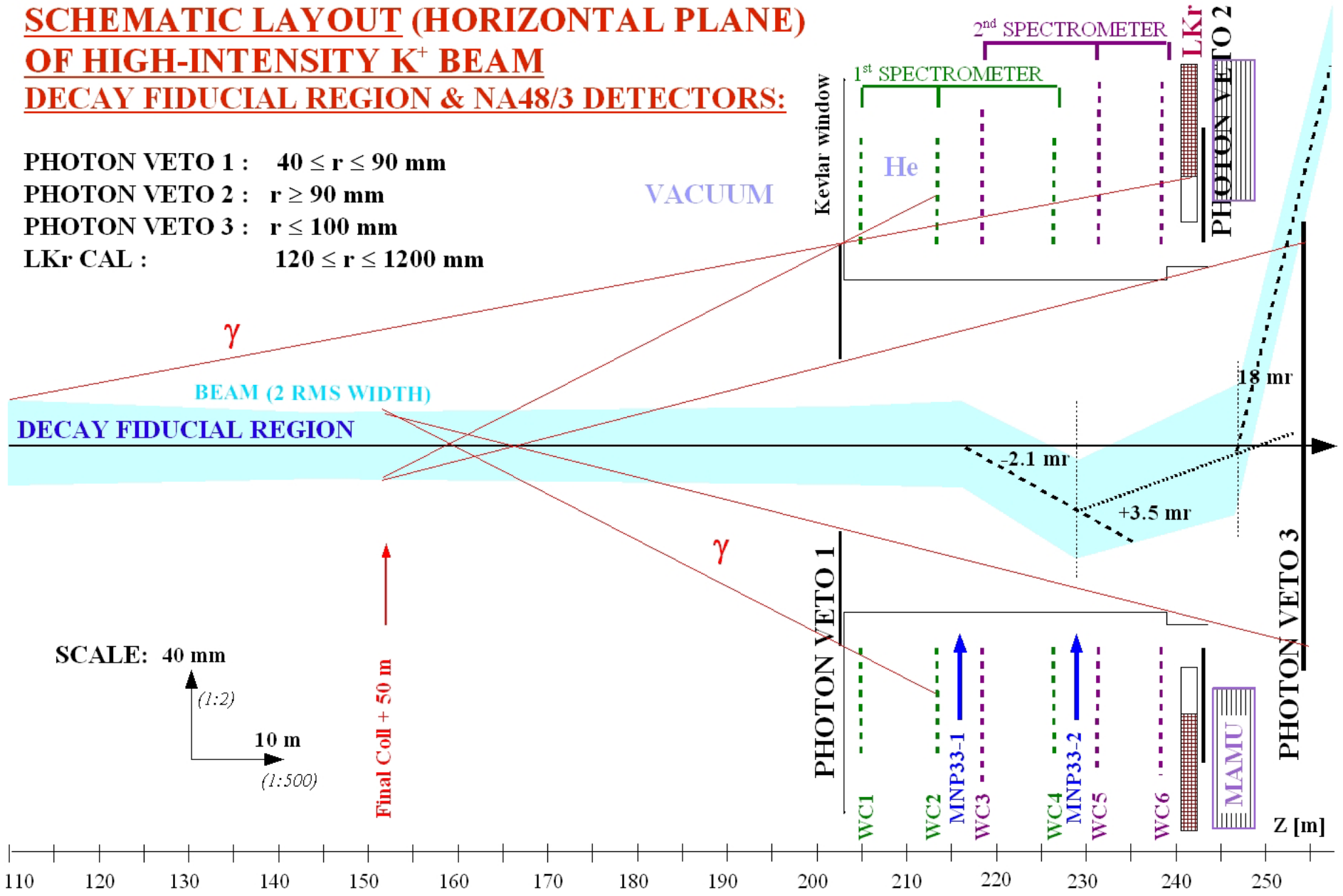

# Coupling between M2 and P61\*) beams

(P61 = P0 beam when derived from T6 target)

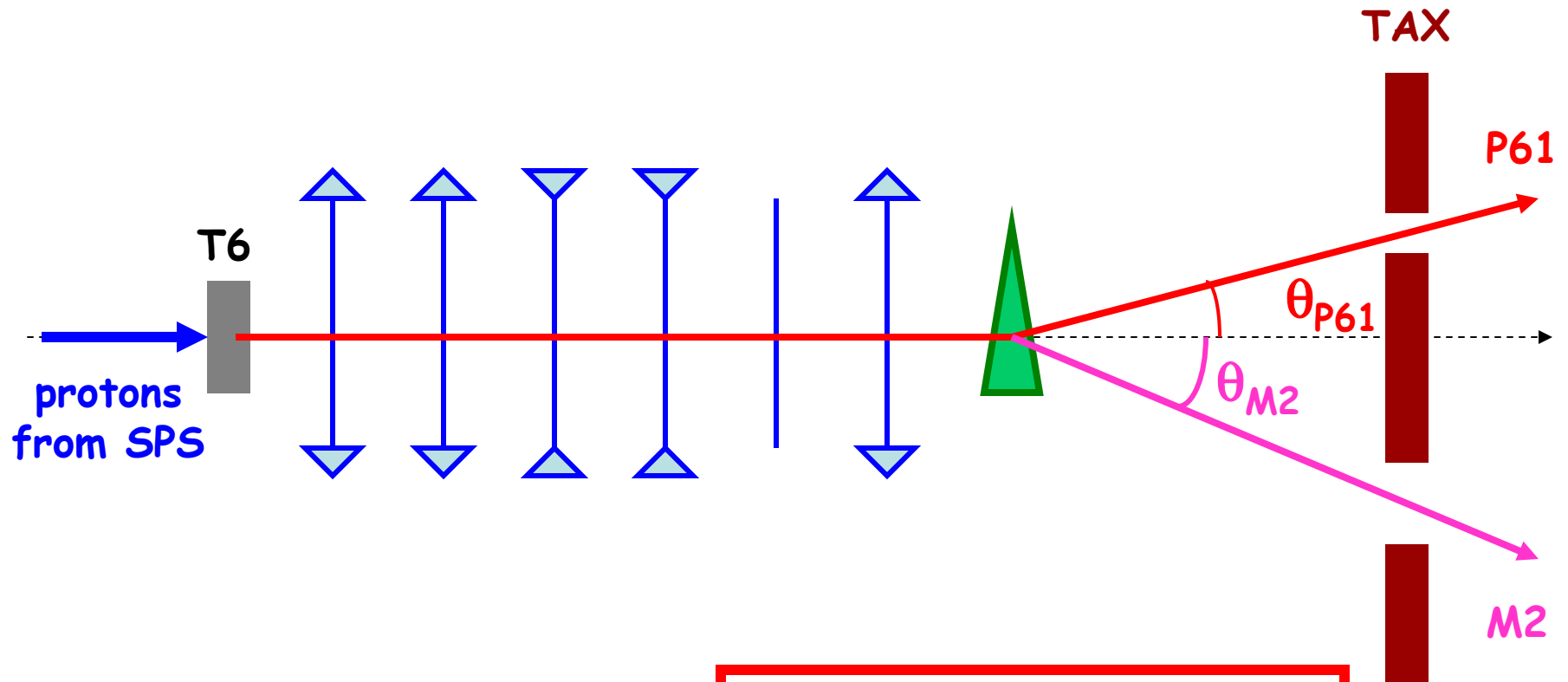

$$\theta_{P61} = \theta_{M2} / 2$$



$$p_{M2} = - p_{P61} / 2$$

## Consolidation of North and East Area

- With the **closure of the West area**, lots of equipment are liberated as spares, in particular magnets and collimators, as well as instrumentation. Regular magnet maintenance will continue.
- The Camac-based electronics for NA beam instrumentation is being replaced by **new and modern, industry standard VME hardware**. This renovation program will be completed by the end of the long shutdown.
- The old nodal beam control in the North Area will be replaced by **new software (Cesar)**. The West Area has already been operating with Cesar and the North Area will be moved to Cesar as soon as possible, before the end of the 2004 run.
- Renovation of the old (resource consuming) electronics and cabling for rectifiers will be absolutely vital in the coming years, as soon as possible (but only after LHC completion, due to budget constraints).  
**The MTBF is now below 5000 hours!**
- **The instrumentation in the East Area** is very poor. A harmonization to NA standards, using WA equipment and/or technology, is under study.
- **Magnets in the East Area** are partly in a bad state. Consolidation of the more critical types is under way.



## The AD

The Antiproton Decelerator is a facility that provides low-energy antiprotons to 4 experiments: ATHENA, ATRAP, ASACUSA and ACE. Typical antiproton momenta delivered are 100 MeV/c for the first three and 300 MeV/c for ACE (=AD4).

Main objective so far was the study of antimatter and CP(T) violation. Now AD4 is studying applications in health physics.

The hall has a surface of about 60x50 m<sup>2</sup> and is normally freely accessible during  $\bar{p}$  operation. It is technically possible to run protons for test purposes, in which case access is forbidden.

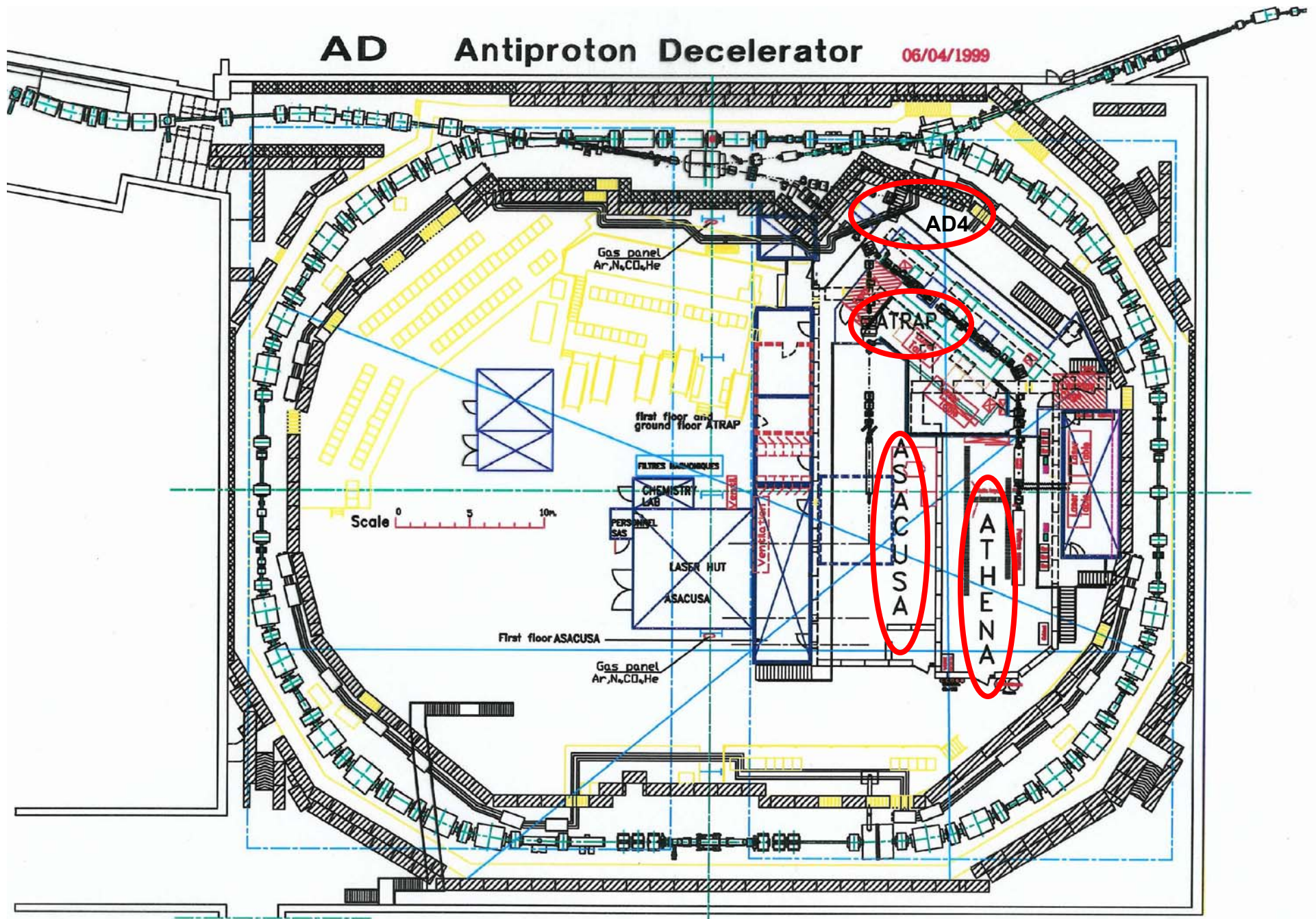

22 September 2004

Possible future of experimental areas  
Villars Meeting of SPSC

**3-D View:**

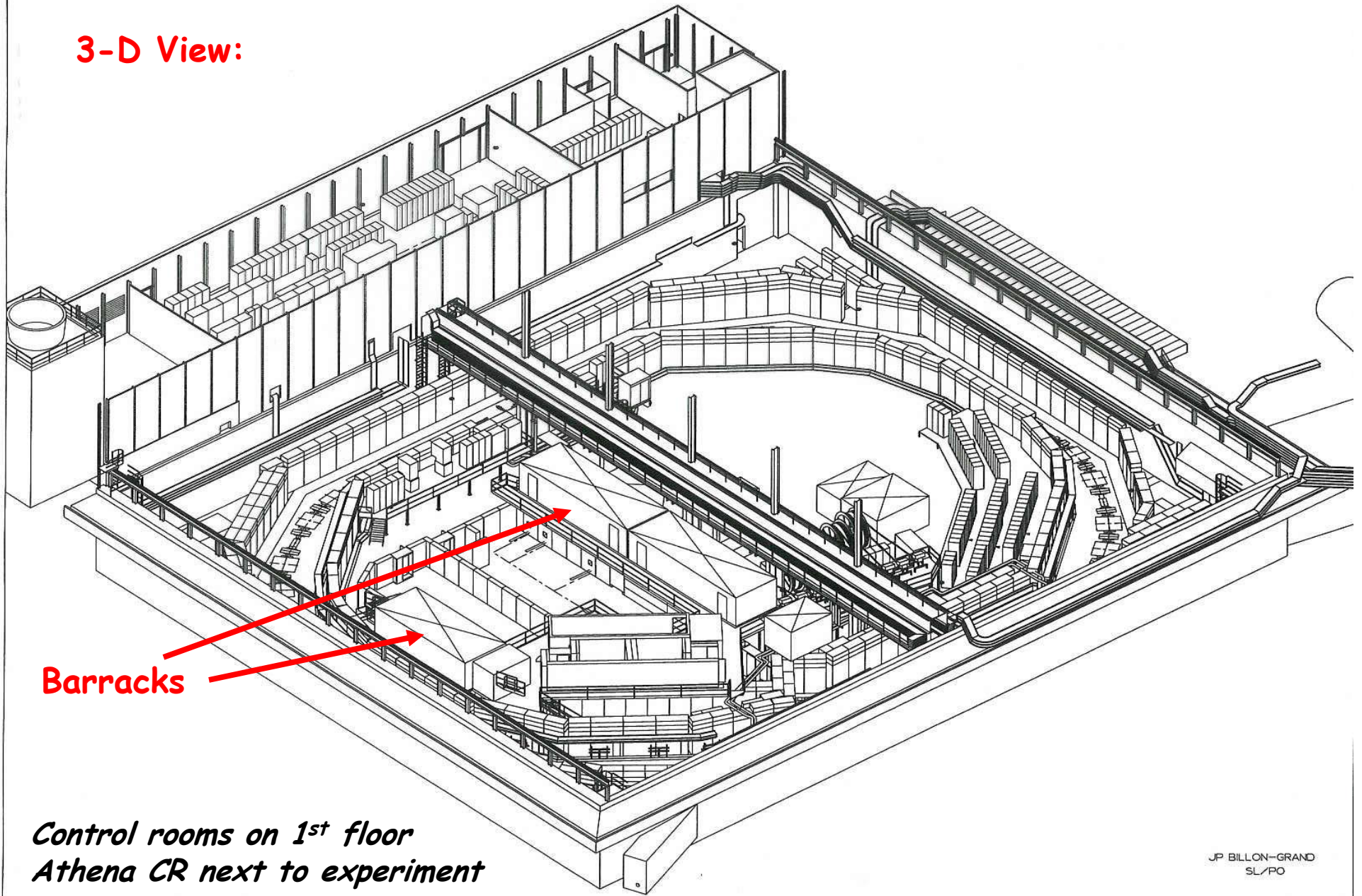

**Barracks**

*Control rooms on 1<sup>st</sup> floor  
Athena CR next to experiment*

JP BILLON-GRAND  
SL/PO

# Basic AD Deceleration Cycle

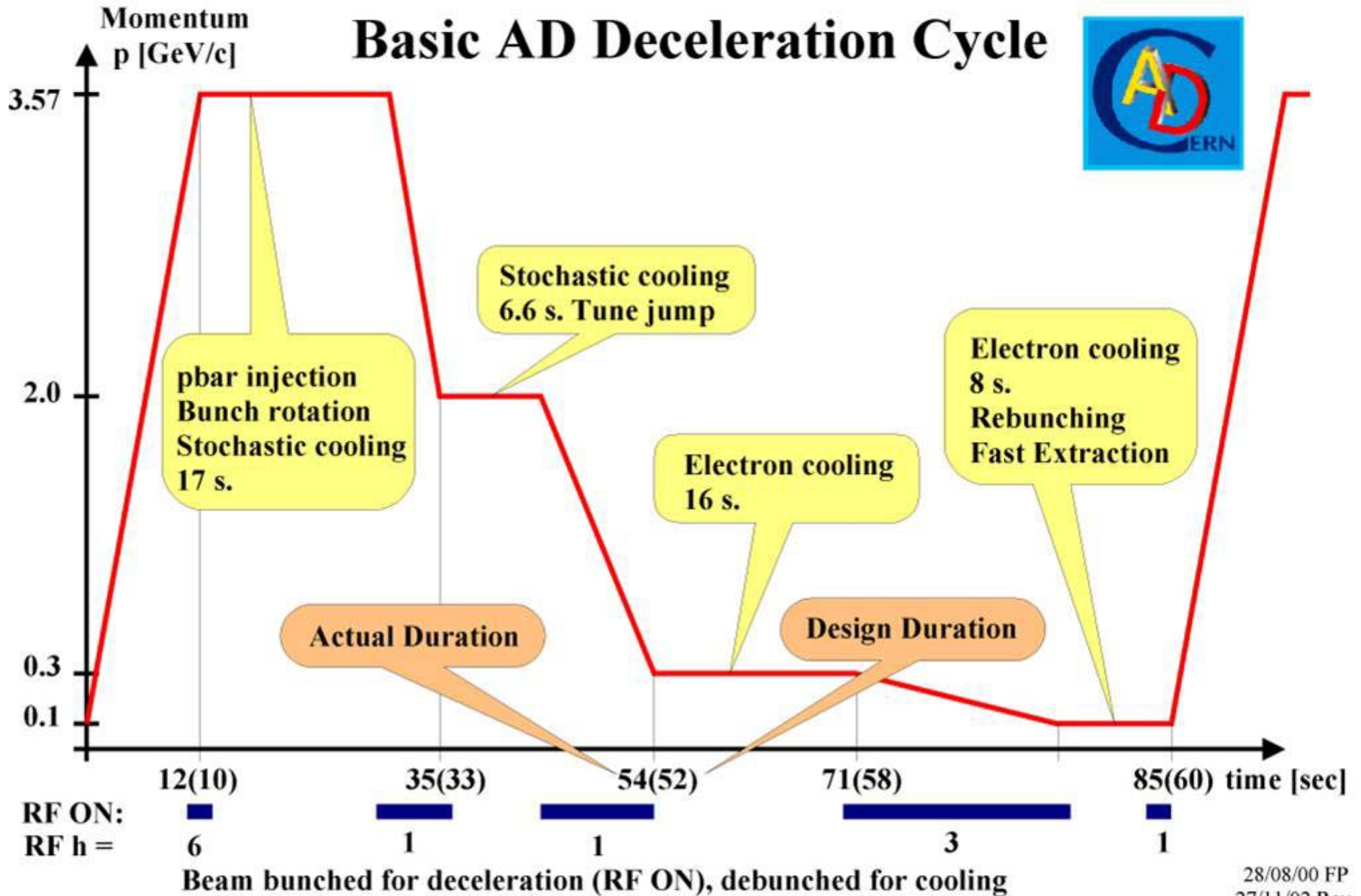

28/08/00 FP  
27/11/02 Rev.

## Current Status:

Parameters		Design value	Achieved so far
<b>at 3.5 GeV/c</b>	Number of antiprotons [10 <sup>7</sup> ]	5.0	5.0
	Hor/Vert acceptance [μm]	200/200π	200/180π
	Stochastic cooling time [s]	20	17
	Transverse emittances, 2σ [μm]	5π	3π
	Total energy spread, 4σ [10 <sup>-3</sup> ]	1.0	1.00
<b>at 2.0 GeV/c</b>	Stochastic cooling time [s]	15	6.6
	Transverse emittances, 2σ [μm]	5π	3π
	Total energy spread, 4σ [10 <sup>-3</sup> ]	0.3	0.2
<b>at 300 MeV/c</b>	Electron cooling time [s]	6	13.8
	Transverse emittances, 2σ [μm]	2π	3-6π hv
	Total energy spread, 4σ [10 <sup>-3</sup> ]	1.0	0.15
<b>at 100 MeV/c</b>	Electron cooling time [s]	1	8.4
	Transverse emittances, 2σ [μm]	1π	< 1π hv (core)
	Total energy spread, 4σ [10 <sup>-3</sup> ]	0.1	0.10

## Ejected beam

Parameters		Design value	Achieved so far	
<b>at extraction</b>	Total energy spread, $4\sigma$ [ $10^{-3}$ ]	1 - 0.1	100 MeV/c	300 MeV/c
	Bunch length [ns]	200-500	0.8-0.4	0.15
	Number of antiprotons [ $10^7$ ]	1.2	90-200	300
	Cycle time [s]	60	3.0	3.3
			84	84

*At 100 MeV/c, bunch rotation allows to achieve shorter  $\Delta t$  vs larger  $\Delta p$*

## Possible developments

- Instead of fast extraction it is possible to extract on 3rd or 6th harmonic, 3 - 6 shots, 2.4 seconds apart
- A second RFQD (RF decelerating quadrupole) has been under discussion.  
This would replace the functionality of degrader foils, but without the losses inherent to those.
- Also one may consider a decelerating ring, e.g. ELENA, as submitted to this meeting

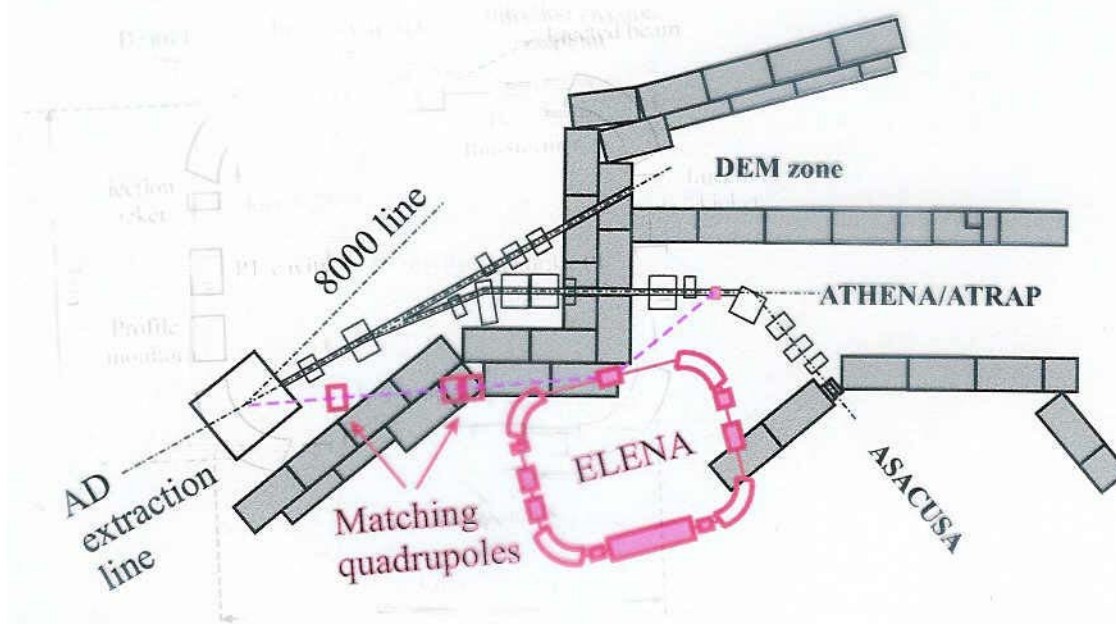

With such options one might reduce  $E_{kin}$  further to e.g. **100 keV** instead of **5.3 MeV**. Some modifications of the beam lines would be necessary.

## Possible developments (cont'd)

Several ways of improving the AD performance have been suggested, but not yet been studied in detail or discussed officially:

- Stacking at injection might increase the intensity by a factor of order 2-5. So far only a short study (proof of principle) has been done.
- The PS production beam could possibly be improved from 4 to 5 bunches. This would increase the proton flux by a factor 1.25, but needs 3.6 sec. This was never done yet.
- A long-term AD program would require some consolidation, e.g. improved instrumentation, (ex: non-destructive electro-static pick-ups).



# Other Experimental Areas at CERN

CNGS



Konrad Elsener's talk

Isolde

nTOF

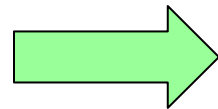

INTC Committee

# CERN NEUTRINOS TO GRAN SASSO

## Underground structures at CERN

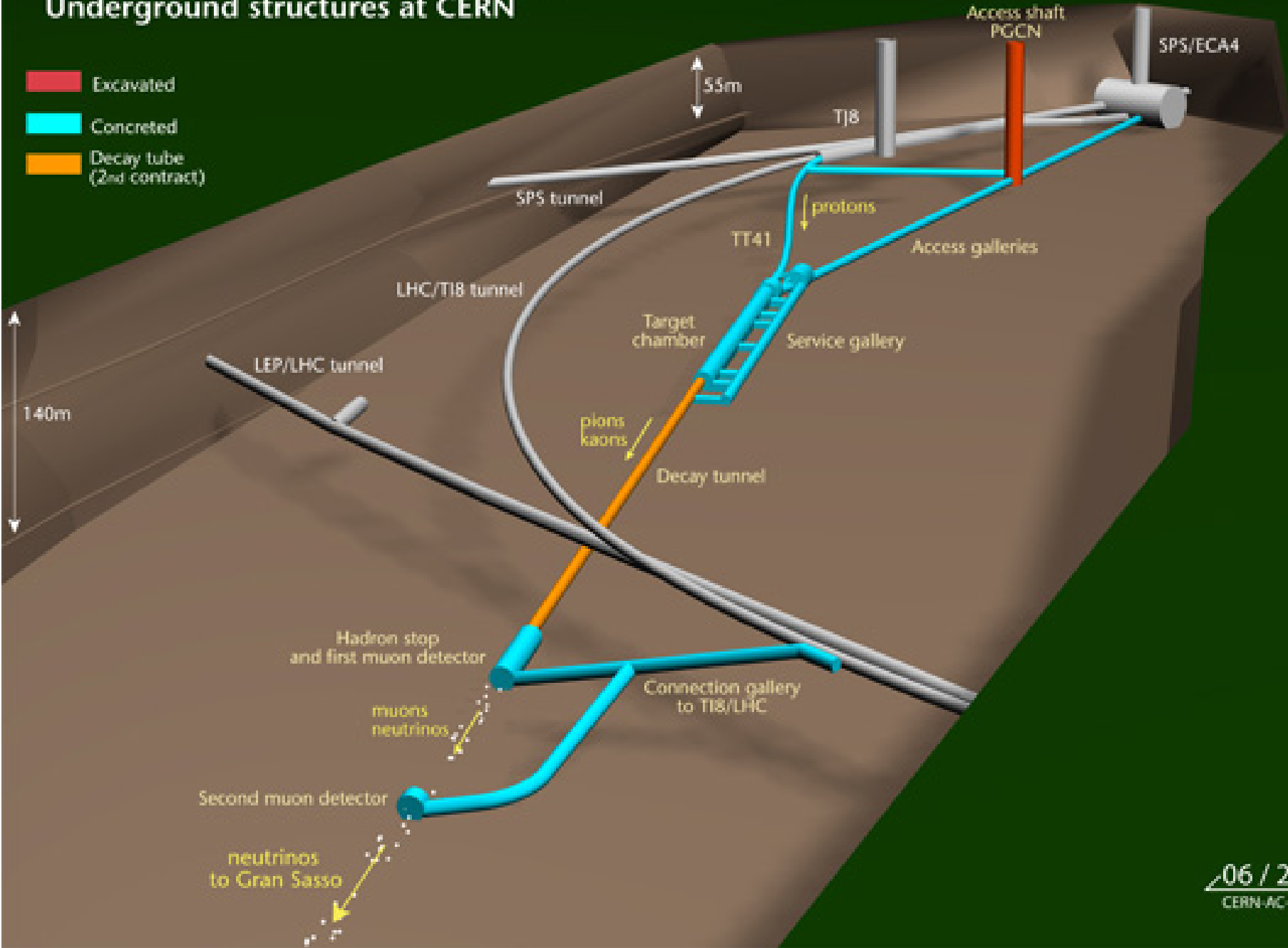

# ISOLDE

- Two separators: GPS and HRS
- REX-ISOLDE post-accelerator
- Approx. 350 eight hour shifts of physics/year (400 Users)
- Hall extension in progress

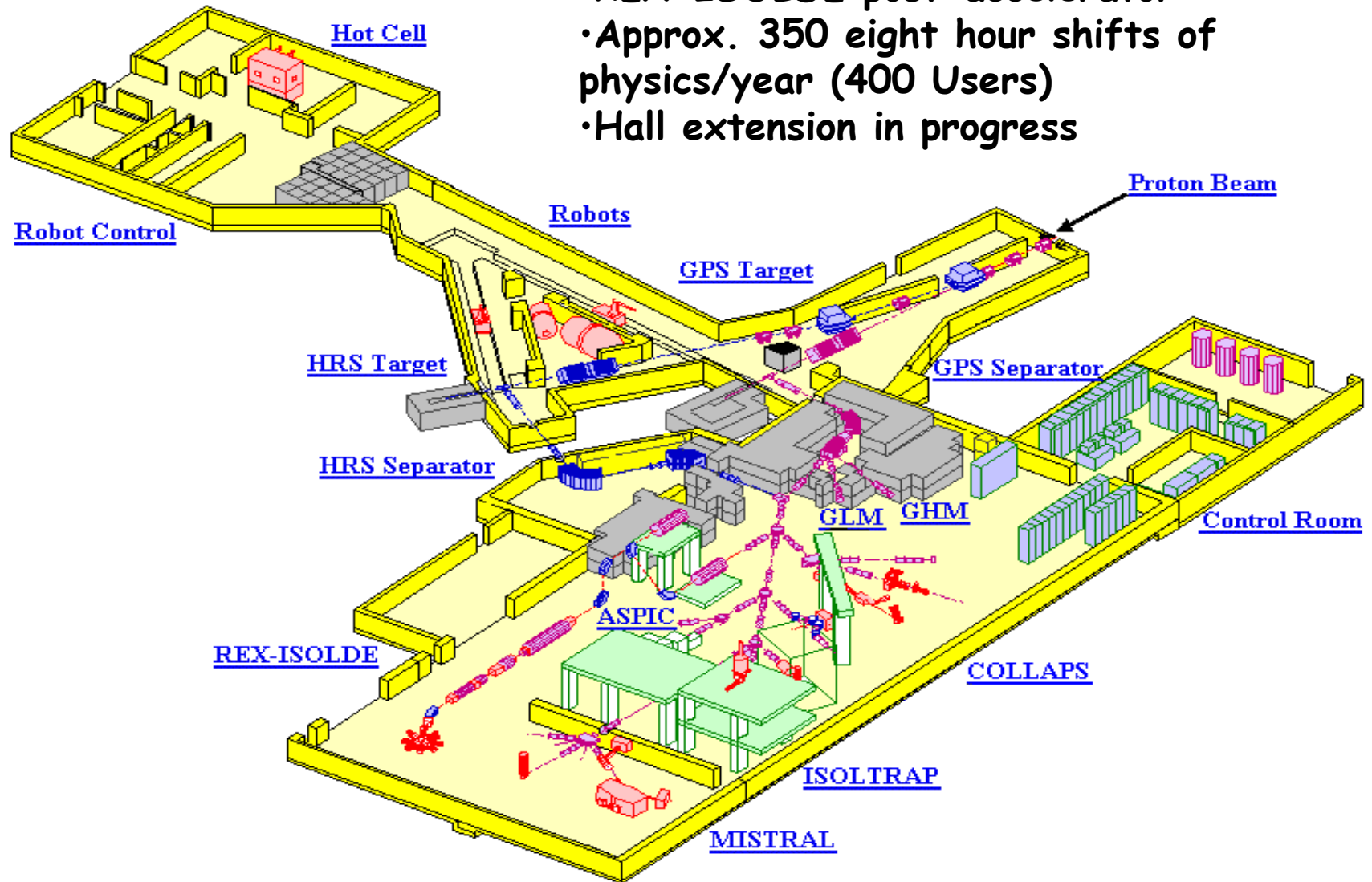

# CERN $n$ \_TOF

1. Neutron cross section measurements for nuclear waste transmutation
2. Understanding stellar nucleosynthesis
3. Neutrons as probes for fundamental nuclear physics

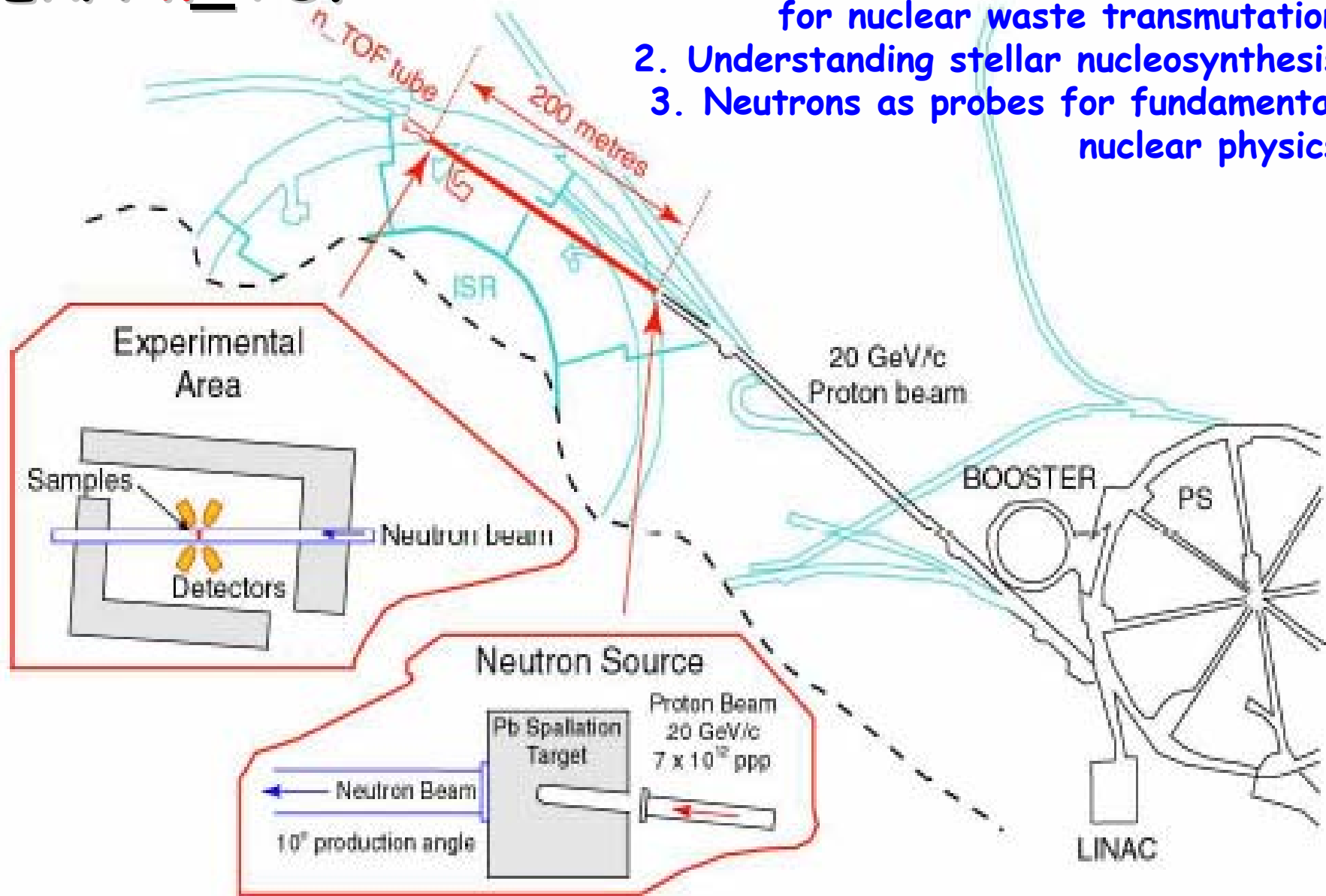

# Spallation target:

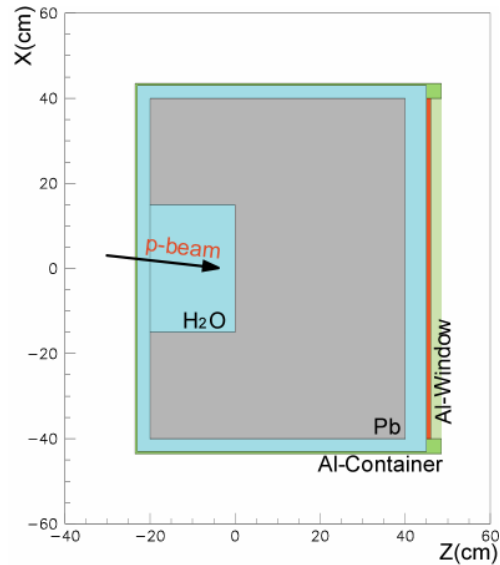
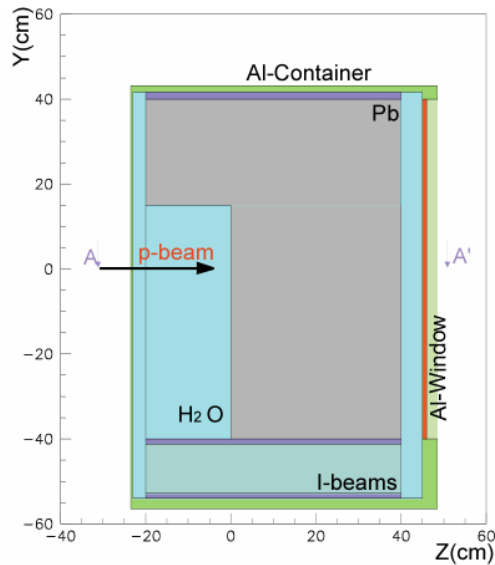

# nTOF Beamline:

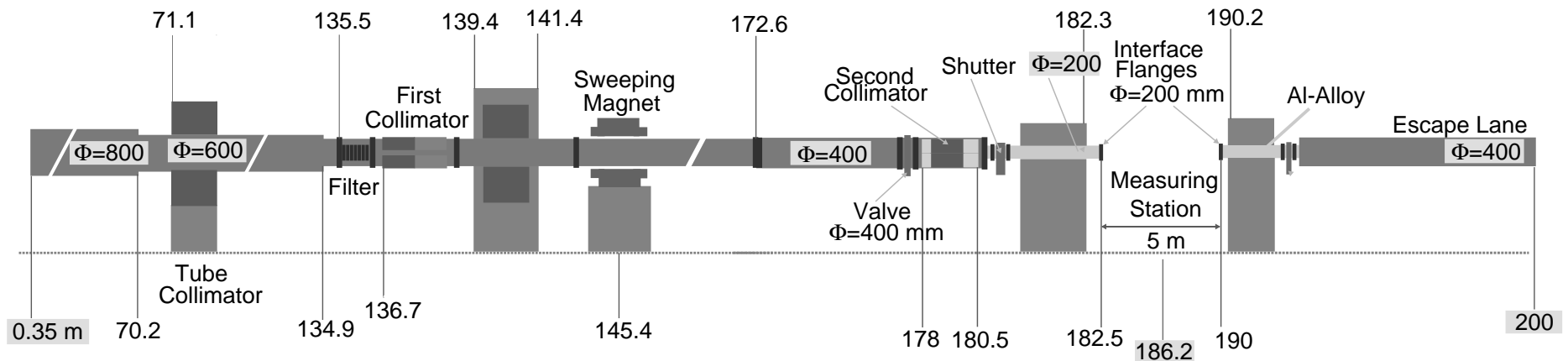

## Unique Features of n\_TOF

- High Neutron Flux:  $\sim 7 \times 10^5$  n/cm<sup>2</sup>/7×10<sup>12</sup>p
- Long flight path 185 m
- Broad Energy Spectrum: 1 eV to 250 MeV
- Energy Resolution:  $\Delta\lambda = 1.8$  cm @ low  $E_n$
- Small intrinsic photon (0.1  $\gamma$ /n) and charged particle (0.2 c/n) contamination
- Small repetition rate 1/1.2 s<sup>-1</sup> (in dedicated mode)
- Small neutron background  $< 10^{-6}$  relative

# Approved nTOF Physics Programs

- NTOF1** - European Collaboration for High-Resolution Measurements of Neutron Cross Sections between 1eV and 250 MeV
- NTOF2** - Determination of the Neutron Fluence, Beam Characteristics and Background at CERN-PS n\_TOF Facility
- NTOF3** - The Importance of  $^{22}\text{Ne}(\alpha, n)^{25}\text{Mg}$  as s-Process Neutron Source and the s-Process Thermometer  $^{151}\text{Sm}$  [Neutron Capture on  $^{151}\text{Sm}$ ]
- NTOF4** - Re/Os Cosmochronometer [Neutron Capture on Os isotopes]
- NTOF5** - n\_TOF-05: Neutron Cross Sections for the Pb Isotopes: Implications for ADS and Nucleosynthesis
- NTOF6** - Measurements of Fission Cross Sections for the Isotopes relevant to the Thorium Fuel Cycle
- NTOF7** - Measurement of the neutron capture cross sections of  $^{232}\text{Th}$ ,  $^{231}\text{Pa}$ ,  $^{234}\text{U}$ , and  $^{236}\text{U}$
- NTOF8** - Neutron capture cross sections of Zr and La: probing neutron exposure and neutron flux in Red Giant Stars
- NTOF9** - Measurements of Fission Cross Sections for Actinides
- NTOF10** - Measurement of the neutron capture cross sections of  $^{233}\text{U}$ ,  $^{240}\text{Pu}$ ,  $^{242}\text{Pu}$ ,  $^{241}\text{Am}$ ,  $^{243}\text{Am}$  and  $^{245}\text{Cm}$  with a Total Absorption Calorimeter at n\_TOF

# Final Remarks

CERN has available a unique facility of experimental areas which are performant, diverse and flexible:

- The North Area at the SPS has the potential to house experiments not only in EHN2 and ECN3, but also in EHN1.
- CNGS will start up in 2006.
- Ion beams for FT can be provided from 2009 onward.
- The East Area has also the capability to house experiments, in particular in the T8 primary beam line.
- The AD houses at present 4 experiments and ideas for further upgrading exist.
- Other experimental areas exist at CERN, at lower energies, in particular nTOF and ISOLDE.

Due to their flexibility and possibility to provide specific beams, they can house a physics program complementing the one at LHC.



## RF-SEPARATED VS UNSEPARATED KAON BEAMS

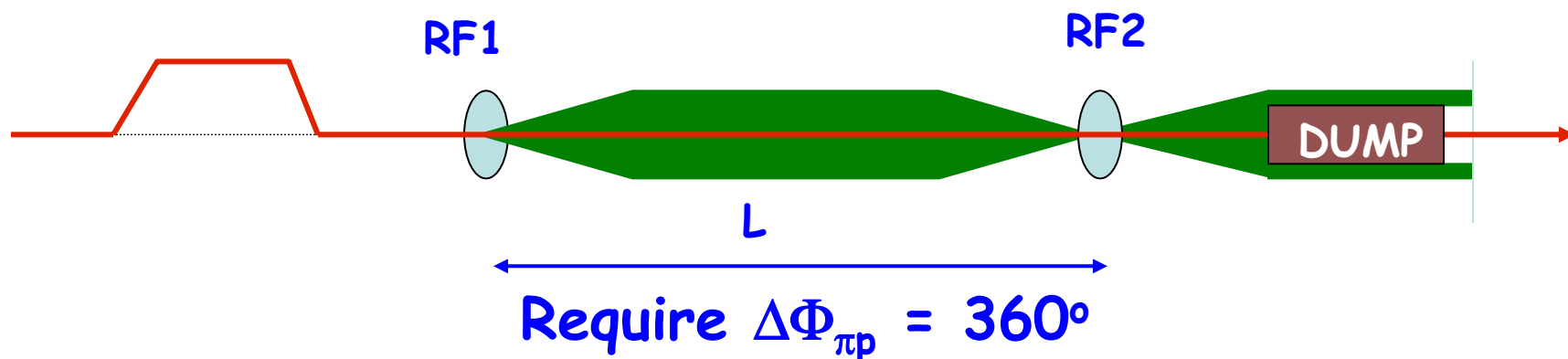

$$\Delta\Phi = 2\pi (L f / c) (\beta_1^{-1} - \beta_2^{-1}) \text{ with } \beta_1^{-1} - \beta_2^{-1} = (m_1^2 - m_2^2) / 2p^2$$



- 1) For same  $\Delta\Phi$ , keep  $L/p^2$  constant, i.e.  $L \sim p^2$ , but decays  $\sim p$
- 2) If phase difference  $\Delta\Phi_{\pi p} = 360^\circ$ , then  $\Delta\Phi_{\pi K} = 93^\circ$ ,  $\Delta\Phi_{\pi e} = 8^\circ$
- 3) Loose this phase advance if  $p$  different from nominal momentum
- 4) The frequency  $f$  is limited by technology and by coherence length to about 6 GHz. If  $L$  limited too, then  $p$  limited (to  $< 50$  GeV in the case of ECN3)



**Expect at most  $2-3 \cdot 10^5$   $K^+$  per burst**

Compare:  $3 \cdot 10^6$   $K^+$ /pulse in 2003 and 2004 !

## Unseparated beam:

### Advantages:

- Can accept larger angles and momentum bite, e.g. few %  $\Delta P$ , few mrad  
Hence acceptance  $\approx$  100 times larger,
- Can go to optimum beam momentum (e.g. 75 GeV/c)
- Beam can be a lot shorter (say 100 m), hence fewer decays before the beginning of the fiducial volume (factor 2-3 more flux!)
- No need to loose good  $K^+$  particles on a beam dump: factor  $\approx$  2 more

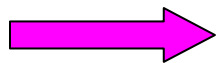

In total few hundred times more K flux compared to RF separated beam !

### Inconveniences:

- Only a small fraction of the beam are  $K^+$  :  
E.g. at 75 GeV/c from 400 GeV/c protons, at production, the hadron content of the beam is the following:

Positive:  $K^+$ : 6.2%,  $\pi^+$ : 71.1%, p: 22.7%

Negative:  $K^-$ : 6.8%,  $\pi^-$ : 90.8%, pbar: 2.4%

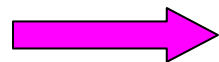

Have to tag  $> 10^9$  particles per spill

## Possible new high-intensity beam for $K^+ \rightarrow \pi^+ \nu \bar{\nu}$ experiment

Beam:	Present K12 (NA48/2)	New HI $K^+$ > 2006	Factor gain wrt 2004
SPS protons per pulse	$1 \times 10^{12}$	$3 \times 10^{12}$	3.0
Duty cycle (s./s.)	4.8 / 16.8		1.0
Beam acceptance H,V (mrad)	$\pm 0.36$	$\pm 2.4, \pm 2.0$	
Solid angle ( $\mu$ sterad)	$\approx 0.40$	$\approx 16$	40
Av. $K^+$ momentum $\langle p_K \rangle$ (GeV/c)	60	75	$K^+ : 1.50$ $\pi^+ : 1.35$ Total : 1.35
Momentum band $\Delta p_K$ (GeV/c)	57 - 63 = 6	73.9-76.1=2.25	$\approx 0.375$
Eff.: ( $\Delta p/p$ in %)	$\pm 5$	$\pm 1.5$	$\approx 0.3$
RMS: ( $\Delta p/p$ in %)	$\approx 4$	$\approx 0.95$	$\approx 0.25$
Beam size (cm)	$\pm 1.5$	$\pm 2.5$	$\approx 2.8$
Area at KABES (cm <sup>2</sup> )	$\approx 7.0$	$\approx 20$	
Divergence: RMS (mrad)	$\approx 0.05$	$\approx 0.1$	$\approx 2$

**PRELIMINARY, WORK IN PROGRESS**

Possible future of experimental areas  
Villars Meeting of SPSC

## Possible new high-intensity K<sup>+</sup> beam for 'NA48/3' - page 2

Beam:	Present K12 (NA48/2)	New HI K <sup>+</sup> > 2006	Factor gain wrt 2004
Decay fid. length (m) <span style="color: green;">(<math>\tau_{K^+}</math>)</span>	50 <span style="color: green;">0.11</span>	50 0.09	0.8
Beam flux/pulse: p ( $\times 10^7$ )	0.86	49	
K <sup>+</sup>	0.31	15	50 (~30)
$\pi^+$	3.32	150	45 (~27)
e <sup>+</sup>	0.95	35	
Total per pulse	5.5	250	~45 (~27)
<span style="color: green;">per Effective spill length (/s)</span>	<span style="color: green;">1.8</span>	80	~45 (~27)
<span style="color: green;">/ ... / cm<sup>2</sup> (KABES) / s</span>	<span style="color: green;">0.25</span>	4	~16 (~10)
Eff. running time / yr (days)	$\frac{1}{2} * 120$	$\frac{2}{3} * 90$	
(pulses)	3.1 $10^5$	3.1 $* 10^5$	1.0
K <sup>+</sup> decays per year inside fiducial length	1.0 $10^{11}$	4 $* 10^{12}$	$\approx 40$

**PRELIMINARY, WORK IN PROGRESS**

Possible future of experimental areas  
Villars Meeting of SPSC

## The GIF Facility in The West Area

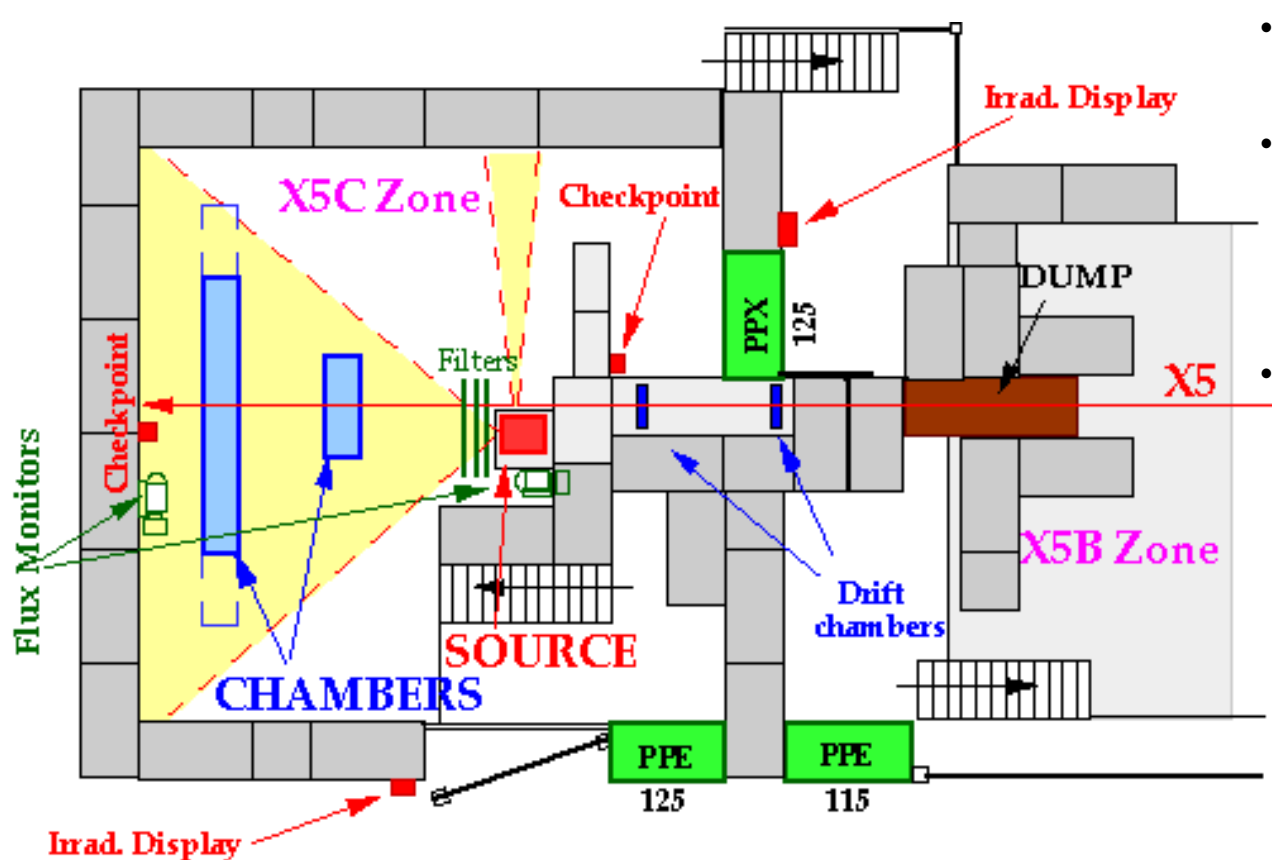

- GIF is located at the end of the X5 beam.
- It consists of a 20 Cu Cesium source, illuminating a large area.
- Muons accompanying the X5 beam are tagged at the GIF entrance by a scintillator counter and two delay wire chambers. A typical muon flux is of the order of  $10^4 \mu$  per spill within  $\varnothing=10$  cm

The GIF facility allows to test the performance (efficiency, resolution,...) of large surface detectors in the presence (or not) of radiation from the source that simulates the radiation during LHC operation.

A system of "filters" allows to modulate the effective strength of the source

# DOSMIX Project

## Dosimetry in mixed radiation fields

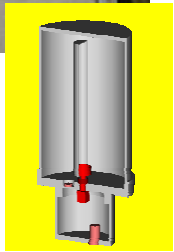
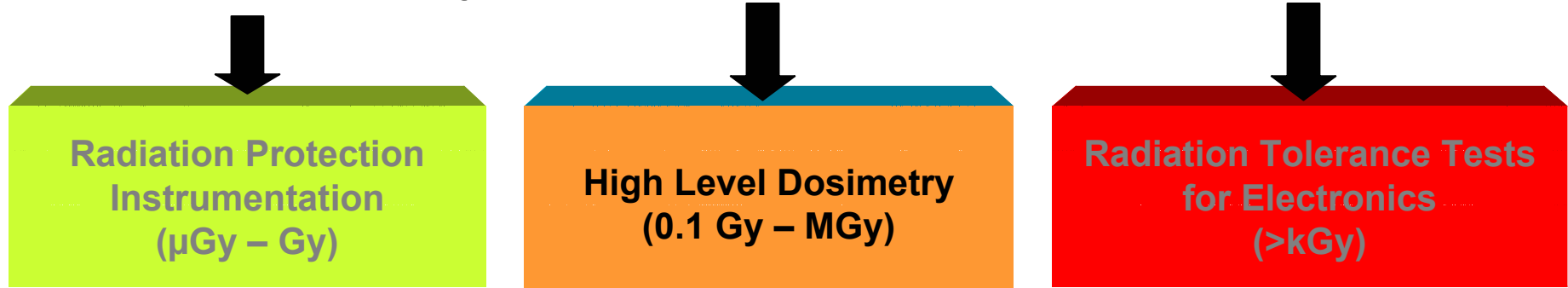

$\mu\text{Gy} - \text{Gy}$

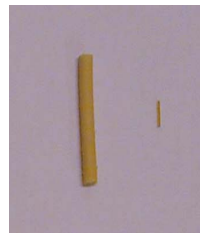

$\text{Gy} - \text{kGy}$

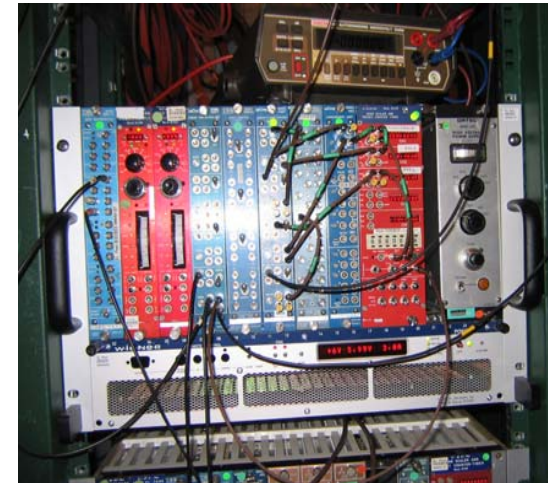

$> \text{kGy}$



# User Community

- CERN\*
- SLAC\*
- NASA\*
- NRPB\*
- JINR
- ENEA
- KEK\*
- PTB\*
- GSI\*
- ... and other external institutes
- ...collaboration with industry



\*: already CERF users

# Experimental requirements

- Hadron beam
  - up to several 100 GeV/c
  - up to  $10^{10}$  protons/SPS cycle
- Beam time
  - 4 – 8 weeks per year as main user
- Space requirements
  - Shielded experimental area: 30 x 15 m<sup>2</sup>
  - Data acquisition room: ~ 30 – 40 m<sup>2</sup>
- Challenge
  - High quality radiation field
  - Controlled and reproducible conditions
  - State-of-the-art
  - Compliant with international standards

