

New e- gun (at CLEAR)

Femtosecond gun from INFN

- Will be installed at CLEAR during 2021
- Possibility of *virtual* and *real* diagnostics
- Initially with Cu cathode, eventually Cs₂Te
- Compatible load-lock system

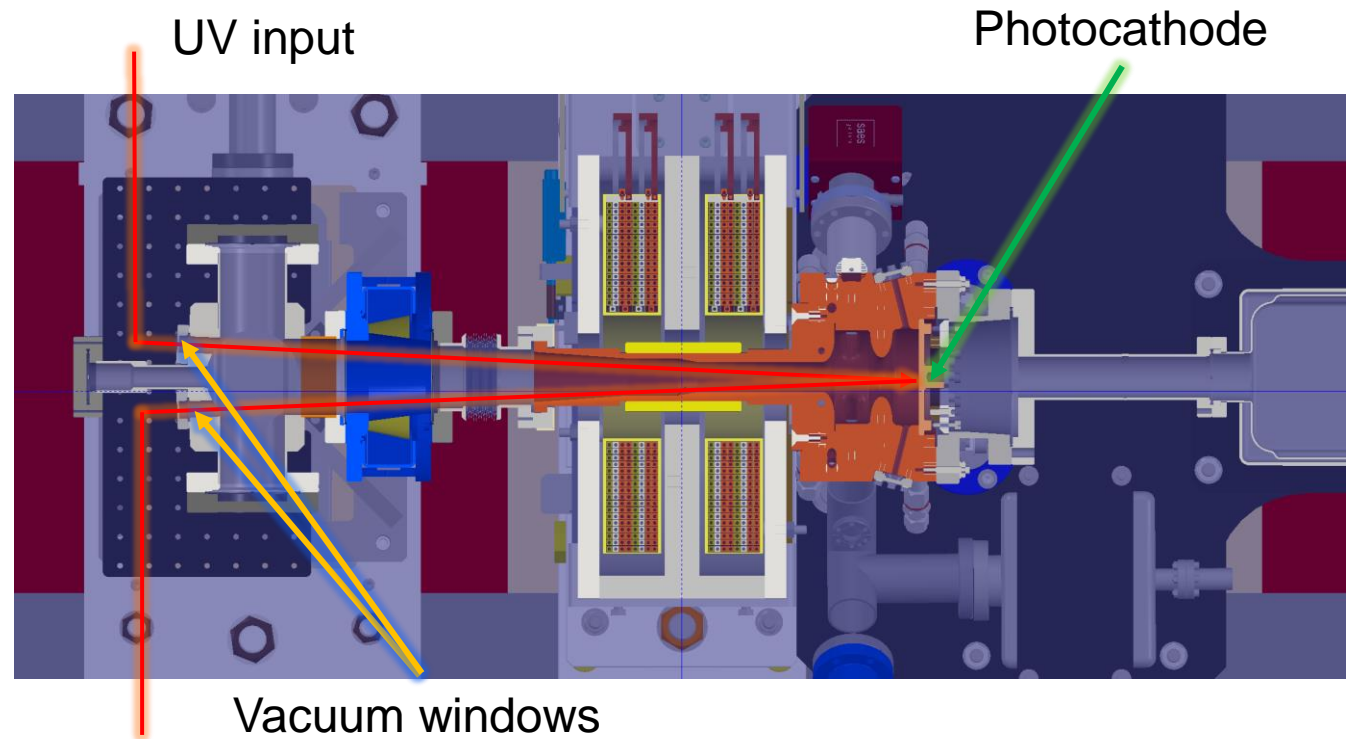
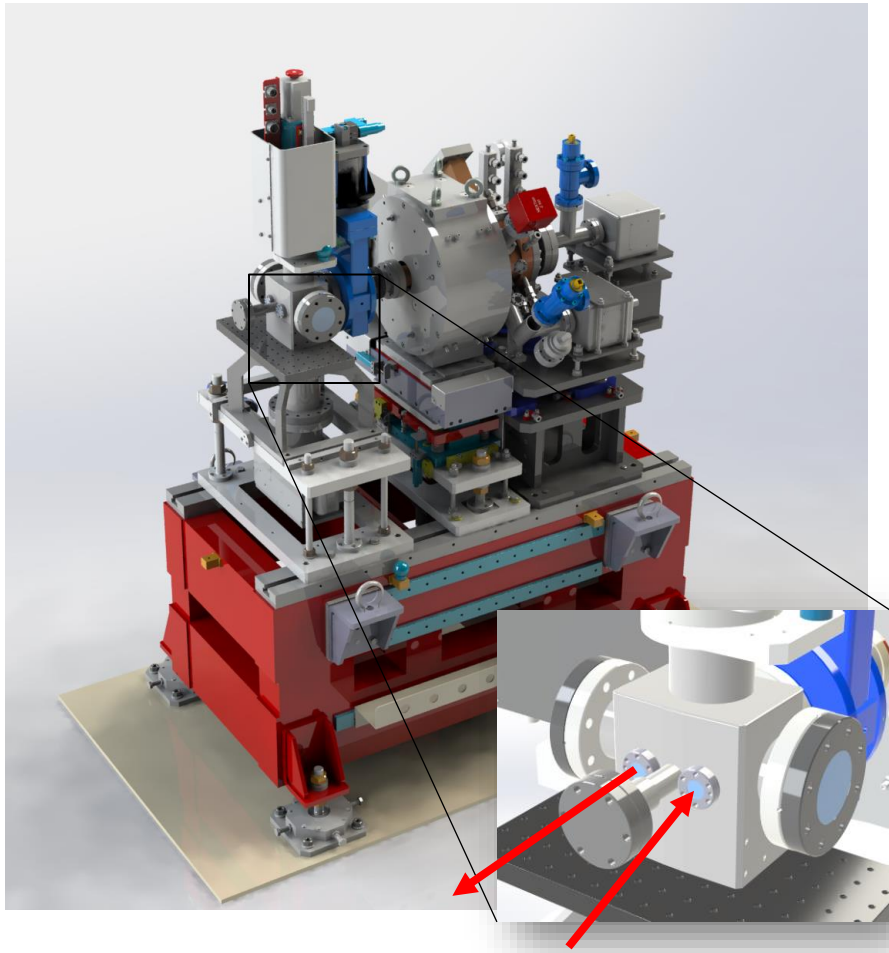

UV reflected beam (diagnostics)

Laser system for fs e- gun (at CLEAR)

- Light Conversion Pharos system already purchased (delivery Dec 2020, integration & commissioning mid-2021)
 - Yb-doped fiber technology
- Designed to operate with both Cu or Cs₂Te
- Variable pulse duration from < 300 fs up to > 5 ps
 - Requires multiple harmonic stages or UV stretcher.
- Synchronizable to RF (3 GHz) reference
- Expected maximum charge production:
 - Cu cathode : ~ 400 pC
 - Cs₂Te : > 1 nC

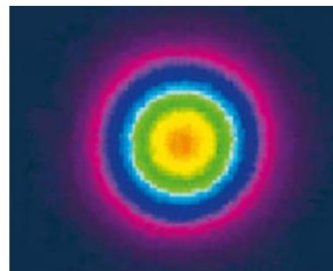
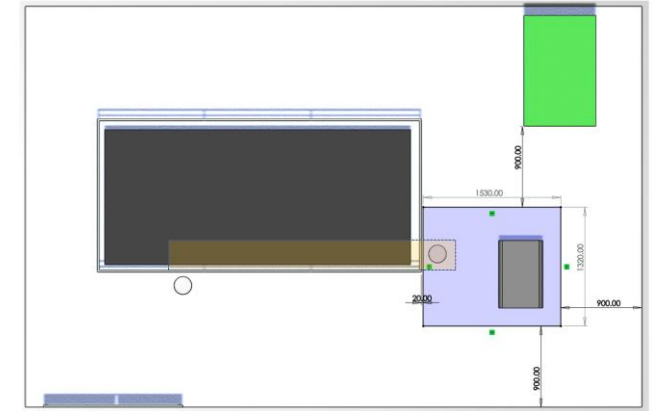

Typical PHAROS far field beam profile at 200 kHz

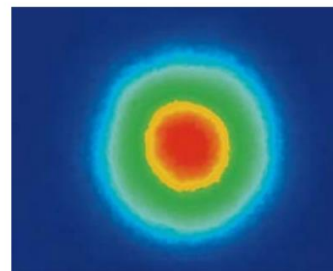

Typical PHAROS near field beam profile at 200 kHz

Pulse energy @ 1030 nm	2 mJ
Pulse energy @ 257 nm	~ 200 uJ *
Repetition rate	0 – 1 MHz
Average Power	20 W
M ²	<1.3
Pulse duration	190 fs – 10 ps

* Depending on pulse duration

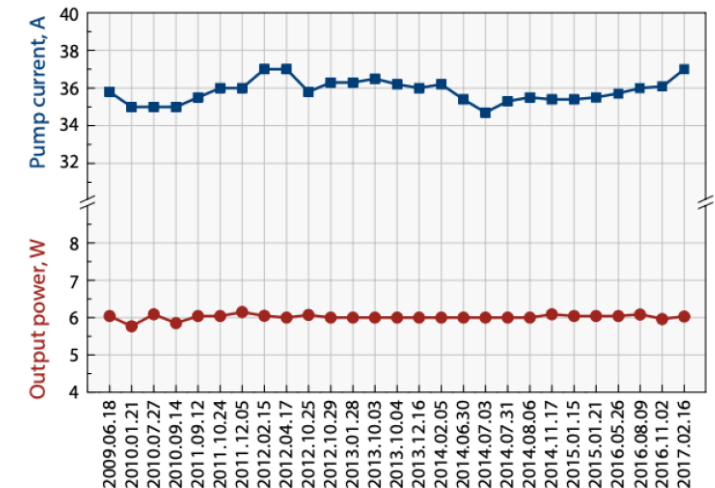

Timing

Bucket control + phase

RF ref (1.5 GHz)

ϕ

Oscillator
77 MHz

SYNC
3 kHz

Regenerative
Amplifier

User input
Single-shot, 10 Hz...

Pulse Picker

To Harmonic stages and
photo-gun

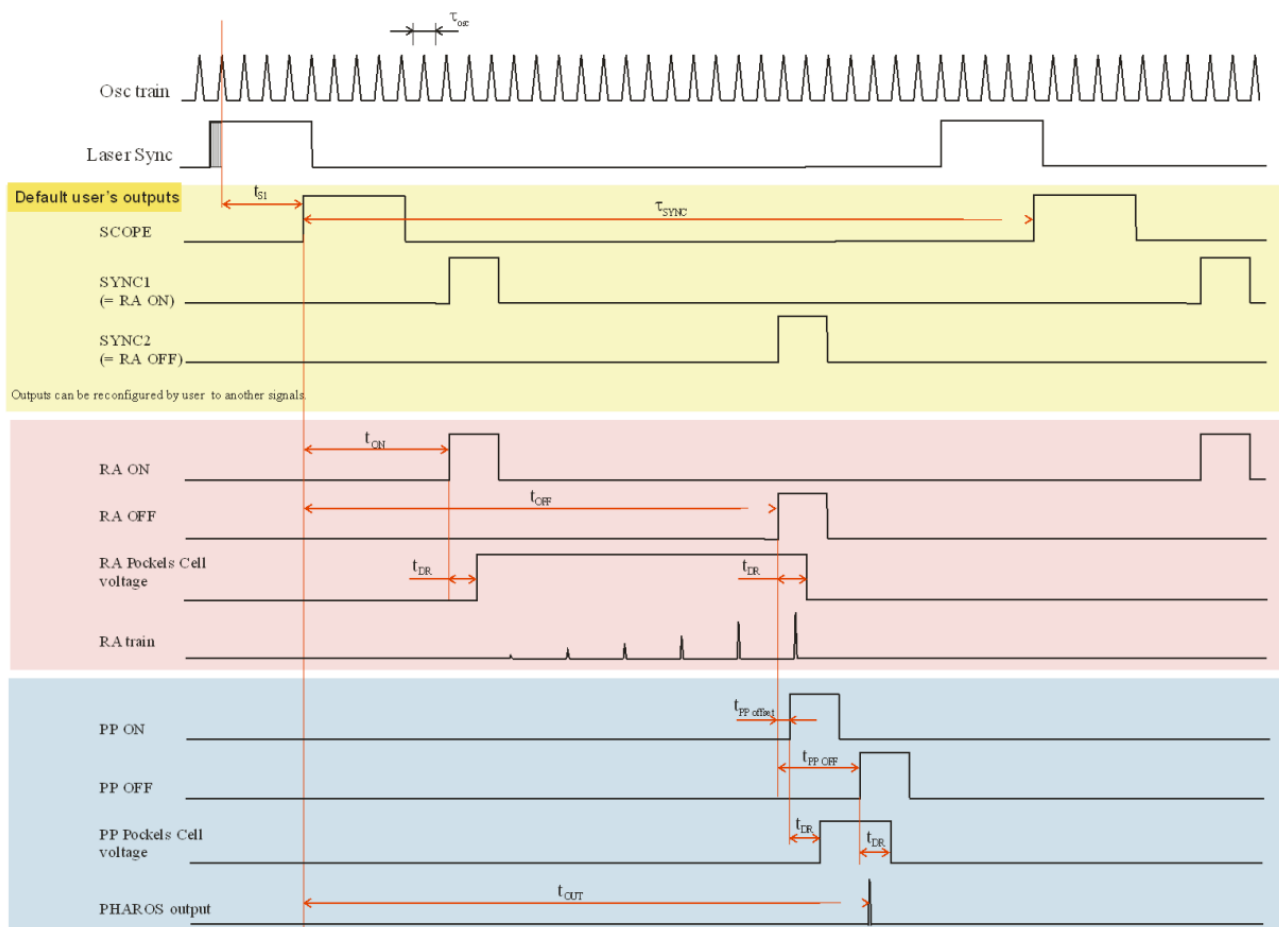

Parameter		Min	Min	Max	Jitter	
Oscillator period	τ_{OSC}		13-14			ns
SYNC period	τ_{SYNC}	1-5*		1000	$1 \tau_{OSC}$	μs
SCOPE to SYNC delay	τ_{S1}		$6 \tau_{OSC}$		$1 \tau_{OSC}$	ns
RA on delay	τ_{ON}	0		45		ns
RA off delay	τ_{OFF}	145		500	0.5 (typical)	ns
Cavity Dumping Time	τ_{CD}	145		500	0.5 (typical)	ns
HV driver delay	τ_{DR}		60			ns
Pulse picker offset	$\tau_{PP \text{ offset}}$	-30		30		ns
PP OFF delay to PP ON	$\tau_{PP \text{ OFF}}$				10	ns
SCOPE, SYNC1, SYNC2 delay to PHAROS output	τ_{OUT}				0.5 (peak to peak at 10^7 pulses)	ns
"Soft Start" time			5			s
Time between RA STOP and Run commands		3				s

Figure 9. Laser timing diagram with reference to optical pulses of OSC and RA

Example:

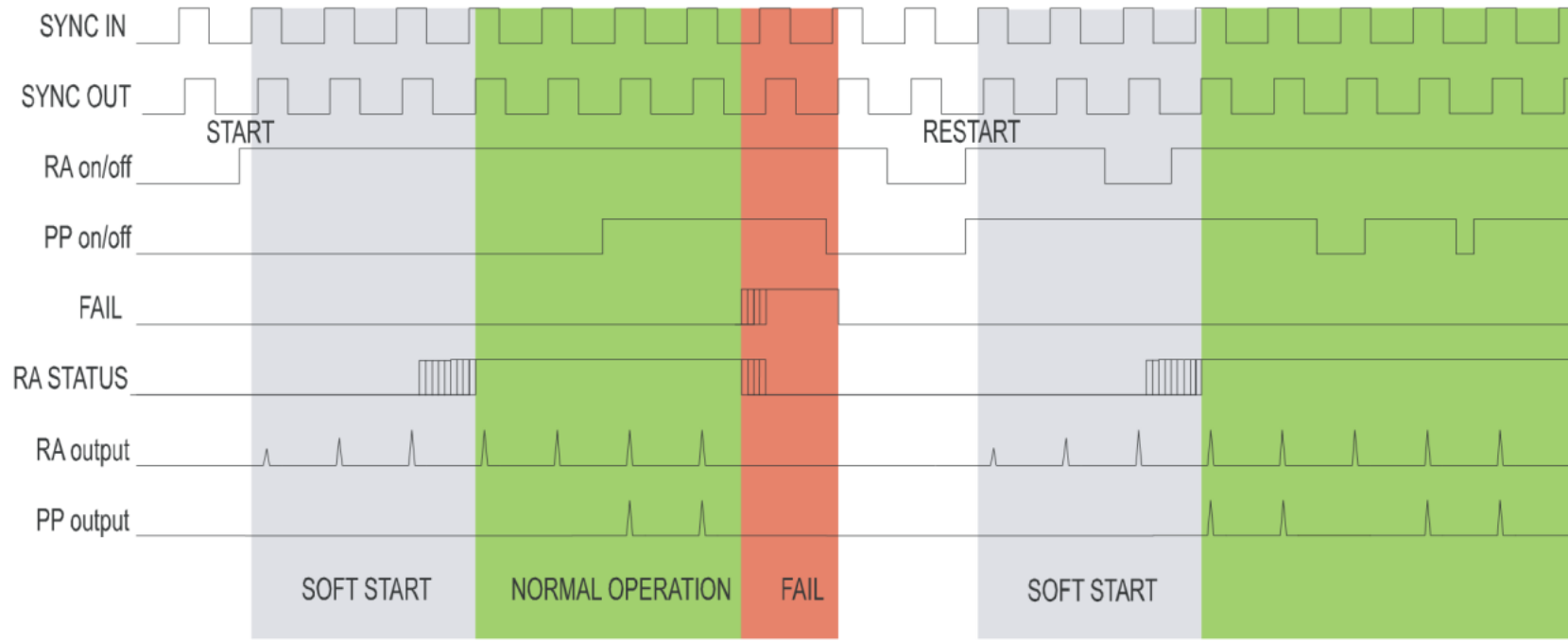
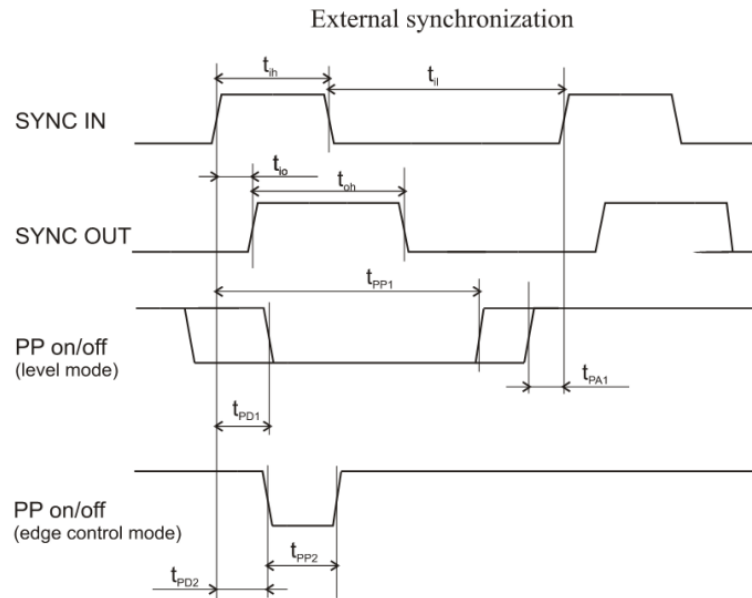
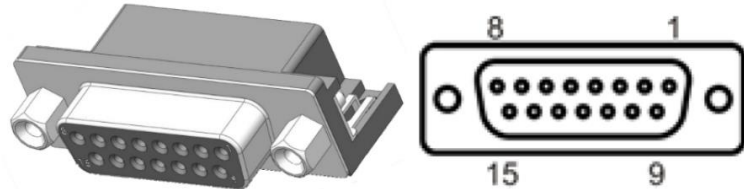

Figure 11. Waveforms for remote control signals and laser output



Parameter	Min	Typical	Max	
Internal synchronization				
SYNC OUT high	τ_p	500		ns
PP on/off signal delay	τ_{pr1}	0	130	ns
PP on/off signal hold	τ_{pp}	50	70	ns
External synchronization				
SYNC IN high	τ_{ih}	100	500	ns
SYNC IN period	$\tau_{il} + \tau_{ih}$	1-5*	1000	μs
SYNC IN to SYNC OUT delay	τ_{io}	100		ns
SYNC OUT high	τ_{oh}	500	τ_{ih} if >500	ns
PP on/off signal delay in level control mode	τ_{PD1}		150	ns
PP on/off signal hold starting from SYNC IN in level control mode	τ_{PP1}	560		ns
PP on/off signal delay in edge control mode	τ_{PD2}	50	100	ns
PP on/off signal hold in edge control mode	τ_{PP2}	50	700	ns

PIN	Name	Dir	Description
			
Type: D-SUB 15 female			
1-7	GND	-	-
8	N.C.	-	Not connected
9	SYNC IN	IN	Input of the external clock for the laser synchronization – initiates <i>sync*</i> of the laser. Input must be stable continuous frequency $f=1-200\text{kHz}$ (or 1 MHz depending on laser configuration). Duration of the high level must be between 100 ns and 500 ns
10	RA on/off	IN	Starts (low level) and stops (high level) RA operation. Stops RA operation starting from the first valid <i>sync*</i> of the laser. Start – initiates “ <i>Soft Start</i> ” of RA (RA STATUS output can be used to monitor when RA is leaving “ <i>Soft Start</i> ” and starts operating in a defined regime)
11	PP on/off	IN	The signal controls the PP (low level – opened, high level - closed). The status is loaded with valid <i>laser sync*</i> transition
12	RA STATUS	OUT	High level indicates that RA is operating in a defined regime (soft start has finished and there are no fails in the system)
13	SYNC OUT	OUT	Output of laser <i>sync*</i> signal triggered by the internal laser oscillator or SYNC IN. In the case of an external clock the pulse duration is the same as the input pulse duration. If SYNC IN is < 500ns then SYNC OUT is extended to ~500 ns. In the case of internal clock SYNC OUT is ~500 ns
14	FAIL	OUT	Indicates fail of the laser (OSC or RA). When Fail is high RA is stopped. When fail returns to low RA on/off rising transition will start RA operation
15	N.C.	-	Not connected

**Laser sync* is an internal synchronization signal in the laser. It can be produced by the internal clock of the laser or external SYNC IN signal.