

Experimental signatures of a new dark matter WIMP

Roland Allen

Department of Physics and Astronomy, Texas A&M University

Prediction: Within the next few years, at least one of the Xe-based direct-detection experiments (XENONnT, LZ, or PandaX) will detect a dark matter particle with a mass of about $70 \text{ GeV}/c^2$.

We estimate the cross-section of the WIMP proposed here to be slightly above 10^{-48} cm^2 . Both XENONnT and LZ anticipate a sensitivity that extends to $1.4 \times 10^{-48} \text{ cm}^2$.

Prediction on a longer time scale: With a creation cross-section of roughly 1 femtobarn, this particle should be observed at the high-luminosity LHC in 12-15 years.

There is already a strong case that it has been detected in the gamma rays observed by Fermi-LAT and the antiprotons observed by AMS-02, for which the analyses are consistent with our predicted mass and annihilation cross-section.

•

Experimental signatures of a new dark matter WIMP

Roland Allen

Department of Physics and Astronomy, Texas A&M University

Prediction: Within the next few years, at least one of the Xe-based direct-detection experiments (XENONnT, LZ, or PandaX) will detect a dark matter particle with a mass of about $70 \text{ GeV}/c^2$.

We estimate the cross-section of the WIMP proposed here to be slightly above 10^{-48} cm^2 . Both XENONnT and LZ anticipate a sensitivity that extends to $1.4 \times 10^{-48} \text{ cm}^2$.

Prediction on a longer time scale: With a creation cross-section of roughly 1 femtobarn, this particle should be observed at the high-luminosity LHC in 12-15 years.

There is already a strong case that it has been detected in the gamma rays observed by Fermi-LAT and the antiprotons observed by AMS-02, for which the analyses are consistent with our predicted mass and annihilation cross-section.

The present picture results from a fundamental theory: [arXiv:1101.0586](https://arxiv.org/abs/1101.0586) [hep-th] and currently under review.

The fields associated with the dark matter candidate and related particles are Majorana-like bosonic fields with the form

$$\Phi_S = \frac{1}{\sqrt{2}} \begin{pmatrix} \Phi_S \\ \Phi_S^c \end{pmatrix}$$

which ultimately results in only second-order gauge couplings for the physical higgs fields h^0 (which are 1-component, real, scalar boson fields) :

$$\mathcal{L}_0^Z = -\frac{g_Z^2}{4} h^{0\dagger} Z^\mu Z_\mu h^0 \quad , \quad \mathcal{L}_0^W = -\frac{g^2}{2} h^{0\dagger} W^{\mu+} W_\mu h^0$$

The phenomenologies are very different for the various other -- *ad hoc* -- extended Higgs models which have been proposed.

In the inert doublet model, for example, the additional doublet field, which is odd under a postulated new Z_2 symmetry, has the form

$$\begin{pmatrix} H_I^+ \\ \frac{1}{\sqrt{2}} (H_I^0 + iA_I^0) \end{pmatrix}$$

with first-order couplings of the dark-matter candidate H_I^0 to the other two (neutral and charged) particles.

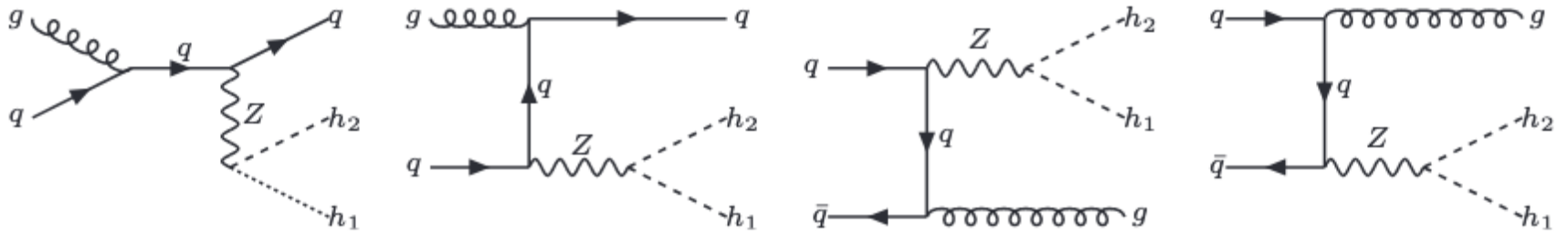

A. Belyaev et al., Phys. Rev. D 99, 015011 (2019), arXiv:1809.00933 [hep-ph].

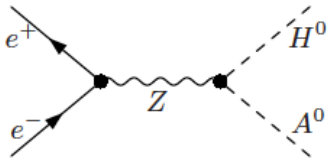

(a)

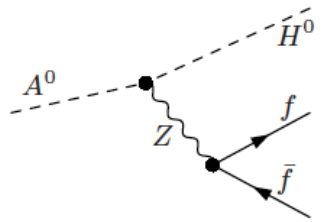

(b)

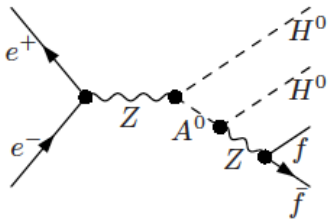

(c)

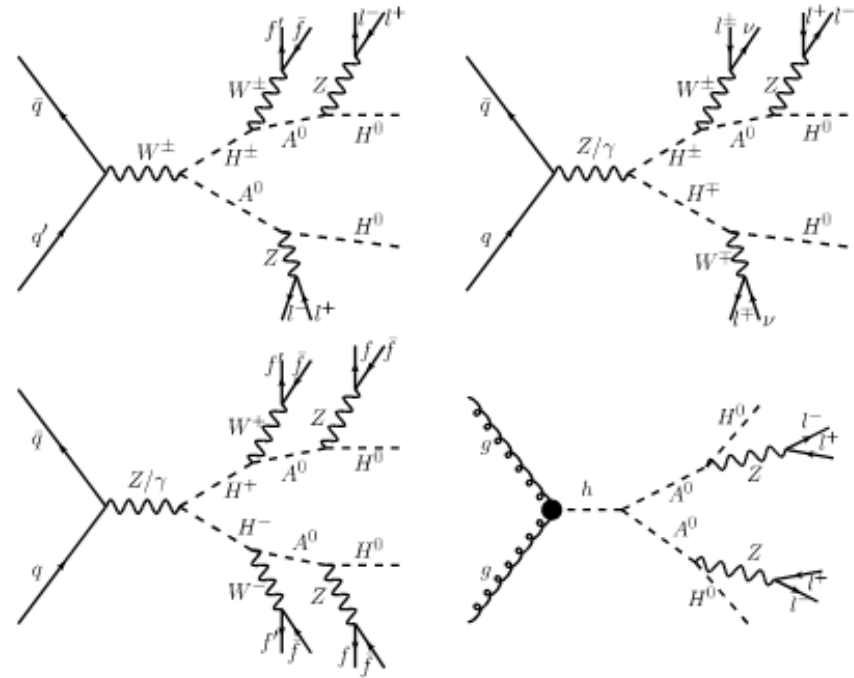

M. Gustafsson, et al., Phys. Rev. D 86, 075019 (2012), arXiv:1206.6316 [hep-ph].

Some IDM processes that will not be observed in the present picture – different phenomenology.

E. Lundström et al., Phys. Rev. D 79, 035013 (2009), arXiv:0810.3924 [hep-ph].

We have called the particles of the new kind proposed here “higgsons” [3], represented by h , to distinguish them from Higgs bosons H and the higgsinos \tilde{h} of supersymmetry. The lightest neutral particles in these three groups are h^0 , H^0 , and \tilde{h}^0 .

[1] Reagan Thornberry, Maxwell Throm, John Killough, Dylan Blend, Michael Erickson, Brian Sun, Brett Bays, Gabe Frohaug, and Roland E. Allen, “Experimental signatures of a new dark matter WIMP”, EPL (European Physics Letters), 34, 49001 (2021), arXiv:2104.11715 [hep-ph].

[2] Caden LaFontaine, Bailey Tallman, Spencer Ellis, Trevor Croteau, Brandon Torres, Sabrina Hernandez, Diego Cristancho Guerrero, Jessica Jaksik, Drue Lubanski, and Roland E. Allen, “A Dark Matter WIMP That Can Be Detected and Definitively Identified with Currently Planned Experiments”, Universe 7, 270 (2021), arXiv:2107.14390 [hep-ph].

[1] Bailey Tallman, Alexandra Boone, Caden LaFontaine, Trevor Croteau, Quinn Ballard, Sabrina Hernandez, Spencer Ellis, Adhithya Vijayakumar, Fiona Lopez, Samuel Apata, Jehu Martinez, and Roland Allen, “Indirect detection, direct detection, and collider detection cross-sections for a 70 GeV dark matter WIMP”, Proceedings of Science (in press) [proceedings of the 41st International Conference on High Energy Physics, ICHEP 2022], arXiv:2210.05380 [hep-ph].

[1] Bailey Tallman, Alexandra Boone, Adhithya Vijayakumar, Fiona Lopez, Samuel Apata, Jehu Martinez, and Roland Allen, “Potential for definitive discovery of a 70 GeV dark matter WIMP with only second-order gauge couplings”, submitted to Letters in High Energy Physics, arXiv:2210.15019 [hep-ph].

If the mass of h^0 were above the mass of a W boson, annihilation into real W and Z pairs would have a large cross-section, and result in a severe underabundance of dark matter.

If the mass of h^0 were far below the mass of a W boson, annihilation into a real W or Z and a virtual one would have a small cross-section, and result in a severe overabundance of dark matter.

But for a mass of 70 GeV, there is resonance-like behavior for the W boson propagator, and the relic abundance is in agreement with observation.

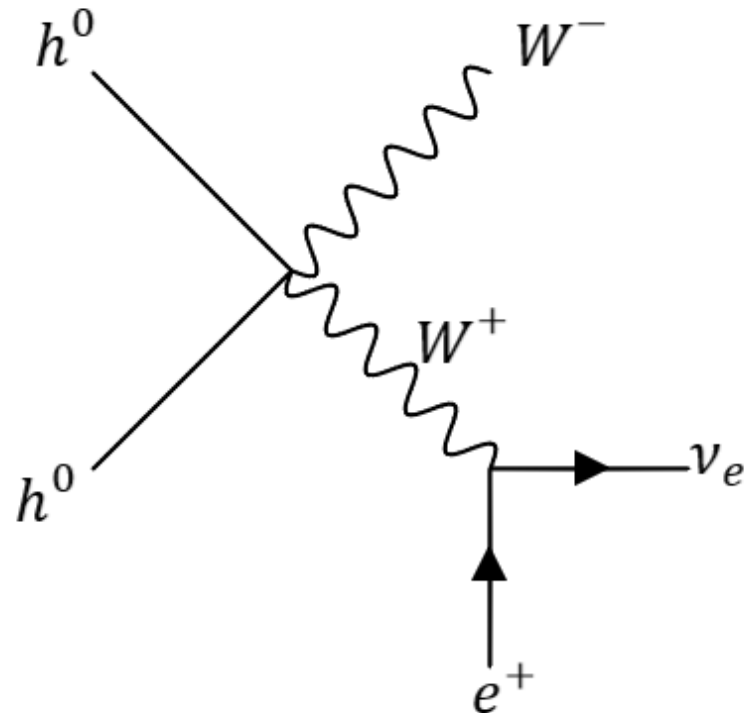

Three of the space-based studies of astrophysical phenomena:

Fermi-LAT



AMS-02



Planck

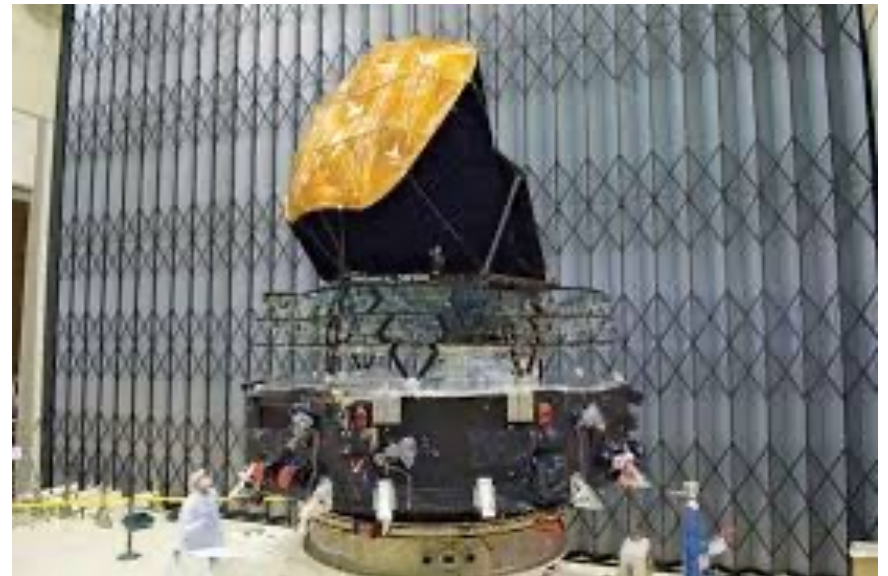

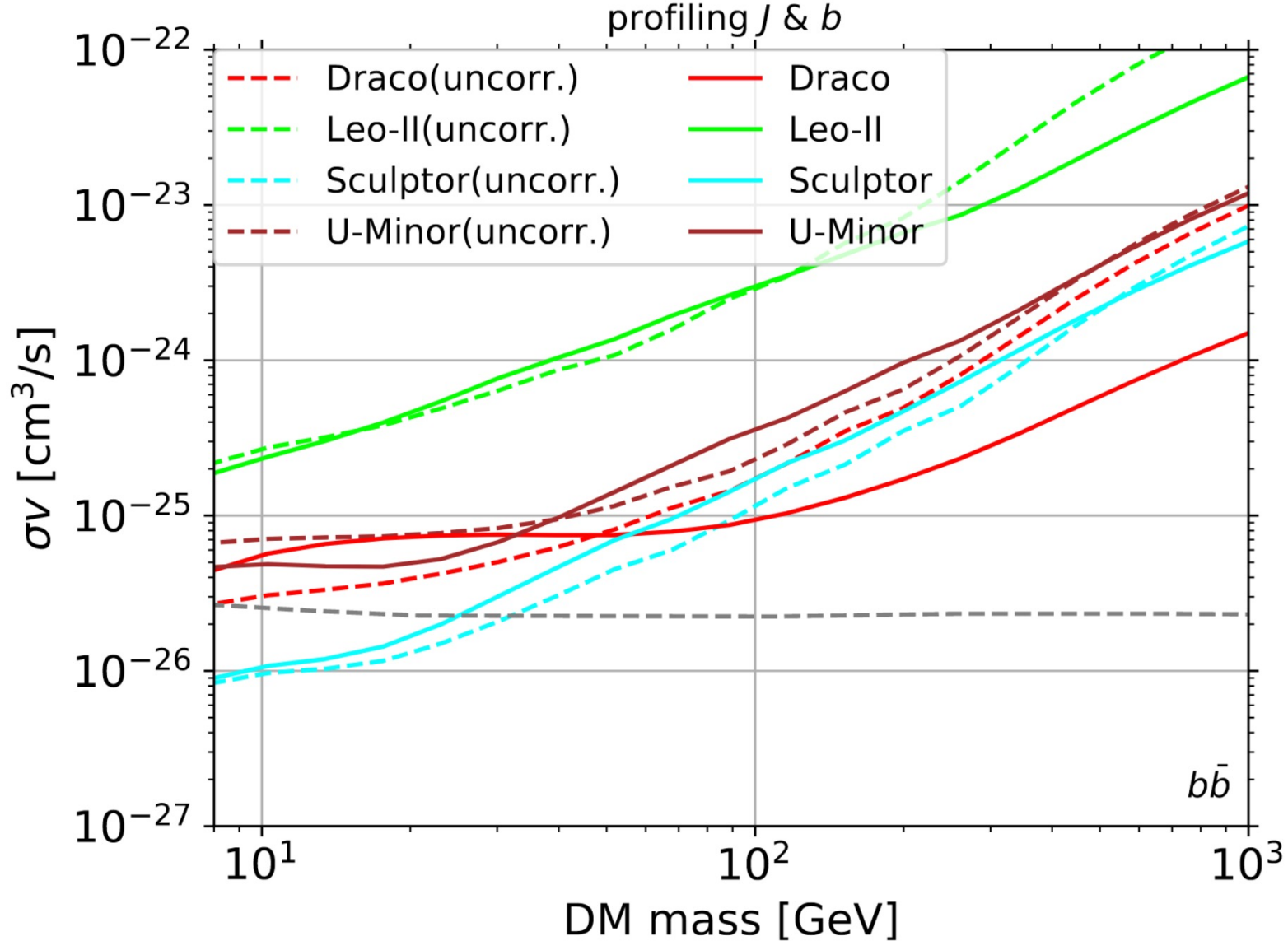

Upper limits on present annihilation cross-sections imposed by dwarf spheroidal galaxies, from A. Alvarez, F. Calore, A. Genina, J. Read, P. Dario Serpico and B. Zaldivar, J. Cosmol. Astropart. Phys. 09, 004 (2020), arXiv:2002.01229 [astro-ph.HE].

Our prediction (at 70 GeV): $\langle \sigma_{ann} v \rangle = 1.19 \times 10^{-26} \text{ cm}^3/\text{s}$

Christopher Karwin, Simona Murgia, Tim M. P. Tait, Troy A. Porter, and Philip Tanedo, Phys. Rev. D 95, 103005 (2017), arXiv:1612.05687 [hep-ph]:

“The center of the Milky Way is predicted to be the brightest region of γ -rays generated by self-annihilating dark matter particles. Excess emission about the Galactic center above predictions made for standard astrophysical processes has been observed in γ -ray data collected by the Fermi Large Area Telescope.

It is well described by the square of a Navarro, Frenk, and White dark matter density distribution. Although other interpretations for the excess are plausible, the possibility that it arises from annihilating dark matter is valid.”

“... its spectral characteristics favor a dark matter particle with a mass in the range approximately from 50 to 190 (10 to 90) GeV ... for pseudoscalar (vector) interactions.”

Rebecca K. Leane and Tracy R. Slatyer, “Revival of the Dark Matter Hypothesis for the Galactic Center Gamma-Ray Excess”, Phys. Rev. Lett. 123, 241101 (2019), arXiv:1904.08430 [astro-ph.HE]:

“... we conclude that dark matter may provide a dominant contribution to the GCE after all.”

Intriguing results from two careful analyses of AMS-02 observations of antiprotons and Fermi-LAT observations of gamma rays from the Galactic Center

Ilias Cholis, Tim Linden, and Dan Hooper, “A Robust Excess in the Cosmic-Ray Antiproton Spectrum: Implications for Annihilating Dark Matter”, Phys. Rev. D 99, 103026 (2019); arXiv:1903.02549 [astro-ph.HE]:

“This excess is well fit by annihilating dark matter particles, with a mass and cross section in the range of $m_\chi \approx 46\text{-}94$ GeV ...”

“... it is particularly intriguing that the range of dark matter models that can accommodate the antiproton excess is very similar to those which could generate the excess of GeV-scale gamma rays observed from the Galactic Center...”

Alessandro Cuoco, Jan Heisig, Lukas Klamt, Michael Korsmeier, and Michael Krämer, “Scrutinizing the evidence for dark matter in cosmic-ray antiprotons”, Phys. Rev. D 99, 103026 (2019); arXiv:1903.01472 [astro-ph.HE]:

“... strong limits on heavy DM have been derived from global CR fits. At the same time, the data have also revealed a tentative signal of DM, corresponding to a DM mass of around 40–130 GeV ...”

“This signal, if confirmed, is compatible with a DM interpretation of the Galactic center γ -ray excess ...”

The inferred masses and cross-sections in the analyses are consistent with those for the present dark matter candidate – e.g., a mass ~ 70 GeV/c².

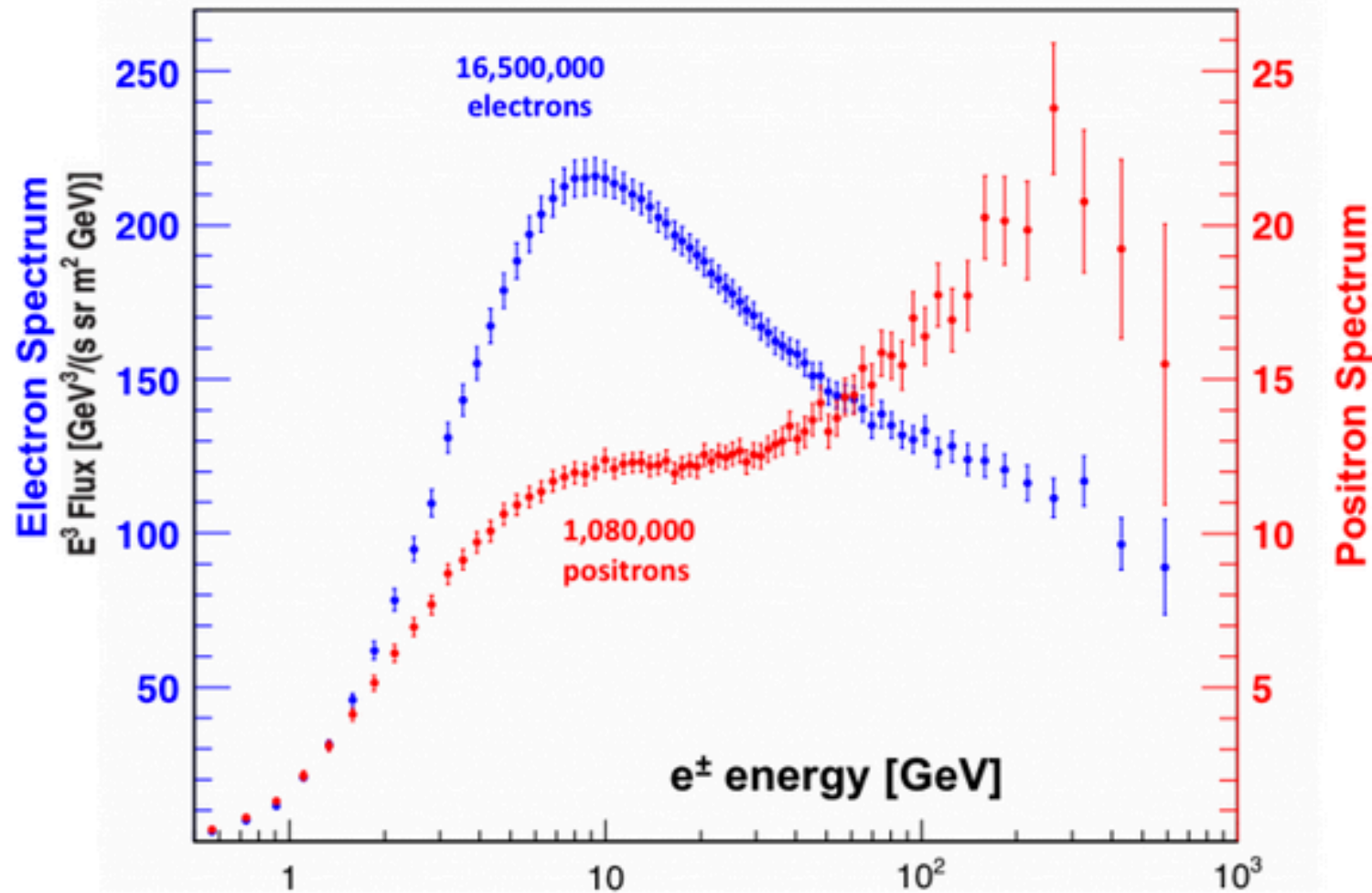

AMS has observed that the **electron flux** and **positron flux** display different behaviors both in their magnitude and in their energy dependence. **But the dark matter annihilation interpretation is now disconfirmed by Planck.**

<http://www.ams02.org/2016/12/the-first-five-years-of-the-alpha-magnetic-spectrometer-on-the-international-space-station/>

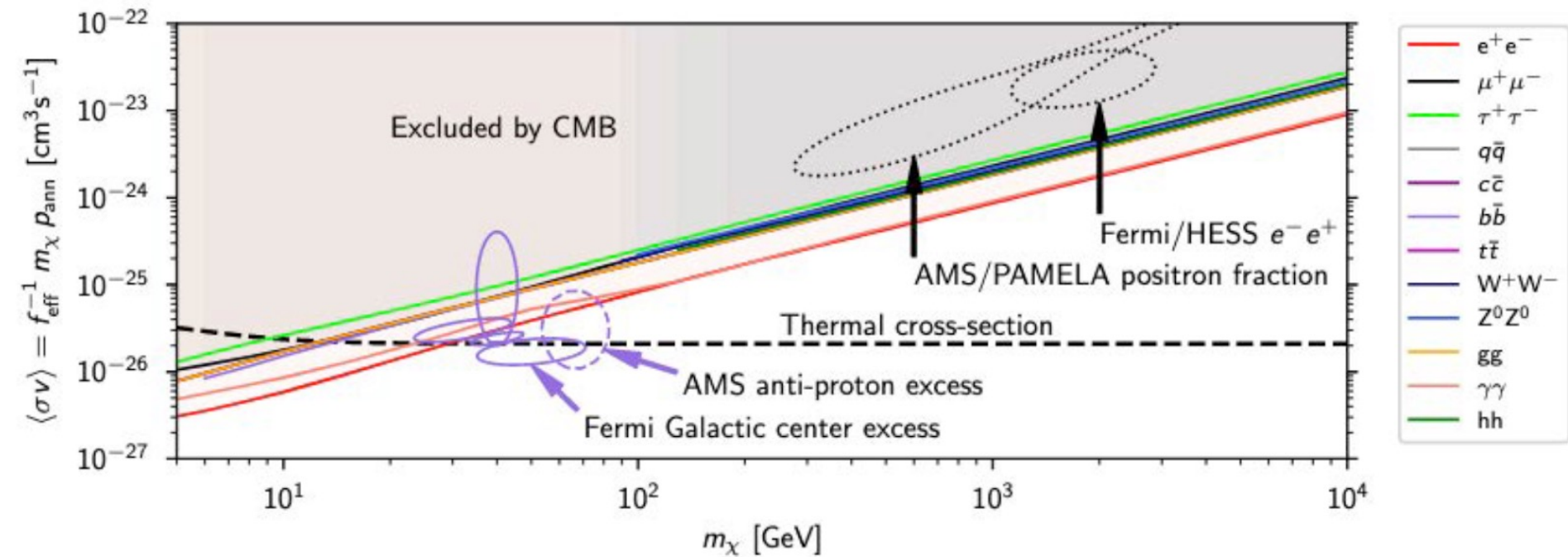

“*Planck* 2018 constraints on DM mass and annihilation cross-section. Solid straight lines show joint CMB constraints on several annihilation channels (plotted using different colours) ... We also show the 2σ preferred region suggested by the AMS proton excess (dashed ellipse) and the Fermi Galactic centre excess according to four possible models with references given in the text (solid ellipses) ... We additionally show the 2σ preferred region suggested by the AMS/PAMELA positron fraction and Fermi/H.E.S.S. electron and positron fluxes ... Assuming a standard WIMP-decoupling scenario, the correct value of the relic DM abundance is obtained for a ‘thermal cross-section’ given as a function of the mass by the black dashed line.”

“CMB anisotropies are sensitive to energy injection in the intergalactic medium that could be a consequence, for example, of dark-matter (DM) annihilation ... The current CMB sensitivity to the annihilation cross section of weakly-interactive massive particles (WIMPs) is competitive with and complementary to that of indirect DM search experiments.”

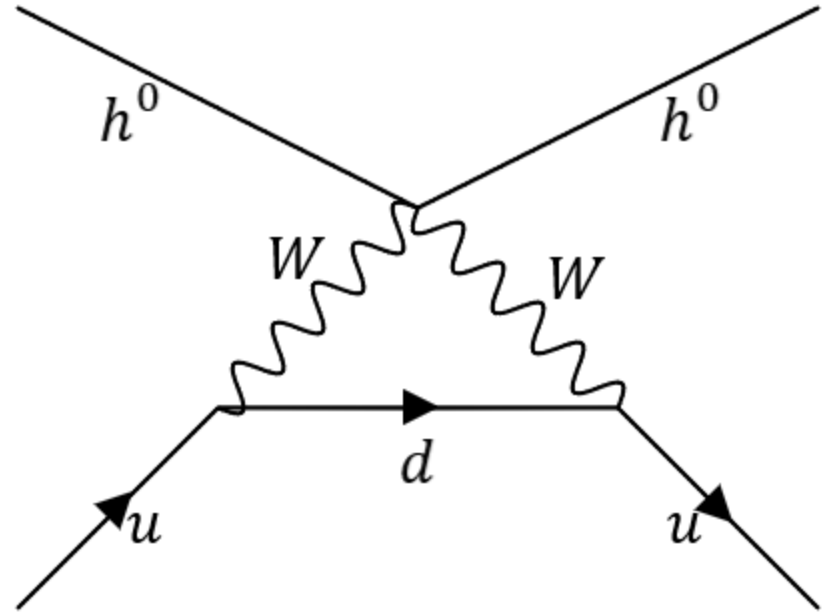
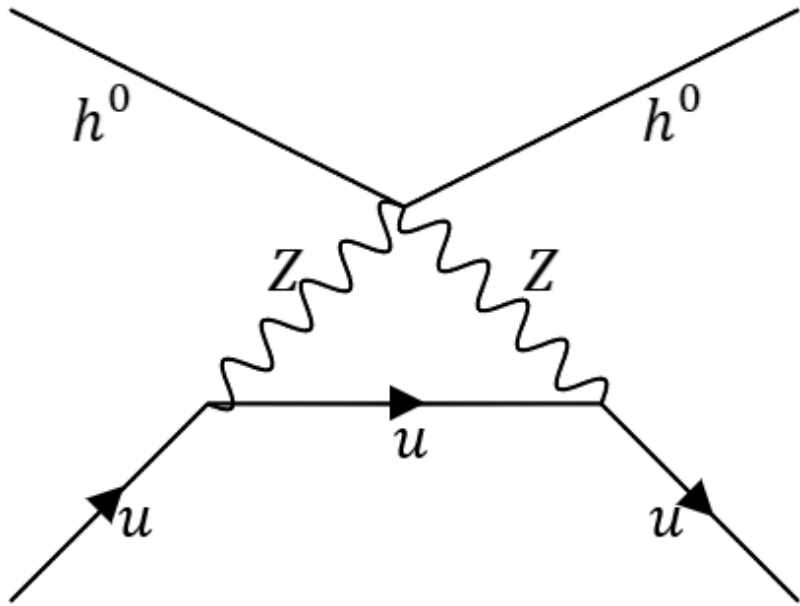

These gauge-mediated one-loop interactions appear to be the best prospect for direct detection, with cross-section slightly above 10^{-48} cm².

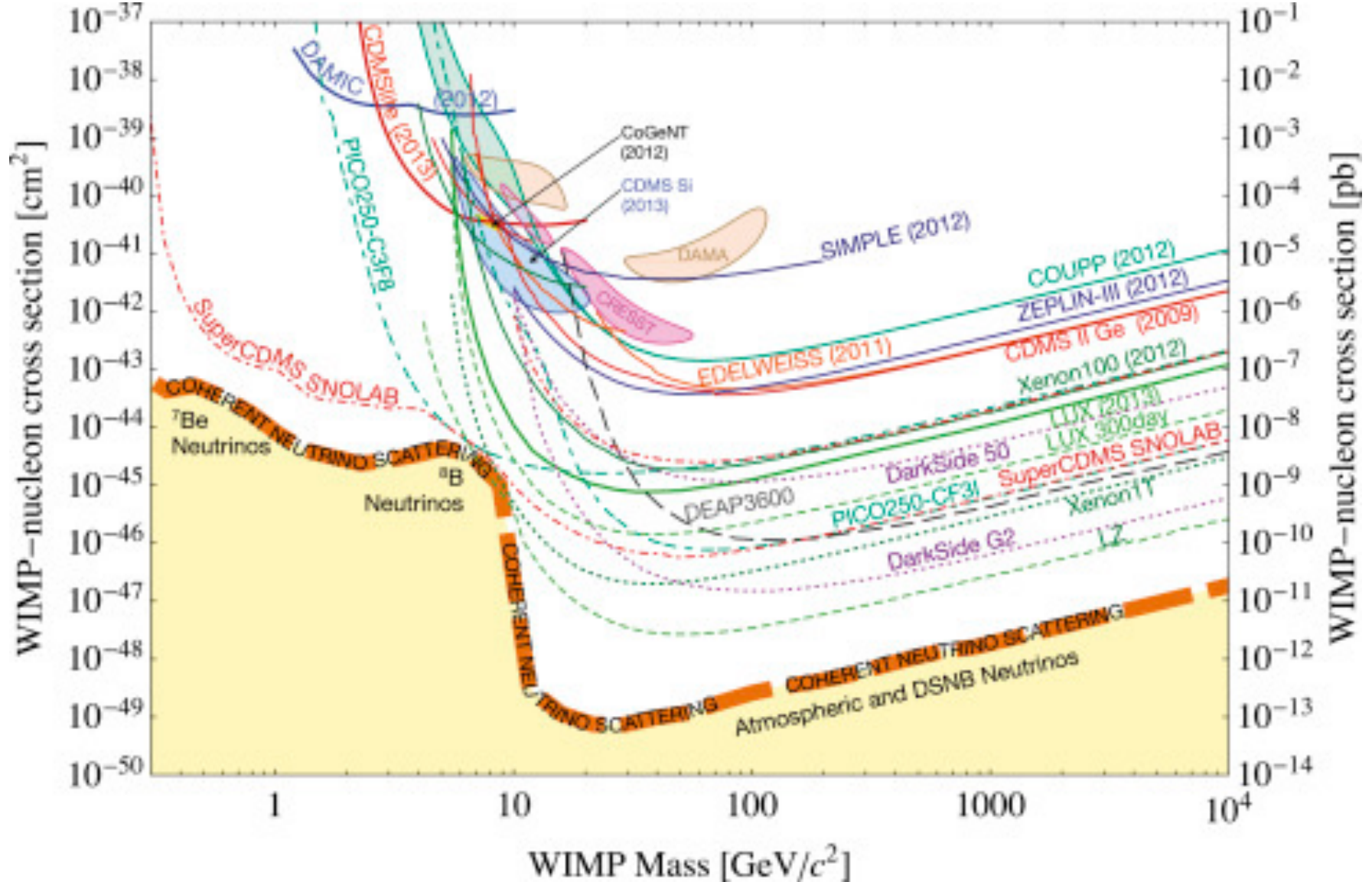

Again: A cross-section for direct detection slightly above 10^{-48} cm^2 at $70 \text{ GeV}/c^2$ is above the neutrino floor and is accessible to LZ, Xenon nT, and PandaX.

Credit -- J. Billard, L. Strigari, E. Figueroa-Feliciano, "Implication of neutrino backgrounds on the reach of next generation dark matter direct detection experiments", Phys. Rev. D, 89, 023524 (2014), [arXiv:1307.5458](https://arxiv.org/abs/1307.5458), <https://doi.org/10.1016/j.dark.2014.10.005>.

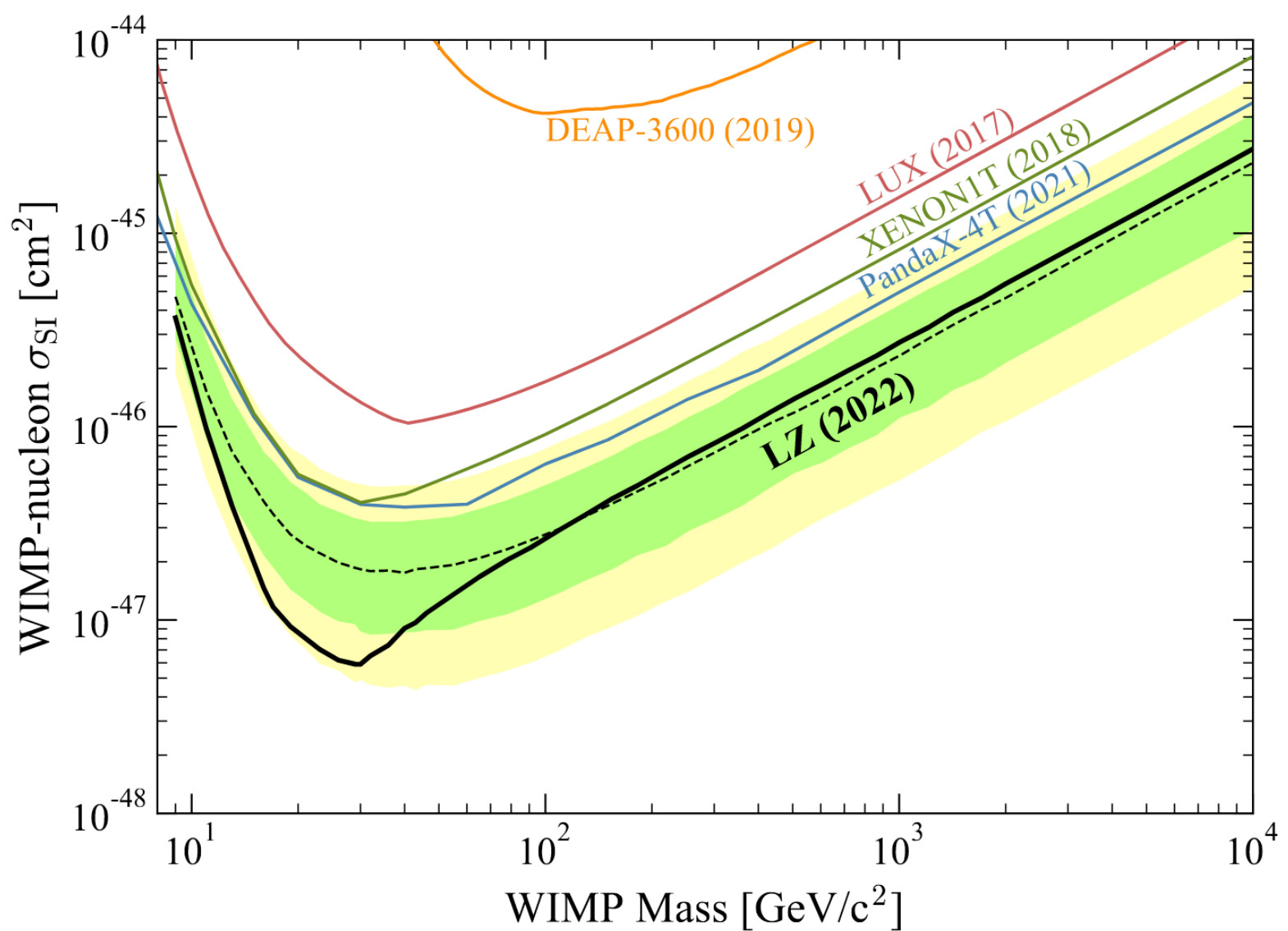

Reach of LZ in July 2022, from J. Aalbers et al. [LUX-ZEPLIN (LZ) Collaboration], "First Dark Matter Search Results from the LUX-ZEPLIN (LZ) Experiment", arXiv:2207.03764 [hep-ex].

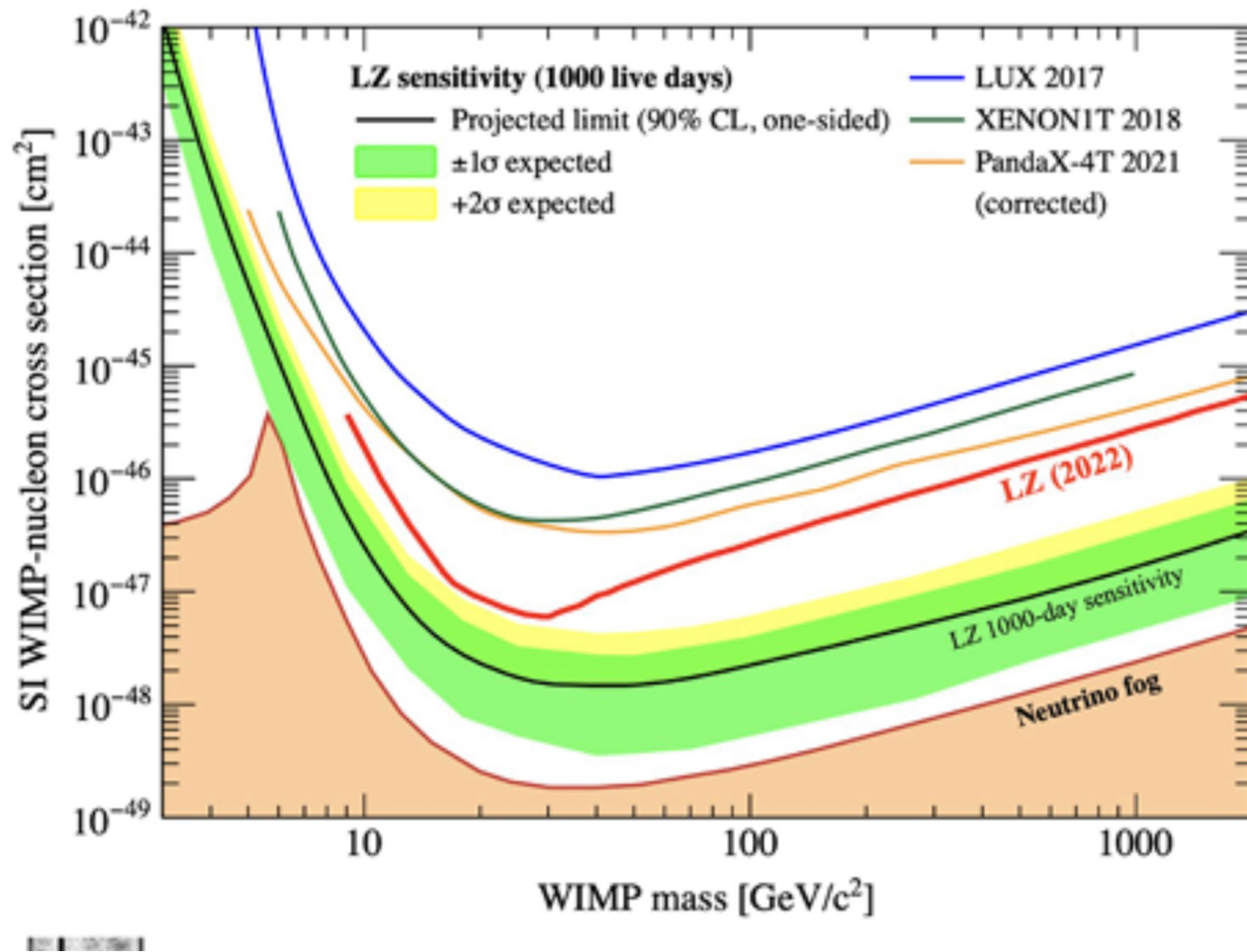

From Kelly Stifter [on behalf of the LZ collaboration], "First dark matter search results from the LUX-ZEPLIN (LZ) experiment", talk at International Conference on Neutrinos and Dark Matter (NuDM-2022), September 25-28, 2022, Sharm El-Sheikh, Egypt.

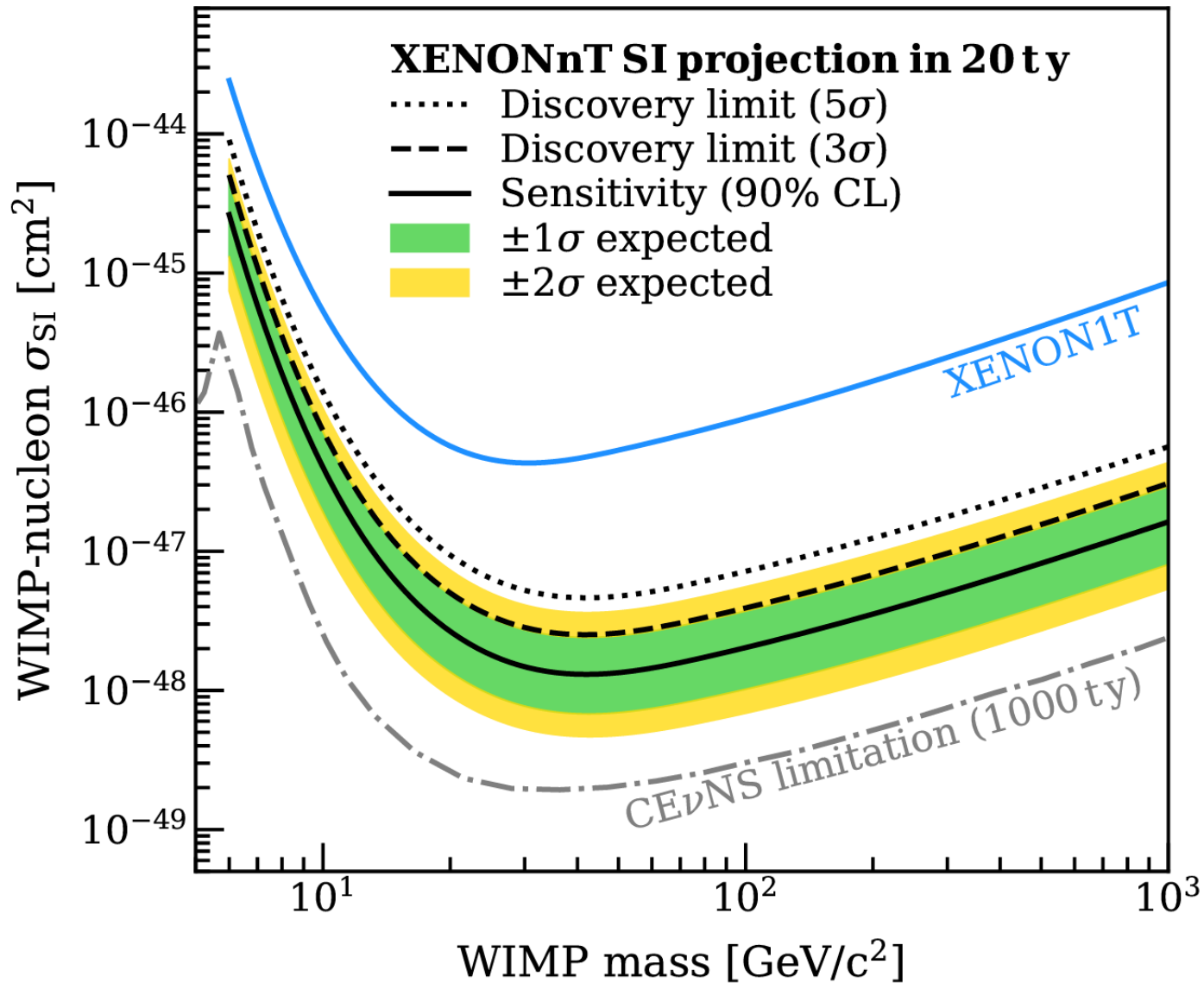

From E. Aprile et al., "Projected WIMP Sensitivity of the XENONnT Dark Matter Experiment", JCAP11, 031 (2020).

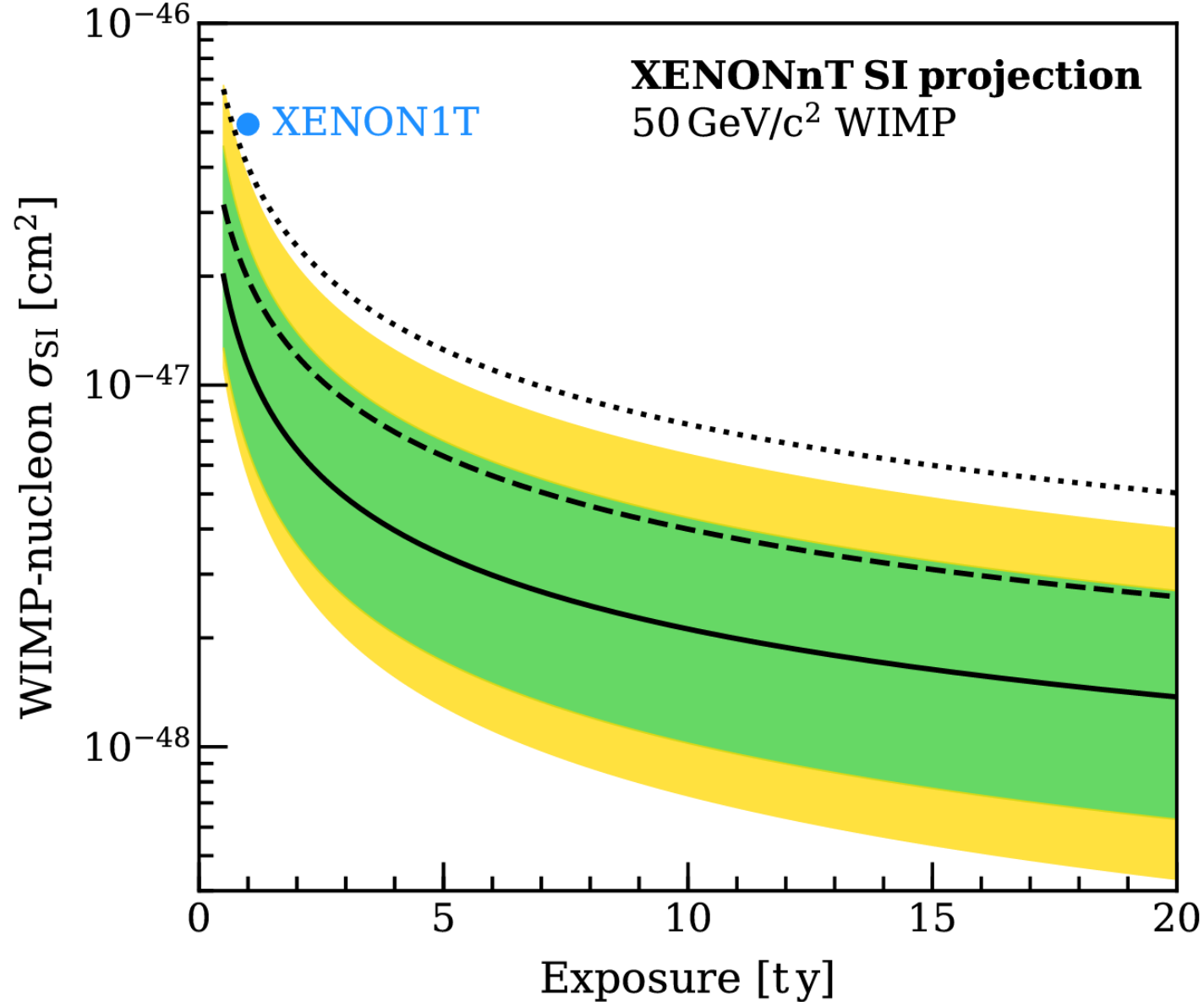

From E. Aprile et al., "Projected WIMP Sensitivity of the XENONnT Dark Matter Experiment", JCAP11, 031 (2020).

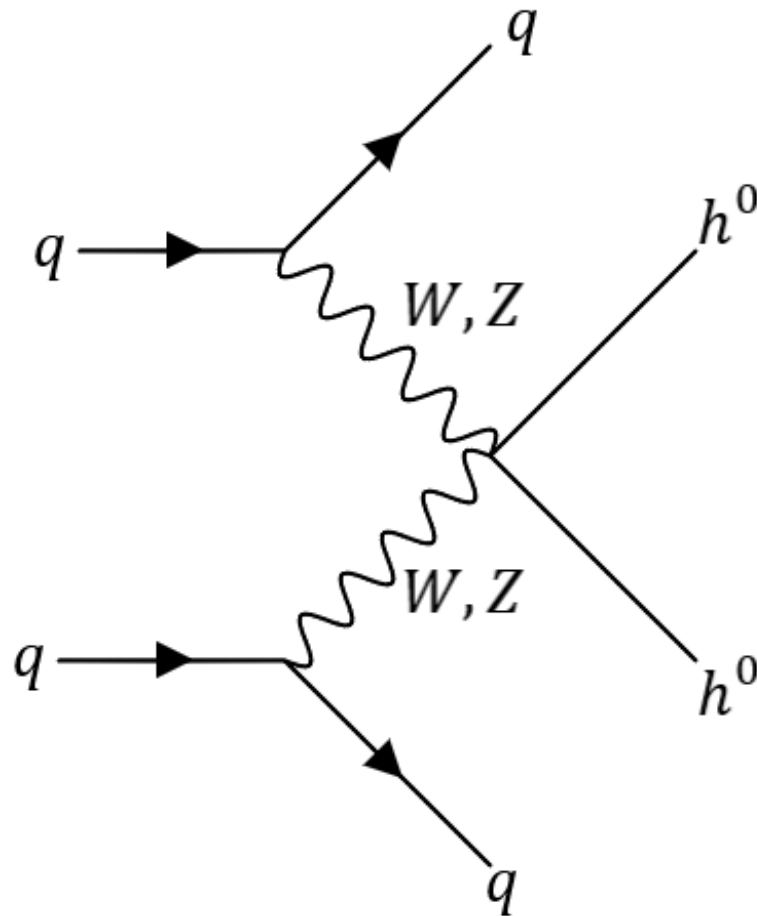

Vector boson fusion appears to be the best prospect for collider detection, with a cross-section of only ~ 1 fb, but possibly within reach of the high-luminosity LHC if it can attain 3000 fb^{-1} . The signature is $\gtrsim 140$ GeV of missing energy and two jets.

The present scenario is consistent with, and to some extent stimulated by, the successes of the Large Hadron Collider – in particular the discovery of the Higgs boson.

In the present theory, there are two kinds of scalar fields and particles that are formed by the combination of more primitive spin ½ fields.

The Higgs/amplitude modes are formed from two fields with the same quantum numbers and opposite spin:

$$\tilde{\Phi}_R = \begin{pmatrix} \tilde{\Phi}_r \\ \tilde{\Phi}_{r'} \end{pmatrix}$$

They are somewhat analogous to the Higgs/amplitude modes observed in superconductors: P. B. Littlewood and C. M. Varma, “Amplitude collective modes in superconductors and their coupling to charge density waves”, Phys. Rev. B. 26, 4883 (1982).

The higgson fields are formed from two fields with opposite quantum numbers:

$$\Phi_S = \frac{1}{\sqrt{2}} \begin{pmatrix} \Phi_s \\ \Phi_s^c \end{pmatrix}$$

The history of spin 1/2 fermions begins with the discovery of the electron in 1897 by J. J. Thomson.

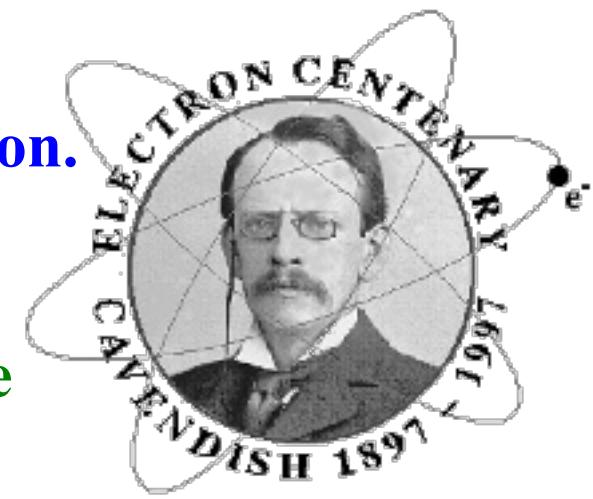

The history of spin 1 gauge bosons begins with the 1905 paper of Einstein which introduced the photon.

A spin 0 boson is something new (2012), and surprises may *again* lie ahead!

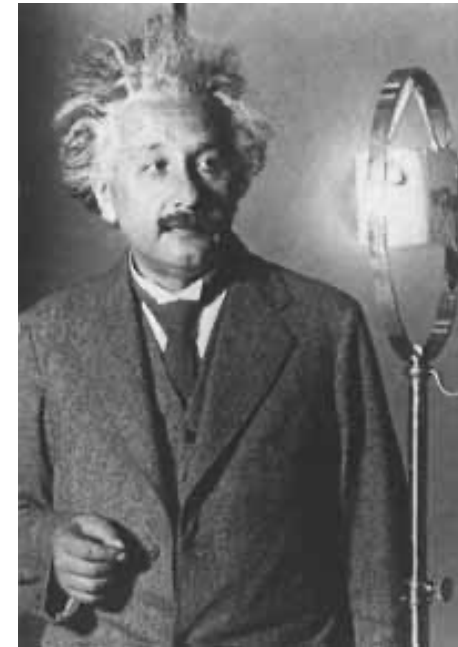

Picture credits: phy.cam.ac.uk/history/electron, spaceandmotion.com, CERN

We have proposed a dark matter candidate with very favorable features, including consistency with the results of current direct detection experiments, indirect detection experiments, collider detection experiments, and the observed abundance of dark matter.

(1) There is already strong – but not yet definitive -- evidence of indirect detection by Fermi-LAT and AMS-02.

(2) Collider detection may barely be possible with the high-luminosity LHC (but definitive studies may require a powerful $e^+ e^-$ linear collider or a 100 TeV hadron collider).

(3) Direct detection should soon be possible with XENONnT, LZ, and PandaX (but definitive studies may require even greater sensitivity).

The dark matter WIMP proposed here has the following properties:

- (1) It will yield the observed dark matter abundance if its mass is about $70 \text{ GeV}/c^2$.**
- (2) The cross-section for nuclear scattering is consistent with direct-detection limits.**
- (3) The cross-section for collider production is consistent with limits from the LHC.**
- (4) The cross-section for annihilation is consistent with the limits from gamma-ray observations of dwarf spheroidal galaxies.**
- (5) The mass and annihilation cross-section are in agreement with analyses of the observations of gamma rays from the Galactic center by Fermi-LAT supporting WIMP annihilation.**
- (6) They are similarly in agreement with analyses of the antiprotons observed by AMS-02 supporting this same interpretation.**
- (7) The most promising signature for collider detection appears to be two jets plus missing transverse energy of $\gtrsim 140 \text{ GeV}$ following creation through vector boson fusion, with a small but attainable cross-section.**
- (8) The best hope for direct detection appears to be a one-loop process with exchange of two vector bosons, again with a small but attainable cross-section.**
- (9) The present dark matter particle and the lightest neutralino of supersymmetry can stably coexist in a multicomponent dark matter scenario.**

Thanks for your attention!