

Pion Production Optimization for the Mu2e Experiment at Fermilab

APS DPF 2021

Helenka Casler

On behalf of the Mu2e Collaboration

July 13, 2021

What is Mu2e

New experiment under construction at Fermilab.

We are looking for new physics – **charged lepton flavor violation** (CLFV).

Rare interaction: muon converting to electron, without neutrinos, in the presence of an atomic nucleus.

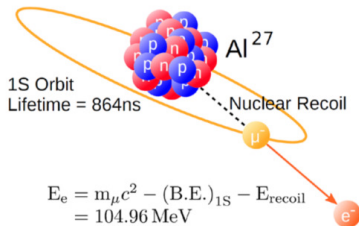

Standard Model rates for this interaction are below 10^{-50} – far too small to observe.

Any signal of CLFV is unambiguous evidence for physics beyond the Standard Model!

Experimental Overview

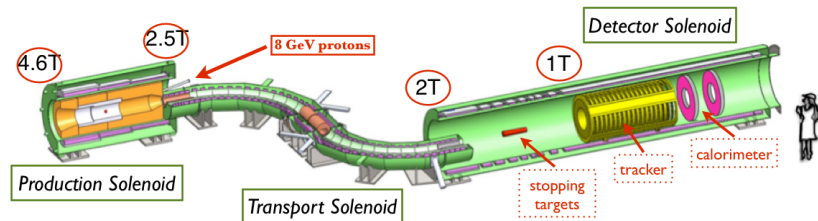

The Mu2e apparatus separates the production of muons and our observations of their decays.

Experimental Overview

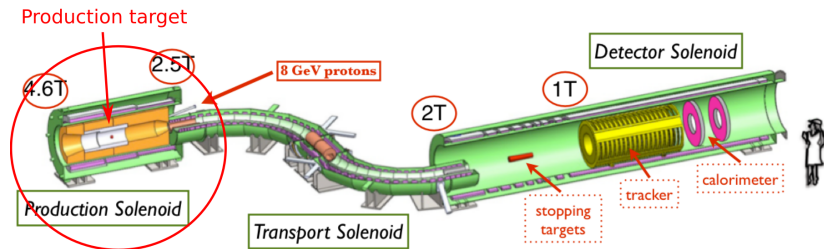

The proton beam strikes the production target, inside the production solenoid, producing pions. These pions then decay to muons.

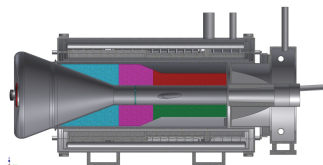

Experimental Overview

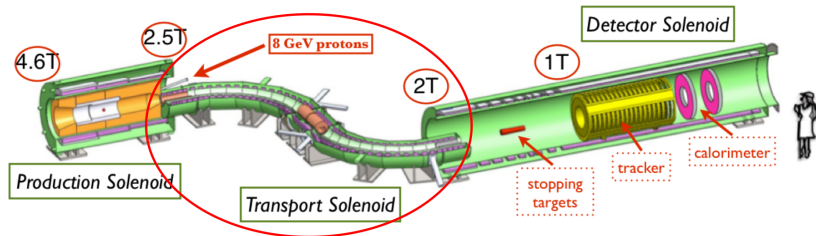

Slow (momentum < 80 MeV) muons are guided by the magnetic field through the Transport Solenoid. Uncharged particles, and fast particles, will not make it around the bend. The collimator in the center selects negatively-charged particles.

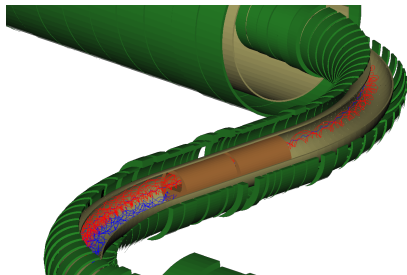

Experimental Overview

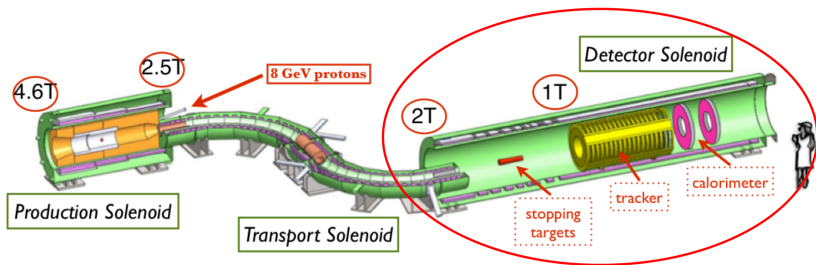

The muons enter the detector solenoid (DS), which contains the stopping target, tracker, and calorimeter. The stopping target stops the muons and is the site of $\mu \rightarrow e$ conversion. The tracker and calorimeter detect and identify the conversion electrons.

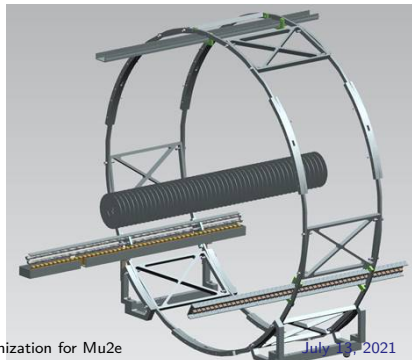

Experimental Overview

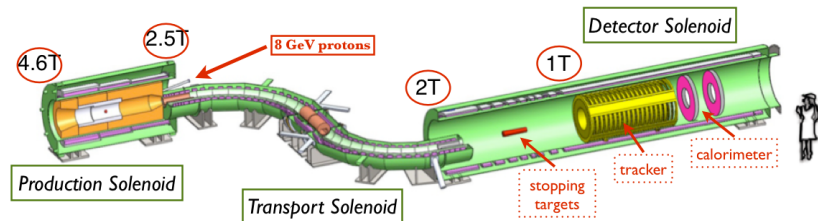

For more detail about the Mu2e experiment as a whole, check out Kate Ciampa's talk tomorrow

Sensitivity Goal

90% CL limit at 8×10^{-17} , which is a four order of magnitude improvement over previous experiments

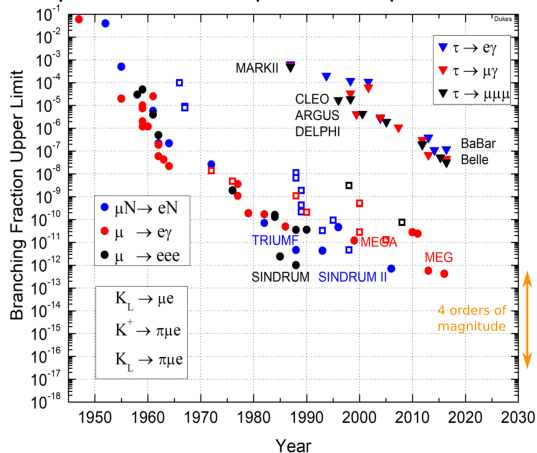

This will require 10^{10} muons to stop in the stopping target every second.

Sensitivity Goal

In order to maximize our muon stops, we need to:

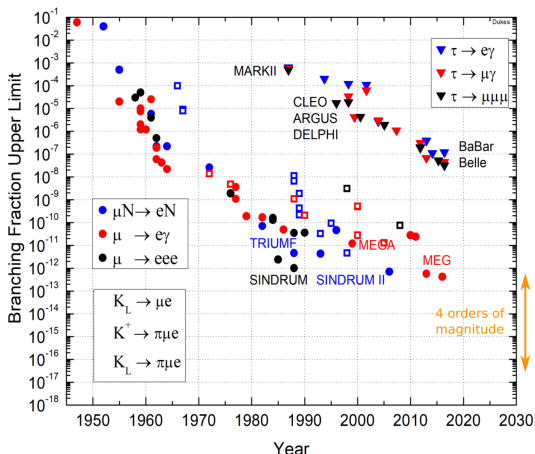

- ▶ produce as many pions as possible
- ▶ allow those pions to decay to muons
- ▶ effectively collect those muons at the stopping target

An optimal pion production system will be required to do all three.

Production Solenoid

Purpose: collect and focus pions and muons toward the transport solenoid

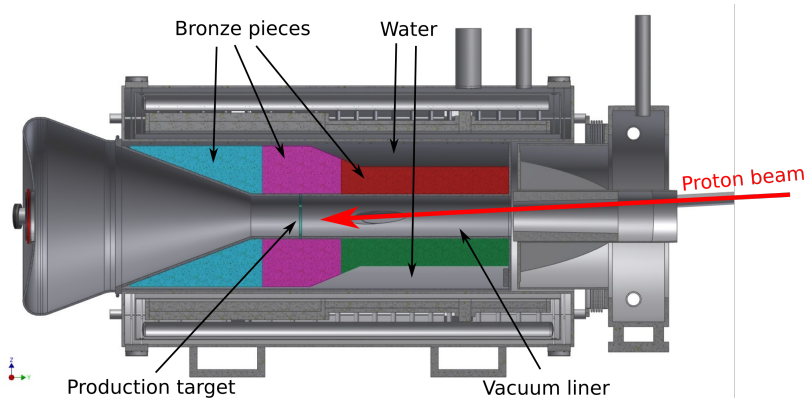

- ▶ Cryostat length: 4.5 m
- ▶ Superconducting solenoid – 3 NbTi coil modules
- ▶ Coils protected from heat and radiation from target by bronze shield
- ▶ Inner vacuum $\sim 10^{-5}$ torr

Production Solenoid

Solenoid produces a graded magnetic field: 2.5 T at the upstream end of the PS and 4.5 T at the downstream end.

Field gradient ~ 1 T/m

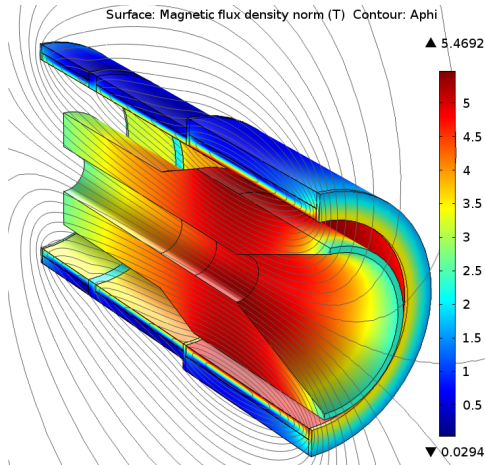

Gradient acts as a magnetic mirror, guiding slow, forward-moving negative pions and muons backwards toward the TS.

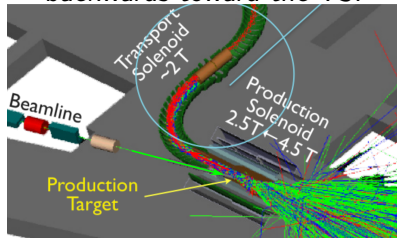

Production Target

Optimizing the production target was a major technical challenge. Target needs to:

1. Maximize pion production from the 8 GeV proton beam
2. Minimize reabsorption of pions
3. Survive one year of running before being replaced – replacement takes about 4 weeks

Items 1-2:

- ▶ low mass
- ▶ small geometric cross section
- ▶ high-density, high-Z material
- ▶ ideally no cooling system

Item 3:

- ▶ high melting point
- ▶ high thermal conductivity
- ▶ high emissivity

Best material choice: tungsten

To see how Mu2e II is solving this, check out Vitaly Pronskikh's talk, right after this one

Production Target Design – Issues to avoid

An early target design was projected to reach over 1730° C after a few minutes of beam running.
Beam power: 7.3 kW, depositing ~700 W in the target

Target heating via the proton beam can lead to several issues:

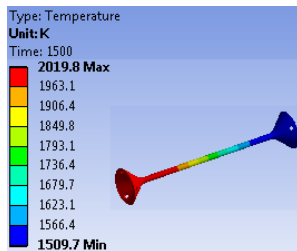

- ▶ **Oxidation:** residual O₂ and H₂O in vacuum → oxidation. At 1730° C, W oxides are volatile → erosion → reduced target lifetime
- ▶ **Creep:** at high enough temperatures, tungsten softens enough for mechanical stresses to deform the target by up to 1 mm after only 30 days
- ▶ **Thermal stress:** target does not heat uniformly → parts that heat more expand more, but are constrained by parts that heat up less
- ▶ **Recrystallization:** at 1300 C (1500 for La₂O₃-doped W) deformed grains in the material are replaced by defect-free grains, resulting in loss of hardness and strength

Production Target – Final Design

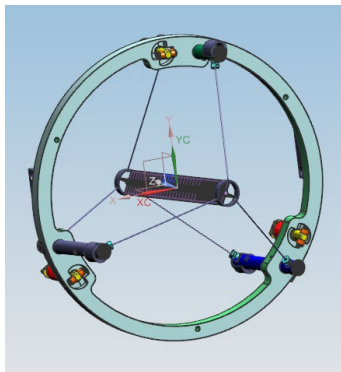
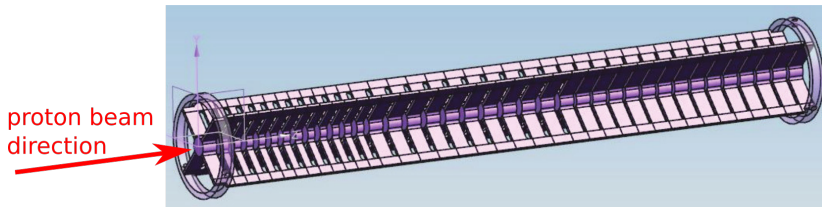

Material: tungsten

Total length: 220 mm

Core radius: 3.15 mm

Fins: height 13 mm, for heat dissipation

Core and fins are sectioned, with smaller sections and larger gaps at the upstream end of the target

Support rings on the end attach to tungsten spokes, which attach to the outer support structure

Production Target – Final Design

This keeps the peak temperature below 1200° C. Max temp is reached within 25 mins of beam exposure.

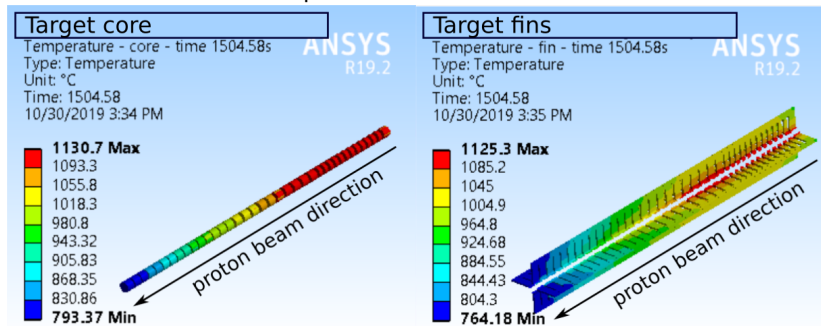

At this temp, creep, oxidation, and recrystallization are not a problem. Gaps in the target core allow for some thermal expansion in the hottest parts, reducing thermal stress. Expect ~ 0.0015 stopped muons per proton on target, which meets our production requirements.

Successful balance of target stability and pion production

Production Target – Final Design

This keeps the peak temperature below 1200° C. Max temp is reached within 25 mins of beam exposure.

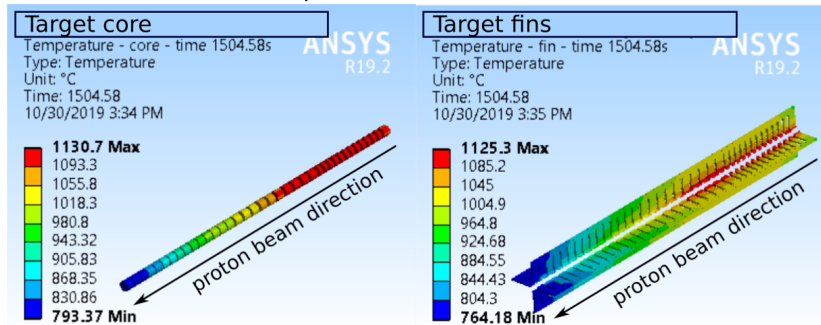

...As long as the beam hits the target in the center...

Production Target Monitor

Requirement: beam to hit the target core within ± 0.5 mm of the center

Instrumentation: pair of proportional wire chambers (PWC's) between PS exit and proton beam dump, 3.5 m and 4.5 m downstream from PS exit

Relative Stopped Muons vs Beam Offset

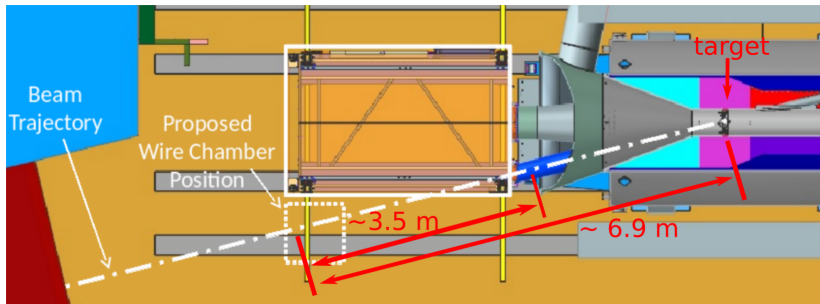
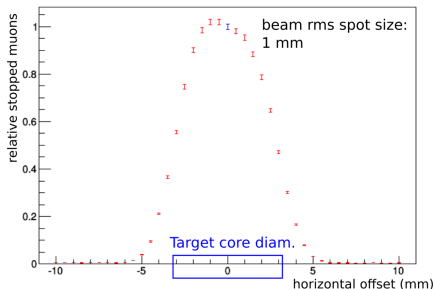

Production Target Monitor

Simulation
image of
PWC
positioning

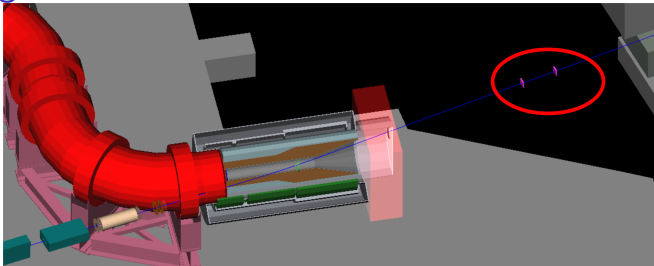

PWC's built
and set up to
be tested in
beam

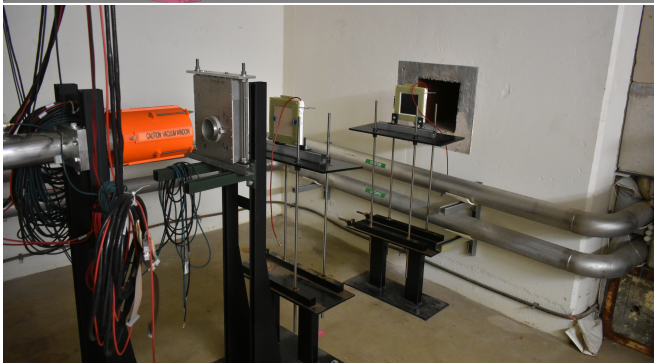

Production Target Monitor

Use PTM during start-up to find optimal beam positioning on the target

- ▶ Beam can be moved slightly while running: up to ± 10 mm vertically and horizontally, up to $\pm 0.15^\circ$ vertically and horizontally
- ▶ Scan beam across different positions, using the profile on the downstream PWC's to find the edges and center of the target

Simulation: proton distribution at detector changes dramatically as beam passes edge of target core, allowing us to find the edge of the target with far greater precision than the 2 mm wire separation of the PWC's.

% Beam Protons Passing Through Downstream Detector

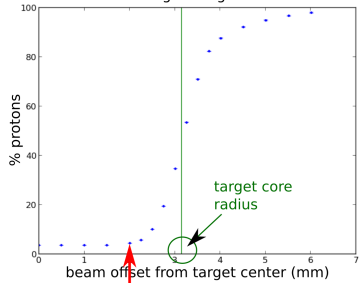

Beam 2.01 mm off center

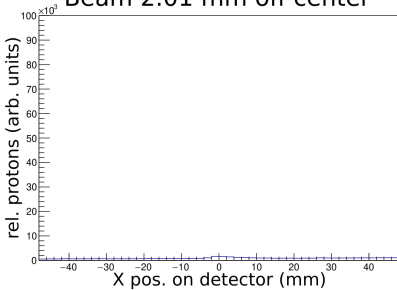

Production Target Monitor

Use PTM during start-up to find optimal beam positioning on the target

- ▶ Beam can be moved slightly while running: up to ± 10 mm vertically and horizontally, up to $\pm 0.15^\circ$ vertically and horizontally
- ▶ Scan beam across different positions, using the profile on the downstream PWC's to find the edges and center of the target

Simulation: proton distribution at detector changes dramatically as beam passes edge of target core, allowing us to find the edge of the target with far greater precision than the 2 mm wire separation of the PWC's.

% Beam Protons Passing Through Downstream Detector

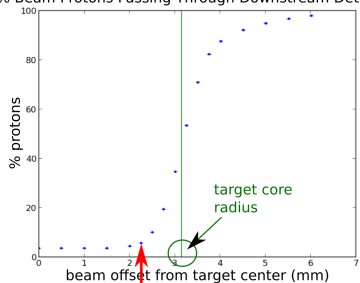

Beam 2.26 mm off center

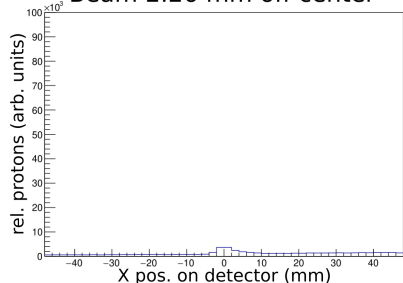

Production Target Monitor

Use PTM during start-up to find optimal beam positioning on the target

- ▶ Beam can be moved slightly while running: up to ± 10 mm vertically and horizontally, up to $\pm 0.15^\circ$ vertically and horizontally
- ▶ Scan beam across different positions, using the profile on the downstream PWC's to find the edges and center of the target

Simulation: proton distribution at detector changes dramatically as beam passes edge of target core, allowing us to find the edge of the target with far greater precision than the 2 mm wire separation of the PWC's.

% Beam Protons Passing Through Downstream Detector

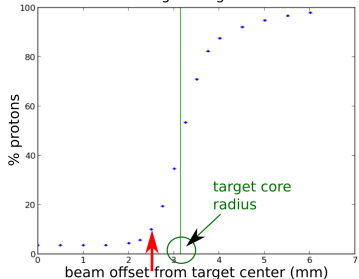

Beam 2.51 mm off center

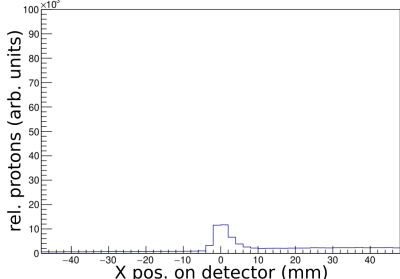

Production Target Monitor

Use PTM during start-up to find optimal beam positioning on the target

- ▶ Beam can be moved slightly while running: up to ± 10 mm vertically and horizontally, up to $\pm 0.15^\circ$ vertically and horizontally
- ▶ Scan beam across different positions, using the profile on the downstream PWC's to find the edges and center of the target

Simulation: proton distribution at detector changes dramatically as beam passes edge of target core, allowing us to find the edge of the target with far greater precision than the 2 mm wire separation of the PWC's.

% Beam Protons Passing Through Downstream Detector

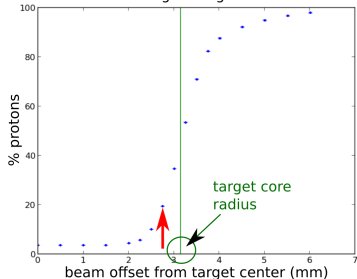

Beam 2.76 mm off center

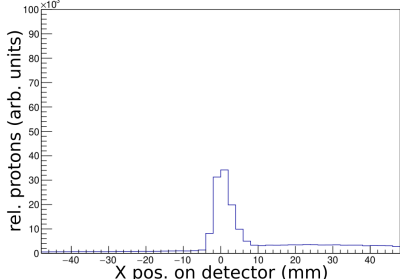

Production Target Monitor

Use PTM during start-up to find optimal beam positioning on the target

- ▶ Beam can be moved slightly while running: up to ± 10 mm vertically and horizontally, up to $\pm 0.15^\circ$ vertically and horizontally
- ▶ Scan beam across different positions, using the profile on the downstream PWC's to find the edges and center of the target

Simulation: proton distribution at detector changes dramatically as beam passes edge of target core, allowing us to find the edge of the target with far greater precision than the 2 mm wire separation of the PWC's.

% Beam Protons Passing Through Downstream Detector

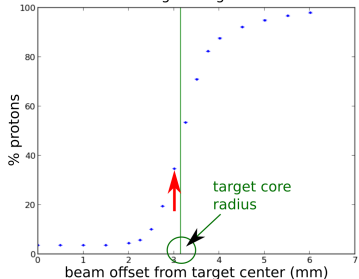

Beam 3.01 mm off center

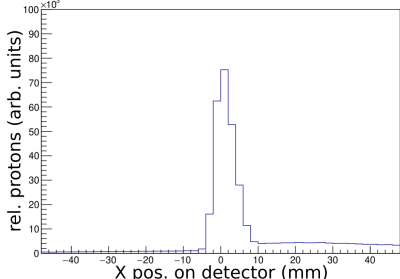

Production Target Monitor

Use PTM during start-up to find optimal beam positioning on the target

- ▶ Beam can be moved slightly while running: up to ± 10 mm vertically and horizontally, up to $\pm 0.15^\circ$ vertically and horizontally
- ▶ Scan beam across different positions, using the profile on the downstream PWC's to find the edges and center of the target

Simulation: proton distribution at detector changes dramatically as beam passes edge of target core, allowing us to find the edge of the target with far greater precision than the 2 mm wire separation of the PWC's.

% Beam Protons Passing Through Downstream Detector

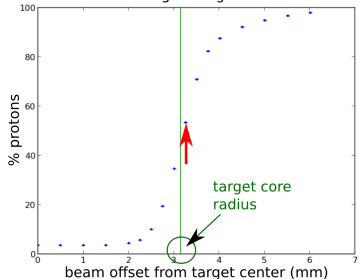

Beam 3.26 mm off center

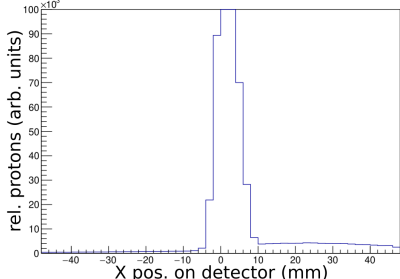

Production Target Monitor

Use PTM during start-up to find optimal beam positioning on the target

- ▶ Beam can be moved slightly while running: up to ± 10 mm vertically and horizontally, up to $\pm 0.15^\circ$ vertically and horizontally
- ▶ Scan beam across different positions, using the profile on the downstream PWC's to find the edges and center of the target

Simulation: proton distribution at detector changes dramatically as beam passes edge of target core, allowing us to find the edge of the target with far greater precision than the 2 mm wire separation of the PWC's.

% Beam Protons Passing Through Downstream Detector

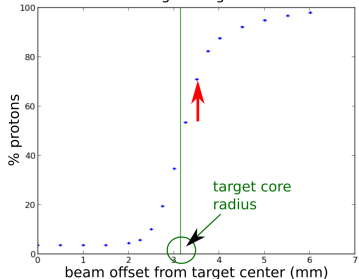

Beam 3.51 mm off center

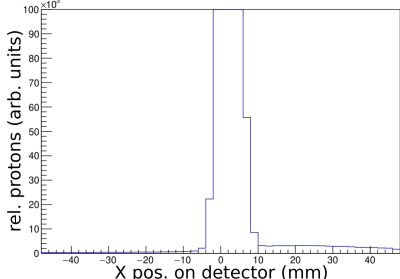

Summary

- ▶ Mu2e will search for charged lepton flavor violation in the neutrinoless conversion of muons to electrons
- ▶ To do this, we must optimize our pion production to maximize muons stopped in the stopping target while minimizing backgrounds
- ▶ The Production Solenoid will use a graded magnetic field to guide pions and muons into the Transport Solenoid, backwards relative to the proton beam direction
- ▶ The Production Target will successfully balance the need to produce the maximum number of pions with the need for the target to survive one year in the beam
- ▶ The Production Target Monitor will allow the proton beam to be aimed correctly at the production target, maximizing both pion production and target longevity

Other Mu2e Talks at DPF

Tuesday

Vitaly Pronskikh: Pion Production Target Design Studies for Mu2e-II, 4:30pm

Craig Group: Fabrication of a High Efficiency Cosmic Ray Veto for Mu2e, 4:15pm

Sydney Roberts: Performance of Enhanced Wavelength-shifting Fibers for the Mu2e CRV, 4:30pm

Craig Dukes: A Novel Scintillator for the Mu2e-II Experiment, 4:45pm

Yongyi Wu: Mu2e Straw Tube Tracker Panel Performance Studies, 5:00pm

Haichuan Cao: Design for Mu2e Branching Ratio Normalization Detectors, 5:15pm

Wednesday

Kate Ciampa: The Mu2e Experiment Overview, 2:30pm

Yuri Oksuzian: Simulation of the Cosmic Ray Background for Mu2e, 2:45pm

Mackenzie Devilbiss: Cosmic Ray Event Reconstruction in Mu2e, 3:00pm

Xiaobing Shi: Calibration of Mu2e Absolute Momentum Scale Using $\pi^+ \rightarrow e^+ \nu$, 3:15pm

Digvijay Roy Varier: Machine Learning for Background Hit Rejection in the Mu2e Tracker, 3:30pm

Shihua Huang: A FAMILON Search Using the Mu2e Calibration Run, 3:45pm

Jijun Chen: Normalization of the Mu2e Experiment, 4:15pm

Nam Tran: Photons after Muon Capture on Aluminum and Titanium, 4:30pm

Backups

Proton Beam Timing

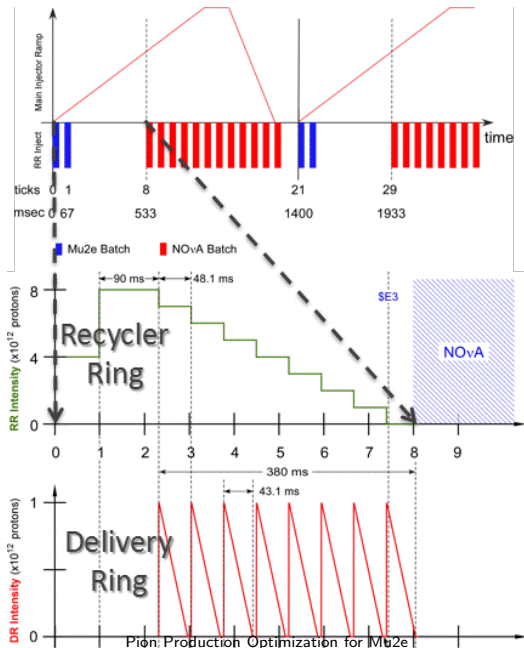

Proton Beam and Signal Timing

Protons in the Delivery Ring are slow-spilled to Mu2e via resonant extraction, resulting in a pulsed beam. Each pulse contains $\sim 10^7$ protons.

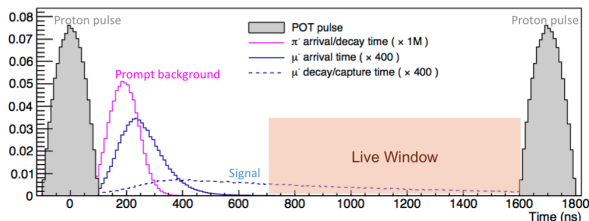

Pulse separation and duration driven by separating signal from prompt background in time. Require:

- ▶ pulse duration \ll muonic AI lifetime
- ▶ pulse separation $>$ muonic AI lifetime

Orbital period of the Delivery Ring is 1695 ns – $\sim 2\times$ muonic AI lifetime.

Production Target Early Design

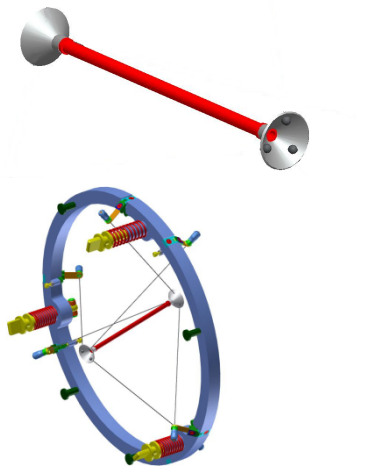

- ▶ Tungsten
- ▶ Radius 3.15 mm
- ▶ Length 160 mm (tungsten nuclear interaction length: 9.9 cm)
- ▶ Cone-shaped hubs at the ends for support
- ▶ "Bicycle wheel" support structure with thin tungsten support rods
- ▶ Radiatively cooled

Max temp > 2000 K, reached within few minutes of beam exposure.

Power Density in Production Target

Early target design

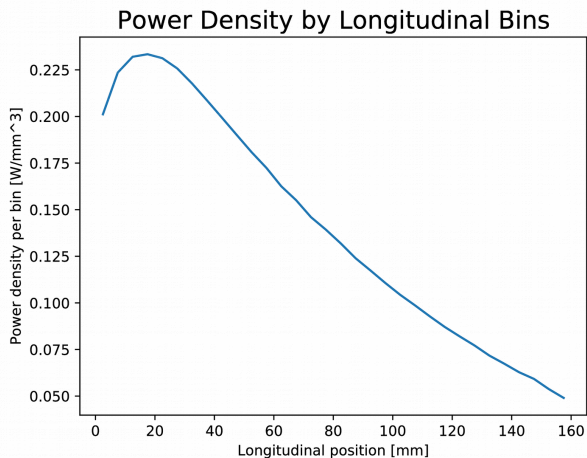

Proportional Wire Chambers

Rows of signal wires sandwiched between high-voltage bias planes, surrounded by gas. Incident particles ionize the gas, and the ionization electrons drift to the wires. At high bias voltages, the electrons are accelerated enough to cause a Townsend avalanche.

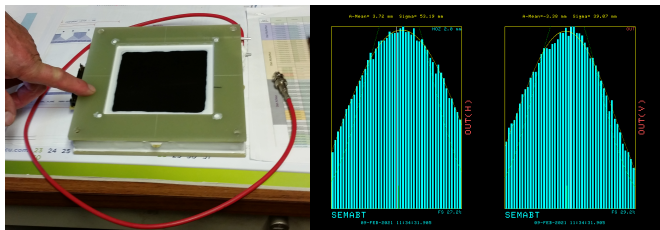

PWC's used for PTM are a model in common use at FNAL:

- ▶ Active cross section: 96 mm \times 96 mm
- ▶ wire separation: 2 mm
- ▶ wire material: gold-plated tungsten, diameter 10 μ m
- ▶ gas mixture: 80% Ar 20% CO₂
- ▶ bias voltage: \sim 1 kV