

HEAVY FLAVOR AND QUARKONIA PHYSICS AT SPHENIX

Thomas Marshall
University of California - Los Angeles
For the sPHENIX Collaboration

Overview

- sPHENIX Physics Program and Detectors
- Tracking Reconstruction Progress
- Heavy Flavor (HF) and Quarkonia Physics Motivation and Projections
- Recent Studies and Results
- Assembly and Installation Progress
- Summary

sPHENIX Physics Program

- Next generation of RHIC detectors
- Detailed study of:
 - Quark-Gluon Plasma produced at RHIC
 - Parton energy loss and structure
 - Mass dependent energy loss
- p+p, p+Au, Au+Au collisions

Jets and Photons

[Virginia's talk earlier in the week](#)

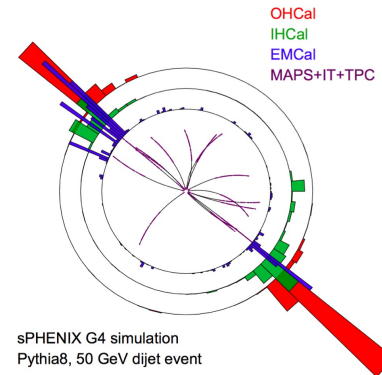

Upsilon

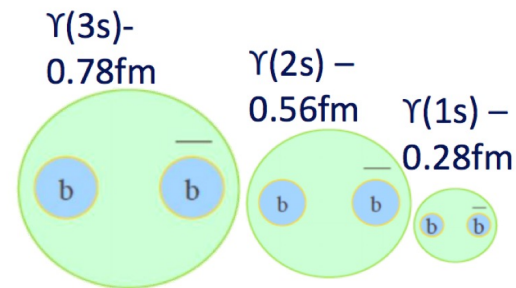

Open Heavy Flavor



Cold QCD

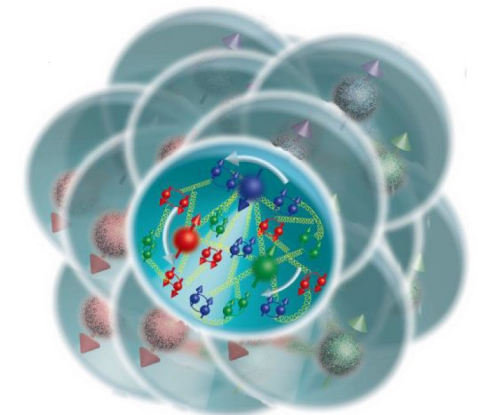

sPHENIX Detector

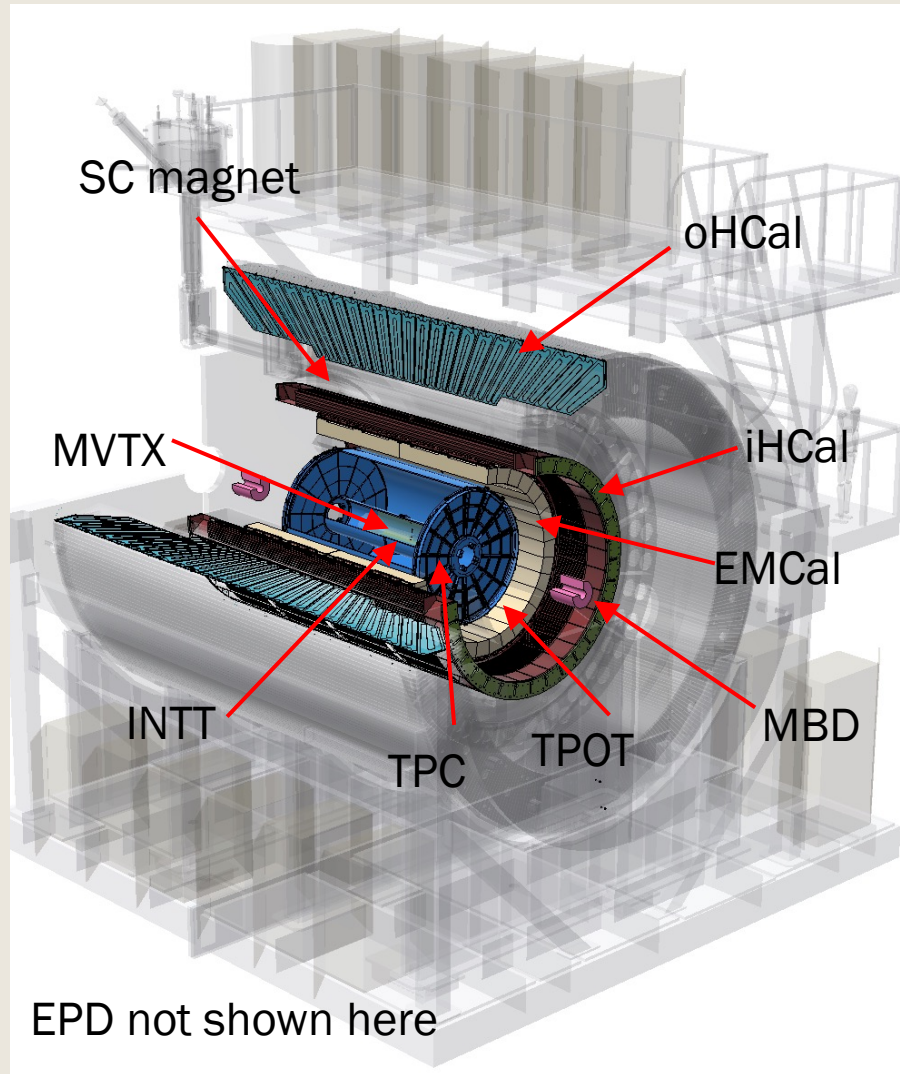

- 1.4 T solenoidal B field
- 15 kHz Trigger plus streaming readout events
- $|\eta| \leq 1.1$
- Full 2π azimuthal coverage
- *“sPHENIX construction, installation and operation to accomplish its science goals is now the overarching priority for RHIC for the next 4-5 years” - [PAC Report, June 2021](#)*

Year	Species	$\sqrt{s_{NN}}$ [GeV]	Cryo Weeks	Physics Weeks	Rec. Lum. $ z < 10$ cm	Samp. Lum. $ z < 10$ cm
2023	Au+Au	200	24 (28)	9 (13)	3.7 (5.7) nb ⁻¹	4.5 (6.9) nb ⁻¹
2024	$p^\uparrow p^\uparrow$	200	24 (28)	12 (16)	0.3 (0.4) pb ⁻¹ [5 kHz] 4.5 (6.2) pb ⁻¹ [10%-str]	45 (62) pb ⁻¹
2024	$p^\uparrow + Au$	200	–	5	0.003 pb ⁻¹ [5 kHz] 0.01 pb ⁻¹ [10%-str]	0.11 pb ⁻¹
2025	Au+Au	200	24 (28)	20.5 (24.5)	13 (15) nb ⁻¹	21 (25) nb ⁻¹

[sPHENIX Beam Use Proposal](#), 2021.

Tracking Detectors

- MAPS-based micro-VerTeX detector (MVTX):
 - $30\ \mu\text{m}$ pitch MAPS pixels
 - 3 layers, $2.3\ \text{cm} < r < 3.9\ \text{cm}$
 - $\sim 5\ \mu\text{m}$ space point precision each
 - 5-10 μs integration time

- INTermediate silicon strip Tracker (INTT):
 - 4 layers, $6 < r < 12\ \text{cm}$
 - Pitch $78\ \mu\text{m}$
 - Fast enough to resolve one beam crossing

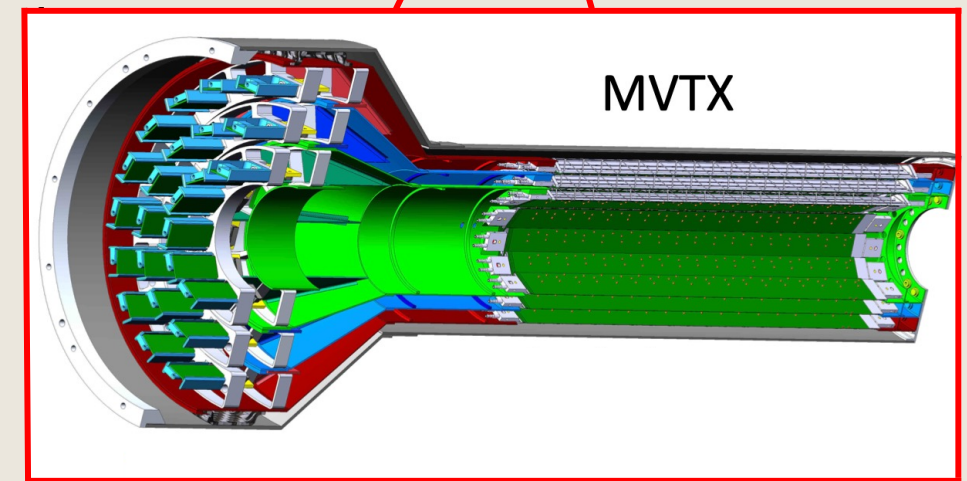
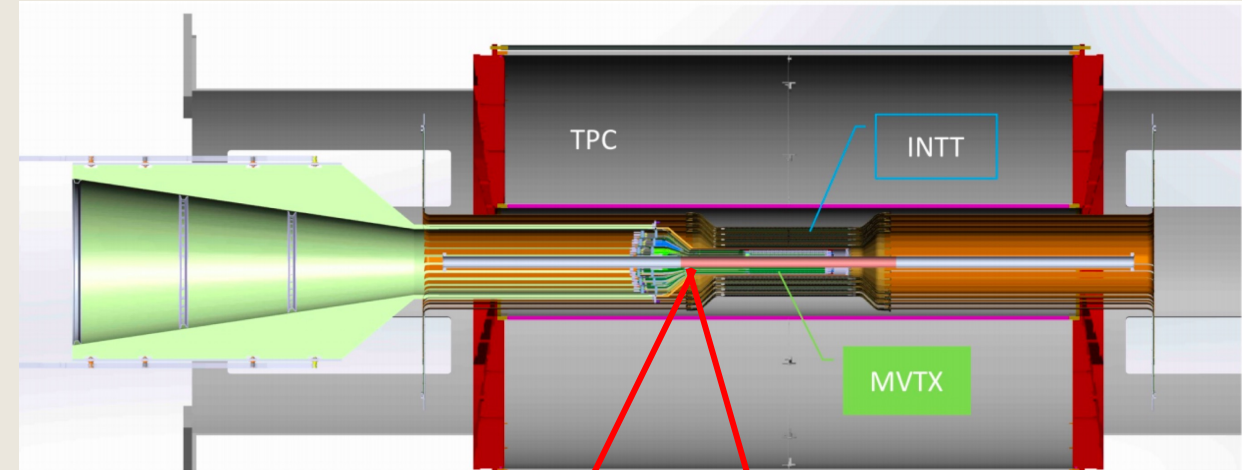

Dean, Cameron. [Heavy Flavor at sPHENIX](#). Jun. 9, 2021.

Frawley, Anthony. [Quarkonium Detection and Physics with sPHENIX](#). Oct. 25-27, 2021.

Tracking Detectors

- Time Projection Chamber (TPC):
 - 50:50 Ne-CF₄ gas
 - 8 cm/ μ s electron drift velocity
 - 48 layers, 30 < r < 78 cm
 - $\Delta p/p \sim 1\%$ at 5 GeV/c

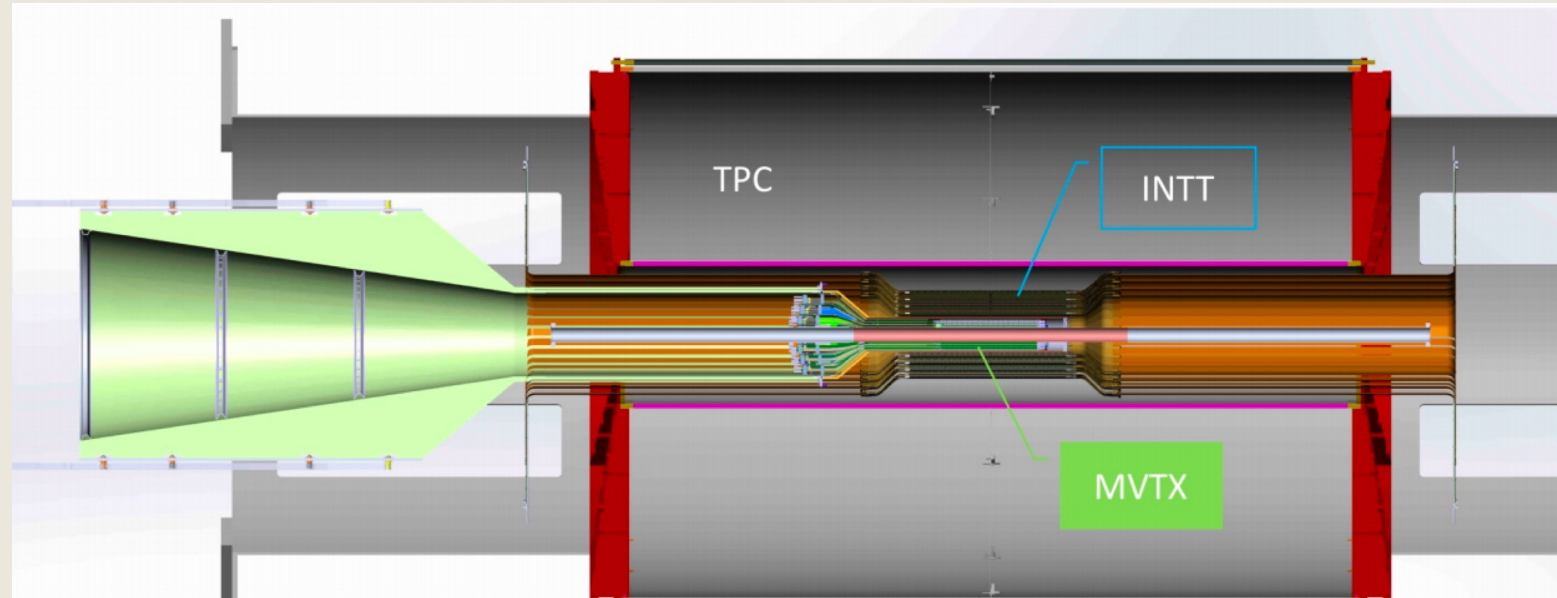

Dean, Cameron. [Heavy Flavor at sPHENIX](#). Jun. 9, 2021.
 Frawley, Anthony. [Quarkonium Detection and Physics with sPHENIX](#). Oct. 25-27, 2021.

Recent Progress in Tracking Performance

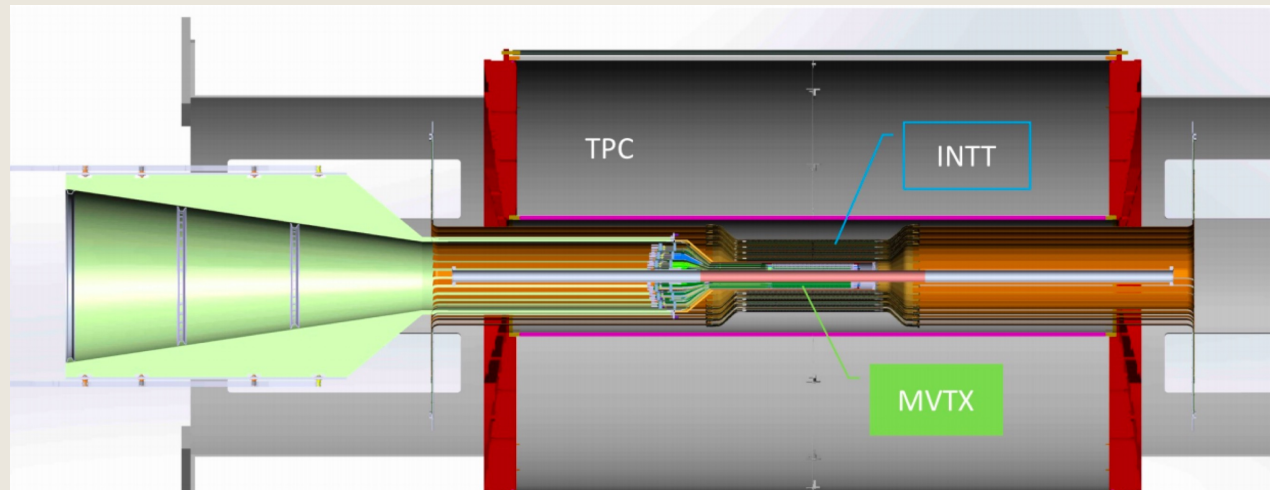

- Requiring MVTX hits for HF analysis drops the efficiency by ~5-10%

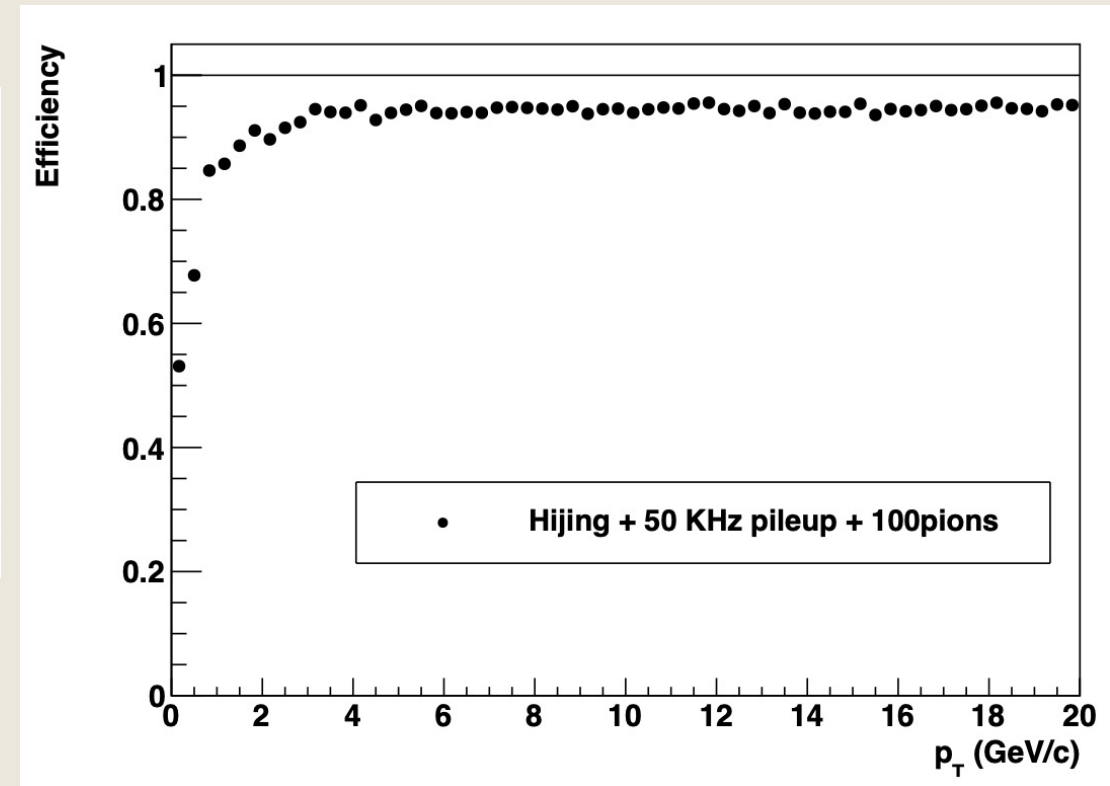

Frawley, Anthony. [Quarkonium Detection and Physics with sPHENIX](#). Oct. 25-27, 2021.

Recent Progress in Tracking Performance

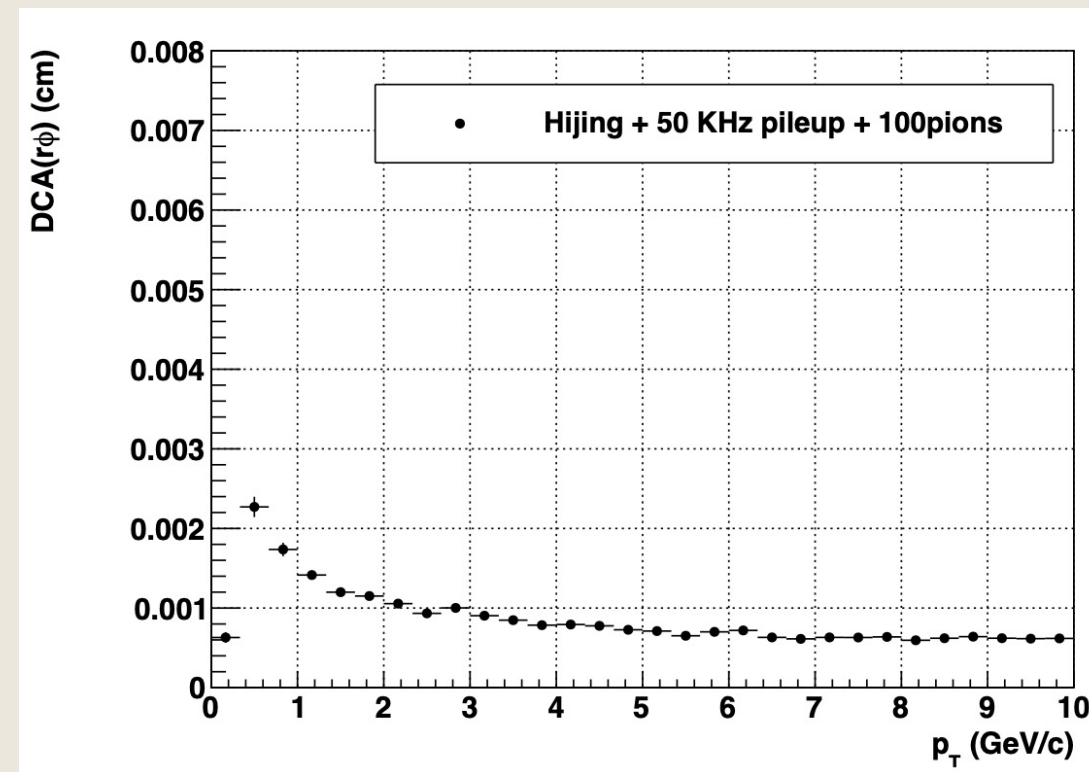
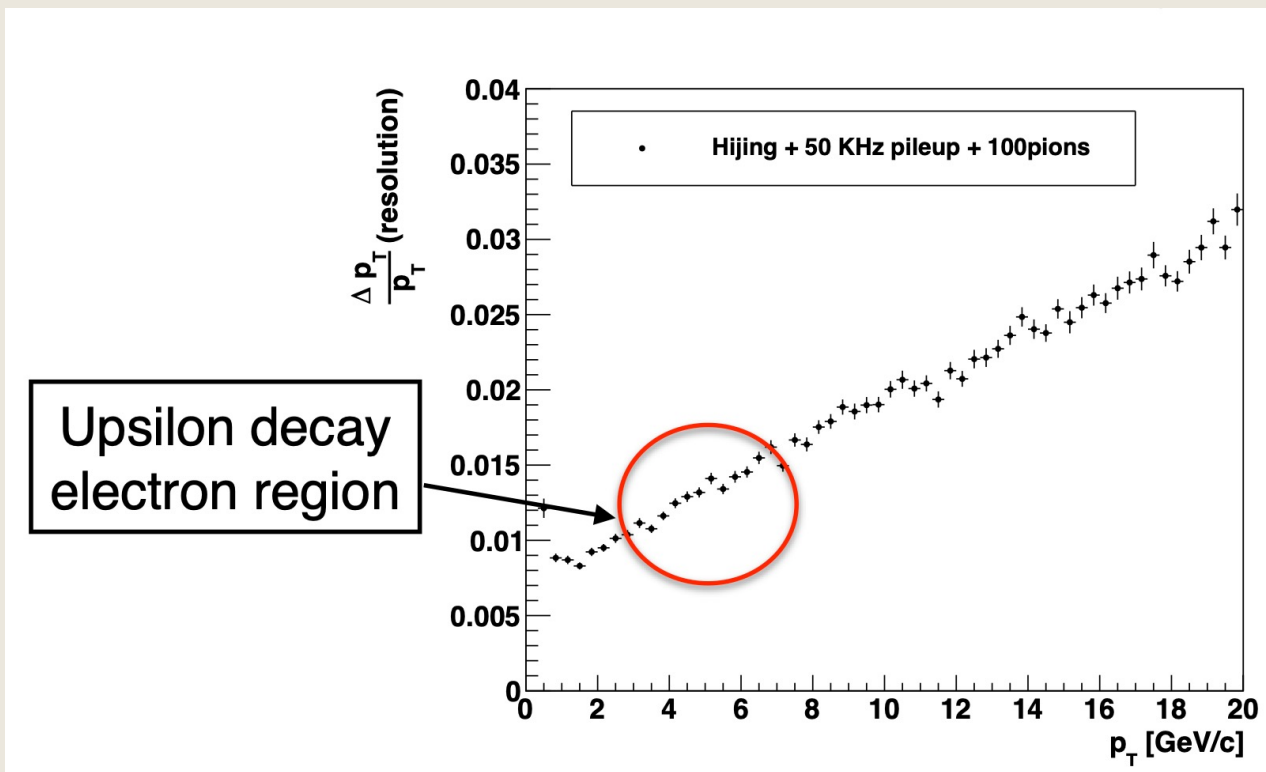

Implementation of TPC clustering designed to handle overlaps should further improve efficiency and p_T resolution

Frawley, Anthony. [Quarkonium Detection and Physics with sPHENIX](#). Oct. 25-27, 2021.

Upsilon Mass Reconstruction

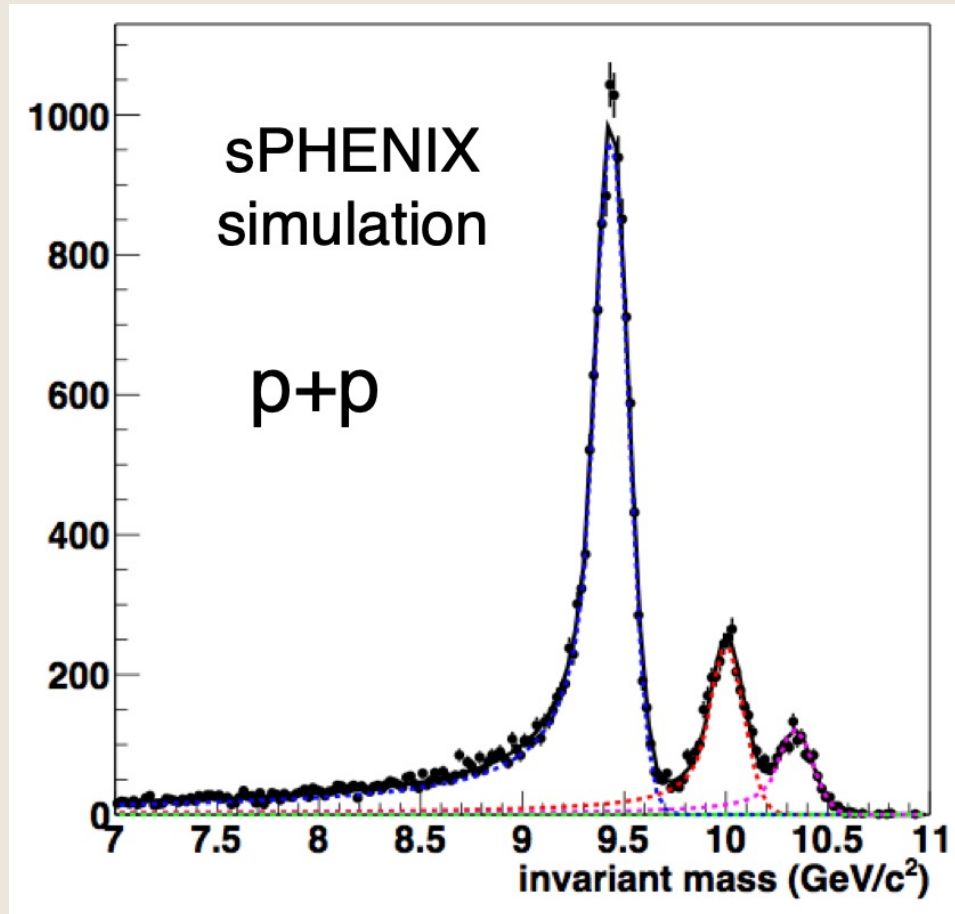

Frawley, Anthony. [Quarkonium Detection and Physics with sPHENIX](#). Oct. 25-27, 2021.

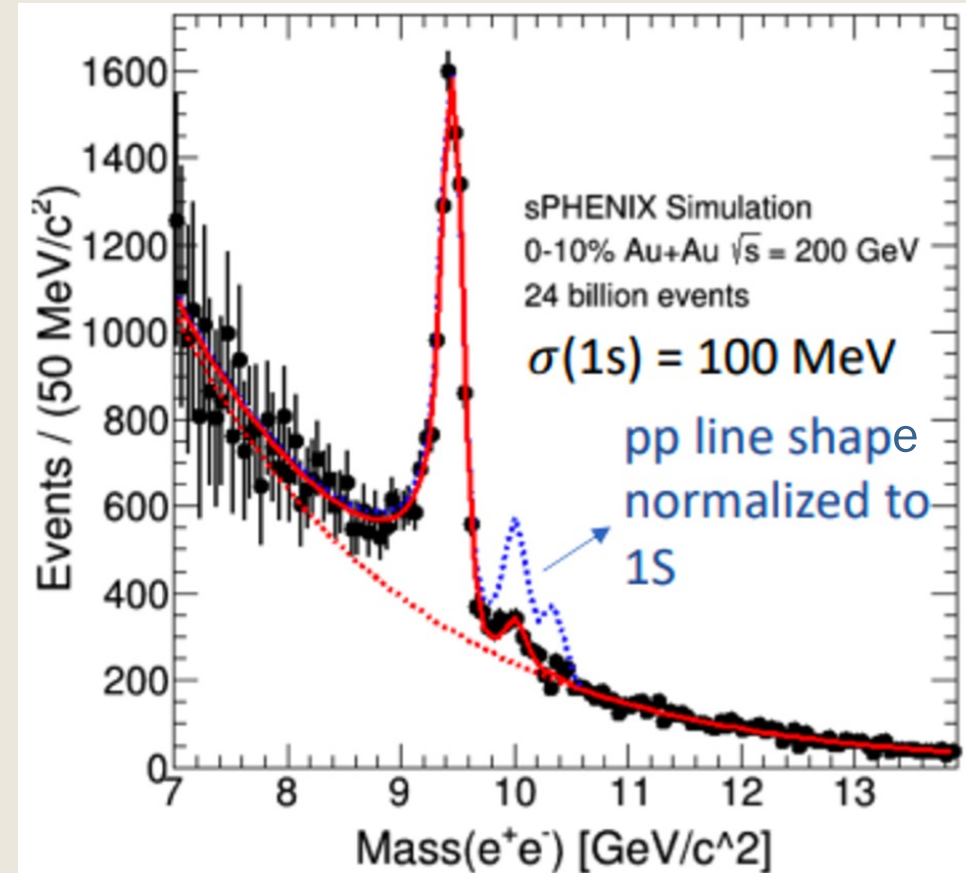

cf. [CMS PbPb measurement using \$\mu^+ \mu^-\$](#)

Quarkonia Physics at sPHENIX

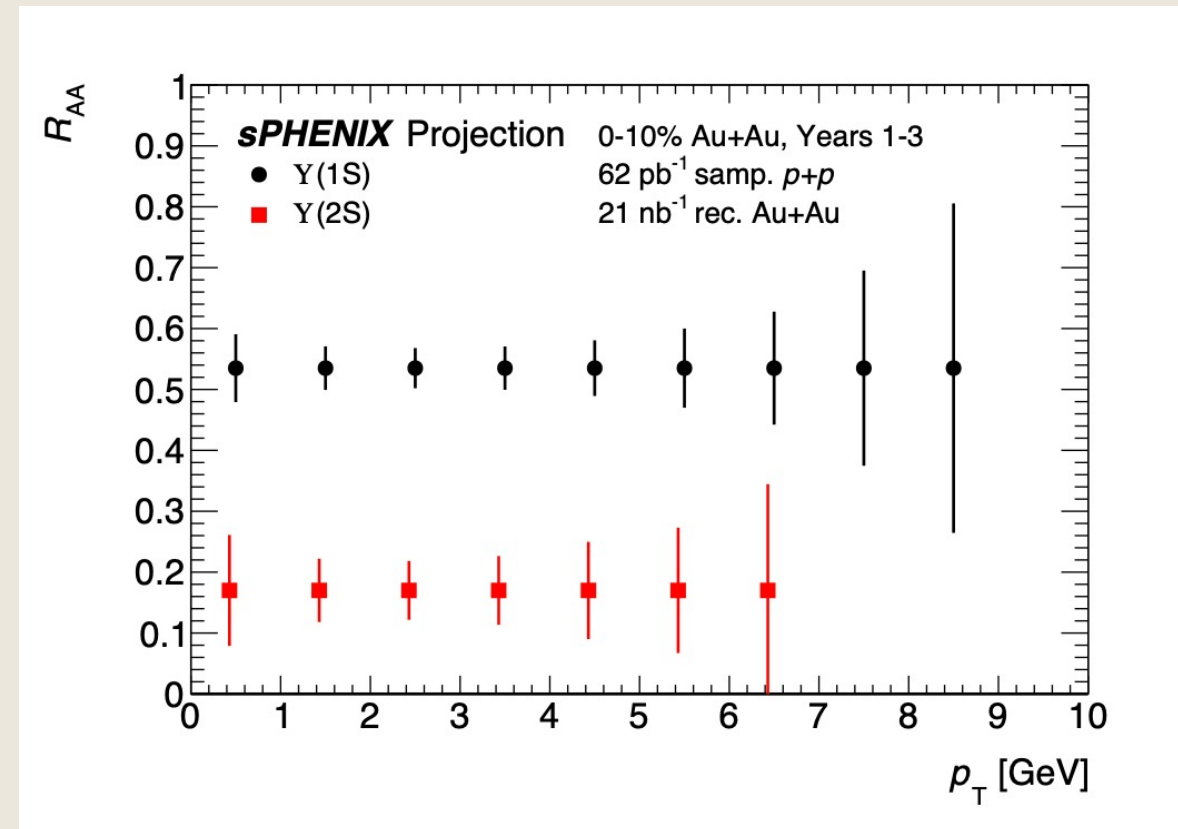
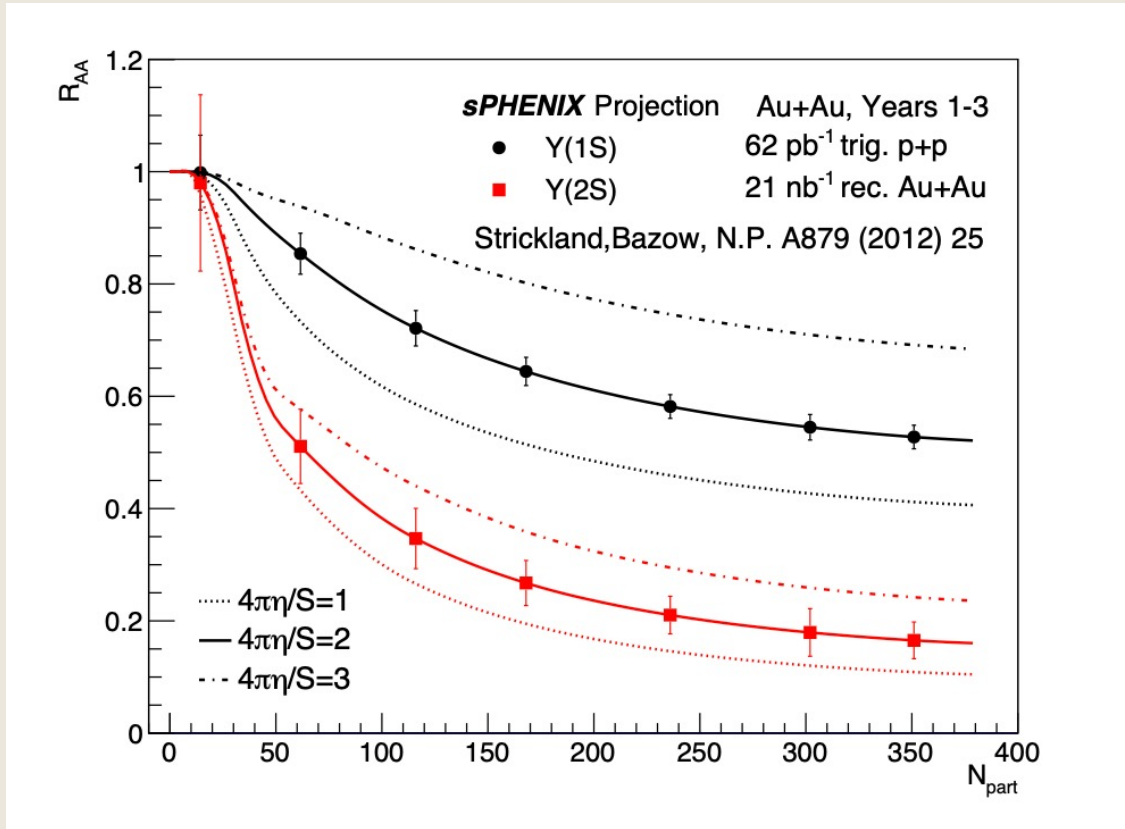

- Y(3s) state heavily suppressed
- Uses expected luminosity from 2024 p+p run and 2025 Au+Au run

Open Heavy Flavor Physics at sPHENIX

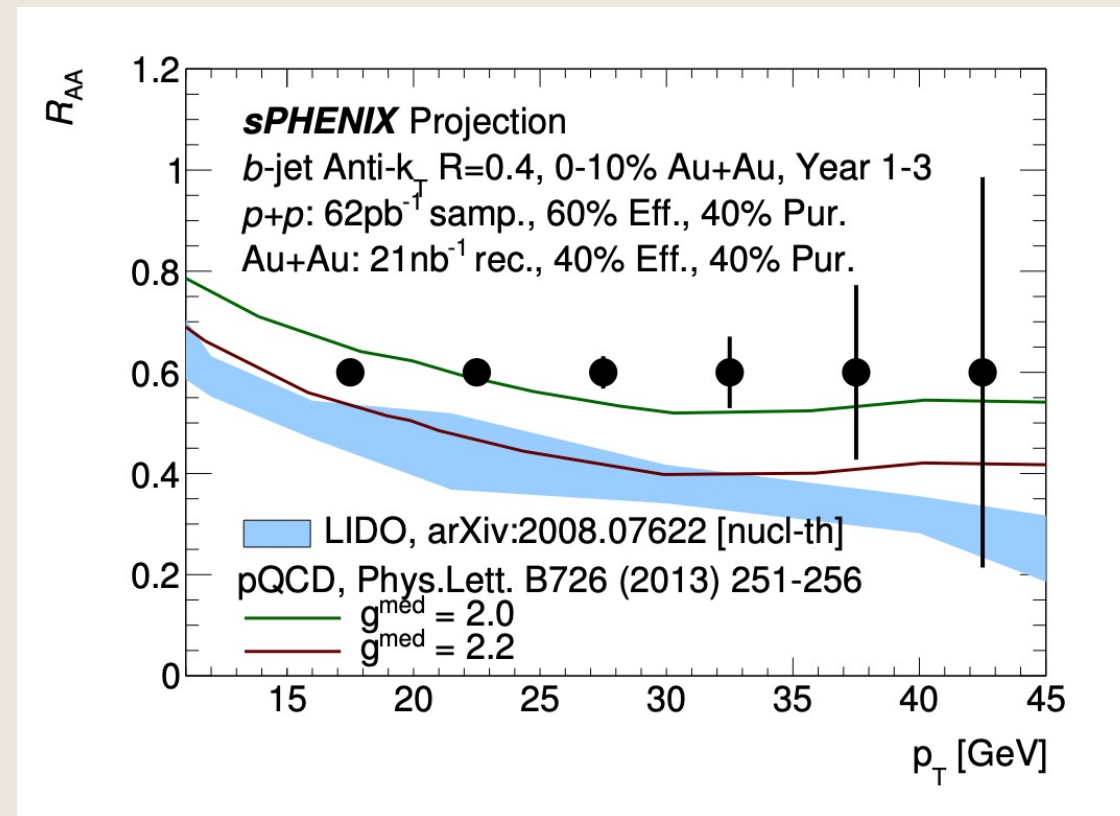
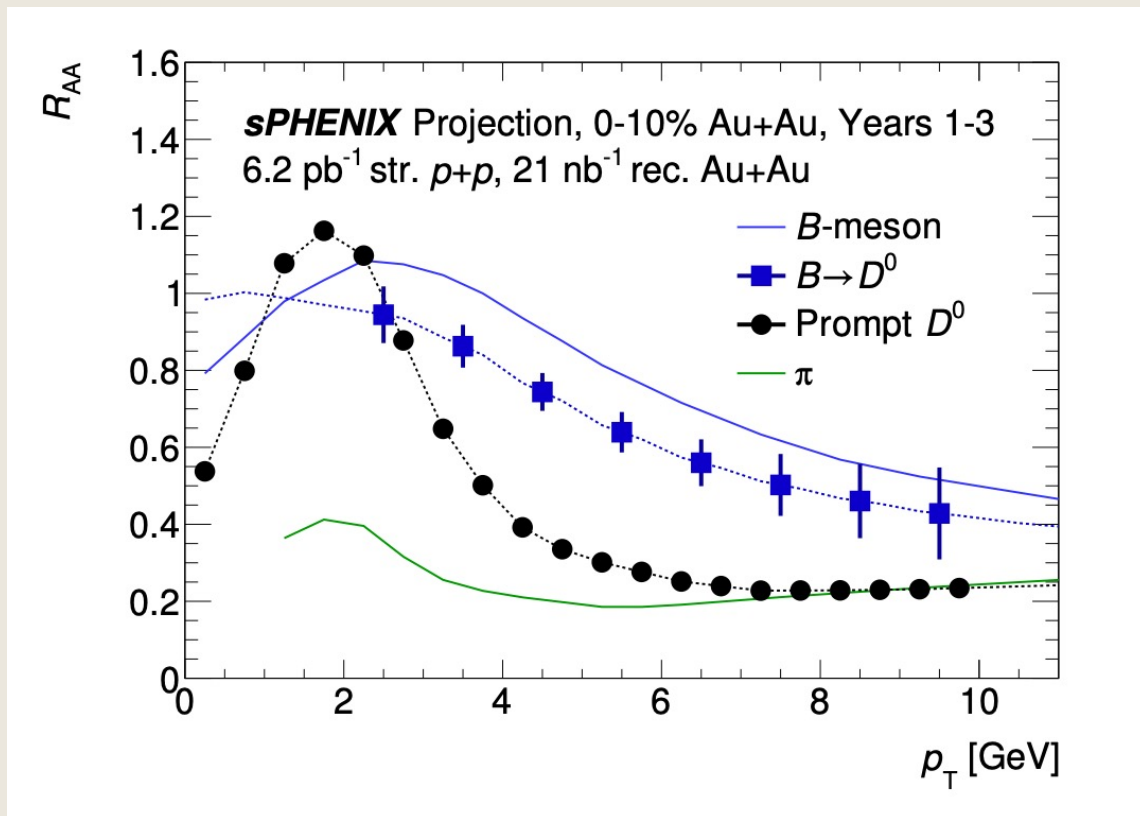

- R_{AA} for bottom quarks and light quarks expected to be different for $p_T \lesssim 15$ GeV
- Less significant for *b*-jets at higher p_T

[sPHENIX Beam Use Proposal](#), 2021.

Open Heavy Flavor Physics at sPHENIX

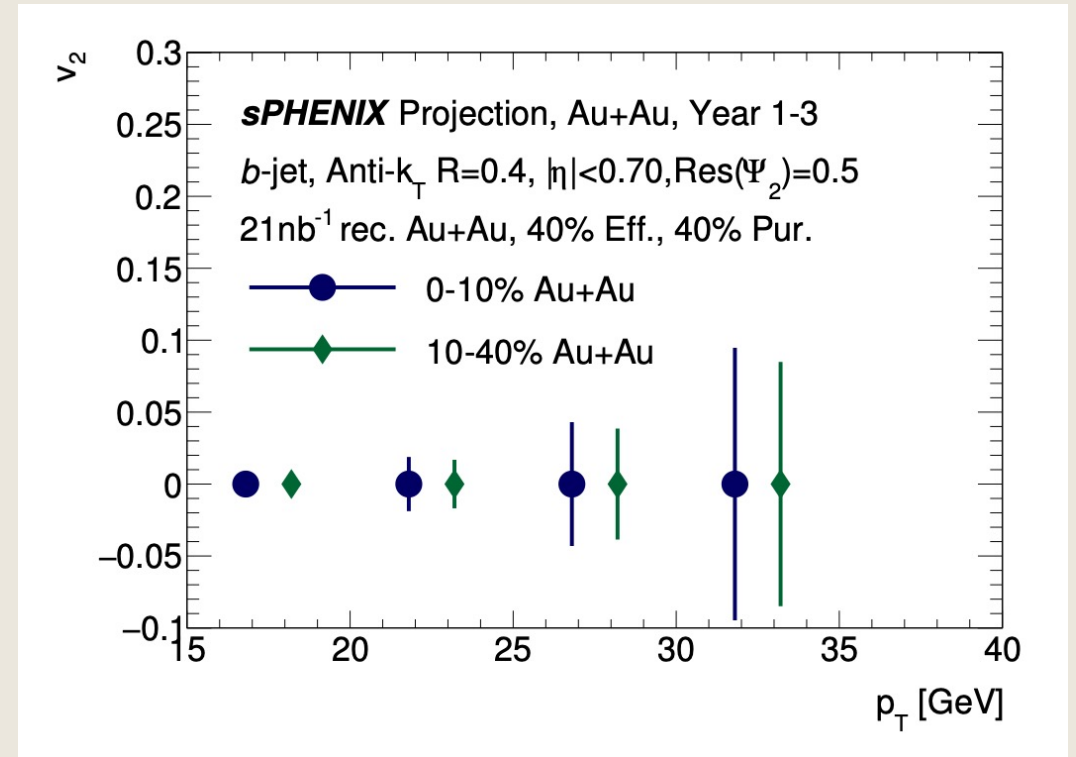
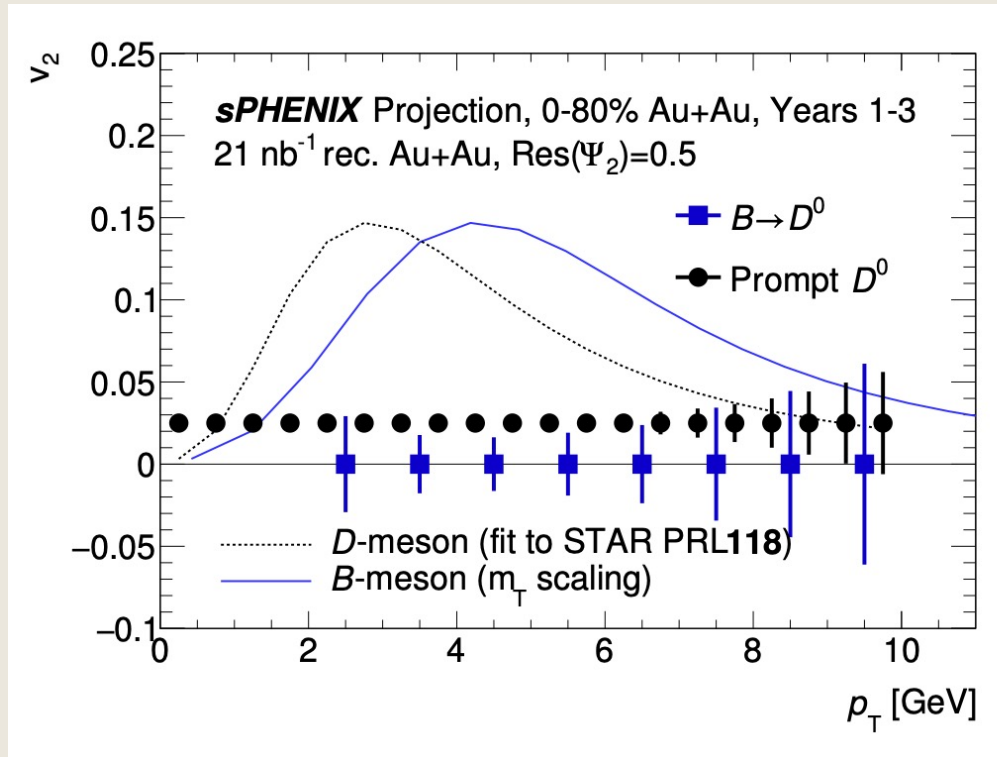

- Collective motion of particles sensitive to initial stages of collision (deconfined QGP phase)
- Precision bottom measurements allow better constraints on heavy quark diffusion transport parameter of QGP and its temperature dependence

Open Heavy Flavor Physics at sPHENIX

- RHIC and LHC data suggest significant enhancement of Λ_c baryon to D^0 meson production ratio in p+p, p+A, and A+A collisions
- sPHENIX enables first p+p Λ_c/D^0 measurement at RHIC
- Increased understanding of charm hadronization in the QGP

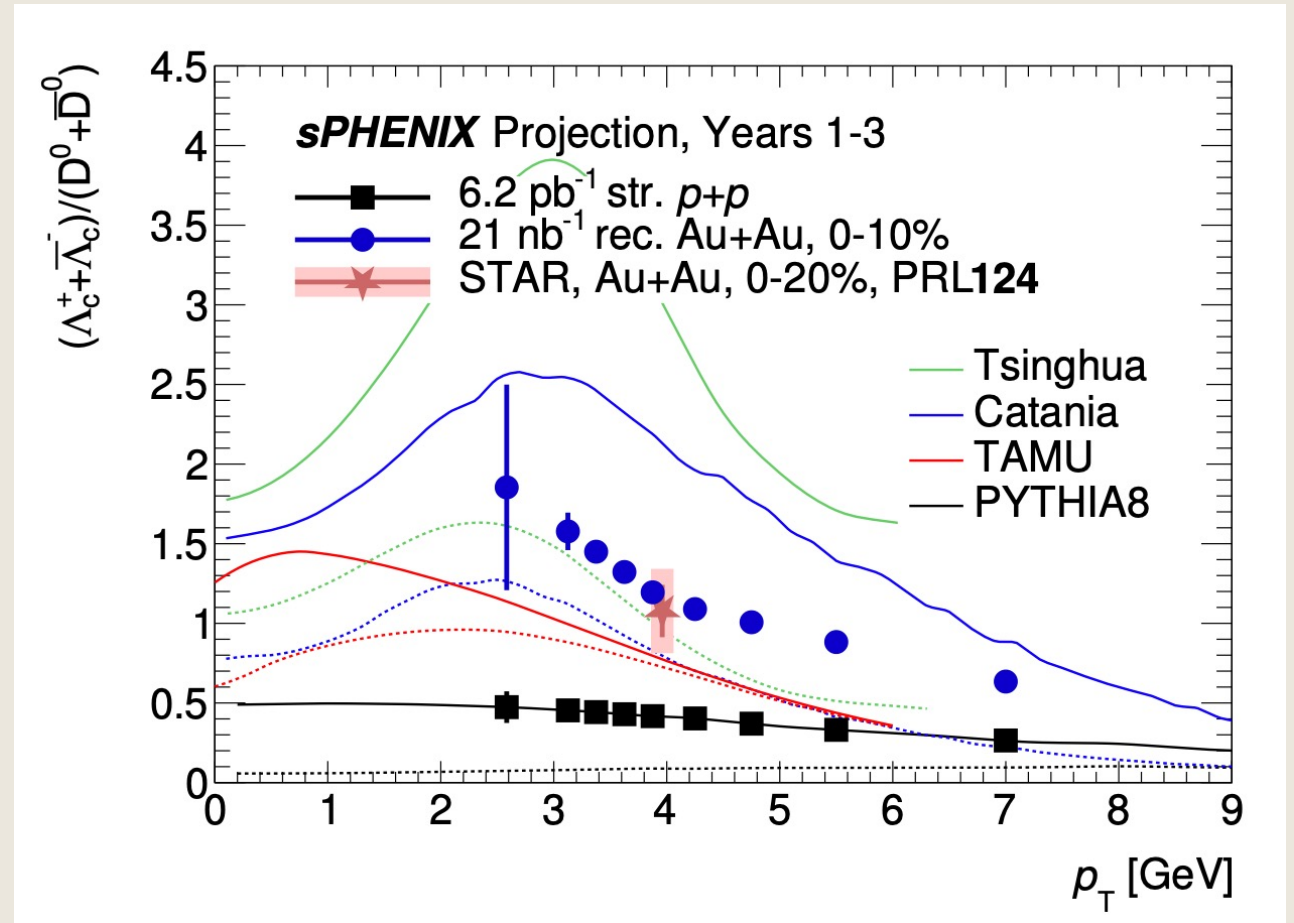

[sPHENIX Beam Use Proposal](#), 2021.

KFParticle Package

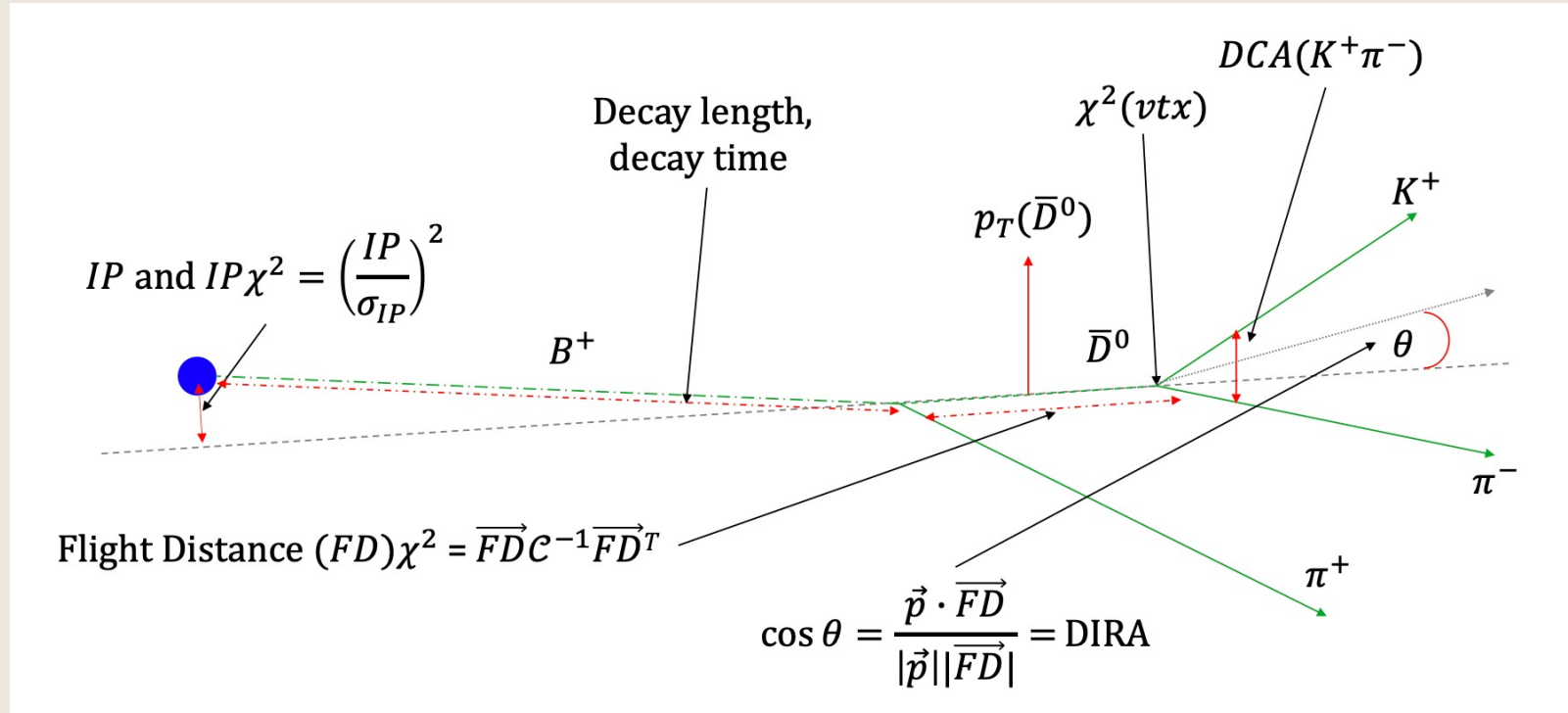

Topological cuts used to create unique PID assignments during heavy flavor reconstruction

Sacha Gorbunov and Ivan Kisel. [Reconstruction of Decayed Particles Based on the Kalman Filter](#). May 2007.
 Sebastian Tapia Araya, Cameron Dean, Jin Huang, Hideki Okawa, and Zhaozhong Shi. [First MDC1 Results from Heavy Flavor Topical Group](#). April 2021.

$$D^+ \rightarrow K^- \pi^+ \pi^+$$

$$D^{*+} \rightarrow D^0 \pi^+ \rightarrow K^- \pi^+ \pi^+ \text{ Channels}$$

50 million $c\bar{c}$
sample, p+p
 $\sqrt{s} = 200$ GeV,
no pileup

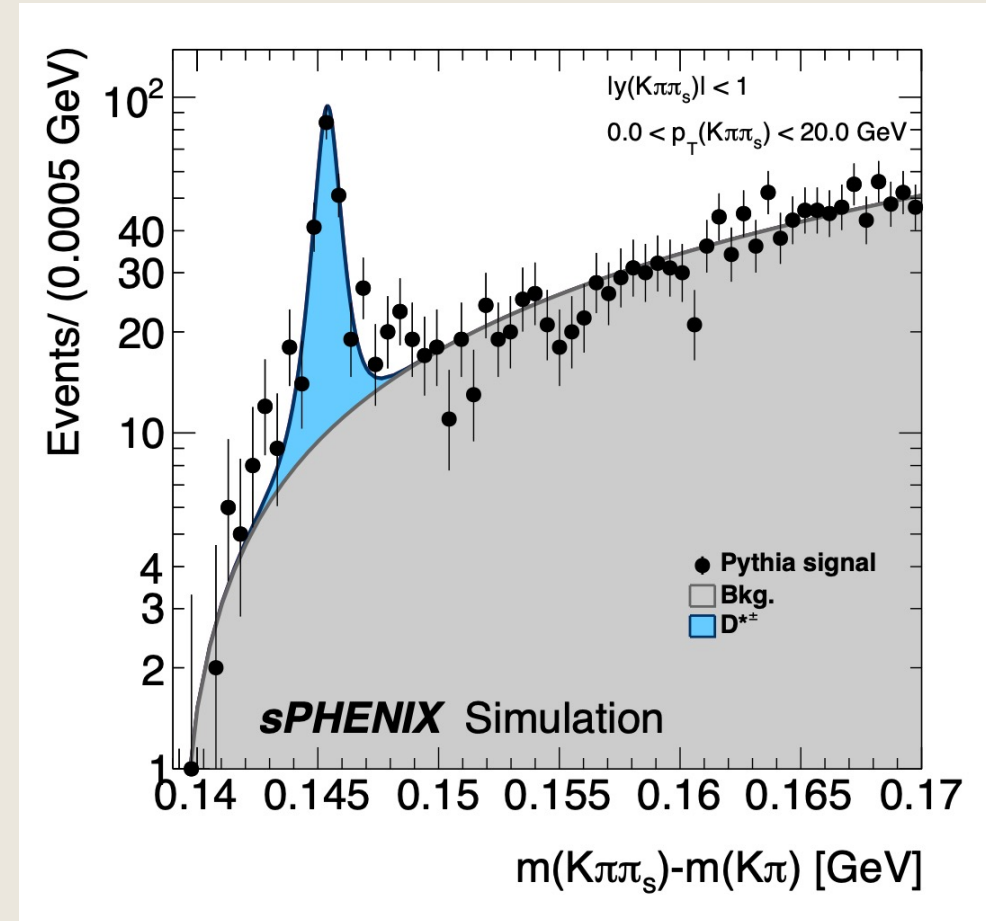
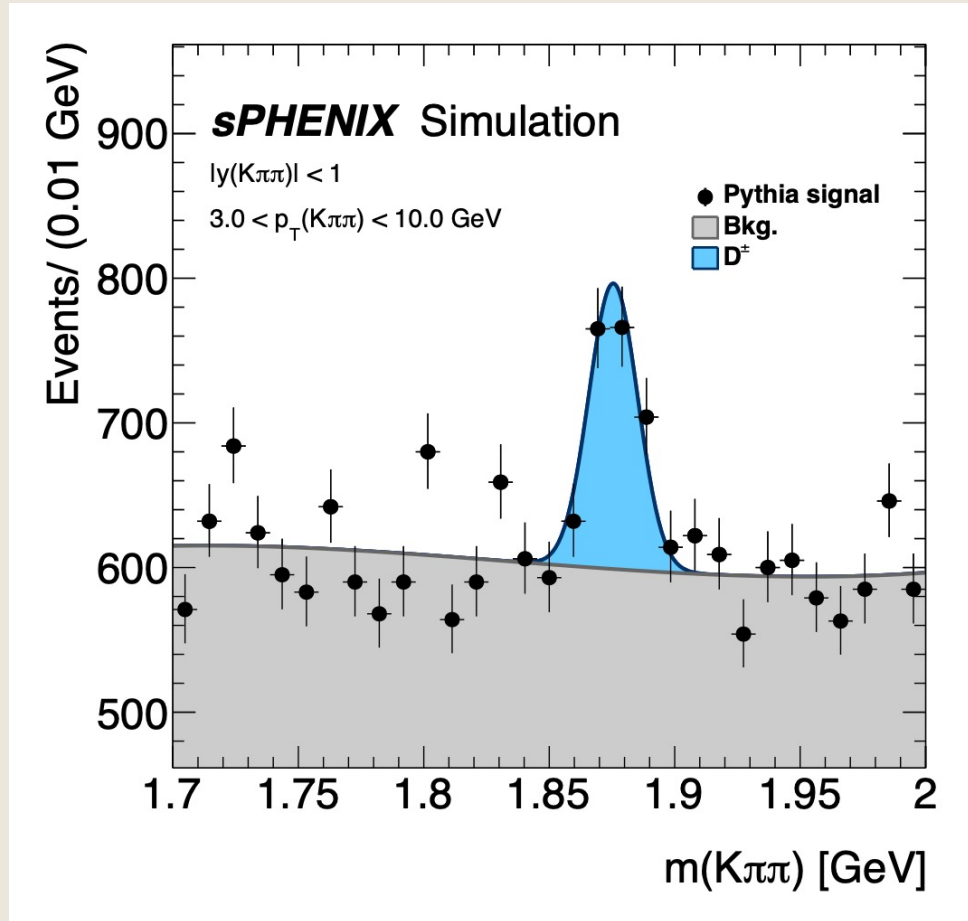

Measurements Requiring $D^0 / \overline{D^0}$ Separation

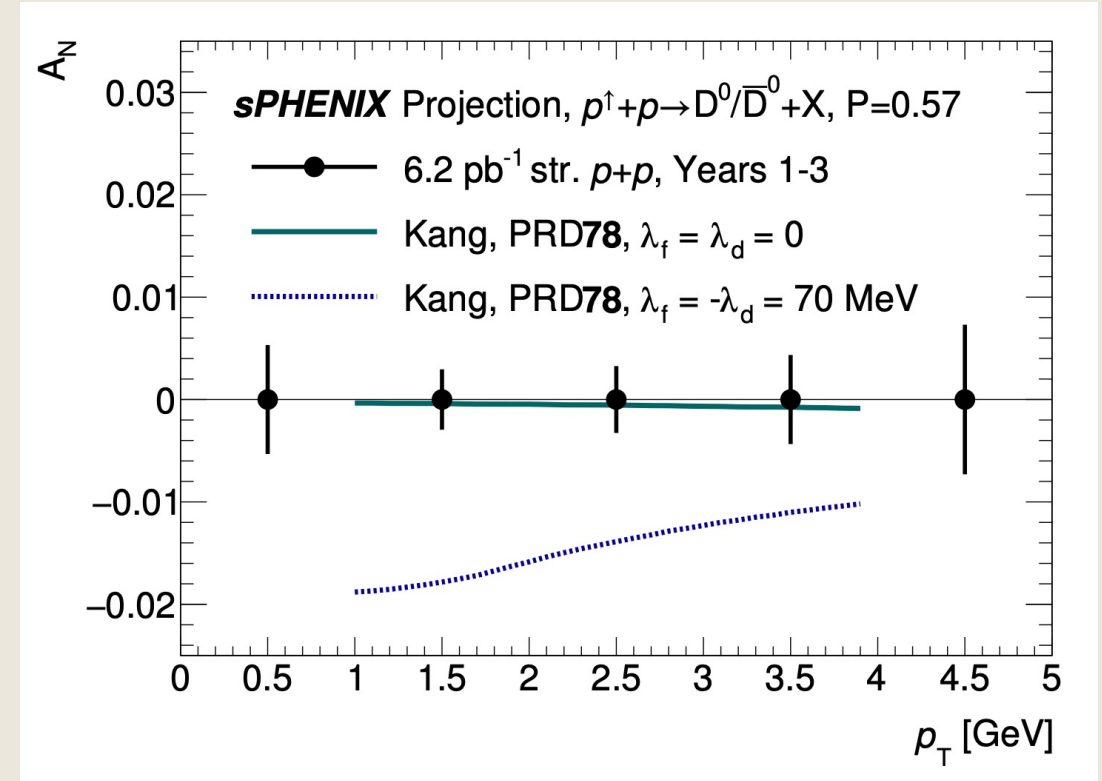
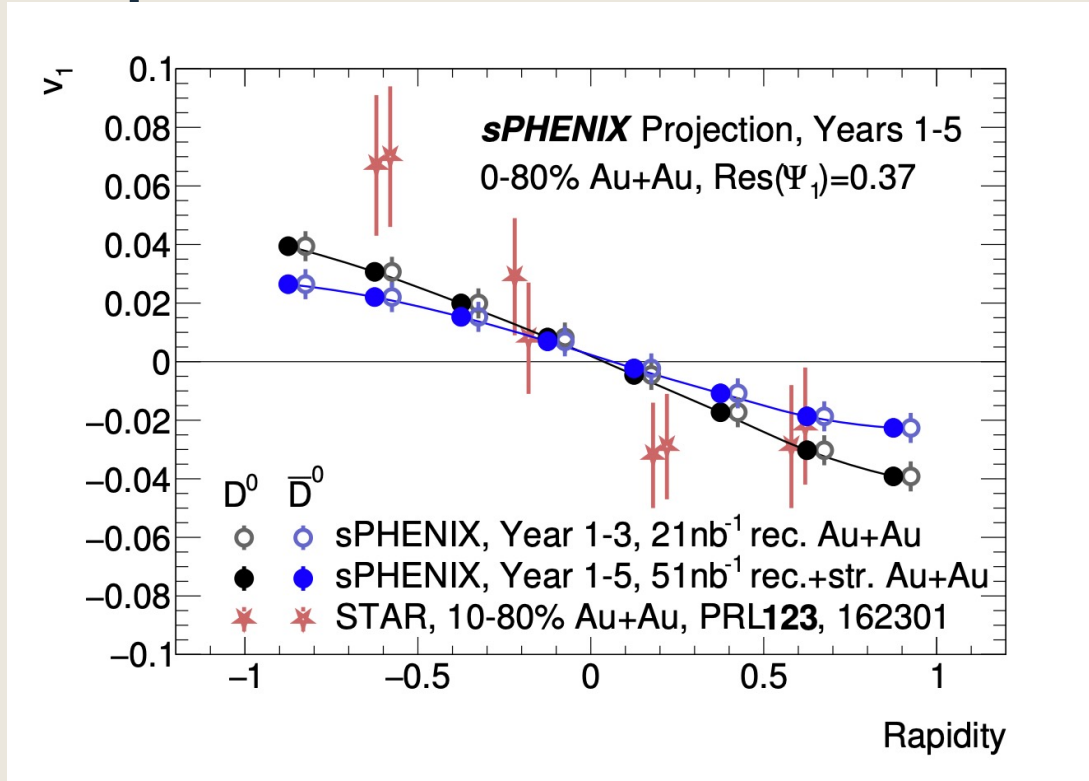

- Clean separation of v_1 allows for quantitative access to initial B field in heavy ion collisions
- Transverse single spin asymmetry (TSSA) measurements able to be separated instead of averaged over $D^0 / \overline{D^0}$ together
- Projections made prior to inclusion of EPD in sPHENIX detector

[sPHENIX Beam Use Proposal, 2021.](#)

$D^0 / \overline{D^0}$ Separation

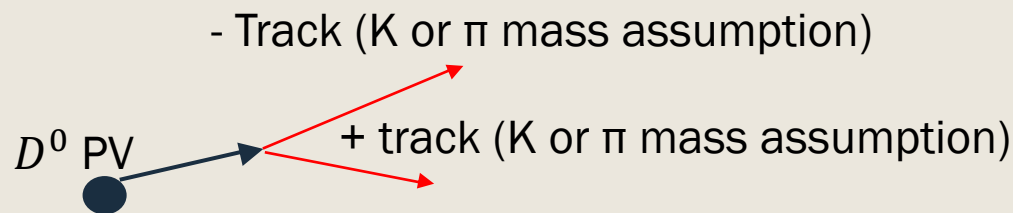

Truth D^0 Momentum

Reconstructed $D^0 / \overline{D^0}$ Momentum

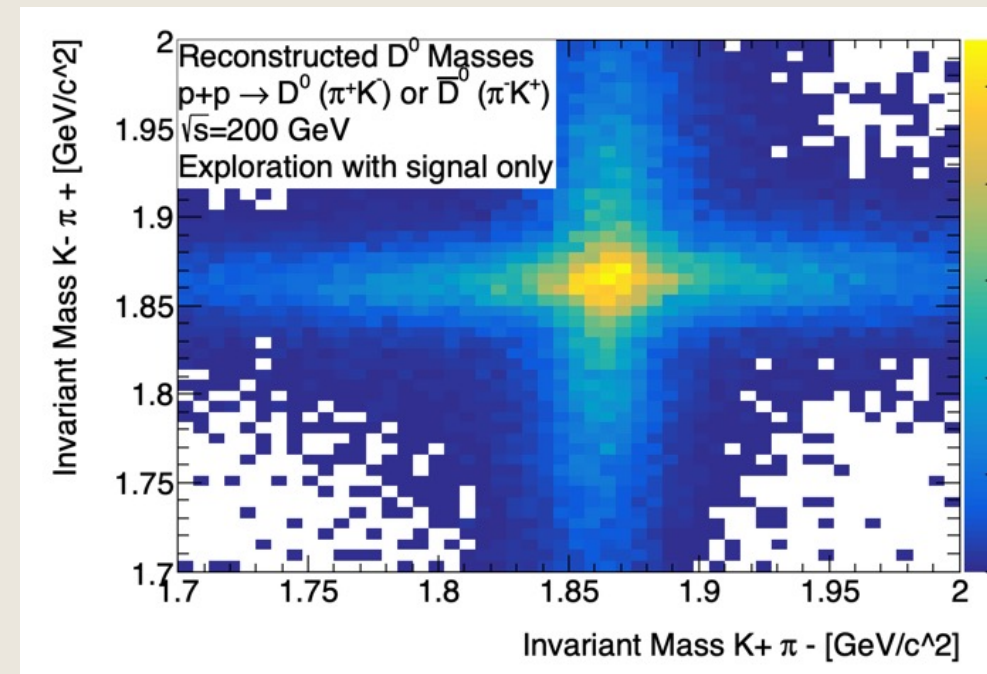
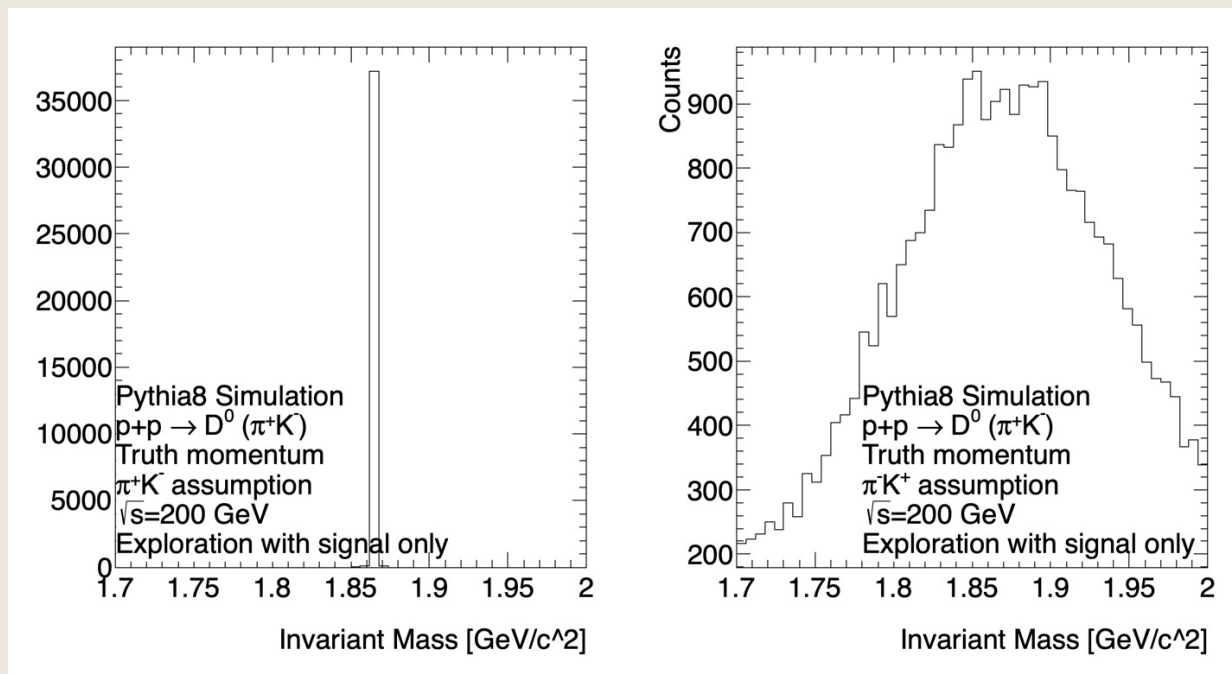

- 3 MHz p+p pileup simulation data
- Even without PID detectors, $D^0 / \overline{D^0}$ can be separated based on reconstructed invariant mass through sPHENIX's precision tracking
- Multivariate analysis ongoing, early results show clean separation at 80% signal efficiency

D^0 / \bar{D}^0 Separation

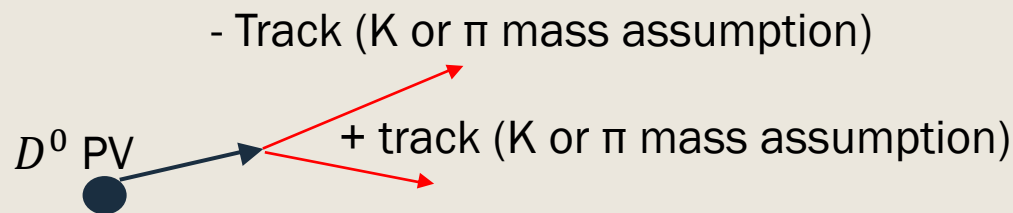

Truth D^0 Momentum

Reconstructed D^0 / \bar{D}^0 Momentum

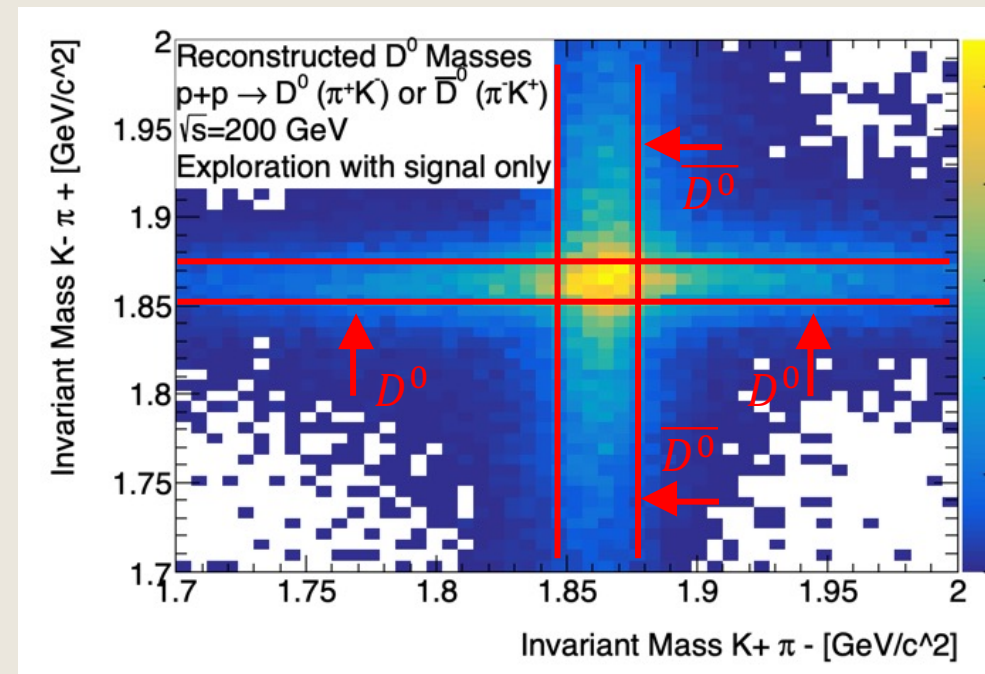
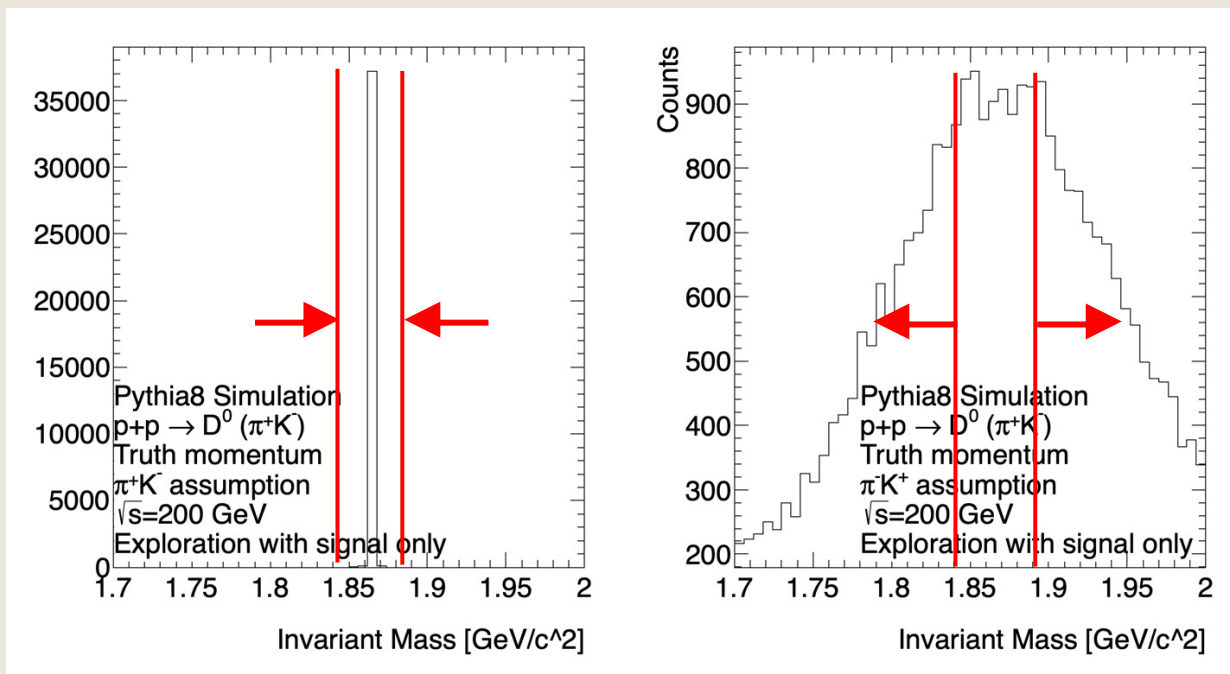

- 3 MHz p+p pileup simulation data
- Even without PID detectors, D^0 / \bar{D}^0 can be separated based on reconstructed invariant mass through sPHENIX's precision tracking
- Multivariate analysis ongoing, early results show clean separation at 80% signal efficiency

Data Taking Timeline

- oHCal and solenoid magnet completely installed
- iHCal sectors being installed in support structure to be moved and installed in assembly hall
- EMCal, TPC, INTT, and MVTX assembly all going well, installation coming soon
- Busy year ahead for the collaboration!

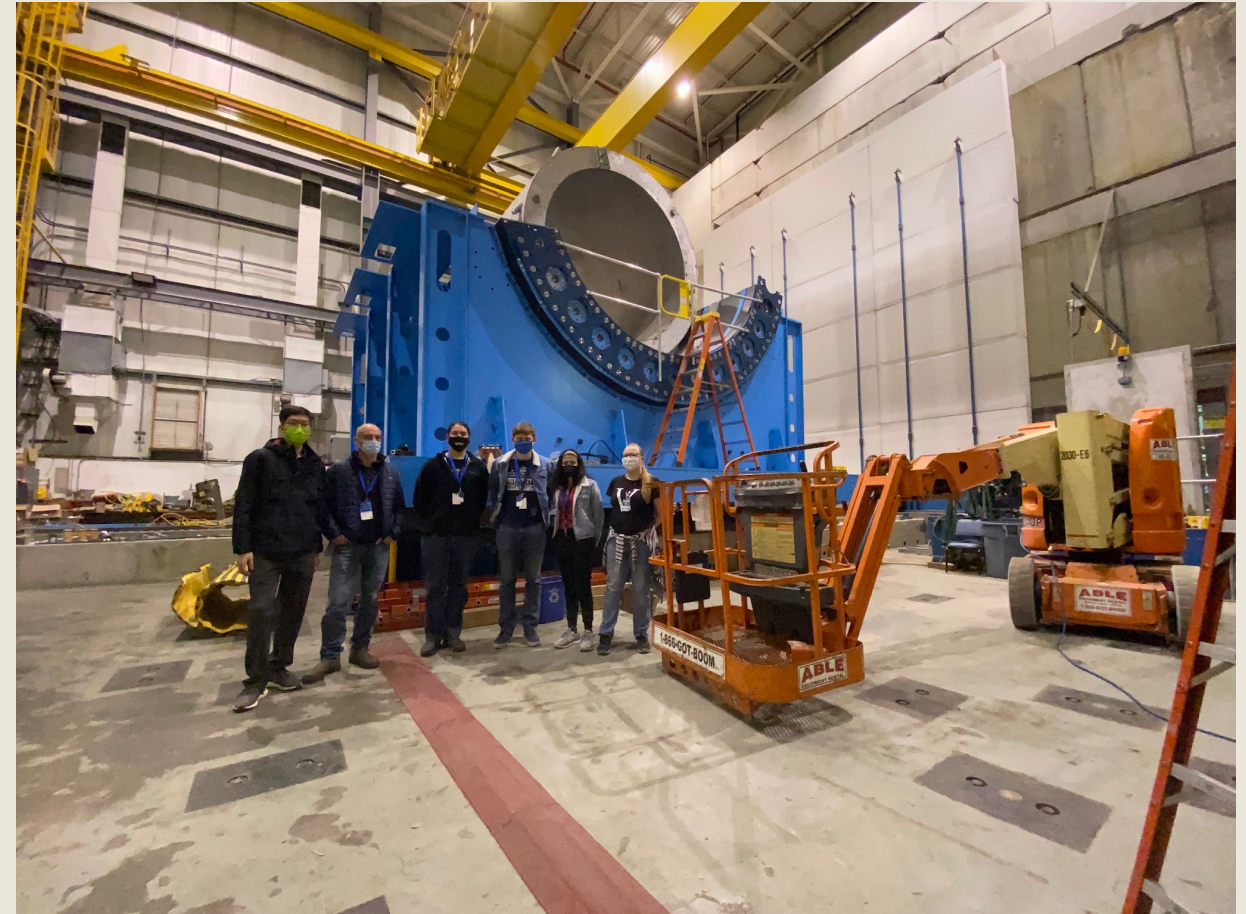

Data Taking Timeline

- oHCAL and solenoid magnet completely installed
- iHCAL sectors being installed in support structure to be moved and installed in assembly hall
- EMCal, TPC, INTT, and MVTX assembly all going well, installation coming soon
- Busy year ahead for the collaboration!



MVTX Progress

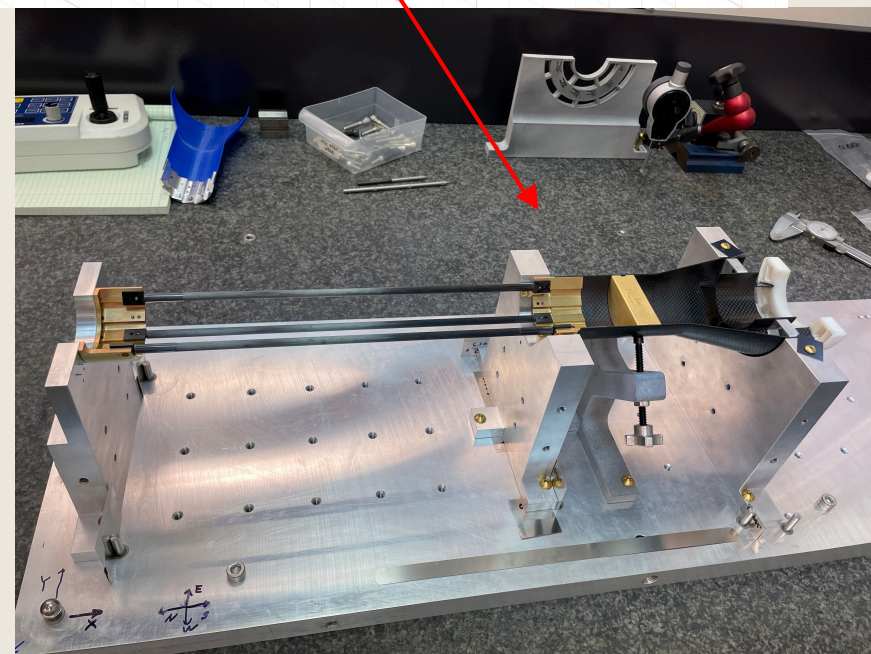
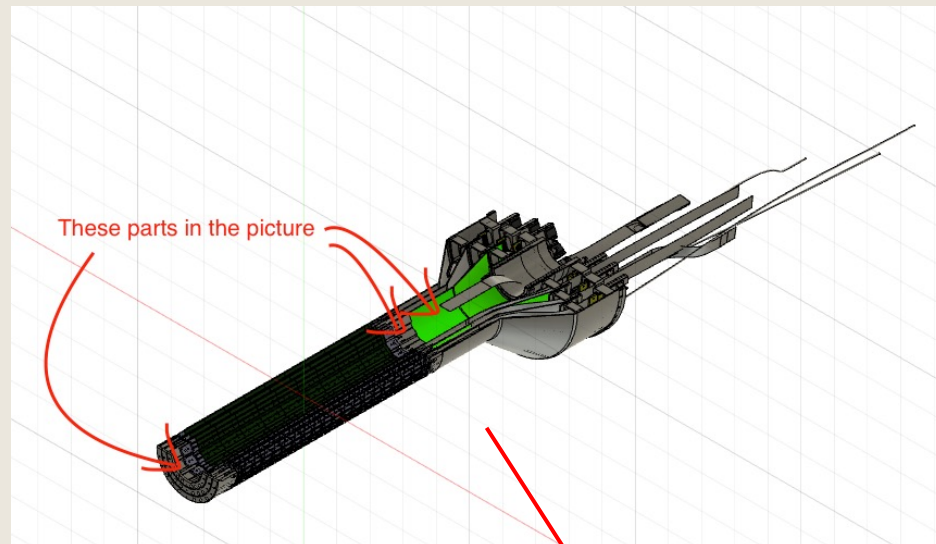

Thanks to Ho-San Ko and Cameron Dean for the pictures!

INTT Progress



[Itaru Nakagawa, Rachid Nouicer. INTT Status and Plans. Feb 2022.](#)

TPC Progress

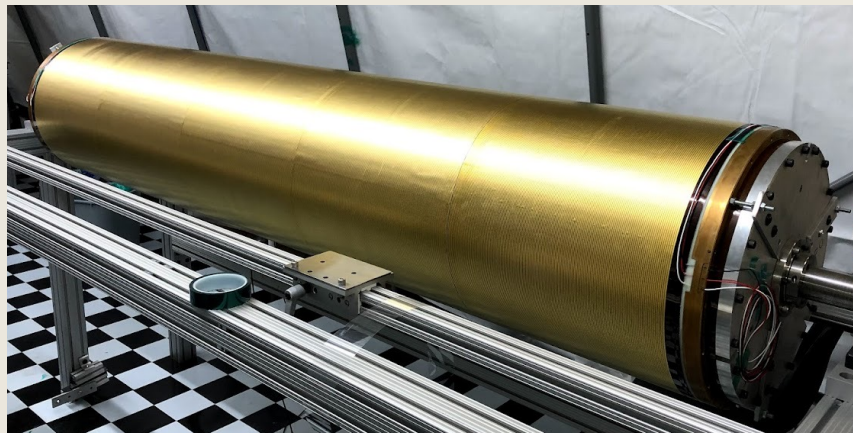
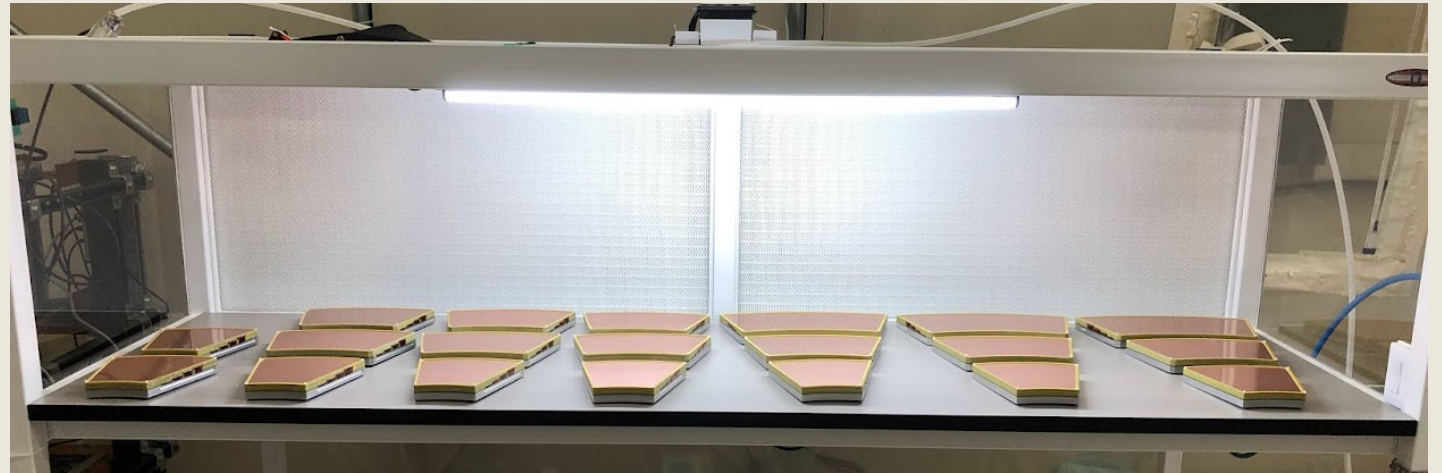
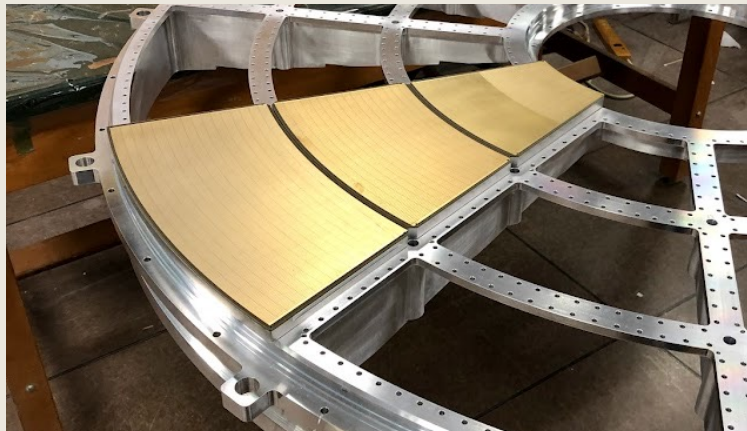

EMCal Progress



[Stoll, Sean. Status of Module Production and Sector Assembly, Feb 2022.](#)

HCal Progress

iHCal



oHCal



Summary

- sPHENIX is poised to deliver on its physics goals and projections beginning with commissioning in early 2023
- Detector assembly and installation is underway
- Reconstruction and analysis software being tested with mock data challenges (MDC)
- $D^0 / \overline{D^0}$ separation study will allow us to probe initial B field and take separate TSSA measurements
- Excited for data-taking beginning next year!

Questions/Comments?



EXTRA: EPD Resolution

- Initial estimate of 50% EP resolution for AuAu collisions regardless of centrality for BUP projections
 - Very optimistic in 0-10% range based on current values

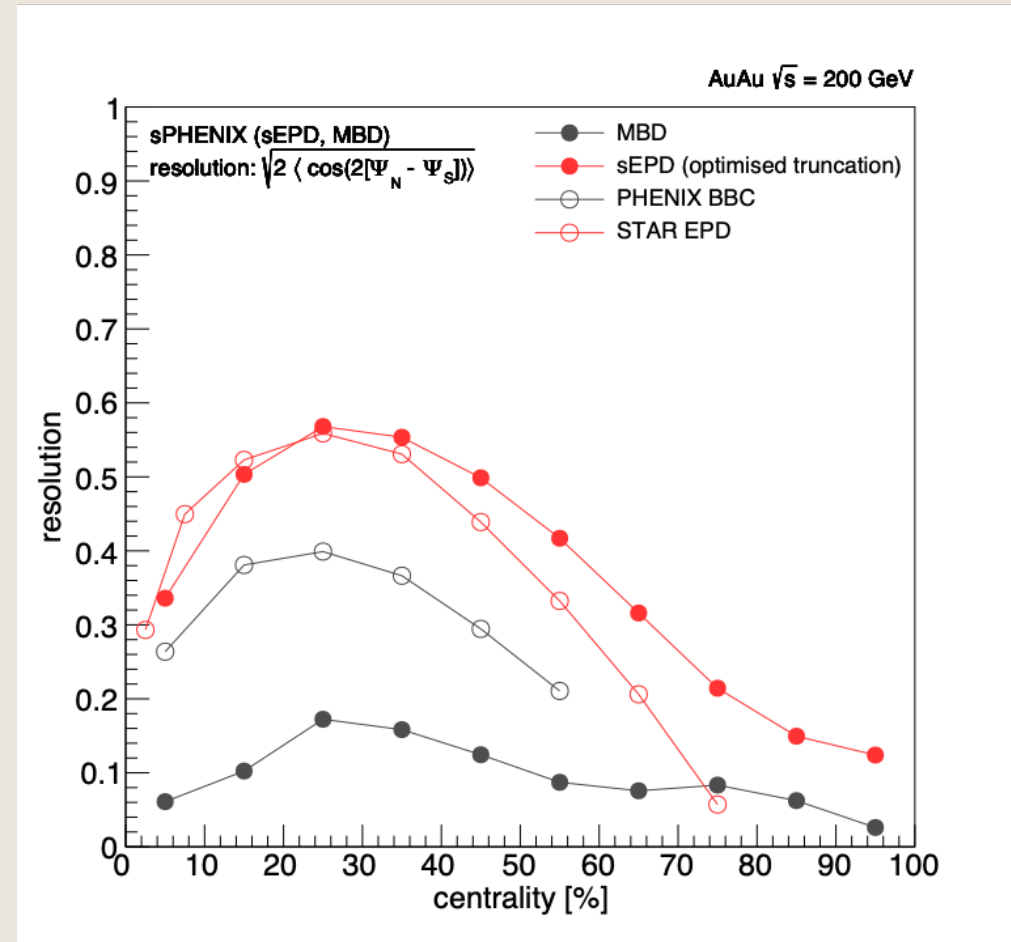

EXTRA: D^0 / \bar{D}^0 Separation

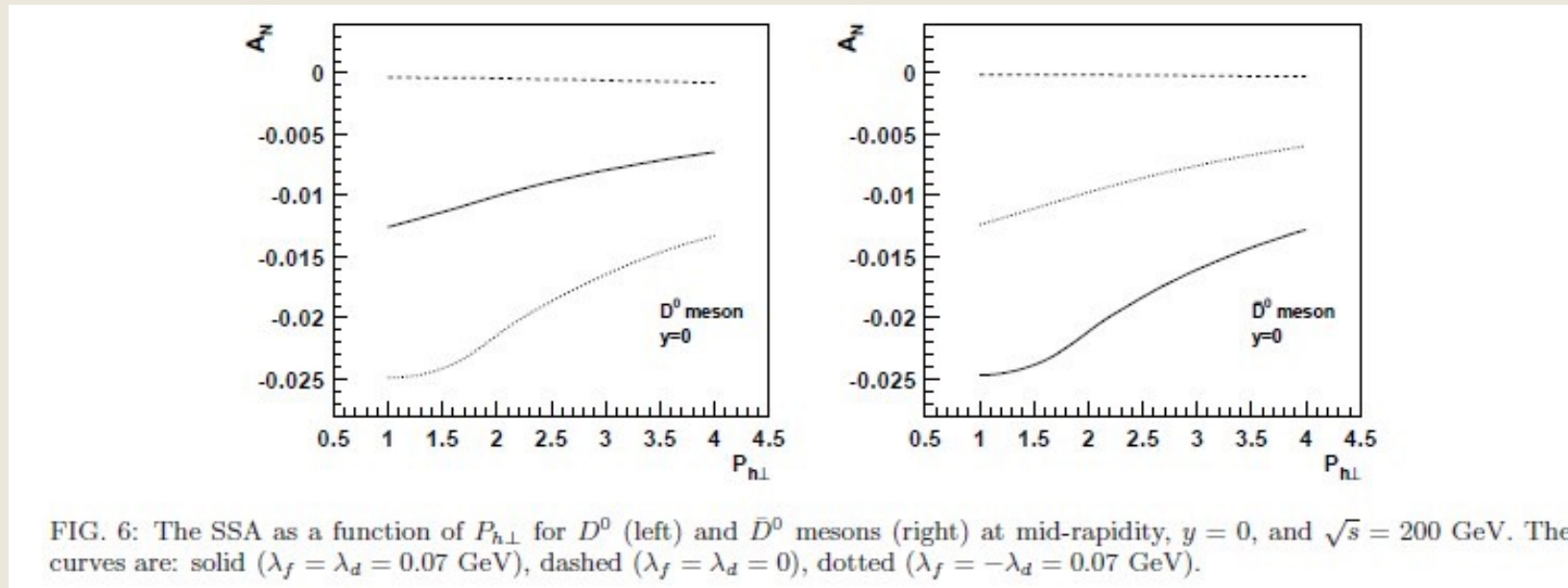

EXTRA: Recent Progress - Mock Data Challenge 1

- MDC1 - First use of complete Day-1 analysis chain
 - *Pythia 8.3 event generation, 200 GeV collisions*
 - *Simulation/digitization with full detector description*
 - *Reconstruction using A Common Tracking Software (ACTS) and KFParticle*
 - *Analysis over inclusive HF signal samples*
 - *50 million $c\bar{c}$ events $\sim 0.2 \text{ pb}^{-1}$ or four-day data taking*
 - *50 million $b\bar{b}$ events $\sim 30 \text{ pb}^{-1}$ and 6x the integrated luminosity of Min Bias $p+p$ collision data in first three-year run plan*
 - *Single event multiplicity, no pile-up from collisions with different bunch crossings*
 - *Light flavor background still being produced, not included here*

EXTRA: $c, b \rightarrow D^0 \rightarrow K^{\mp} \pi^{\pm}$ Channel

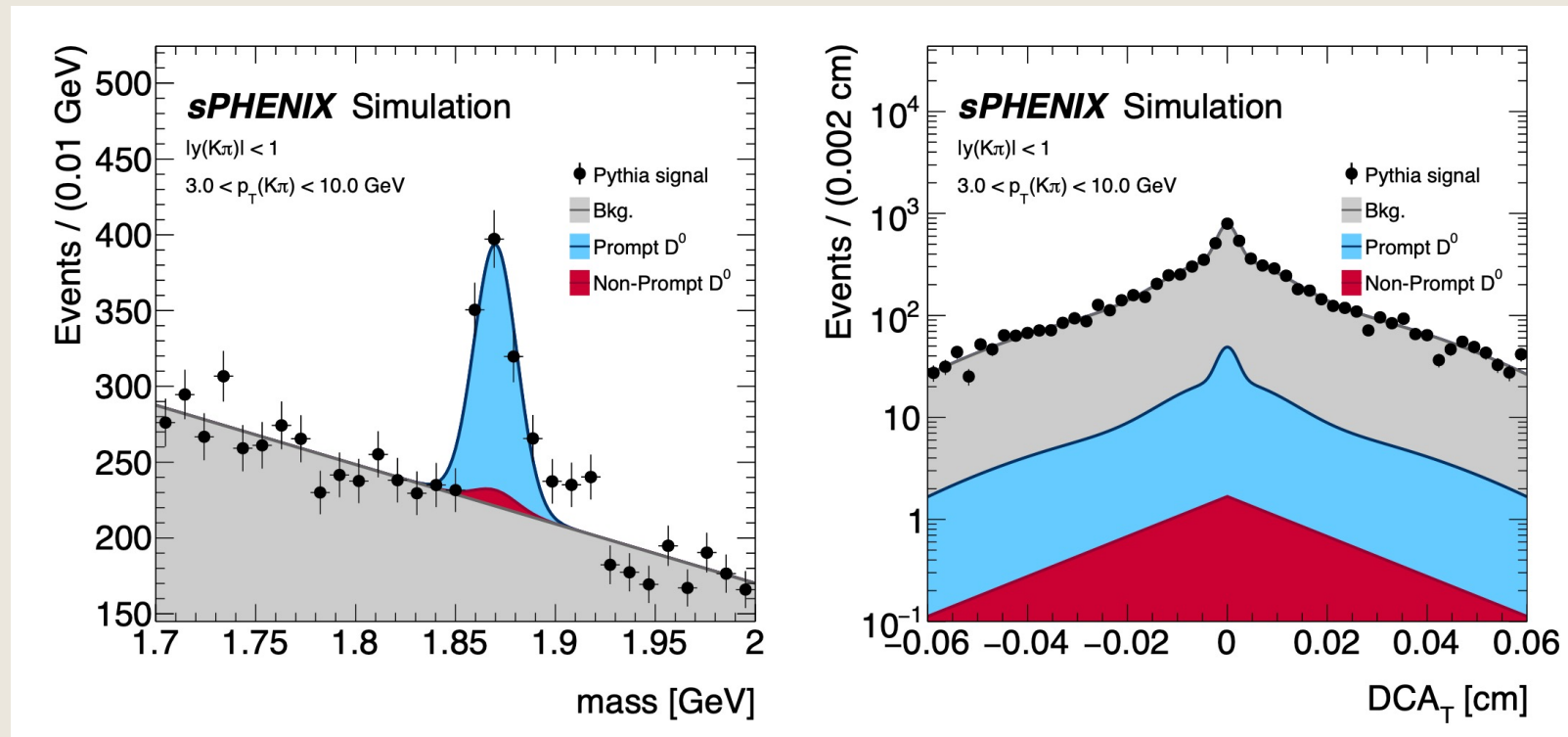

EXTRA: $D_S^+ \rightarrow K^+ K^- \pi^+$

$D_S^+ \rightarrow \phi \pi^+ \rightarrow K^+ K^- \pi^+$ Channels

