

Uso de datos públicos del CERN en el aula

Una invitación y una microguía

Motivación:

Imaginemos que vais a una clase de pintura y os encontráis esto:

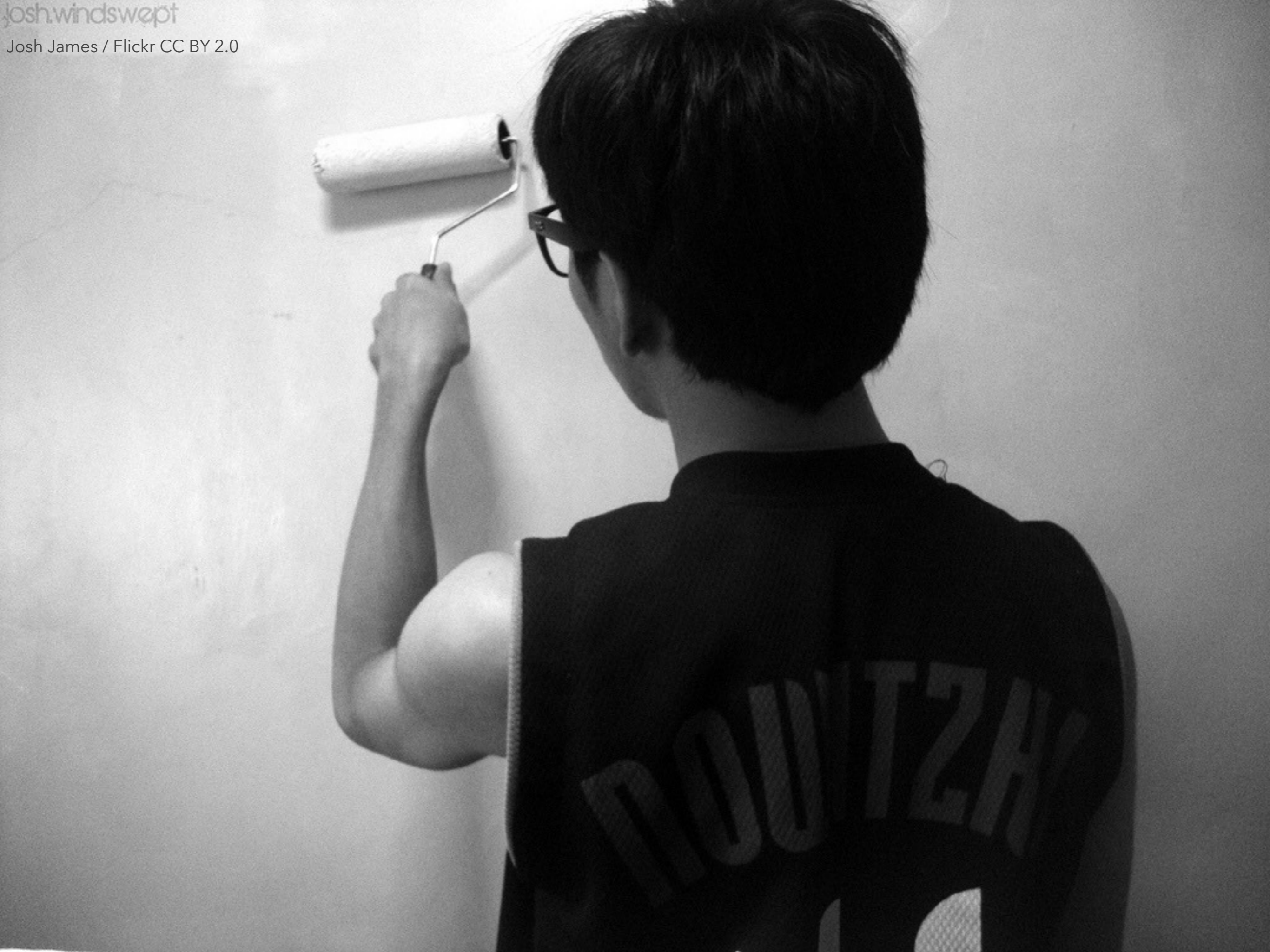

o de matemáticas:

$$\sqrt{6.42.53}$$

$$\underline{-4}$$

$$242$$

$$\underline{-225}$$

$$01753$$

$$\underline{-1509}$$

$$0244$$

$$253$$

$$2 \times 2 = 4$$

$$45 \times 5 = 225$$

$$503 \times 3 = 1509$$

o de física...

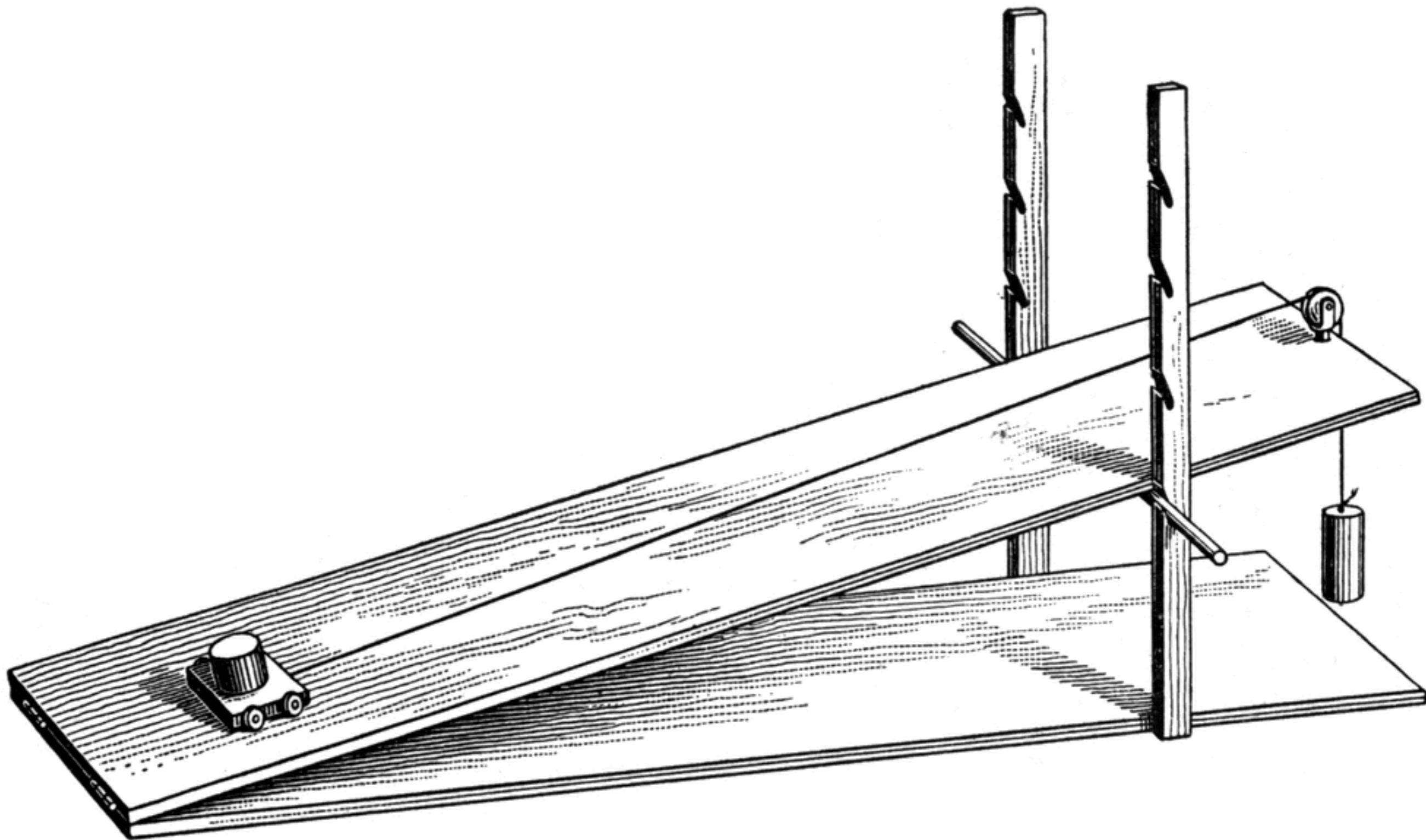

Horace H. Cummings, *Nature Study by Grades* (New York: America Book Company, 1909) 187

Copyright © 2004-2019 Florida Center for Instructional Technology. *ClipArt ETC* is a part of the Educational Technology Clearinghouse and is produced by the Florida Center for Instructional Technology, College of Education, University of South Florida.

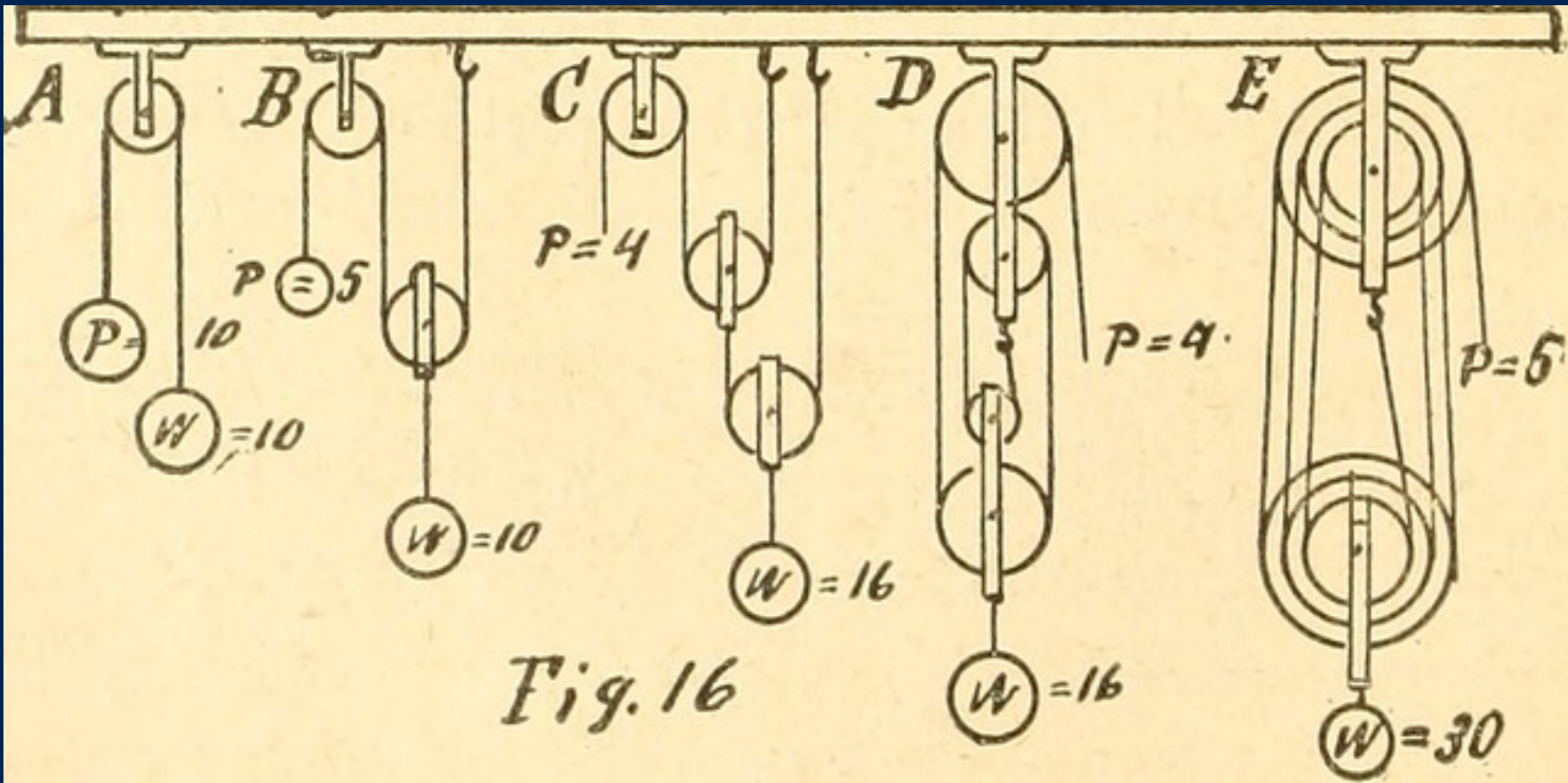

Image from page
45 of "Elementary
lessons in the
physics of
agriculture" (1894)

Hay alternativas...





Diana González Yuste
The October Press, Alicante





Begoña V.

Flickr CC BY-NC-SA 2.0

Motivación



Las colisiones no son como las de los coches...

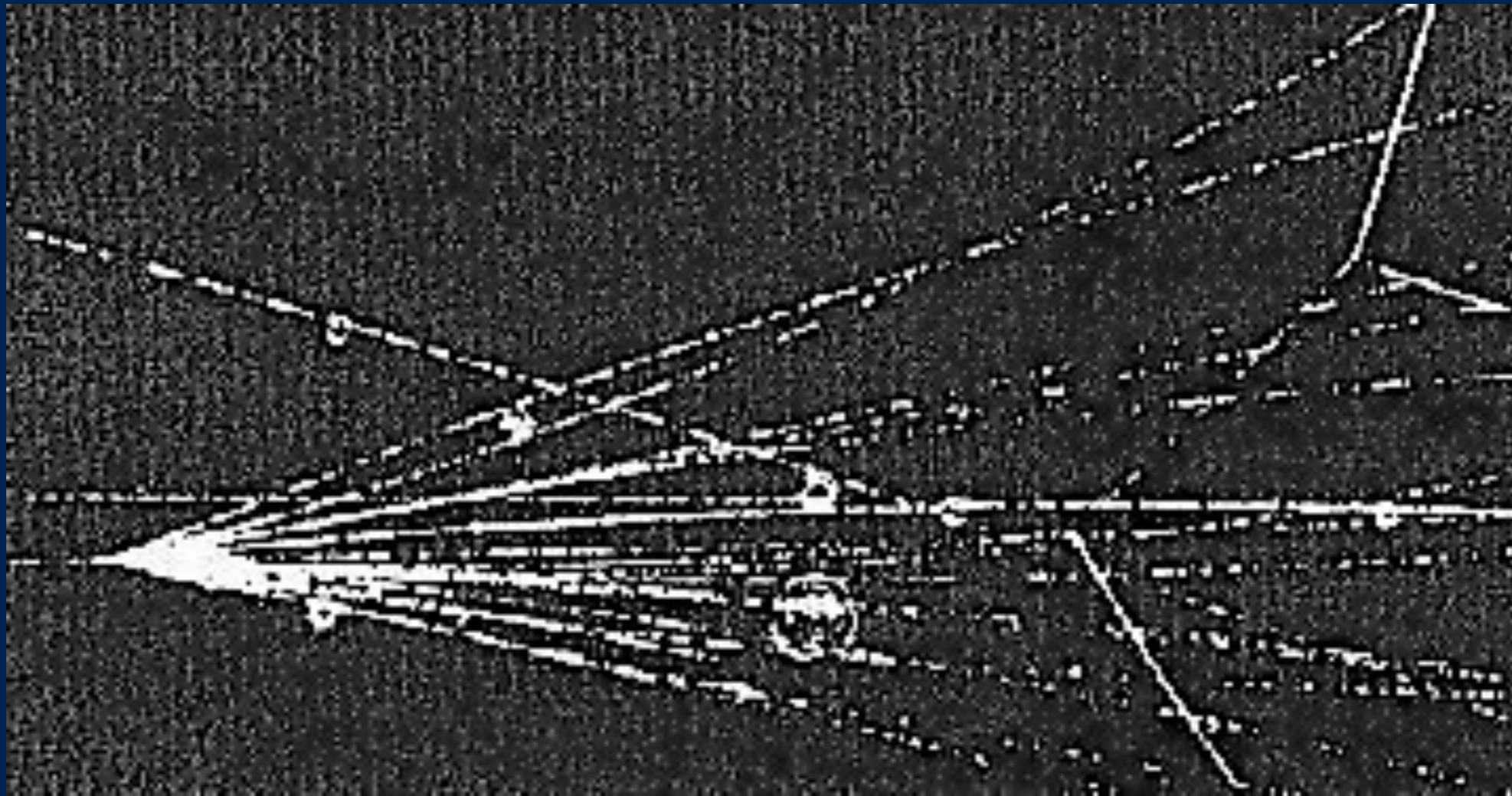

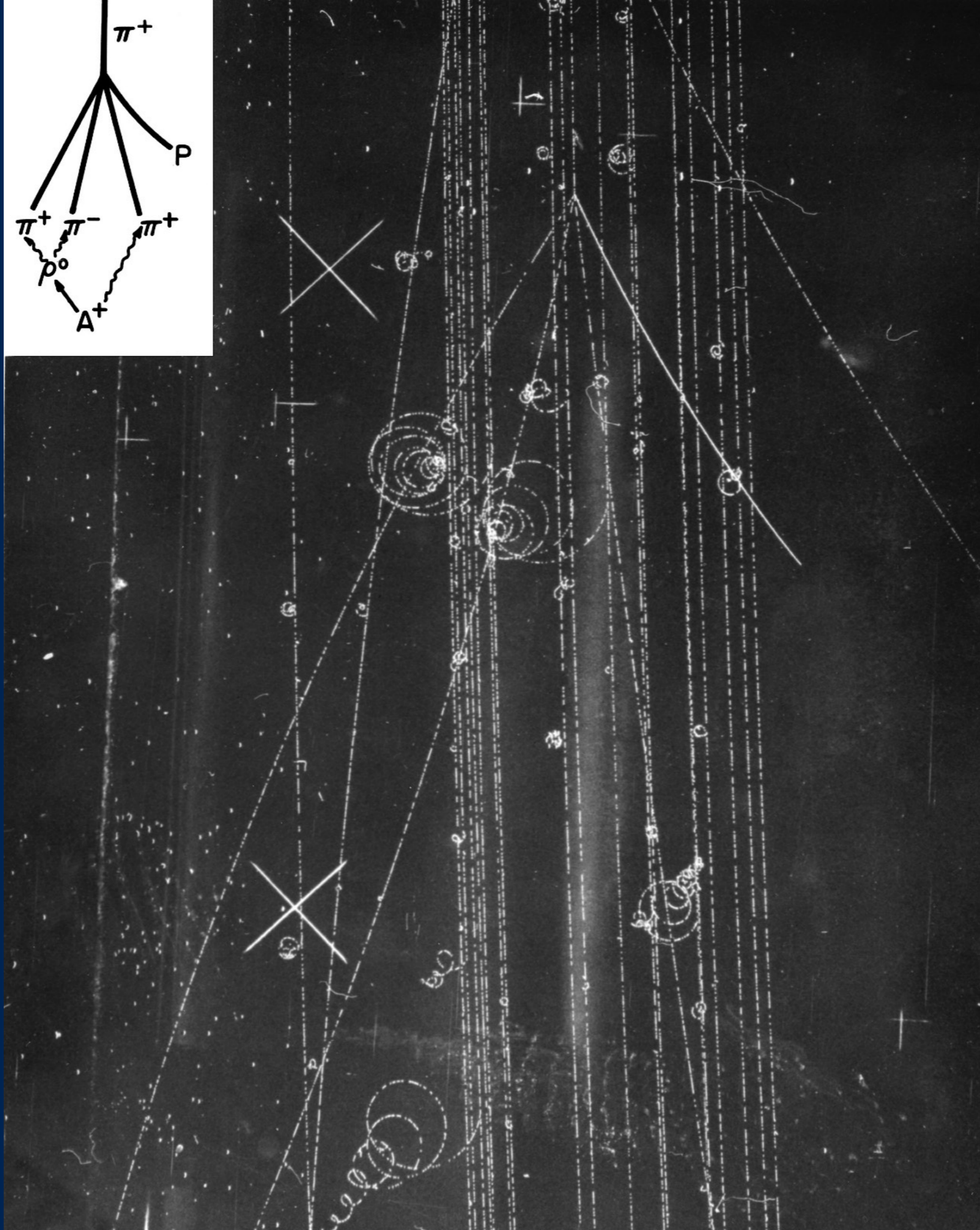
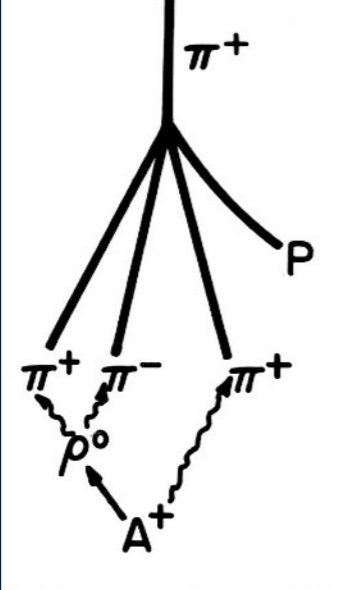

Bubble chamber event. Inset diagram indicating form of A-plus production in peripheral collision (performed at Brookhaven National Laboratory). Photograph taken January 31, 1964. Bubble Chamber-1348

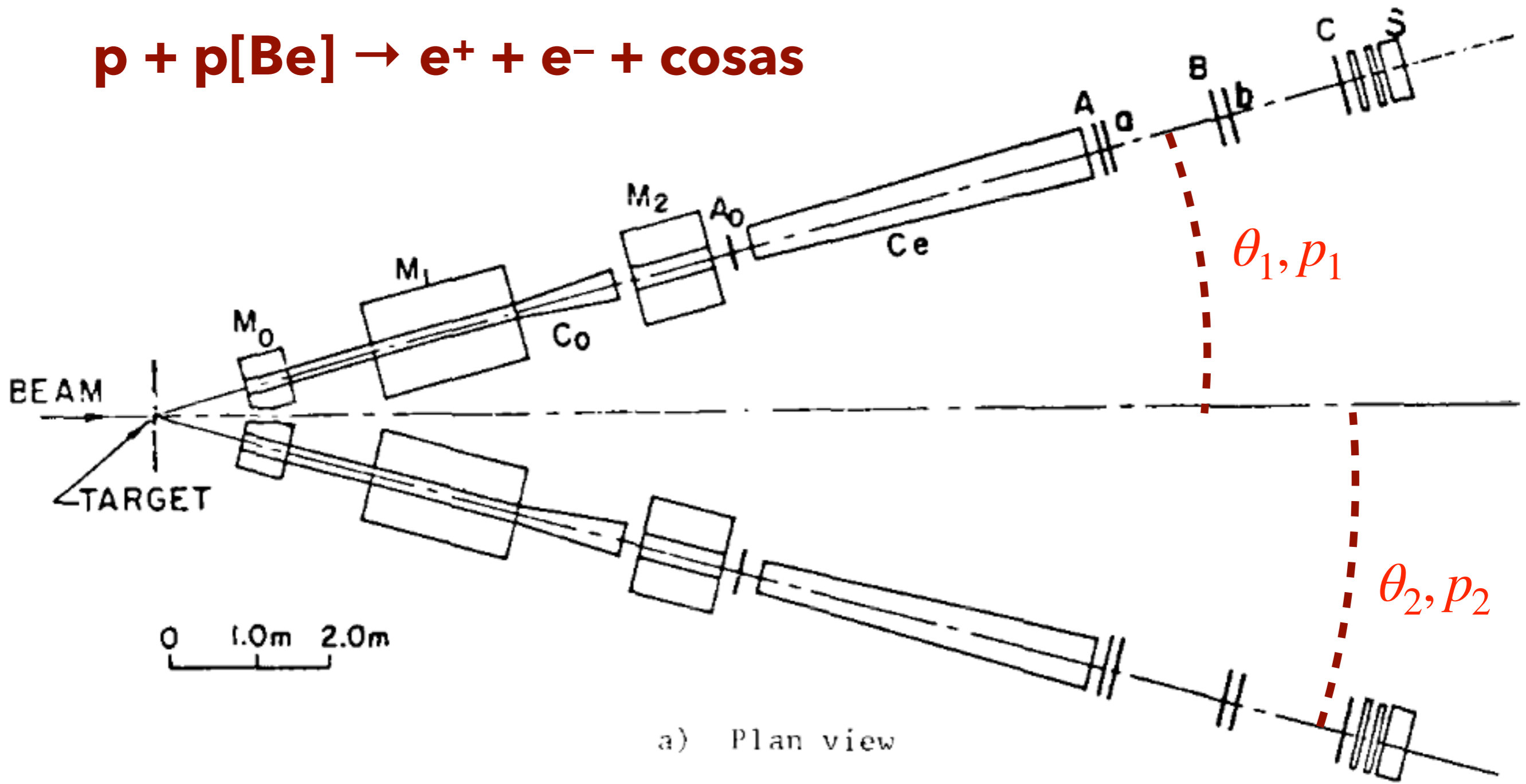

<https://www.nobelprize.org/uploads/2018/06/ting-lecture.pdf>

Si resulta que $p + p \rightarrow X \rightarrow e^+ + e^-$ la masa m de X será:

$$m^2 = m_1^2 + m_2^2 + 2[E_1 E_2 - p_1 p_2 \cos(\theta_1 + \theta_2)]$$

Experimental Observation of a Heavy Particle J^\dagger

J. J. Aubert, U. Becker, P. J. Biggs, J. Burger, M. Chen, G. Everhart, P. Goldhagen, J. Leong, T. McCorrison, T. G. Rhoades, M. Rohde, Samuel C. C. Ting, and Sau Lan Wu
*Laboratory for Nuclear Science and Department of Physics, Massachusetts Institute of Technology,
Cambridge, Massachusetts 02139*

and

Y. Y. Lee

Brookhaven National Laboratory, Upton, New York 11973

(Received 12 November 1974)

We report the observation of a heavy particle J , with mass $m = 3.1$ GeV and width approximately zero. The observation was made from the reaction $p + \text{Be} \rightarrow e^+ + e^- + x$ by measuring the e^+e^- mass spectrum with a precise pair spectrometer at the Brookhaven National Laboratory's 30-GeV alternating-gradient synchrotron.

This experiment is part of a large program to study the behavior of timelike photons in $p + p \rightarrow e^+ + e^- + x$ reactions¹ and to search for new particles which decay into e^+e^- and $\mu^+\mu^-$ pairs.

daily with a thin Al foil. The beam spot size is 3×6 mm², and is monitored with closed-circuit television. Figure 1(a) shows the simplified side view of one arm of the spectrometer. The two

J. J. Aubert, U. Becker, P. J. Biggs, J. Burger, M. Chen, G. Everhart, P. Goldhagen, J. Leong, T. McCorrison, T. G. Rhoades, M. Rohde, Samuel C. C. Ting, Sau Lan Wu, and Y. Y. Lee

Phys. Rev. Lett. 33, 1404 – Published 2 December 1974

We report the observation of a heavy particle J , with mass $m=3.1$ GeV and width approximately zero. The observation was made from the reaction $p+\text{Be}\rightarrow e^+e^-+x$ by measuring the e^+e^- mass spectrum with a precise pair spectrometer at the Brookhaven National Laboratory's 30-GeV alternating-gradient synchrotron.

Received 12 November 1974

Discovery of a Narrow Resonance in e^+e^- Annihilation

J. -E. Augustin *et al.*

Phys. Rev. Lett. 33, 1406 – Published 2 December 1974

Physics See Focus story: [Landmarks—The Charming Debut of a New Quark](#)

An article within the collection: [Letters from the Past - A PRL Retrospective](#)

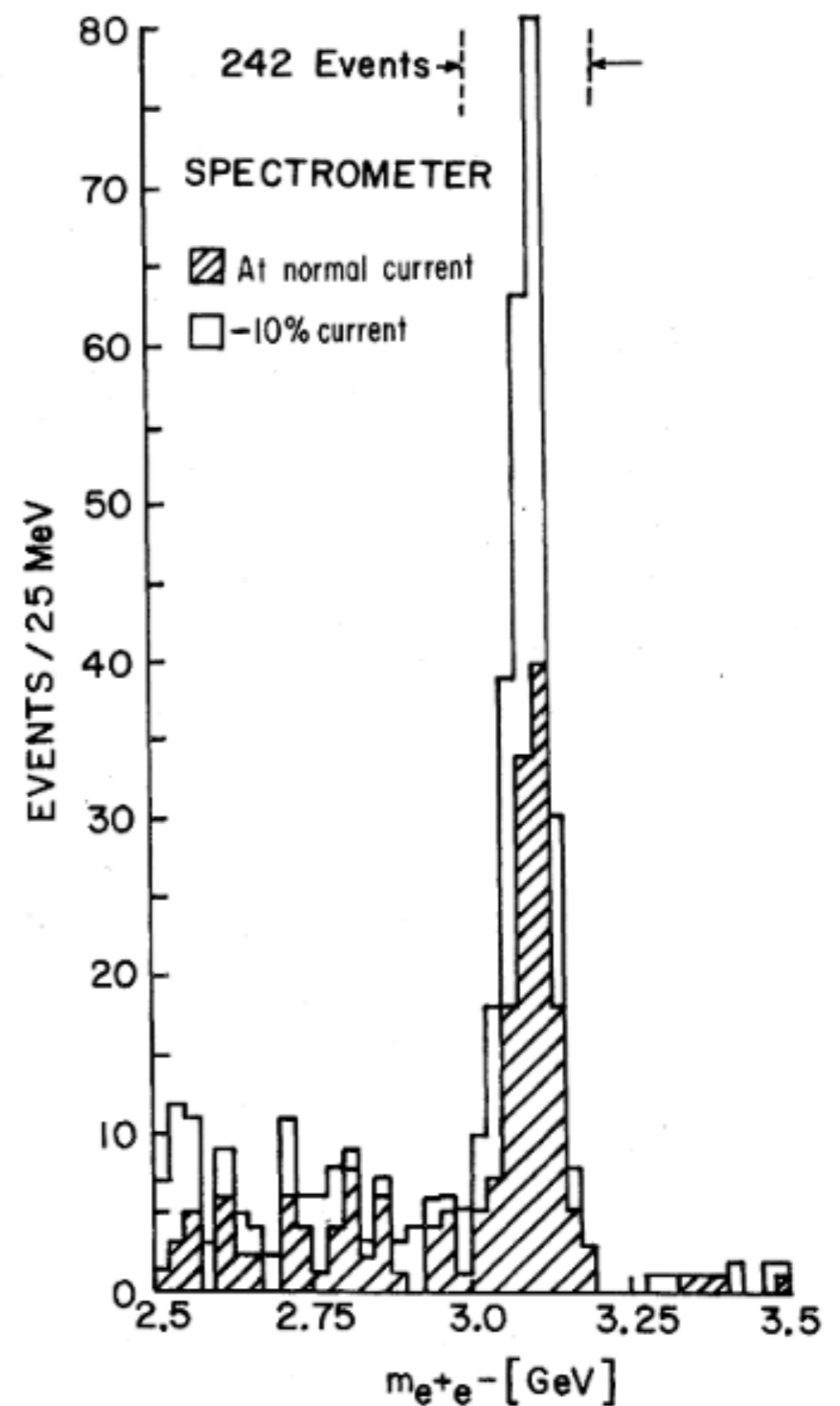

FIG. 2. Mass spectrum showing the existence of J . Results from two spectrometer settings are plotted showing that the peak is independent of spectrometer currents. The run at reduced current was taken two months later than the normal run.

Ahora nos toca a nosotros

Gracias a CMS que nos cede sus parejas de muones o electrones, usados, pero muy bien seleccionados y limpios...



CMS Experiment at the LHC, CERN
Data recorded: 2015-Oct-30 19:23:54.631552 GMT
Run / Event / LS: 260424 / 211873064 / 115

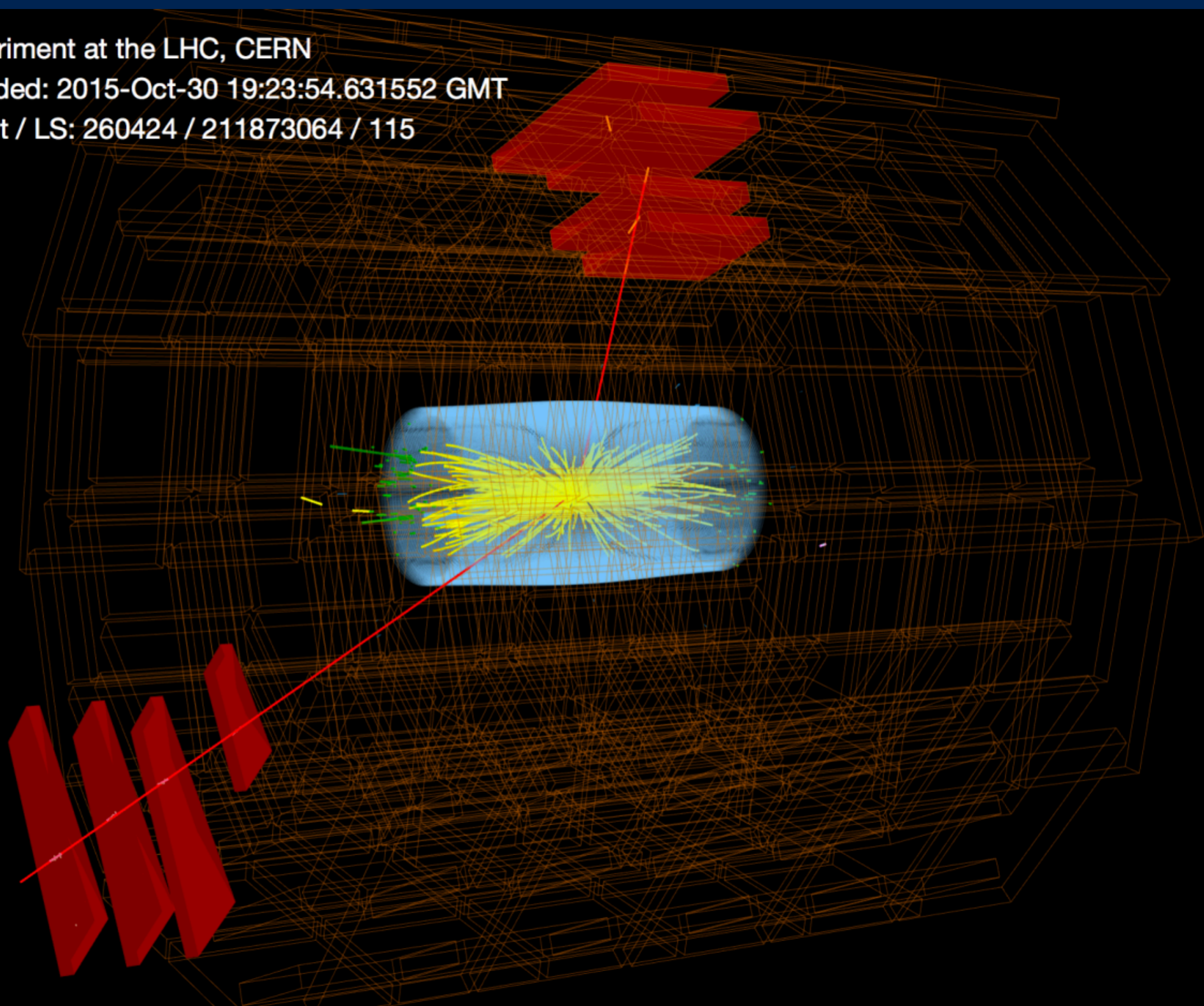



CMS Experiment at the LHC, CERN

Data recorded: 2015-Oct-30 19:23:54.631552 GMT

Run / Event / LS: 260424 / 211873064 / 115

p

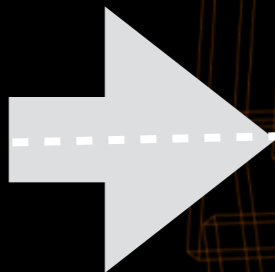

p

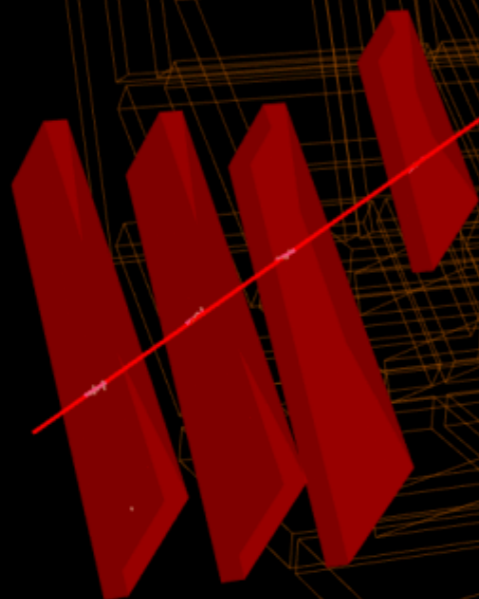
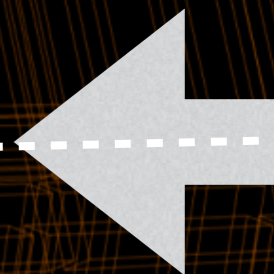

μ^-

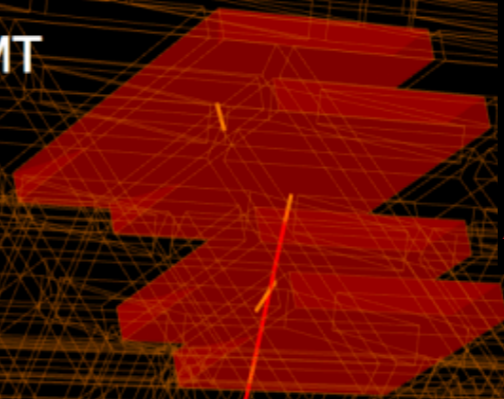

μ^+

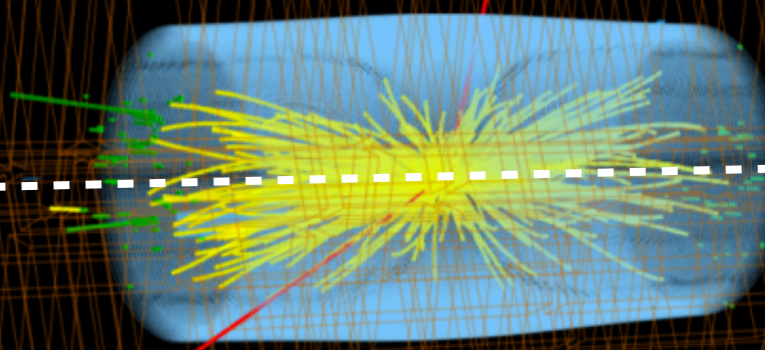

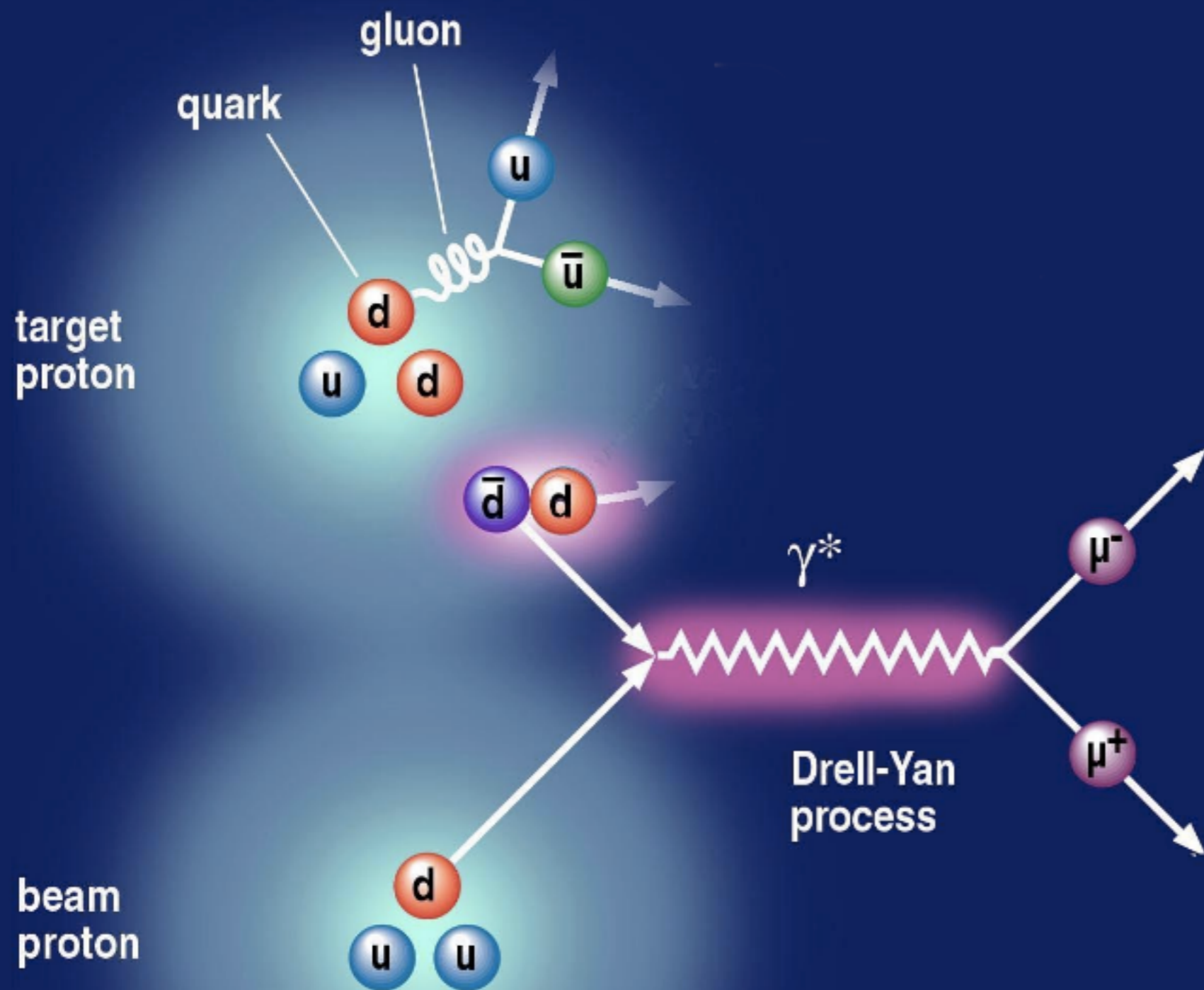

34 fb⁻¹ (13 TeV, 2018)

CMS
Preliminary

Online Reconstructed Dimuon Events
 $p_{T(\mu)} > 3$ GeV, $\eta(\mu) < 2.4$, opposite sign

Events/GeV

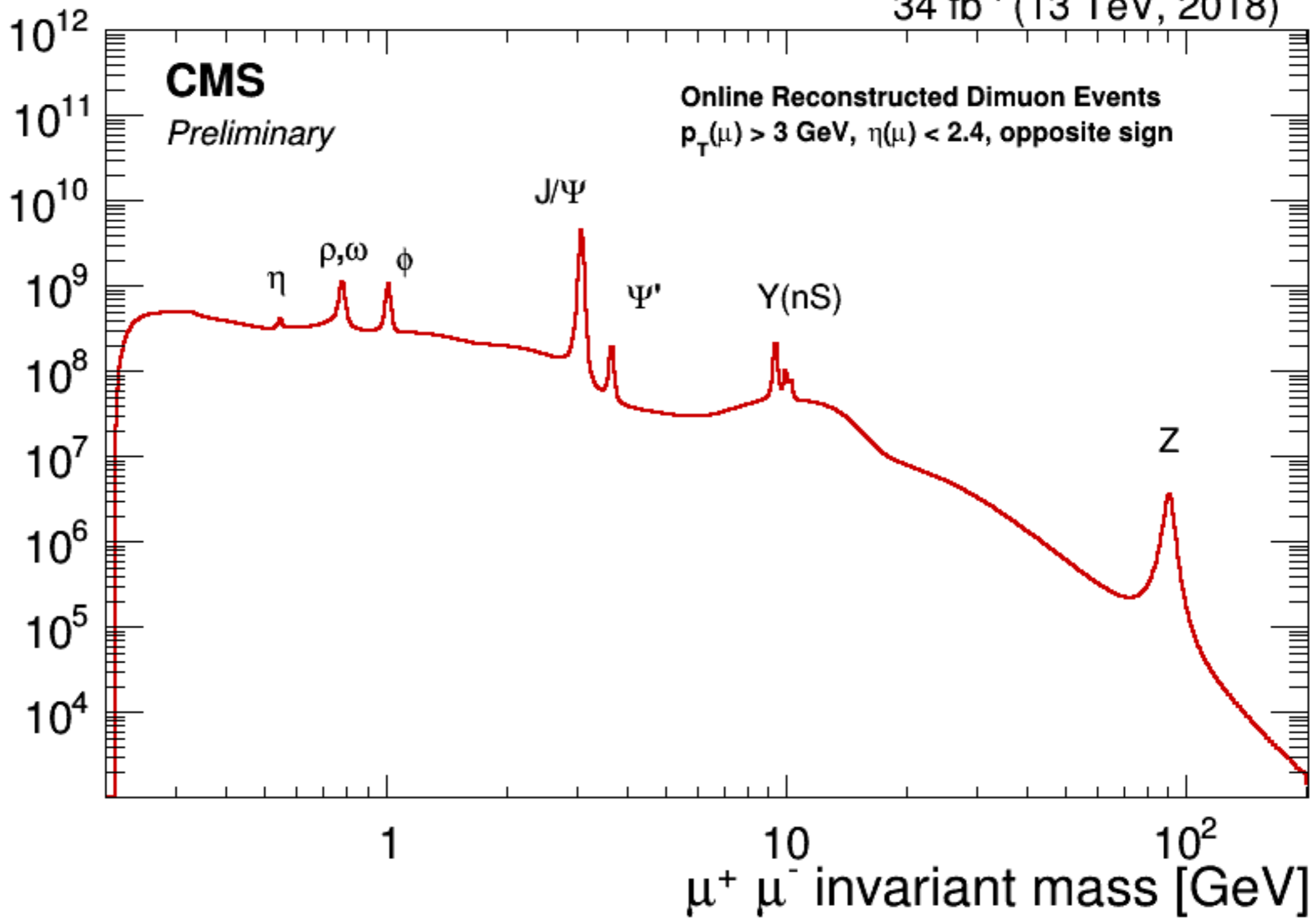

In 1969, John Iliopoulos and Luciano Maiani came to Harvard as research fellows. Together, we found the arguments that predicted the existence of charmed hadrons. Much of my later work was done in collaboration with Alvaro de Rujúla or Howard Georgi.

In early 1974, we predicted that charm would be discovered in neutrino physics or in $e^+ e^-$ annihilation. So it was.

With the discovery of the J/Psi particle, we realized that many diverse strands of research were converging on a single theory of physics.

<https://www.nobelprize.org/prizes/physics/1979/lashow/biographical/>

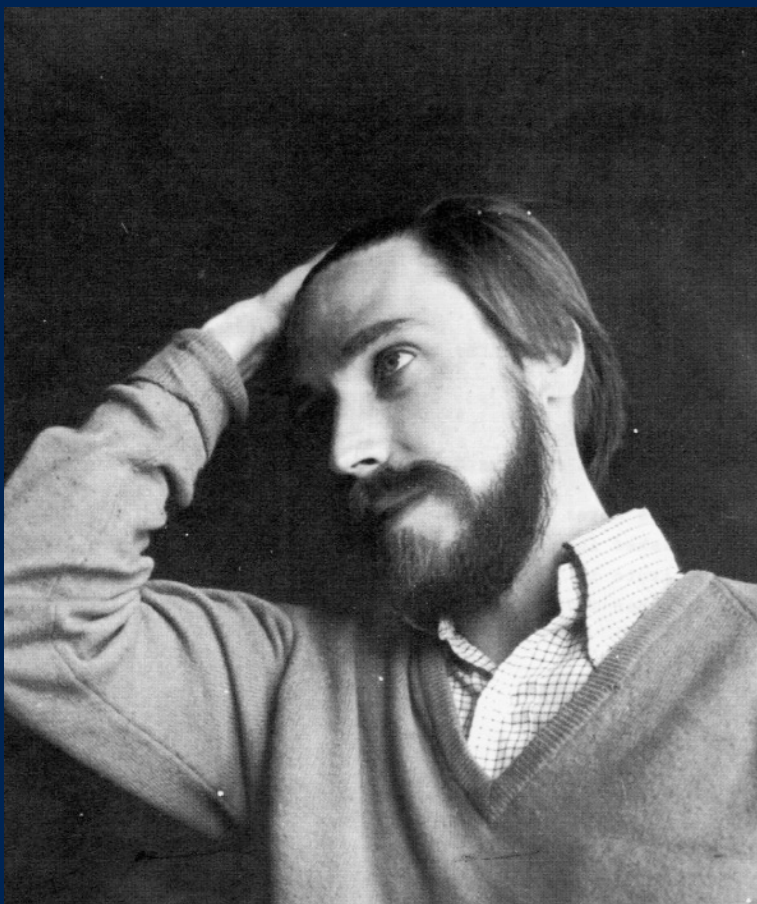

AIP Emilio
Segrè
Visual
Archives



University of
Hawaii High
Energy Physics
Group,
courtesy AIP
Emilio Segrè
Visual Archives

Is Bound Charm Found?*

A. De Rújula

Lyman Laboratory of Physics, Harvard University, Cambridge, Massachusetts 02138

and

S. L. Glashow†

Center for Theoretical Physics, Massachusetts Institute of Technology, Cambridge, Massachusetts 02139

(Received 27 November 1974)

We argue that the newly discovered narrow resonance at 3.1 GeV is a 3S_1 bound state of charmed quarks and we show the consistency of this interpretation with known meson systematics. The crucial test of this notion is the existence of charmed hadrons near 2 GeV.

A surprisingly narrow resonance at $M = 3.1$ GeV was discovered in $p + \text{Be} \rightarrow e^+ + e^- + \dots$ ¹ and in e^+e^- annihilation.² Estimates³ of its decay

variant. It contributes to the singlet mass. We suggest that the remaining term is just the sum of the quark masses plus a common additive con-



The New York Times

Founded in 1851

ADOLPH S. OCHS, *Publisher 1896-1935*
 ARTHUR HAYS SULZBERGER, *Publisher 1935-1961*
 ORVIL E. DRYFOOS, *Publisher 1961-1963*

ARTHUR OCHS SULZBERGER, *Publisher*

A. M. ROSENTHAL, *Executive Editor*

SEYMOUR TOPPING, *Managing Editor*

ARTHUR GELB, *Deputy Managing Editor*

JAMES L. GREENFIELD, *Assistant Managing Editor*

LOUIS SILVERSTEIN, *Assistant Managing Editor*

MAX FRANKEL, *Editorial Page Editor*

JACK ROSENTHAL, *Deputy Editorial Page Editor*

CHARLOTTE CURTIS, *Associate Editor*

TOM WICKER, *Associate Editor*

JOHN D. POMFRET, *Exec. V.P., General Manager*

LANCE R. PRIMIS, *Sr. V.P., Advertising*

J. A. RIGGS JR., *Sr. V.P., Operations*

HOWARD BISHOW, *V.P., Employee Relations*

RUSSELL T. LEWIS, *V.P., Circulation*

JOHN M. O'BRIEN, *V.P., Controller*

ELISE J. ROSS, *V.P., Systems*

Europe 3, U.S. Not Even Z-Zero

A team of 126 scientists at the CERN accelerator in Geneva reports proof of an important new subatomic particle, the Z-zero. The discovery carries two messages. The good news is that it confirms a major theory about the fundamental forces of nature. The bad news is that Europeans have taken the lead in the race to discover the ultimate building blocks of matter.

Spurred by an esthetic faith that nature's laws are at root elegantly simple, physicists have long tried to embrace the four basic forces of nature within a unified framework. A theory that unites two of the forces, electromagnetism and the "weak" nuclear force seen in radioactivity, predicts three new particles known as intermediate vector bosons. Dubbed the W+, the W- and the Z-zero, the bosons would mediate the weak force just as the photon mediates the force of electromagnetism.

Looking for the bosons was to be a prime task of the \$500 million accelerator being constructed at Brookhaven on Long Island. But while the Brookhaven machine fell behind schedule, the Geneva accelerator was cunningly upgraded to the energy range at which bosons might be created.

CERN announced discovery of the two W bosons last January and has now found the Z-zero. With that and the previous discovery of "gluons" at a German machine, European accelerators have established a better record of success than any of the three American laboratories.

American physicists blame lack of Federal support. But some observers, like the President's science adviser, George Keyworth, blame the physicists for routinely spreading funds among the three major American research centers. "Our world leadership in high energy physics has been dissipated," he has said. "In the years American physicists squandered on a pork barrel squabble, the Europeans moved boldly ahead."

Narrow national comparisons have little meaning in physics. Several of the "European" successes were due to American physicists working at European machines. But competition is a useful spur, and American accelerators should be designed to win or not be built at all. The string of European successes underscores the strengths of cautious design, consolidated effort and plans and budgets that allow machines to come in on time.

A panel of American physicists is meeting this week at Woods Hole to decide the fate of the limping Brookhaven accelerator and to plan a new machine for the future. The tougher the competition they can arrange for their European colleagues, the faster will be the advance of knowledge.

The 3-0 loss in the boson race cries out for earnest revenge. The physics team needs to try harder, and coach Keyworth should reward any sensible new strategy with management's full support.

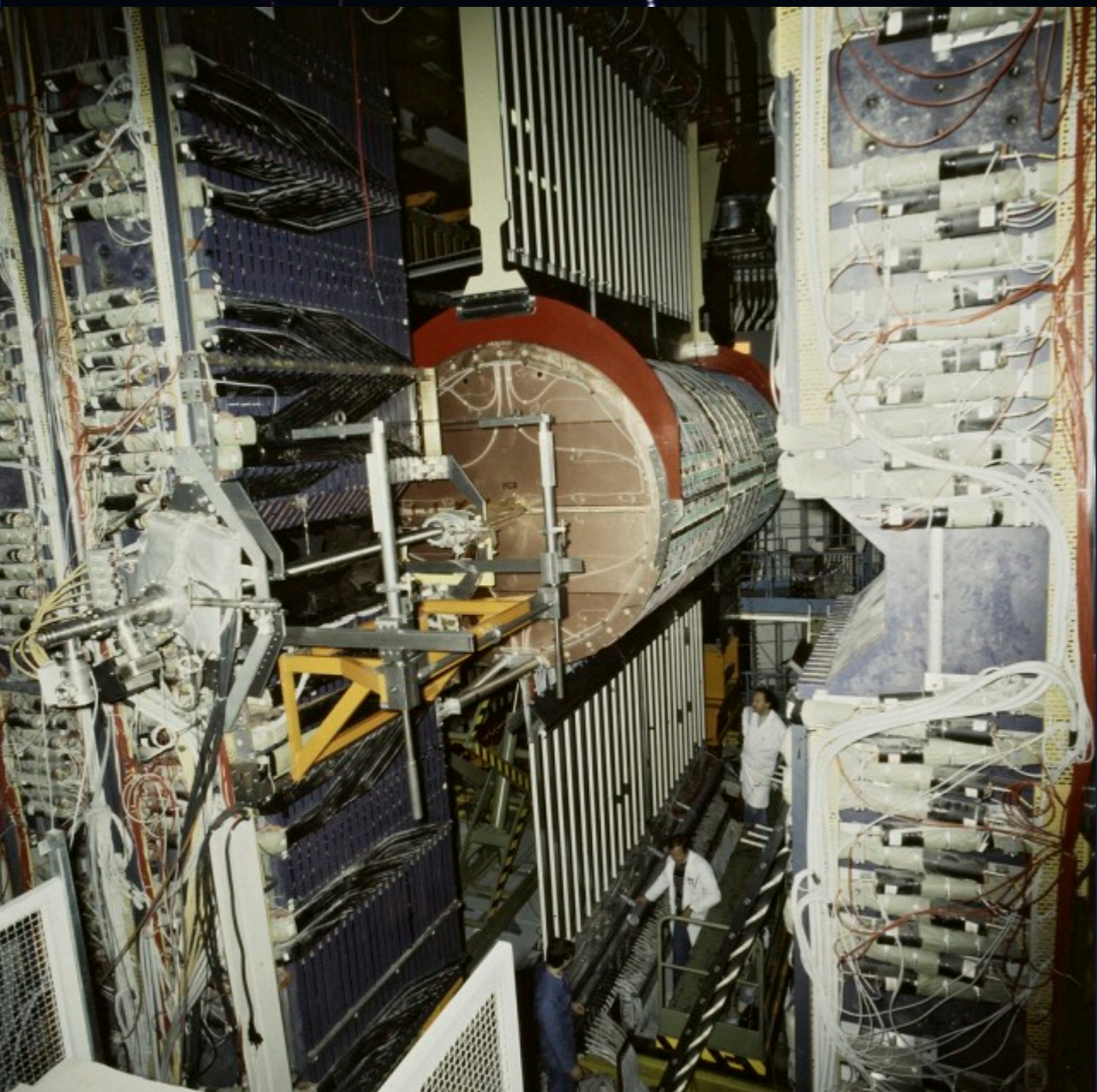
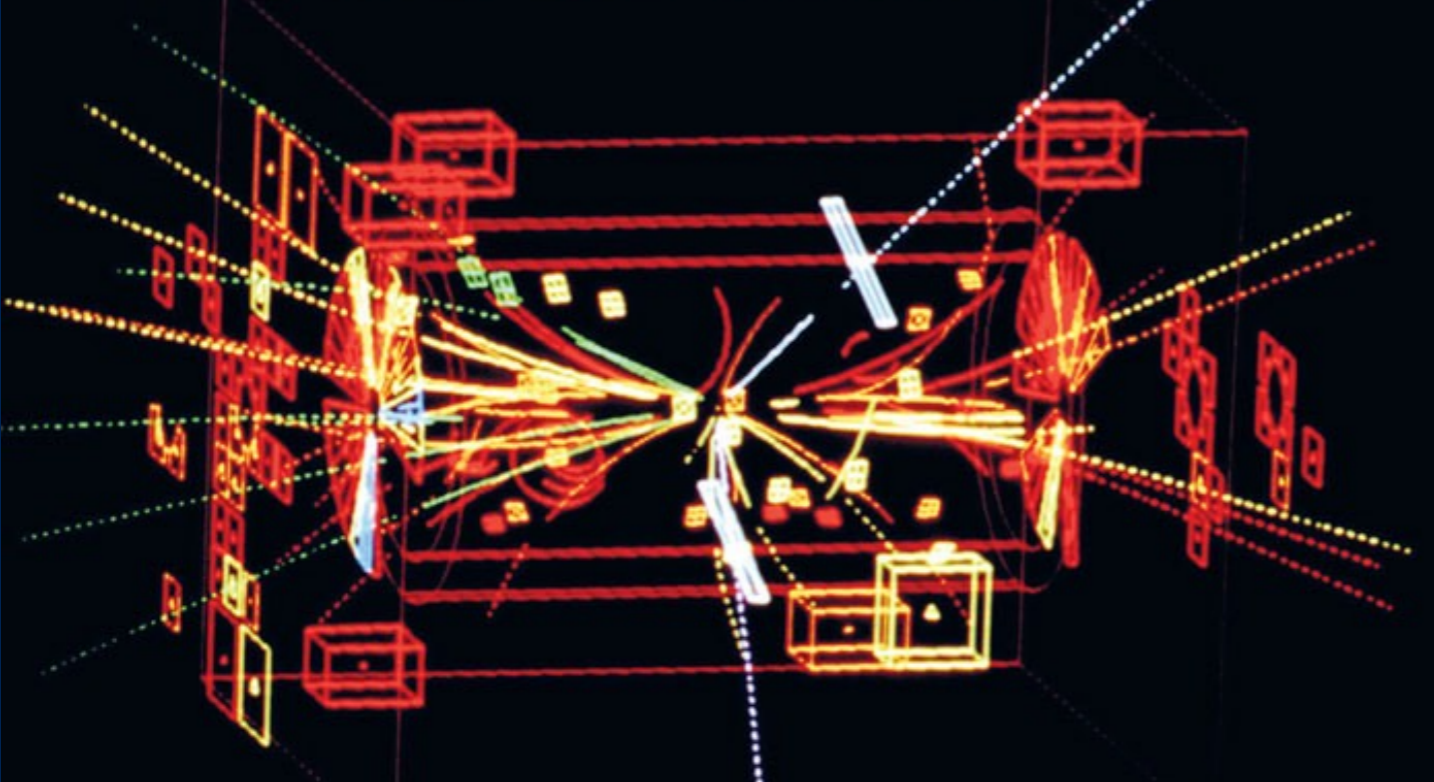

$dN / dm \text{ (events / 4 GeV/c}^2 \text{)}$

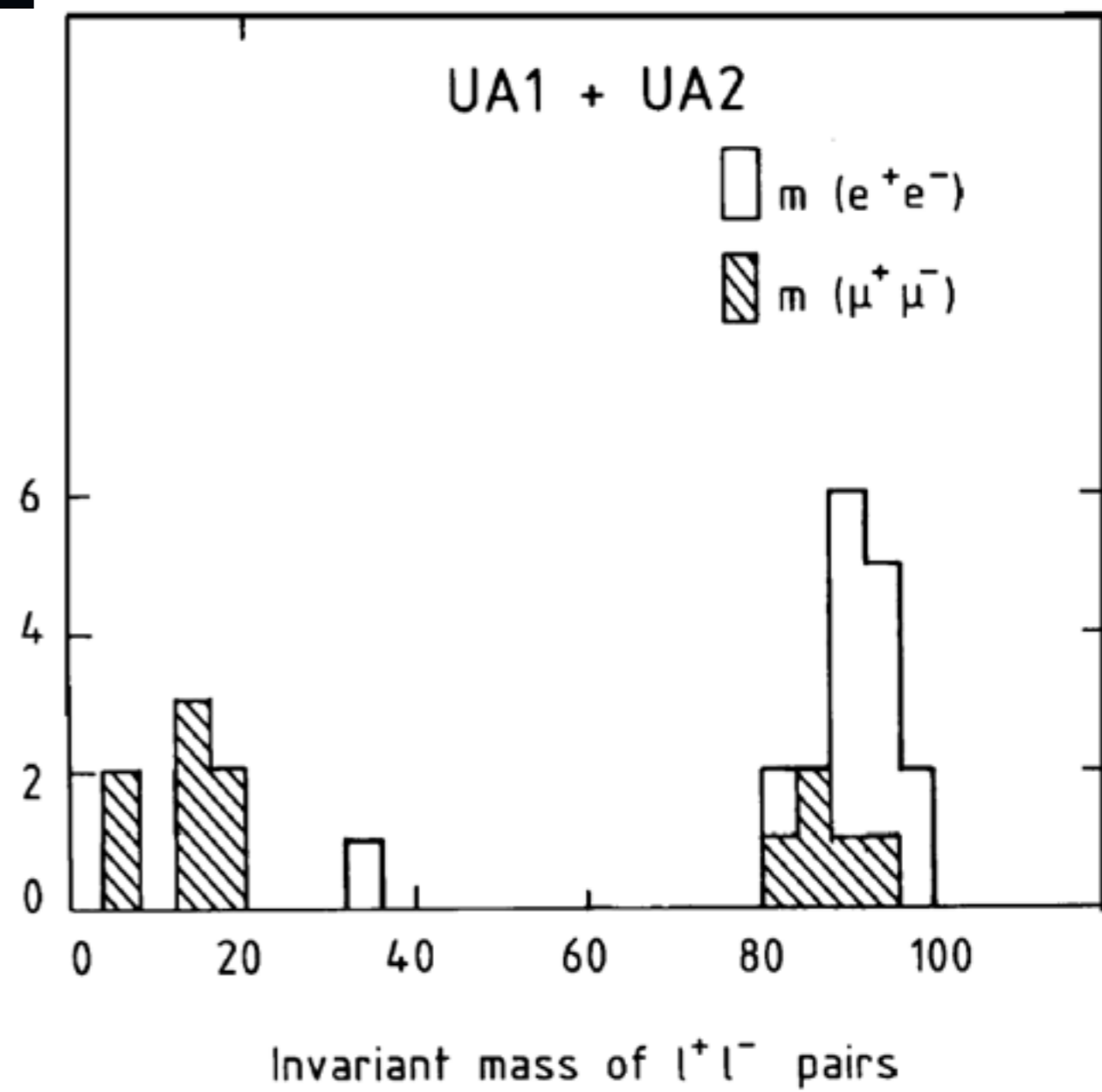

A CMS ZZ* event with both Z's decaying to muons.

This is a "candidate" for Higgs decay at low mass.

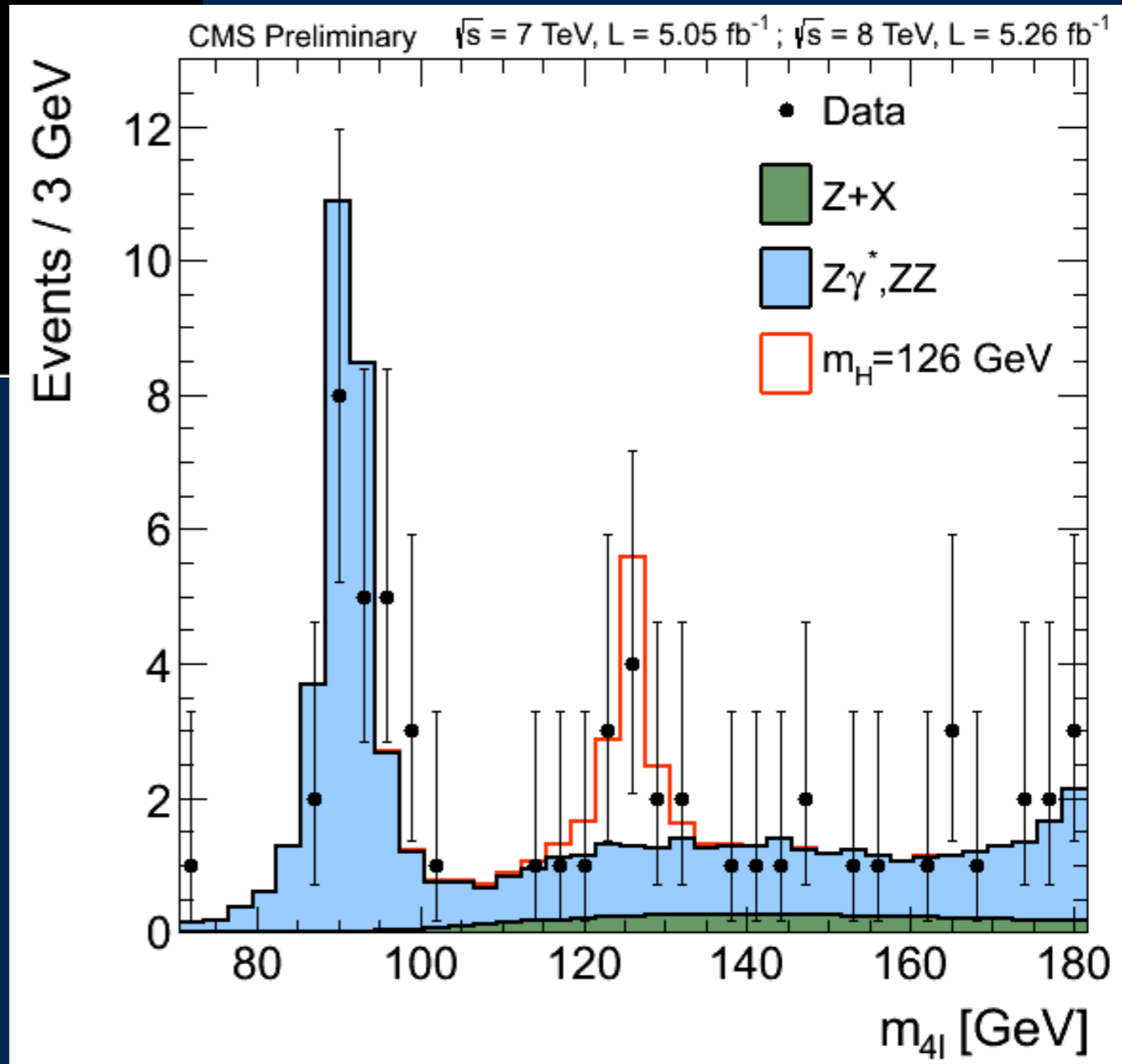
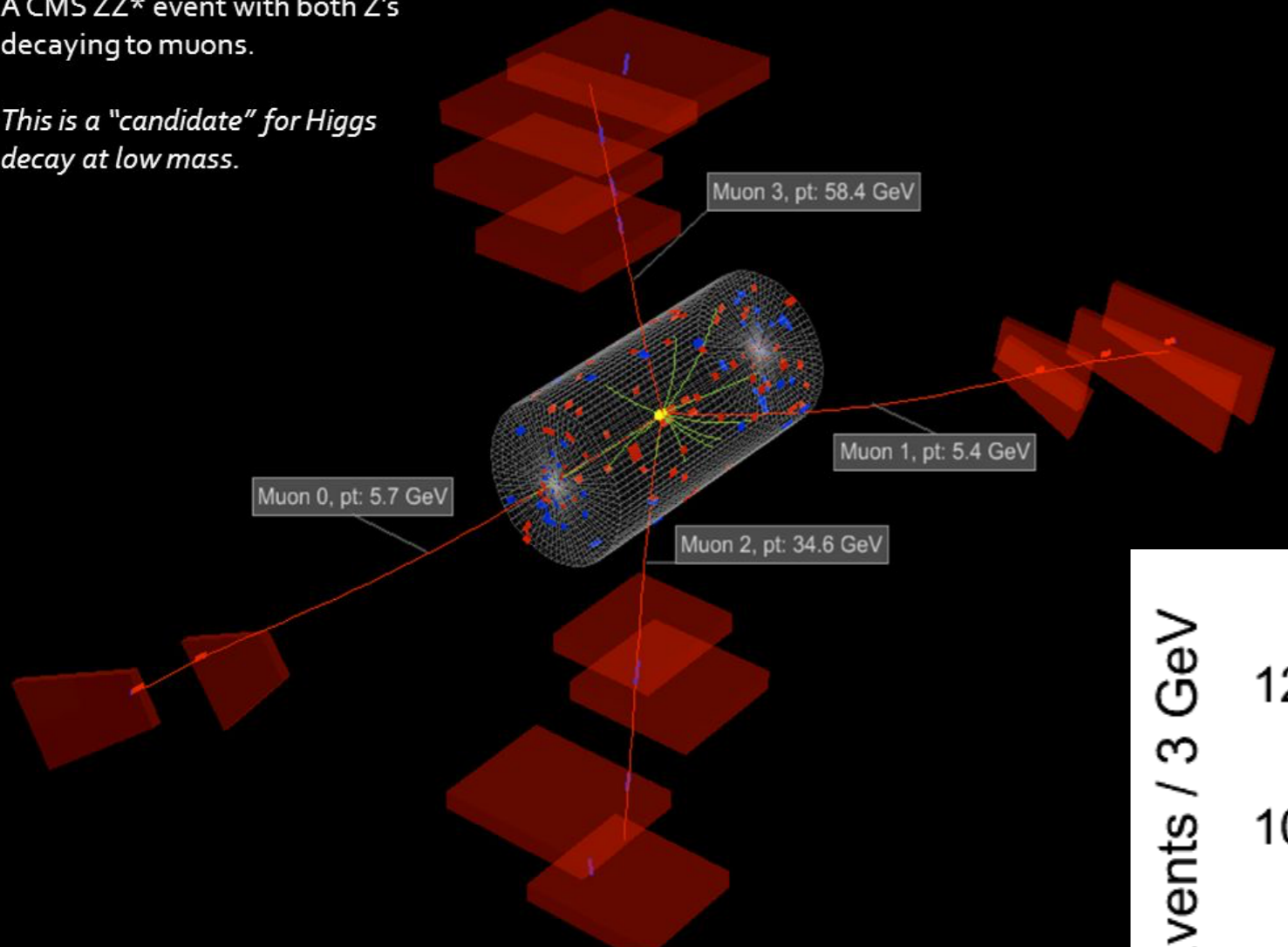

Dónde encontrar material apropiado y cómo usarlo

opendata.cern.ch

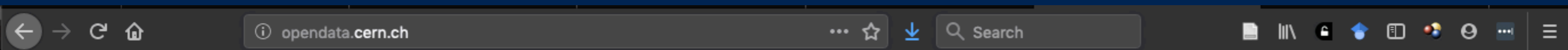

Explore more than **two petabytes**
of open data from particle physics!

 Search

search examples: [collision datasets](#), [keywords:education](#), [energy:7TeV](#)

Explore

- [datasets](#)
- [software](#)
- [environments](#)
- [documentation](#)

Focus on

- [ATLAS](#)
- [ALICE](#)
- [CMS](#)
- [LHCb](#)
- [OPERA](#)
- [Data Science](#)

keyword: education

education x

include on-demand datasets

Filter by type

- Documentation 13
 - Activities 11
 - Help 2

Filter by experiment

- CMS 13

Filter by year

- 2010 5
- 2011 5
- 2012 5

Filter by file type

- docx 1
- gz 3
- pdf 3

Filter by keywords

- datascience 11
- education 13

Sort by: Best match asc. Display: detailed 20 results

Found 13 results.

Instructions for use of CMS Open Data in spreadsheets

CMS Open Data in the form of CSV files can be used in programming applications such as Jupyter notebooks, but they can also be read in and analysed with spreadsheet programs. This can be convenient...

Documentation Activities CMS

Online Analysis of CMS Data with VISPA

With the VISPA internet platform you can perform physics analyses with CMS public data in a web browser. Begin with the discovery of a boson in an example analysis. Then, you can develop your own idea...

Documentation Activities CMS

Physics Masterclasses

Every year, thousands of high-school students all over the world become particle physicists for a day, and visit nearby CMS institutes and universities to perform real analyses using public CMS data. ...

Instructions for use of CMS Open Data in spreadsheets

CMS Collaboration

[Documentation](#) [Activities](#) [Education](#) [Teaching](#) [CMS](#) [CERN-LHC](#)

Description

CMS Open Data in the form of CSV files can be used in programming applications such as Jupyter notebooks, but they can also be read in and analysed with spreadsheet programs. This can be convenient in schools and in the general context of education if teachers and students are already familiar with spreadsheet programs. Note, however, that it can become cumbersome to work with large datasets in these applications. Instructions for use are provided for LibreOffice (in English and Spanish) and for Excel (in English). You can access the repository directly in [this Github repository](#) or download the contents from this record.

Instructions for use of CMS Open Data in R

Villegas Garcia, Edith Natalia;

[Documentation](#) [Activities](#) [Education](#) [Teaching](#) [CMS](#) [CERN-LHC](#)

Description

CMS Open Data in the form of CSV files can be used in programming applications such as Jupyter notebooks or R. A tutorial is provided to introduce R and CMS Open Data. You can access the repository of instructions in different languages in [this Github repository](#) or download the PDF file of the instructions in English from this record. We welcome translations into different languages and other contributions.

Explore CMS open data and visualise detector events - Help

To access the help page for the CMS event display, click on "Need help?" in the top right corner of the page....

[Documentation](#)

[Help](#)

[CMS](#)

<http://opendata.cern.ch/record/5103>

<http://opendata.cern.ch/visualise/events/cms>

Una posibilidad sencilla: usar una muestra *limpia* de *dimuones* para redescubrir la partícula J/ψ o el bosón Z

The events in this derived dataset were selected because of the presence of precisely two muons with invariant mass between 2-110 GeV, one of which is a high-quality "global" muon.

include on-demand datasets

Filter by type

- ▼ Dataset 12
 - Collision 7
 - Derived 5
- ▼ Documentation 1
 - Guide 1
- ▼ Software 6
 - Analysis 3
 - Tool 1
 - Validation 2

Sort by: Best match asc.

Display: detailed 20 results

Found 19 results.

Dimuon events with invariant mass range 2-5 GeV for public education and outreach

The collaboration approved 2000 dimuon events around the J/psi for use in education and outreach. This record contains the necessary files for these use-cases.

These data were selected for u...

Dataset Derived CMS

Dimuon event information derived from the Run2010B public Mu dataset

This document contains 100k dimuon events selected from the Mu dataset from Run2010B. Each line corresponds to an event. The main file contains all 100k events. Files with an underscore contain 10k...

Dataset Derived CMS

Dimuon events for use in outreach and education

The CMS collaboration has approved the release of 100k dimuon events in the invariant mass range 2-110 GeV for use in outreach and education. This document contains the files for this release.

Herramientas necesarias:

1. Entendimiento básico del funcionamiento de un detector
2. Ley de conservación de la energía y el momento (E, \vec{p})
3. Expresión relativista de la energía de una partícula:

$$E^2 = (pc)^2 + (mc^2)^2$$

Aquí están los detalles:

<https://fbarradass.wordpress.com/2011/05/13/%C2%BFcomo-saber-si-se-ha-descubierto-una-particula-1/>

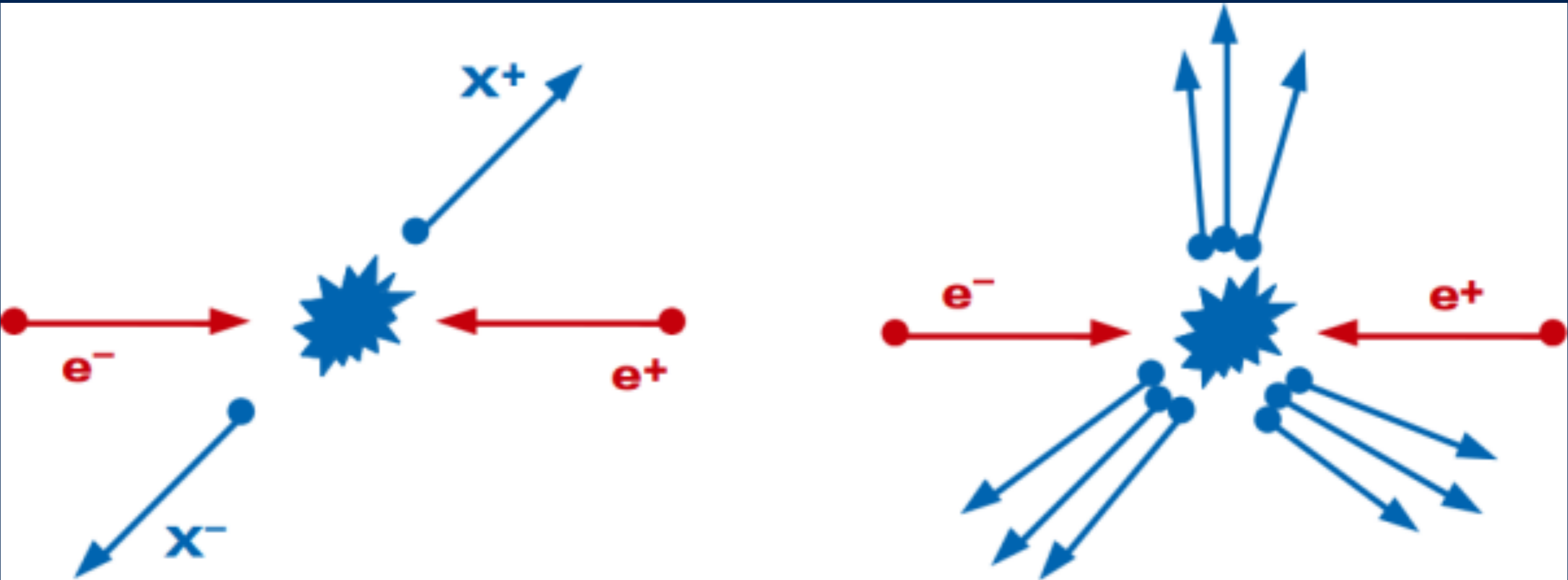

Cuando chocan un electrón y un positrón a altas energías hay muchas posibilidades distintas; en primer lugar podrían “rebotar” sin más (colisión elástica), pero más comúnmente se aniquilan y como resultado **final** aparecen nuevas partículas como

- ◆ parejas partícula / antipartícula (e^+/e^- , μ^+/μ^- ...)
- ◆ hadrones (partículas compuestas por quarks)...



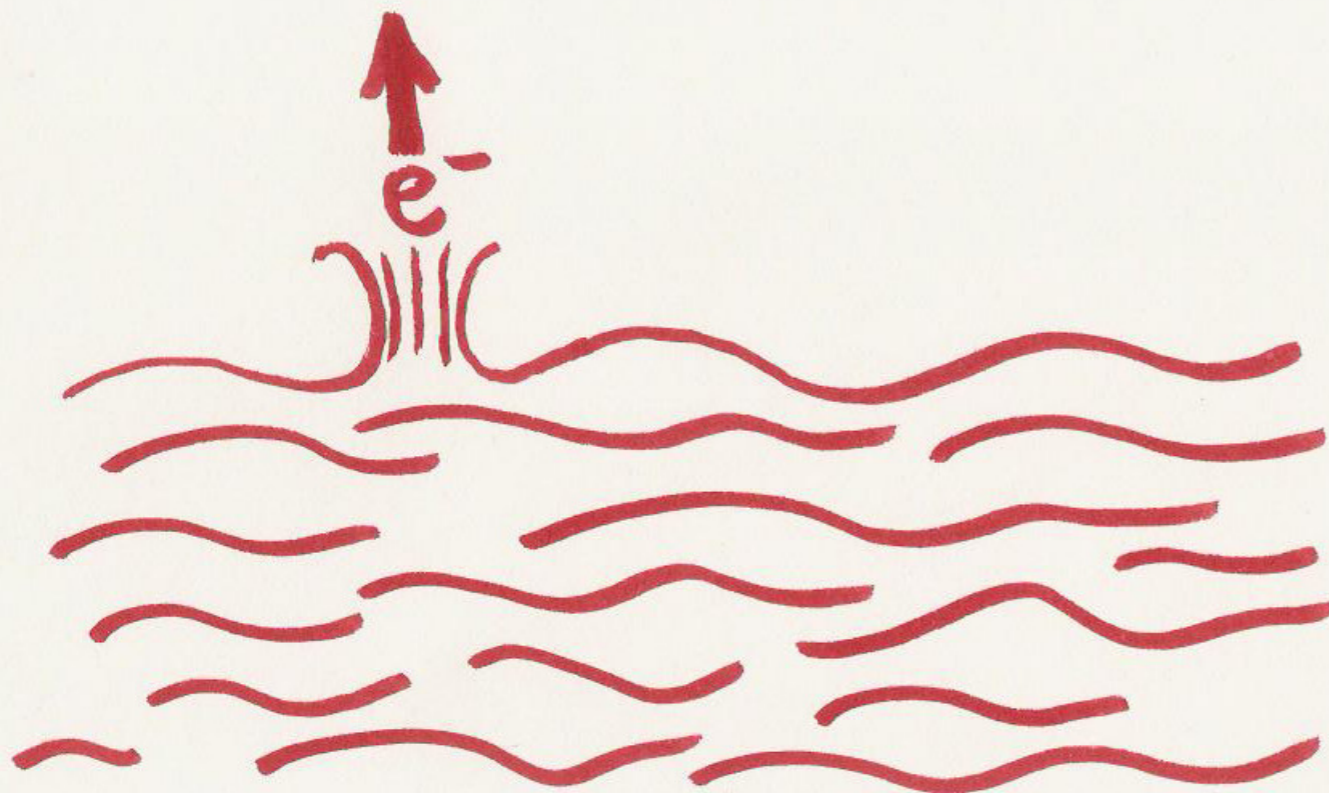

UN ELECTRÓN LIBRE NO ES UNA BOLITA CARGADA, ES MÁS BIEN UNA EXCITACIÓN ESPECIAL DEL

CAMPO ELECTRÓNICO

PARA LA QUE SE CUMPLE

$$E^2 = (pc)^2 + (m_e c^2)^2$$

EN UNA COLISIÓN, POR EJEMPLO

$e^+ e^-$

LA ENERGÍA DE LOS CAMPOS QUE "LLENAN" EL ESPACIO SE PUEDE REDISTRIBUIR DANDO LUGAR A NUEVAS EXCITACIONES TIPO PARTÍCULA, EN ESTE

CASO **DOS MUONES**

$\mu^+ \mu^-$

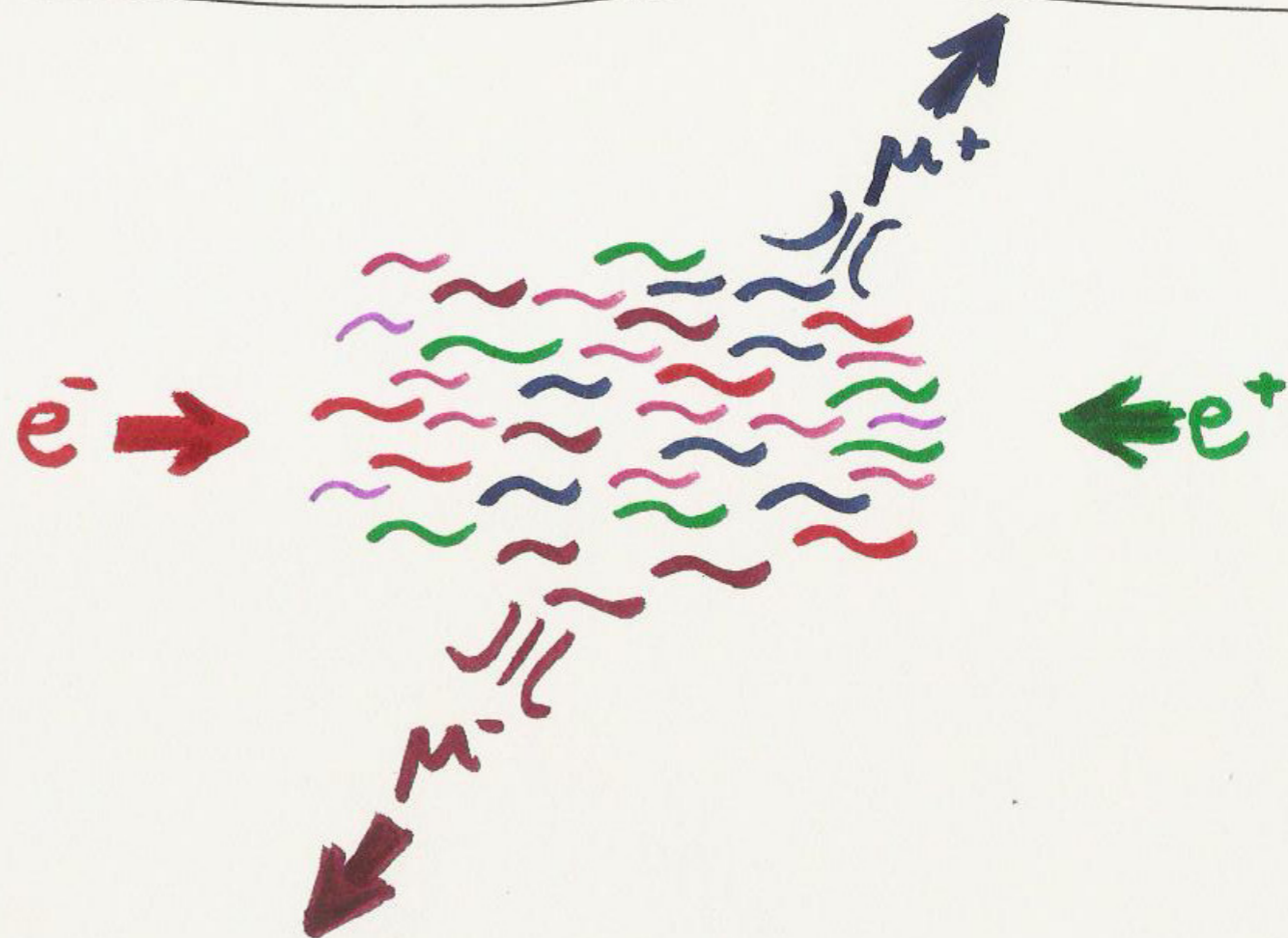

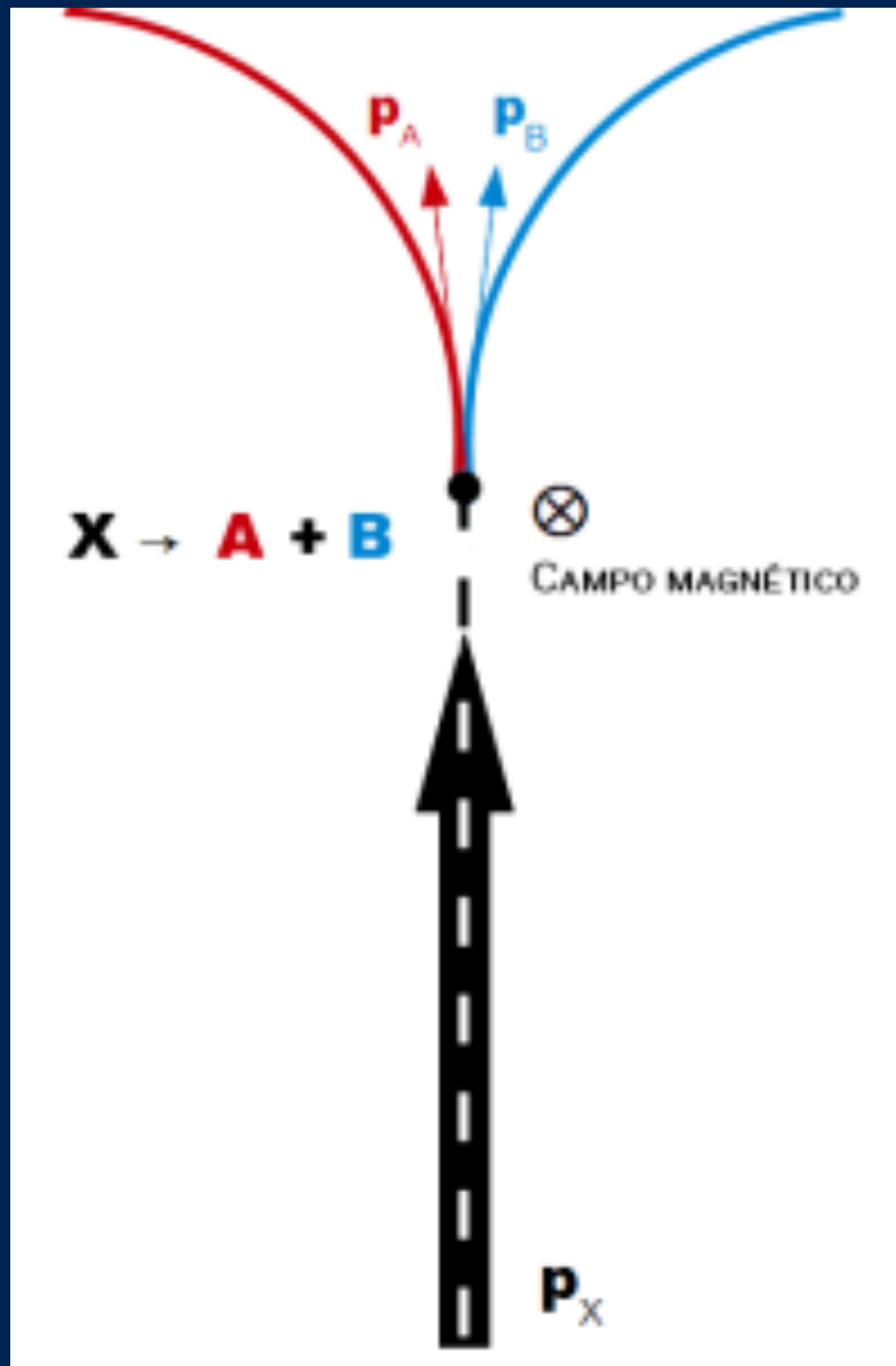

$$X \rightarrow A + B$$

$$\vec{p}_X = \vec{p}_A + \vec{p}_B$$

$$E_X = E_A + E_B$$

$$E = \left(\vec{p}^2 c^2 + m^2 c^4 \right)^{\frac{1}{2}}$$

$$E_X^2 = \vec{p}_X^2 c^2 + M_X^2 c^4$$

$$M_X = \frac{1}{c^2} \left(E_X^2 - \vec{p}_X^2 c^2 \right)^{\frac{1}{2}}$$

$$M_X = \frac{1}{c^2} \left[(E_A + E_B)^2 - c^2 (\vec{p}_A + \vec{p}_B)^2 \right]^{\frac{1}{2}}$$

<http://opendata.cern.ch/search?cc=CMS-Derived-Datasets&ln=en&jrec=51>

Showing records 51 to 59 out of 59 results.

Example CSV output file for SUSYBSMAnalysis-RazorFilter

This file contains events from the Multijet primary dataset from the CMS open data release, and computes the razor variables MR and Rsq, used in supersymmetric particle searches. More details on the razor variables can be found in Phys. Rev

Collection CMS-Derived-Datasets DOI 10.7483/OPENDATA.CMS.GACK.GEJA Author Duarte, Javier

Parent Dataset /Multijet/Run2010B-Apr21ReReco-v1/AOD

Dimuon event information derived from the Run2010B public Mu dataset

This document contains 100k dimuon events selected from the Mu dataset from Run2010B. Each line corresponds to an event. The main file contains all 100k events

Collection CMS-Derived-Datasets Author McCauley, Thomas

DOI 10.7483/OPENDATA.CMS.CB8H.MFFA Parent Dataset /Mu/Run-2010B-Apr21ReReco-v1/AOD

Muons a Dimuon events for use in outreach and education

Preprocess

The CMS collaboration has approved the release of 100k dimuon events in the invariant mass range 2-110 GeV for use in outreach and education. This document contains the files for this release.

Collection CMS-Derived-Datasets Author McCauley, Thomas

DOI 10.7483/OPENDATA.CMS.4M97.3SQ9

<http://opendata.cern.ch/record/303>

Dimuones: parejas de muones (aquí de cargas opuestas) $\mu^+\mu^-$ "de buena calidad"

Dimuon events for use in outreach and education

McCauley, Thomas

Cite as: [McCauley, T. \(2014\). Dimuon events for use in outreach and education. CERN Open Data Portal. DOI: \[10.7483/OPENDATA.CMS.4M97.3SQ9\]\(#\)](#)

Collection **CMS Derived Datasets** Accelerator CERN-LHC Experiment CMS

Description

The CMS collaboration has approved the release of 100k dimuon events in the invariant mass range 2-110 GeV for use in outreach and education. This document contains the files for this release.

Preview

iSpy WebGL

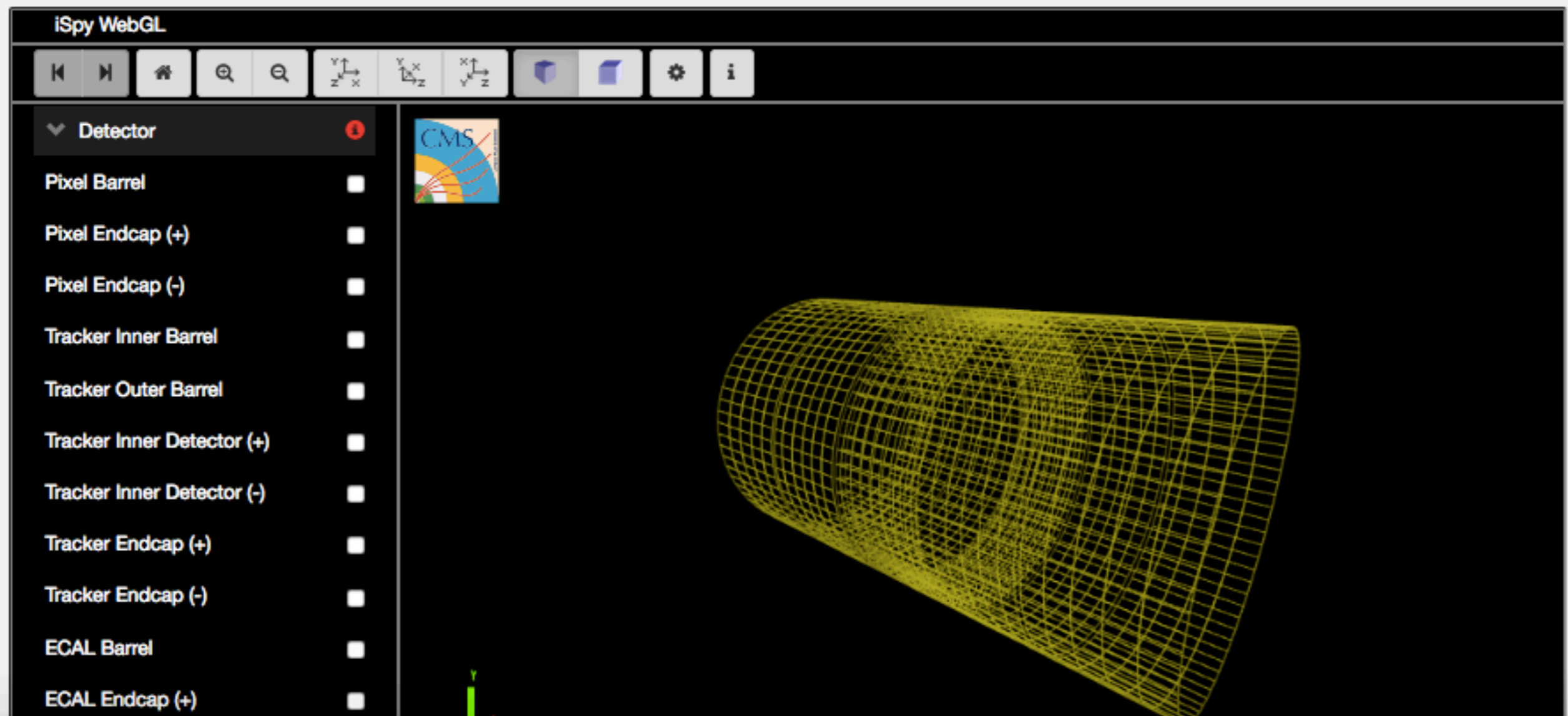

The screenshot shows the iSpy WebGL interface for visualizing the CMS detector. The top toolbar contains icons for navigation (back, forward, home), search, and view controls (orthographic, perspective, isometric, and a cube icon). The left sidebar lists detector components with checkboxes:

- Detector (expanded)
- Pixel Barrel
- Pixel Endcap (+)
- Pixel Endcap (-)
- Tracker Inner Barrel
- Tracker Outer Barrel
- Tracker Inner Detector (+)
- Tracker Inner Detector (-)
- Tracker Endcap (+)
- Tracker Endcap (-)
- ECAL Barrel
- ECAL Endcap (+)

The main 3D view area displays a yellow wireframe model of the CMS detector, showing the cylindrical structure of the tracker and the endcap regions.

| A1 | Type | Run | Event | E1 | px1 | py1 | pz1 | pt1 | eta1 | phi1 | Q1 | E2 | px2 |
|----|------|--------|------------|---------|----------|----------|----------|--------------|---------------|---------------|----|---------|-------|
| 1 | GT | 140124 | 1007912007 | 13.7061 | 4.88649 | -2.5086 | 12.5569 | 5.4928006044 | 1.564708153 | -0.4742899747 | 1 | 3.67389 | -0.68 |
| 2 | GT | 140124 | 1007957044 | 9.09052 | -2.16135 | -2.96392 | -8.31686 | 3.6682769237 | -1.5571370107 | -2.2008651123 | -1 | 3.80945 | 0.787 |
| 3 | GG | 140124 | 1008000431 | 6.81754 | 5.76035 | 3.23987 | -1.67015 | 6.6089628339 | -0.2500945607 | 0.5123463528 | 1 | 19.1486 | 12.8 |
| 4 | GT | 140124 | 1008032300 | 31.8853 | -5.85709 | 2.78331 | -31.2188 | 6.48477585 | -2.2753268595 | 2.6979782463 | 1 | 4.26886 | -1.50 |
| 5 | GT | 140124 | 1008075983 | 13.5527 | 1.18694 | -2.35966 | -13.2924 | 2.641367426 | -2.3187715021 | -1.1047411075 | 1 | 4.36207 | 1.19 |

iSpy WebGL
dimuon-Jpsi_3.ig:Events/Run_140124/Event_1027160502 [10 of 100]

⏪ ⏩ 🏠 🔍 🔍

Y↑ Z→ X← Y← X↑ Z→ X↑ Y← Z→

📦 📦 ⚙️ ℹ️

Detector ⓘ

- Pixel Barrel
- Pixel Endcap (+)
- Pixel Endcap (-)
- Tracker Inner Barrel
- Tracker Outer Barrel
- Tracker Inner Detector (+)
- Tracker Inner Detector (-)
- Tracker Endcap (+)
- Tracker Endcap (-)
- ECAL Barrel
- ECAL Endcap (+)
- ECAL Endcap (-)
- HCAL Barrel

CMS Experiment at the LHC, CERN
 Data recorded: 2010-Jul-14 09:01:35.633975 GMT
 Run / Event / LS: 140124 / 1027160502 / 1158

Click on a name under "Provenance", "Tracking", "ECAL", "HCAL", "Muon", and "Physics" to view contents in table

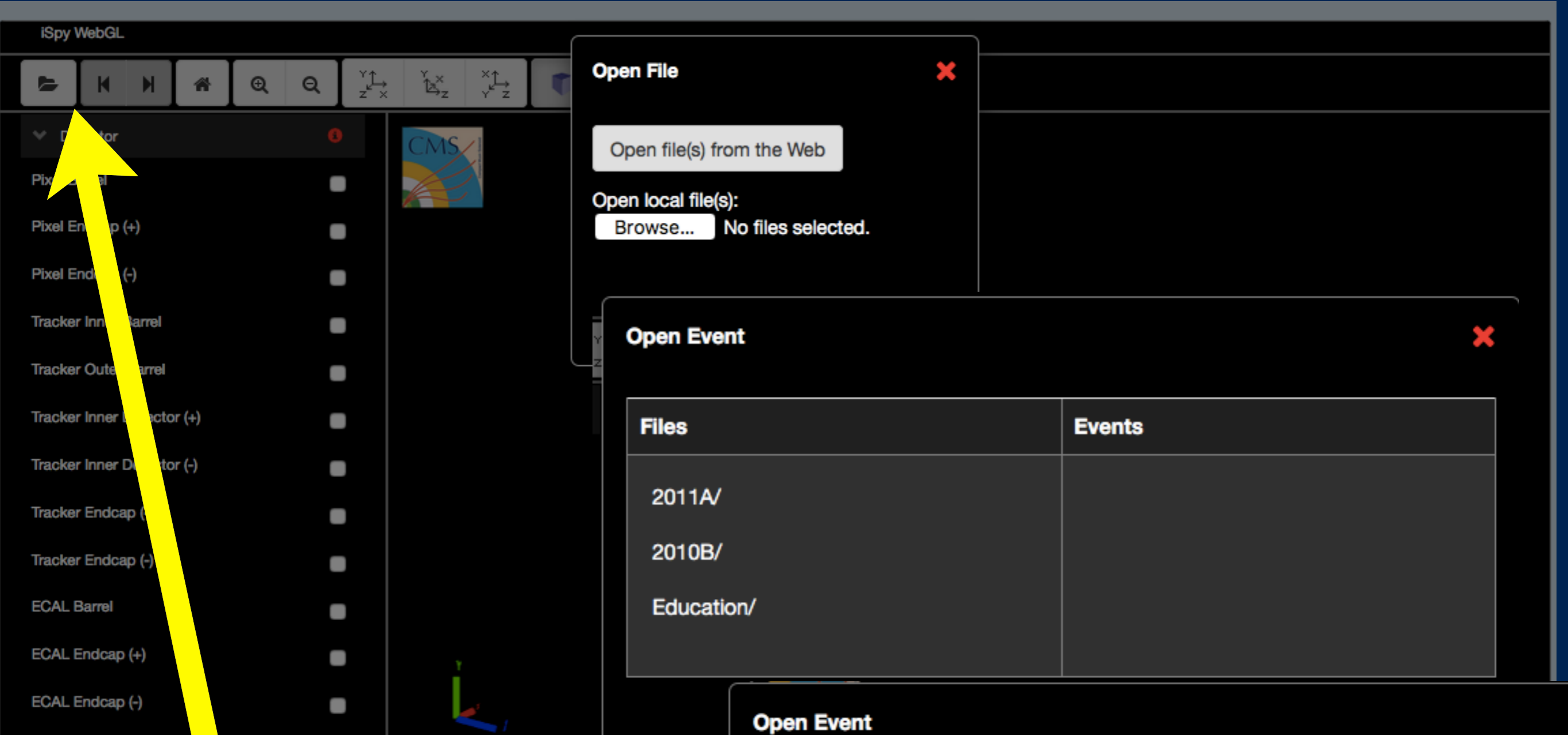

Open File

Open file(s) from the Web

Open local file(s):
Browse... No files selected.

Open Event

| Files | Events |
|------------|--------|
| 2011A/ | |
| 2010B/ | |
| Education/ | |

Open Event

Select

- 4lepton.ig
- diphoton.ig
- dimuon-Jpsi_0.ig
- dielectron-Jpsi_0.ig
- dimuon_0.ig
- dielectron_0.ig
- dielectron-Upsilon_0.ig
- Zee_0.ig

Aquí podemos elegir qué colecciones de eventos visualizar

| | Type | Run | Event | E1 | px1 | py1 | pz1 | pt1 |
|---|------|--------|------------|----------|-------------|------------|-----------|----------|
| 1 | GT | 140124 | 1007912007 | 13.70610 | 4.88649000 | -2.5086000 | 12.556900 | 5.492801 |
| 2 | GT | 140124 | 1007957044 | 9.09052 | -2.16135000 | -2.9639200 | -8.316860 | 3.668277 |
| 3 | GG | 140124 | 1008000431 | 6.81754 | 5.76035000 | 3.2398700 | -1.670150 | 6.608963 |

| | Q1 | E2 | px2 | py2 | pz2 | pt2 |
|----|----------|------------|--------------|----------|------------|-----|
| 1 | 3.67389 | -0.6832500 | 0.529614000 | 3.56917 | 0.8644776 | |
| -1 | 3.80945 | 0.7874280 | -0.775826000 | -3.64400 | 1.1054179 | |
| 1 | 19.14860 | 12.8875000 | 12.388700000 | -6.86217 | 17.8764522 | |

En los archivos .csv con los datos la última columna contiene ya las masas invariantes calculadas, pero puede ser una buena idea que las calculemos nosotros mismos a partir de las energías y momentos.

$$M_X = \frac{1}{c^2} \left[(E_1 + E_2)^2 - c^2 (\vec{p}_1 + \vec{p}_2)^2 \right]^{\frac{1}{2}}$$

Y ahora...

manos a la obra

Herramientas:

Por el momento sólo histogramas de M

- Hoja de cálculo: *Excel* sí, *LibreOffice Calc* no :-_(
- Algo más potente, como **R**

Filter by type

| | |
|---|-----|
| <input checked="" type="checkbox"/> Dataset | 4 |
| <input type="checkbox"/> Derived | 4 |
| Filter by experiment | |
| <input checked="" type="checkbox"/> CMS | 4 |
| <input type="checkbox"/> OPERA | 831 |
| Filter by file type | |
| <input type="checkbox"/> aod | 2 |
| <input type="checkbox"/> aodsim | 17 |
| <input type="checkbox"/> cc | 4 |
| <input checked="" type="checkbox"/> csv | 4 |
| <input type="checkbox"/> gz | 2 |
| <input type="checkbox"/> h5 | 2 |
| <input type="checkbox"/> ig | 3 |
| <input type="checkbox"/> json | 2 |
| <input type="checkbox"/> m4v | 1 |
| <input type="checkbox"/> pdf | 1 |
| <input type="checkbox"/> png | 2 |
| <input type="checkbox"/> py | 20 |
| <input type="checkbox"/> raw | 1 |
| <input type="checkbox"/> root | 24 |
| <input type="checkbox"/> txt | 1 |
| <input type="checkbox"/> xls | 1 |
| <input type="checkbox"/> xml | 3 |
| <input type="checkbox"/> zip | 1 |

Z to ee candidate events for public use

500 Z ee candidate events from real data (2010, 7 TeV) approved for public outreach and education usage at Dec 2010 Collaboration Board meeting.

These data were selected for use in education...

[Dataset](#) [Derived](#) [CMS](#)

Z to mu mu candidate events for public use

500 Z mu mu candidate events from real data (2010, 7 TeV) approved for public outreach and education usage at Dec 2010 Collaboration Board meeting.

These data were selected for use in educat...

[Dataset](#) [Derived](#) [CMS](#)

Datasets derived from the Run2011A SingleElectron, SingleMu, DoubleElectron, and DoubleMu primary datasets

These data were selected from the primary datasets in order to obtain candidate J/psi and Y events, candidate W and Z boson events, and general di-electron and dimuon spectra.

These data wer...

[Dataset](#) [Derived](#) [CMS](#)

Event files for CMS masterclass exercise 2014

This document collects event information for use in the 2014 CMS masterclass exercise. It contains previously-released data: 800 events each of W to munu and enu, 75 events each of Z to ee and mumu...

[Dataset](#) [Derived](#) [CMS](#)

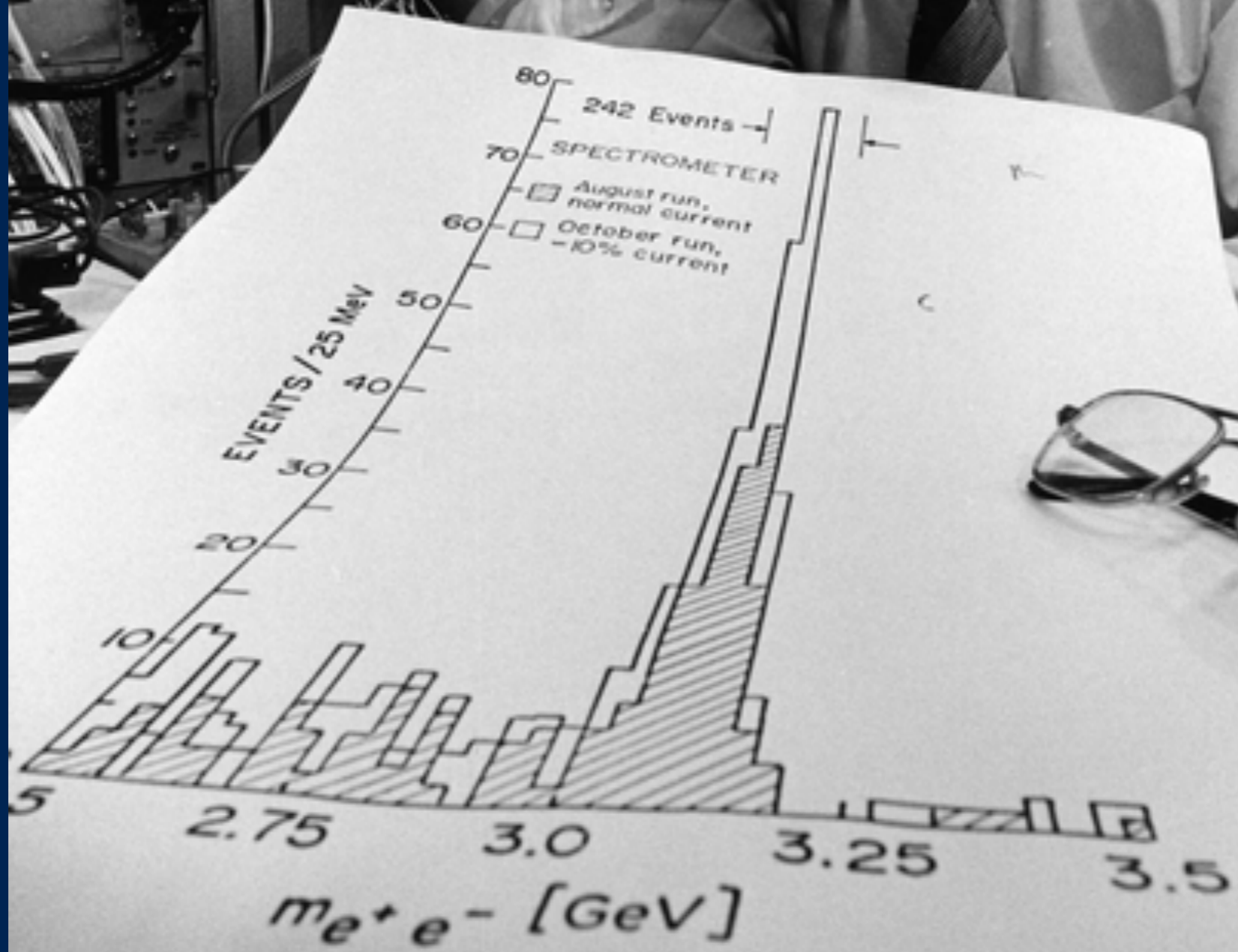
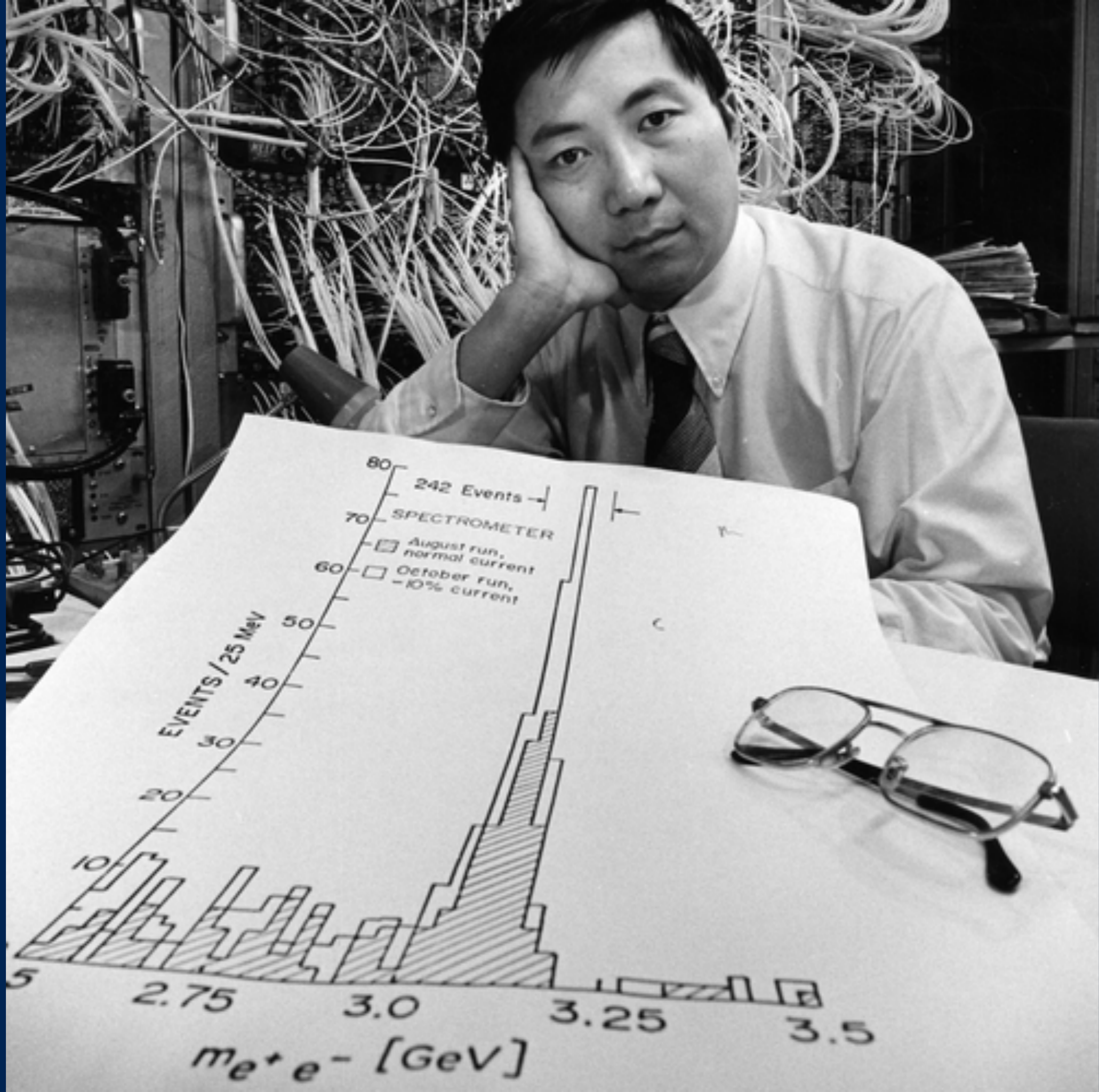

Premio

para el primer equipo que
reproduzca esta foto con
un histograma *hecho por
ellos*