

**Spanish Teacher Program**

*June 30<sup>th</sup>, 2022*

# **Engineering @ CERN**

**(from the point of view of someone who designs and builds superconducting magnets)**

Susana Izquierdo Bermudez

[susana.izquierdo.bermudez@cern.ch](mailto:susana.izquierdo.bermudez@cern.ch)

European Organization for Nuclear Research  
(CERN TE-MS)



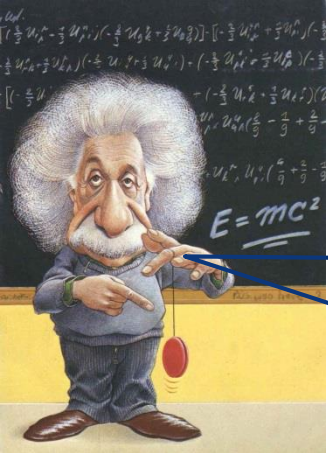

***“We would like to experimentally validate the standard model of particle physics. This model explains how the basic building blocks of matter interact, governed by four fundamental forces. In order to do that, we need to collide particles at a very high energy: 7TeV for each particle, 14 TeV in total.***

***How much this energy is?  
How can we achieve this level of energy?  
What are the main technological challenges we will need to face?***



# Objectives

- Justify the selection of some of the **core technologies** the LHC relies on.
- Provide a **qualitative view** of the **basic elements of the accelerator**.
- Provide a **quantitative view** of some of the many **technological challenges** to overcome in order to build such a complex machine as the LHC.
- Some remarks before we start:
  - **CERN is not only the LHC**, but only in the LHC there are great engineering examples we could be talking for weeks.
  - **The LHC is not only superconducting magnets**, but they are a great piece of engineering with many other associated technologies.

# Contents

- The LHC, its energy and the need to use superconducting materials
- Superconducting magnets
  - Conductor
  - Magnetic design
  - Mechanical design
  - Quench protection
- Cryogenics
- Vacuum
- Interconnections
- Cavities, collimators, detectors, civil engineering, transport.
- Technological challenges for the future machines

# Contents

- The LHC, its energy and the need to use superconducting materials

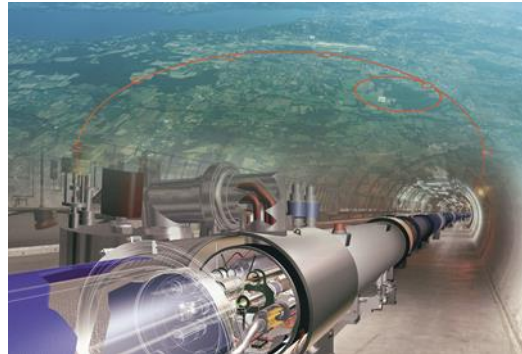

- Superconducting magnets
  - Conductor
  - Magnetic design
  - Mechanical design
  - Quench protection
- Cryogenics
- Vacuum
- Interconnections
- Cavities, collimators, detectors, civil engineering, transport.
- Technological challenges for the future machines

# The LHC

## “The Arc”

- **Dipoles:** magnetic field steers (bends) the particles in a  $\sim$ circular orbit
- **Quadrupoles:** magnetic field provides the force necessary to stabilize linear motion.
  - They act as a spring: **focus the beam**
  - Prevent protons from **falling** to the bottom of the aperture due to the **gravitational force** (it would happen in less than 60 ms!)
- **Correctors**

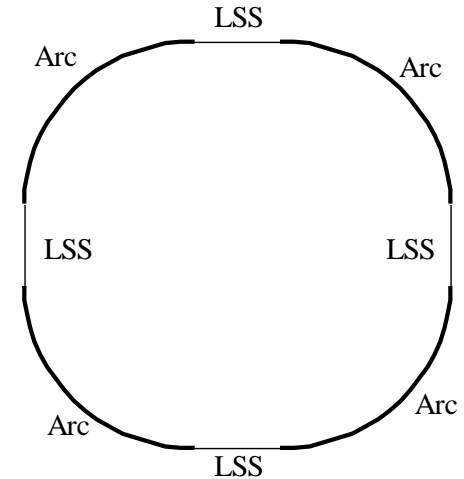

## “Long straight sections (LSS)”

- **Interaction regions (IR)** where the experiments are housed
  - Quadrupoles for strong focusing in interaction point
  - Dipoles for beam crossing in two-ring machines
- **Regions for other services**
  - Beam injection (dipole kickers)
  - Accelerating structure (RF cavities)
  - Beam dump (dipole kickers)
  - Beam cleaning (collimators)

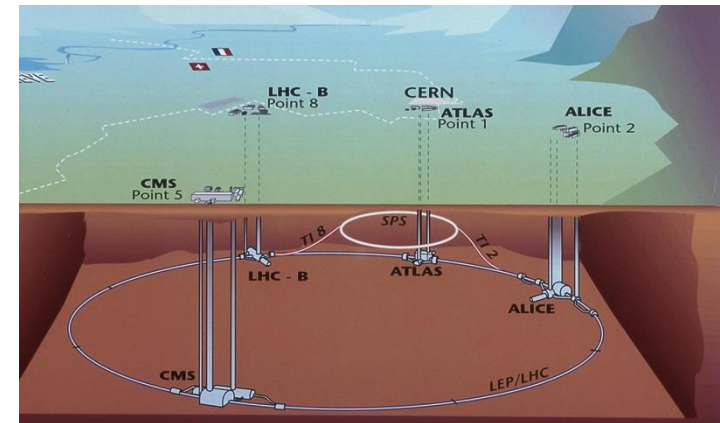

# Energy level in the LHC

**Energy:** Ability of making a work. Typically we measure it in Joules or Calories. In the LHC, in Tera-Electron-Volts (13 TeV). How much is that?

- A Tera is One Million of Millions
- An Electron-Volt is the energy acquired by one electron (or proton) accelerated by a potential of 1 volt.

The **energy of each proton** is: :

$$7\text{TeV} = 7 \cdot 10^{12} \text{eV} = 7 \cdot 10^{12} \cdot 1.6 \cdot 10^{-19} \text{C} \cdot 1\text{V} = \mathbf{1.1 \cdot 10^{-6} \text{J}}$$

In the beam, we have about 310.000 billions of protons (which can seem a lot, but they are  $5 \cdot 10^{-10} \text{g}$ ), so the **energy of the beam** is:

$$310 \cdot 10^{12} \cdot 1.1 \cdot 10^{-6} \text{J} = \mathbf{340 \text{ MJ}} \text{ (340.000 kJ)}$$

If we compare it with a Bic Mac:



A Bic Mac is 500 kcal = 2MJ, and its weight is around 200 grams

The beam energy in the LHC is 340 MJ concentrated in a mass of  $5 \cdot 10^{-10}$  grams.

Thus, the LHC beam has the energy of 170 Bic Mac, concentrated in a mass **400.000.000.000 (400 billions) smaller.**

# Do we need superconductors?

## Principle of synchrotrons:

Driving particles in the same accelerating structure several times.

- **Electro-magnetic field** accelerates particles



$$\vec{F} = e\vec{E}$$

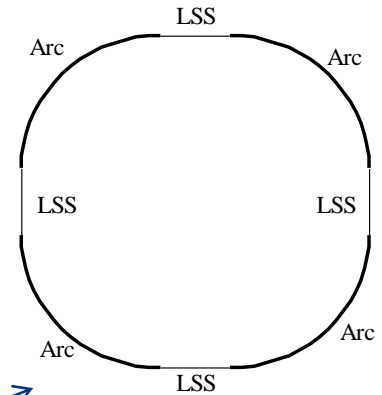

- **Magnetic field steers** the particles in a  $\sim$  circular orbit

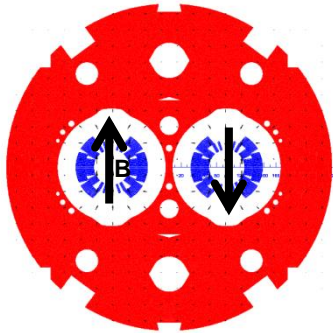

$$\vec{F} = e\vec{v} \times \vec{B}$$



- Particle accelerated  $\rightarrow$  energy increased  $\rightarrow$  magnetic field increased (“**synchro**”) to keep the particles on the same orbit of curvature  $\rho$

$$\uparrow p = eB\rho$$

Constan

**Lesson 1:** If we want more energetic particles, either we make stronger magnets or we increase the size of our accelerator.



# Do we need superconductors?

The magnetic field produced by an electromagnets is proportional to the current density and the size of the coil .

$$B_y = -\frac{\mu_0 J_0}{2} w$$

$J_0$  = current density  
 $w$  = coil width

In normal conducting magnets,  $J \sim 5 \text{ A/mm}^2$

In superconducting magnets,  $J_e \sim 600\text{-}700 \text{ A/mm}^2$

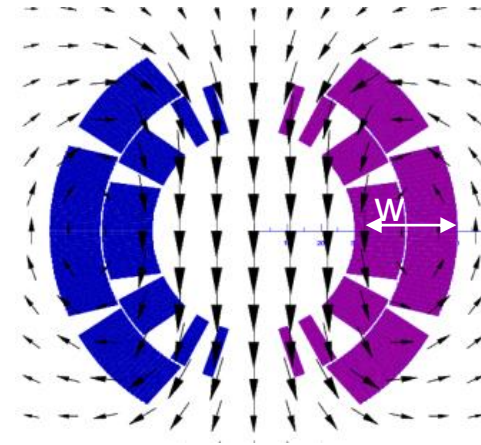

**Lesson 2:** If we want magnets with  $B > 2\text{T}$  and a reasonable size (and energy consumptions), superconductors are needed

So the answer to the question if we need superconductors is:

**¡YES!**

# Do we need superconductors?

**Lesson 1:** If we want more energetic particles, either we make stronger magnets or we increase the size of our accelerator.

**Lesson 2:** If we want magnets with  $B > 2\text{T}$  and a reasonable size (and energy consumptions), superconductors are needed

So the answer to the question if we need superconductors is:

¡YES!

# Contents

- The LHC, its energy and the need to use superconducting materials
- Superconducting magnets
  - Conductor
  - Magnetic design
  - Mechanical design
  - Quench protection

Superconducting strand

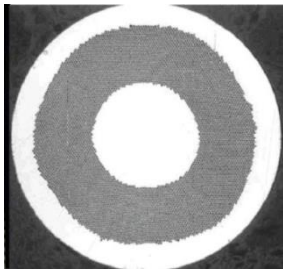

Superconducting cable



Superconducting coil



Superconducting magnet

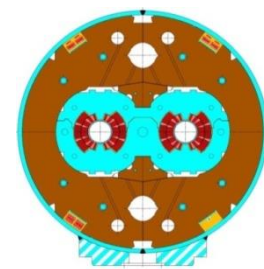

- Cryogenics
- Vacuum
- Interconnections
- Cavities, collimators, detectors, civil engineering, transport.
- Technological challenges for the future machines

# Superconducting magnets

- The science of superconducting magnets is an exciting, fancy and dirty mixture of **physics, engineering, and chemistry**
  - Chemistry and material science: **superconducting materials**
  - Quantum physics: the key mechanisms of **superconductivity**
  - Classical electrodynamics: **magnet design**
  - Mechanical engineering: **support structures**
  - Electrical engineering: **powering** of the magnets and their **protection**
  - Cryogenics: keep them **cool** ...
- Very different order of magnitudes

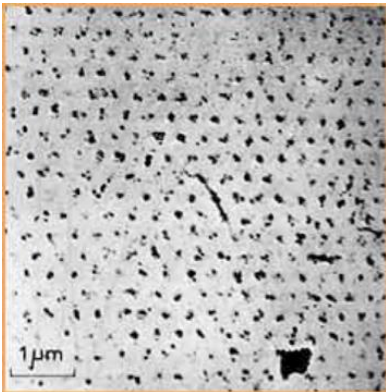

Quantized fluxoids penetrating a superconductor used in accelerator magnets



A 15m truck unloading a 27 tons LHC dipole



Large Hadron Collider  
27 km, 8.33 T, 14 TeV  
1300 tons NbTi

- The **cost** optimization also plays a relevant role

# Superconductivity

In 1911, Kammerling-Onnes, discovered superconductivity (**ZERO resistance** of mercury wire at 4.2 K)

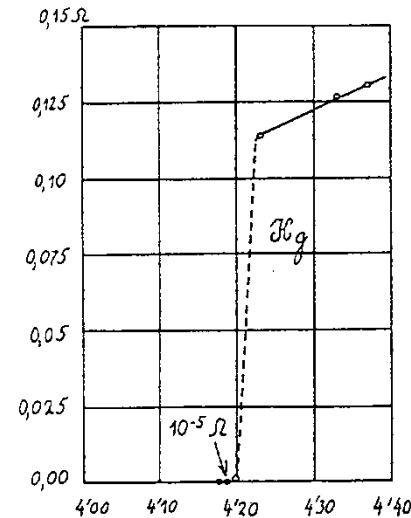
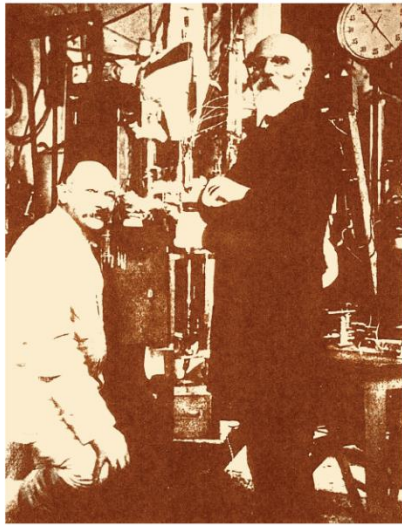

- The temperature at which the transition takes place is called **critical temperature  $T_c$**
- Observed in many materials
  - but not in the typical best conductors (Cu, Ag, Au)
- At  $T > T_c$ , superconductor very poor conductor

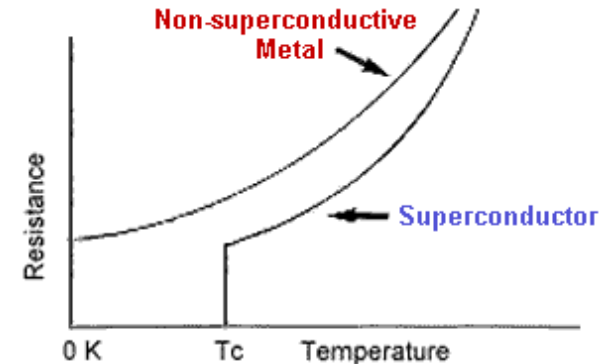

# Practical superconductors

## 50 years later ...

### Nb and Ti → ductile alloy

*Extrusion + drawing*

- $T_c$  is ~**9.2 K** at 0 T
- $B_{c2}$  is ~**14.5 T** at 0 K
- Firstly in **Tevatron** (80s), then all the other
- ~50-200 US\$ per kg of wire  
(1 euro per m)

### Nb and Sn → intermetallic compound

*Brittle, strain sensitive, formed at ~650-700°C*

- $T_c$  is ~**18 K** at 0 T
- $B_{c2}$  is ~**28 T** at 0 K
- Used in **NMR, ITER**
- ~700-1500 US\$ per kg of wire  
(5 euro per m)

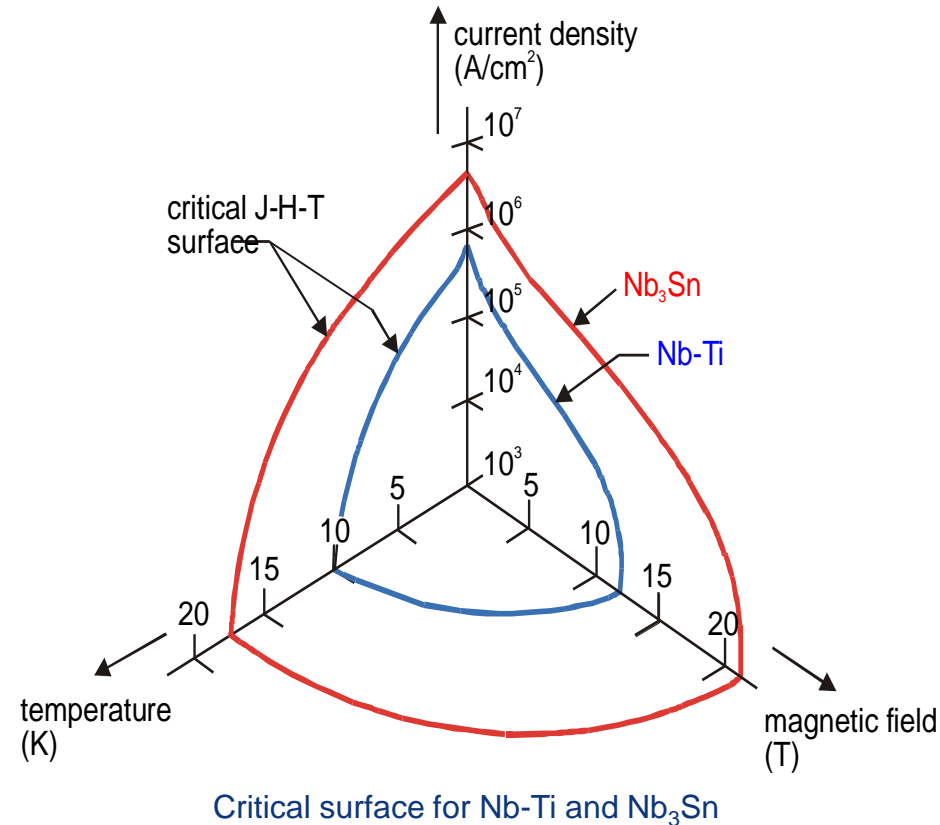

# Practical superconductors

Typical operation parameters  
(for a 0.85 mm diameter strand)

Cu

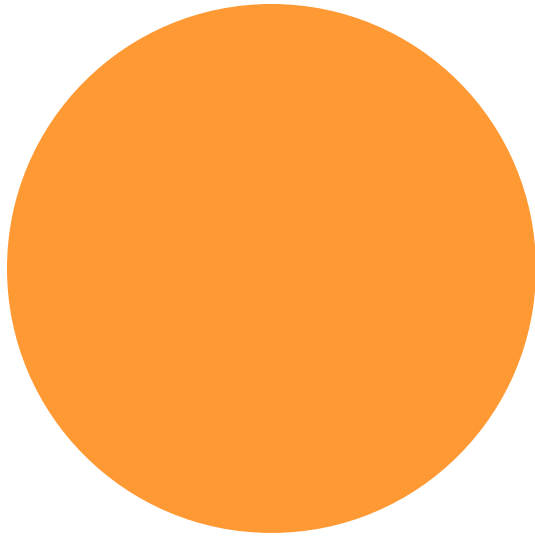

$$J_e \sim 5 \text{ A/mm}^2$$

$$I \sim 3 \text{ A}$$

$$B = 2 \text{ T}$$

Nb-Ti

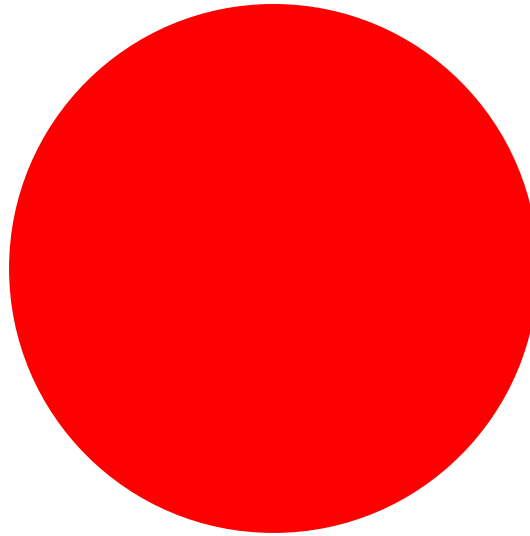

$$J_e \sim 600\text{-}700 \text{ A/mm}^2$$

$$I \sim 300\text{-}400 \text{ A}$$

$$B = 8\text{-}9 \text{ T}$$

Nb<sub>3</sub>Sn

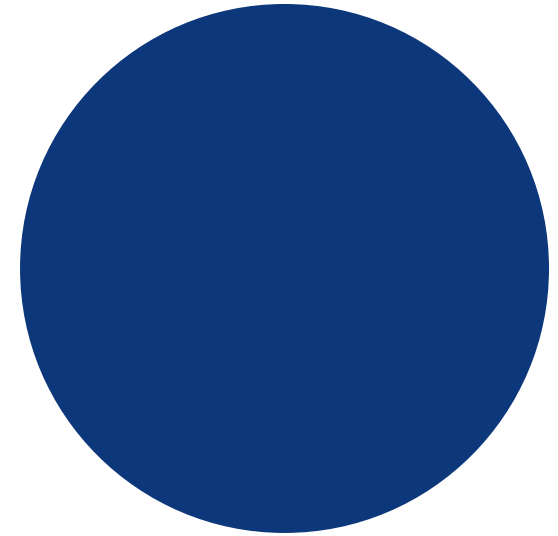

$$J_e \sim 600\text{-}700 \text{ A/mm}^2$$

$$I \sim 300\text{-}400 \text{ A}$$

$$B = 12\text{-}13 \text{ T}$$

# Practical superconductors

Typical operation parameters  
(for a 0.85 mm diameter strand)

By P. Ferracin

Cu

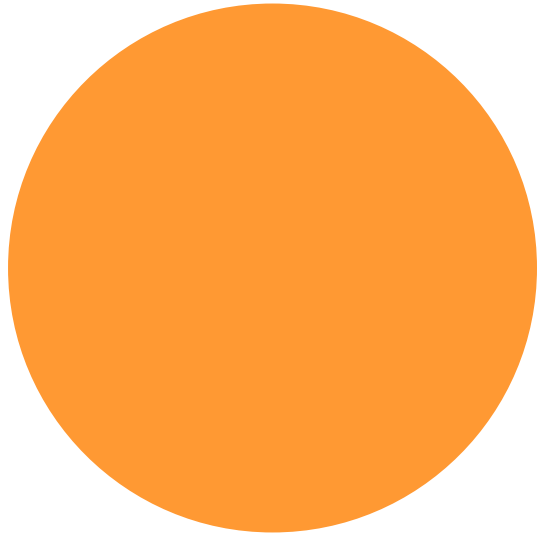

$$J_e \sim 5 \text{ A/mm}^2$$

$$I \sim 3 \text{ A}$$

$$B = 2 \text{ T}$$

Nb-Ti

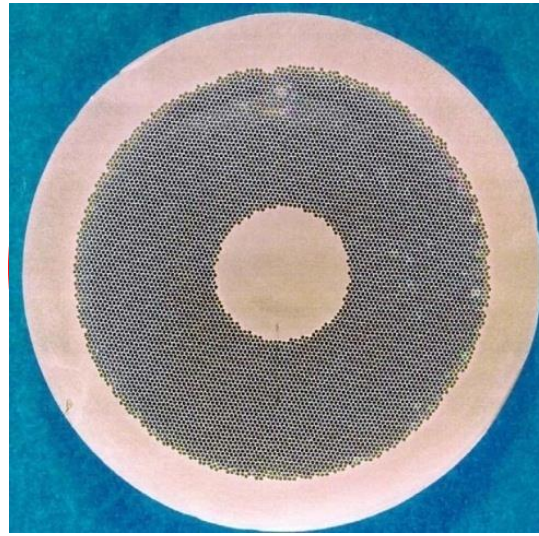

$$J_e \sim 600\text{-}700 \text{ A/mm}^2$$

$$I \sim 300\text{-}400 \text{ A}$$

$$B = 8\text{-}9 \text{ T}$$

Nb<sub>3</sub>Sn

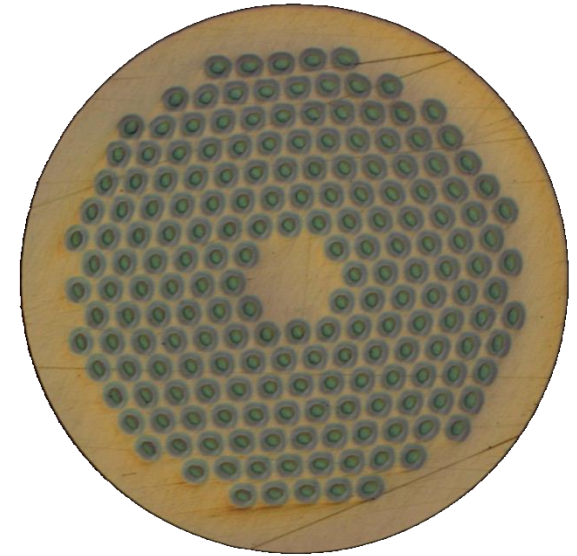

$$J_e \sim 600\text{-}700 \text{ A/mm}^2$$

$$I \sim 300\text{-}400 \text{ A}$$

$$B = 12\text{-}13 \text{ T}$$



# Strand: multifilament wire

Superconducting materials are produced in small filaments and surrounded by a stabilizer (typically copper) to form a “*multi-filament wire*” or “*strand*”

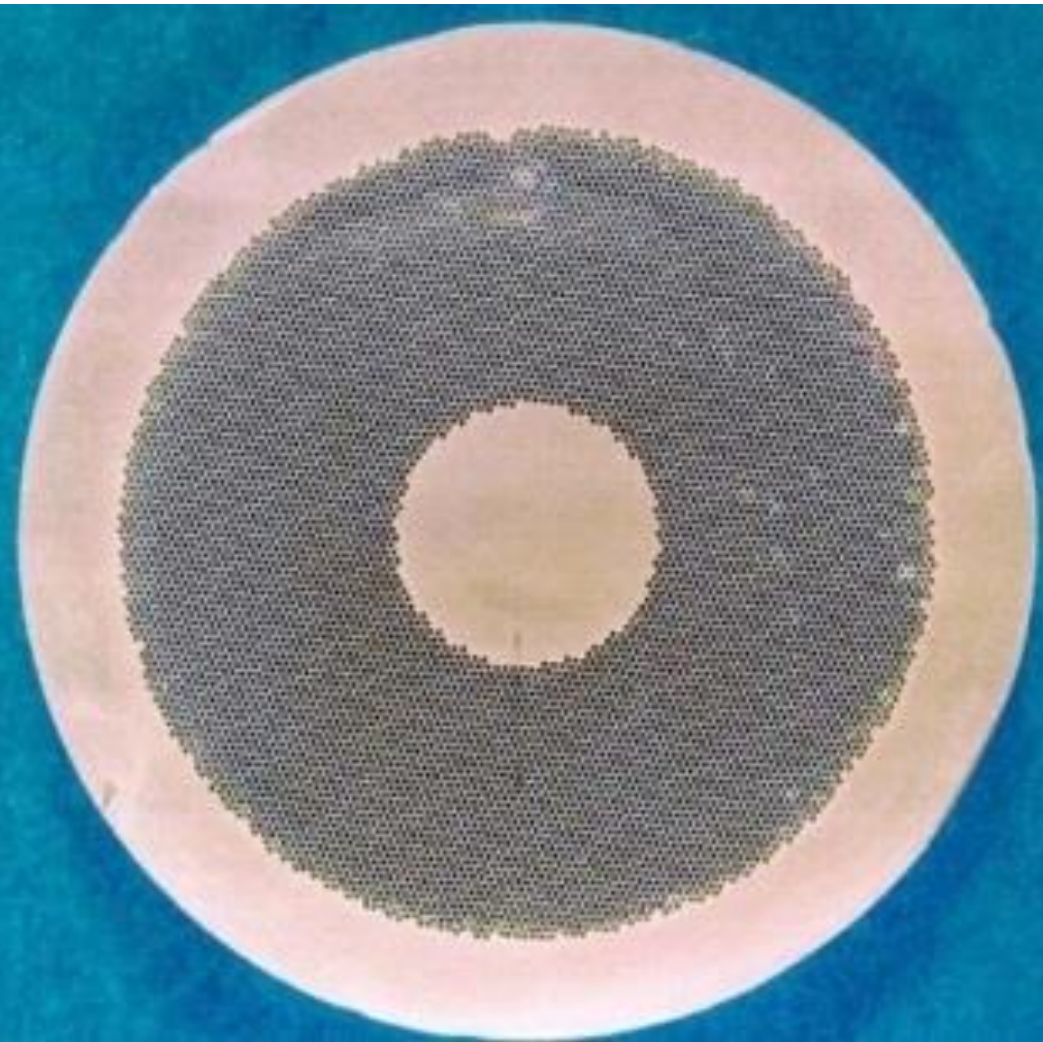

## We small filaments are needed?

- **Stability** (flux jumps)
- **Magnetic field quality**
  - Persistent currents
  - Inter-filament coupling currents

## Why they are embedded in a copper matrix?

- **Protection**, to redistribute the current in case of quench

# Strand: Manufacturing process (NbTi)

- **Nb-Ti ingots**
  - 200 mm  $\phi$ , 750 mm long
- **Monofilament rods** are stacked to form a multifilament billet
  - then extruded and drawn down
  - can be re-stacked: double-stacking process

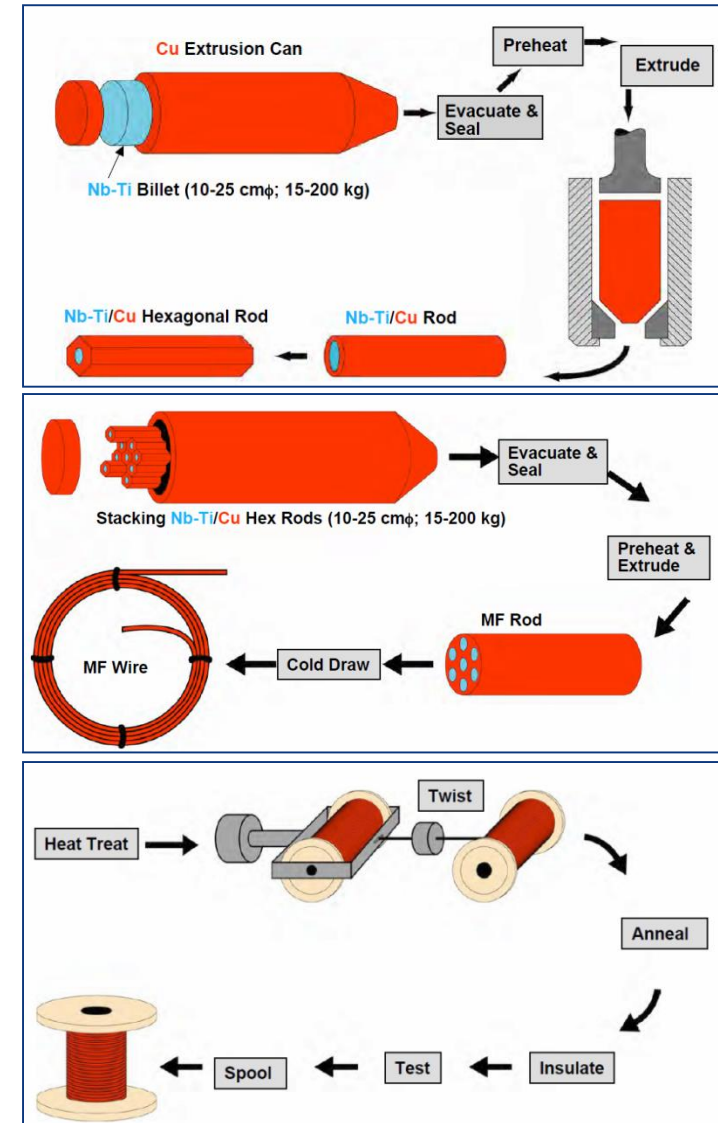
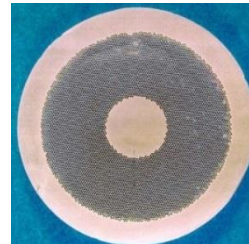
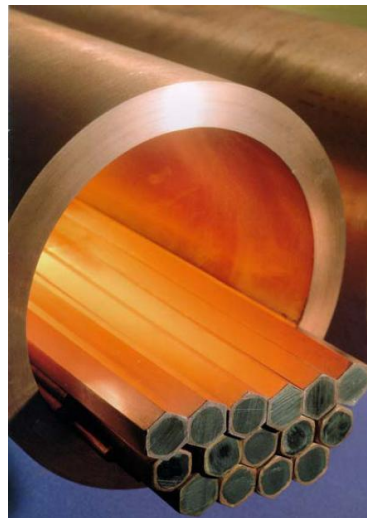

# Strand: Manufacturing process ( $\text{Nb}_3\text{Sn}$ )

- Since  $\text{Nb}_3\text{Sn}$  is brittle
  - it cannot be extruded and drawn like Nb-Ti.
- Process in several steps
  - Assembly multifilament billets from with **Nb and Sn separated**
  - Fabrication of the wire through extrusion-drawing
    - Fabrication of the cable
    - Fabrication of the coil

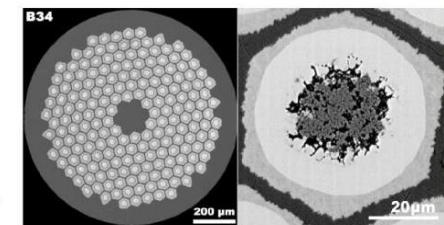
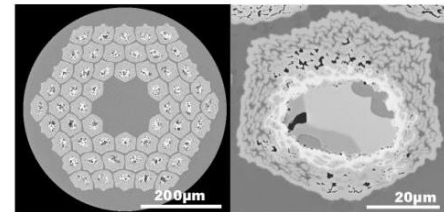
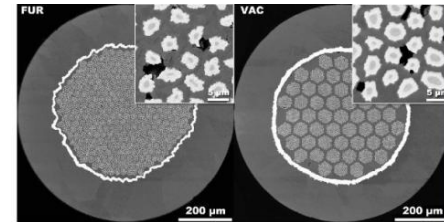
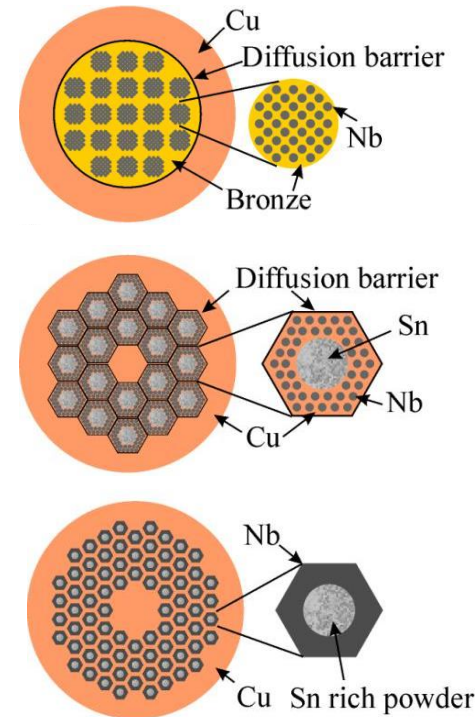

by A. Godeke

## “Reaction”

- Sn and Nb are heated to 600-700 C
- Sn diffuses in Nb and reacts to form  $\text{Nb}_3\text{Sn}$

# The cable

- Most of the superconducting coils for particle accelerators wound from a multi-strand cable (**Rutherford cable**)
- The strands are **twisted** to
  - Reduce **inter-strand coupling currents**
    - Losses and field distortions.
  - Provide more **mechanical stability**

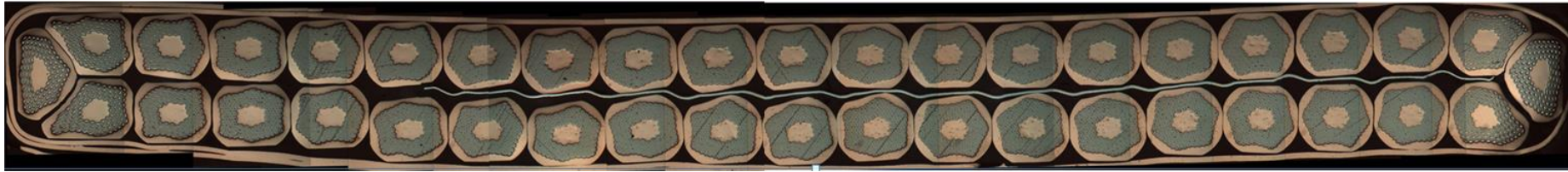

- Strands wound on spools mounted on a rotating drum
- Strands twisted around a conical mandrel into rolls
- The rolls compact the cable and provide the final shape

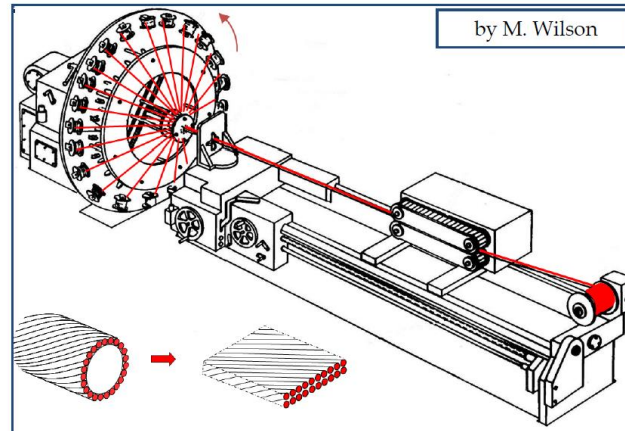

# The cable insulation

The cable insulation must feature

- Good **electrical properties** to withstand turn-to-turn  $V$  after a quench
- Good **mechanical properties** to withstand high pressure conditions
- **Porosity** to allow penetration of helium (or epoxy)
- **Radiation hardness**

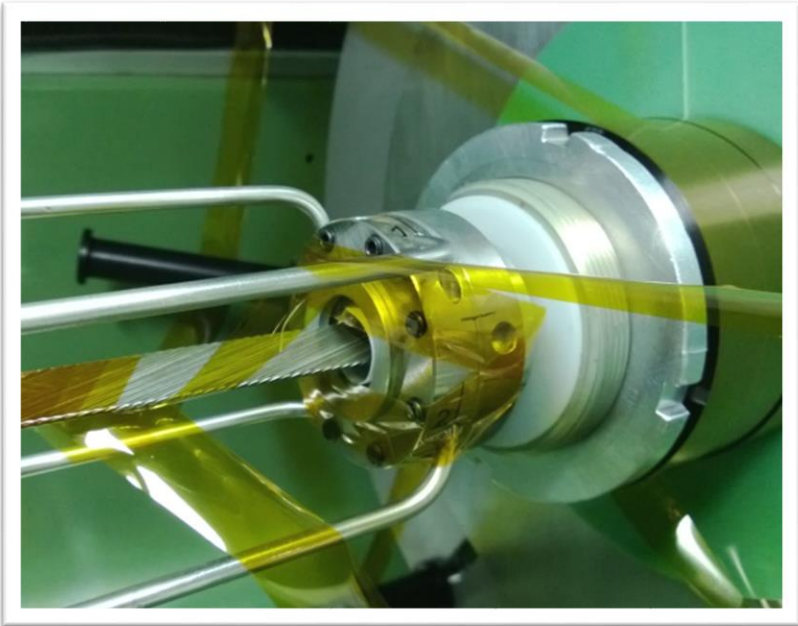

Polyimide insulation for Nb-Ti



Fiber glass insulation for Nb<sub>3</sub>Sn

# How to create a dipole field?

## Perfect dipole

- Within a cylinder carrying  $j_0$ , the field is perpendicular to the radial direction and proportional to the distance to the centre  $r$ .

$$B = -\frac{\mu_0 j_0 r}{2}$$

- Combining the effect of two intersecting cylinders

$$B_x = \frac{\mu_0 j_0 r}{2} \{-r_1 \sin \theta_1 + r_2 \sin \theta_2\} = 0$$

$$B_y = \frac{\mu_0 j_0 r}{2} \{-r_1 \cos \theta_1 + r_2 \cos \theta_2\} = -\frac{\mu_0 j_0}{2} s$$

## But...

- The aperture is not circular
- Not easy to simulate with a flat cable

The idea: reproduce a  $\cos\theta$  current distribution with a cable (Rectangular cross-section and constant  $J$ )

It will not be a perfect field...but it can be pretty close!

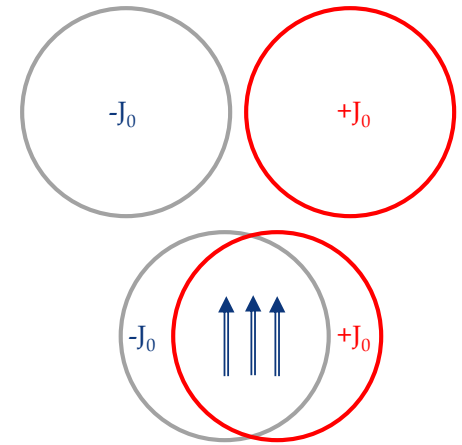

From ideal to practice configuration

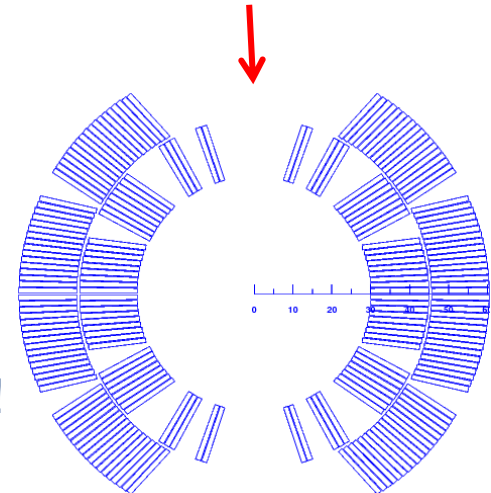

# Coil fabrication

- The coil: most **critical component** of a superconducting magnet
- **Cross-sectional accuracy** of few tens of micrometers over ~15 m
- Manufacturing tolerances (~30  $\mu\text{m}$  on blocks position) are accounted as random components for field quality.

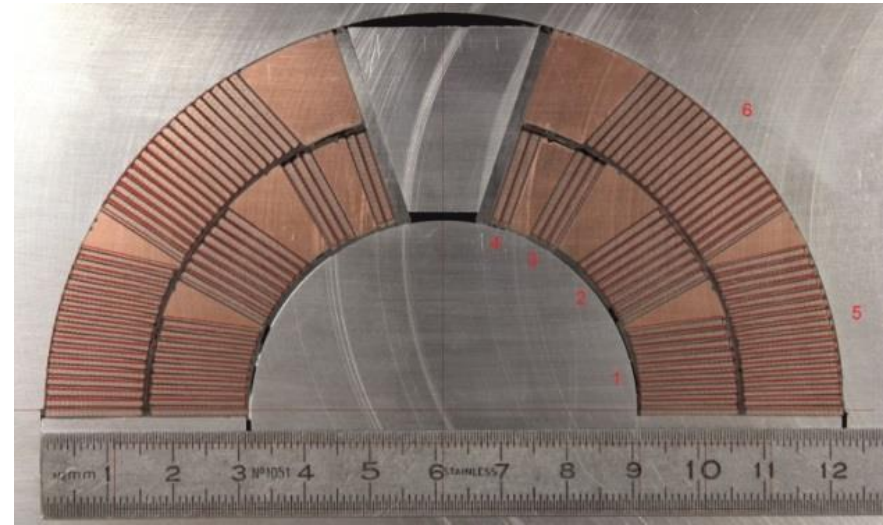

Cross section of a  $\text{Nb}_3\text{Sn}$  practice coil

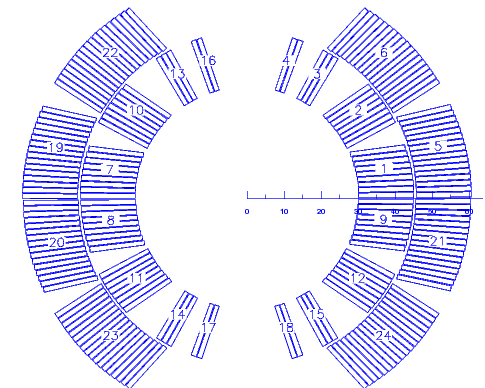
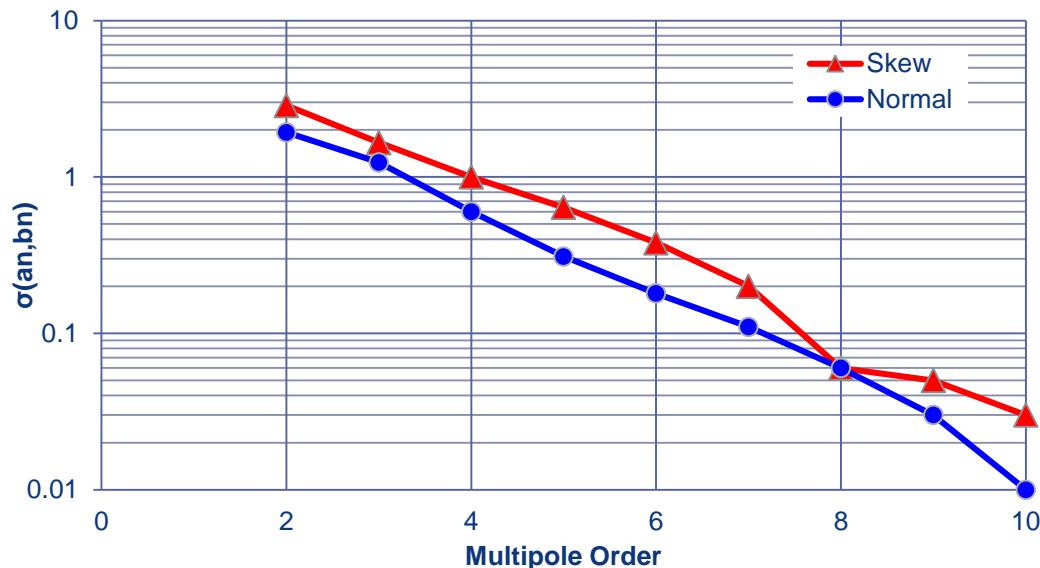

# Coil fabrication ( $\text{Nb}_3\text{Sn}$ )

## Winding & Curing

The cable is wound around a pole on a mandrel.  
A ceramic binder is applied and cured ( $T \sim 150\text{ C}$ ) to have a rigid body easy to manipulate.

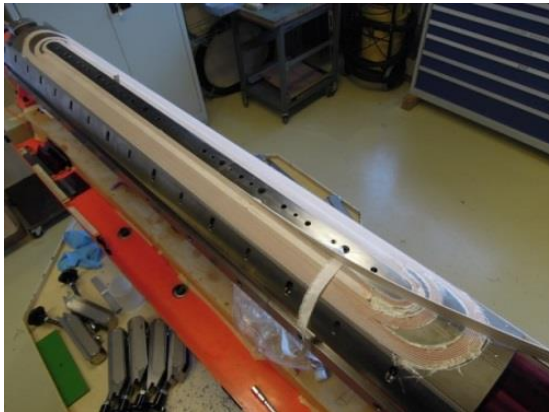

## Reaction

Sn and Nb are heated to  $650\text{-}700\text{ C}$  in vacuum or inert gas (argon)  $\rightarrow \text{Nb}_3\text{Sn}$

**The cable becomes brittle**



## Impregnation

In order to have a **solid block**, the coil placed in a impregnation fixture  
The fixture is inserted in a vacuum tank, evacuated  $\rightarrow$  **epoxy injected**

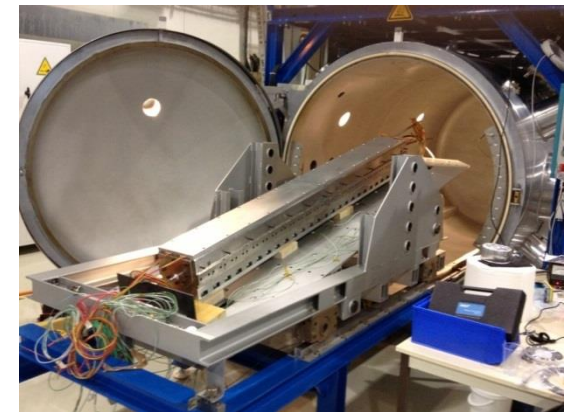



# Coil at different manufacturing steps

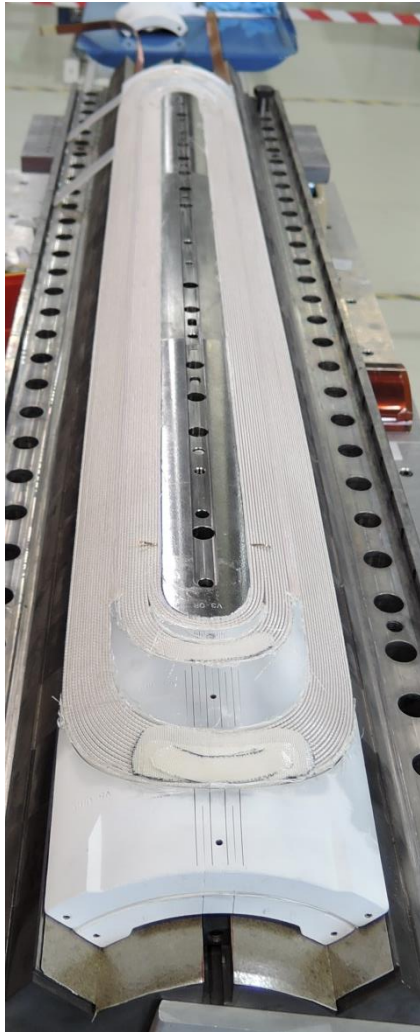

After curing



After reaction

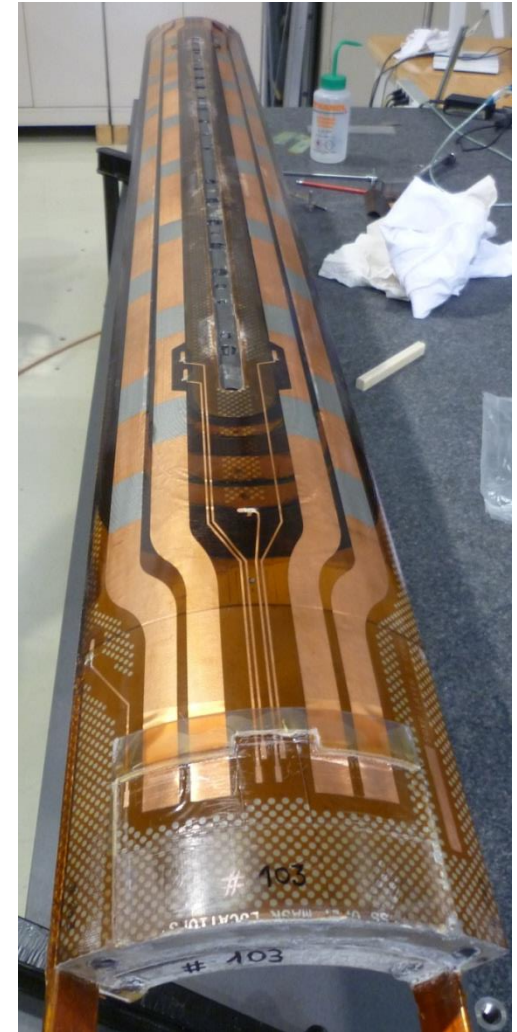

After impregnation

# Corrective actions

Having a small error margin with such as complex process, one should be ready to react in case the field quality is not within the specified limits

**Coil shimming** to fine tune field quality in case a systematic deviation is observed during production.

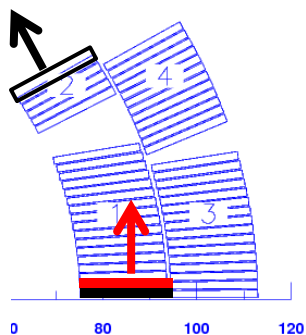

+100  $\mu\text{m}$  Mid plane IL  
-100  $\mu\text{m}$  Pole IL

$$\Delta b_6 = -3.4$$

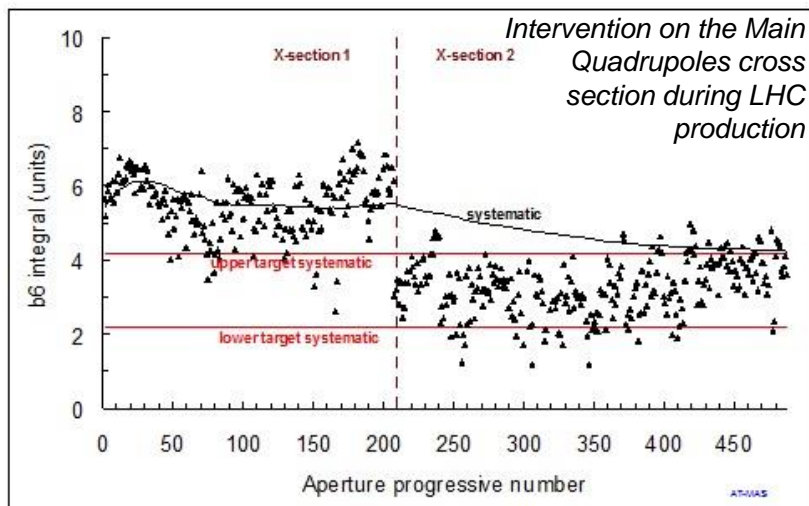

**Ferromagnetic shimming**, to correct field quality errors due to asymmetries.

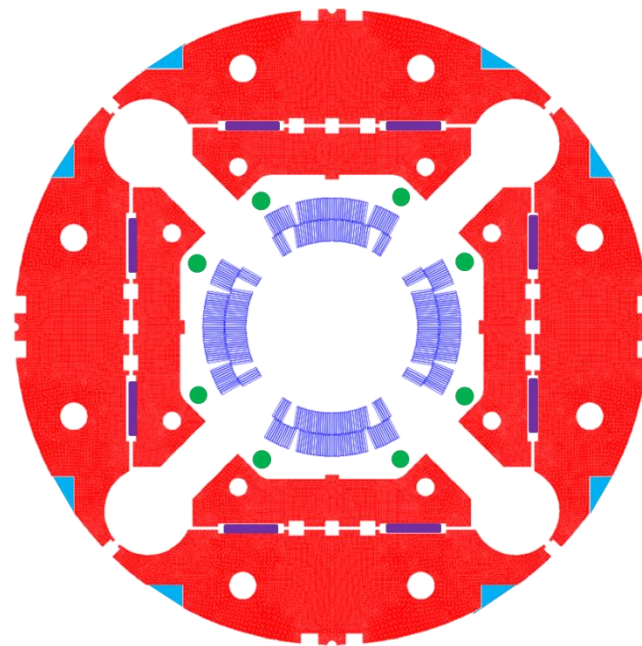

# Mechanical design

- In the presence of a magnetic field  $\mathbf{B}$ , an electric charged particle  $q$  in motion with a velocity  $\mathbf{v}$  is acted on by a force  $\mathbf{F}_L$  called electro-magnetic (Lorentz) force [N]:

$$\vec{F}_L = q\vec{v} \times \vec{B}$$

- A conductor element carrying current density  $J$  (A/mm<sup>2</sup>) is subjected to a force density  $\mathbf{f}_L$  [N/m<sup>3</sup>]

$$\vec{f}_L = \vec{J} \times \vec{B}$$

Some examples (values per aperture):

## **Nb-Ti LHC MB (8.3 T)**

- $F_x = 340 \text{ t}$  per meter
- ~300 compact cars
- $F_z = 27 \text{ t}$

## **Nb<sub>3</sub>Sn DS dipole (11T)**

- $F_x = 620 \text{ t}$  per meter
- $F_z = 47 \text{ t}$

# Deformation and stress

- Effect of e.m forces
  - change in **coil shape** → effect on field quality
  - a **displacement** of the conductor → potential release of frictional energy
  - Nb-Ti magnets: possible **damage** of kapton **insulation** at ~150-200 MPa.
  - Nb<sub>3</sub>Sn magnets: possible **conductor degradation** at about 150-200 MPa.
- All the components must be below stress limits.

LHC dipole at 0 T

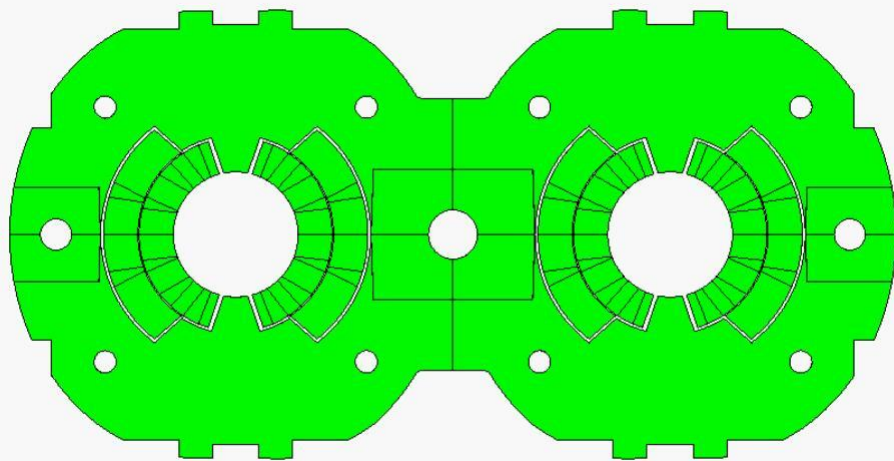

LHC dipole at 9 T

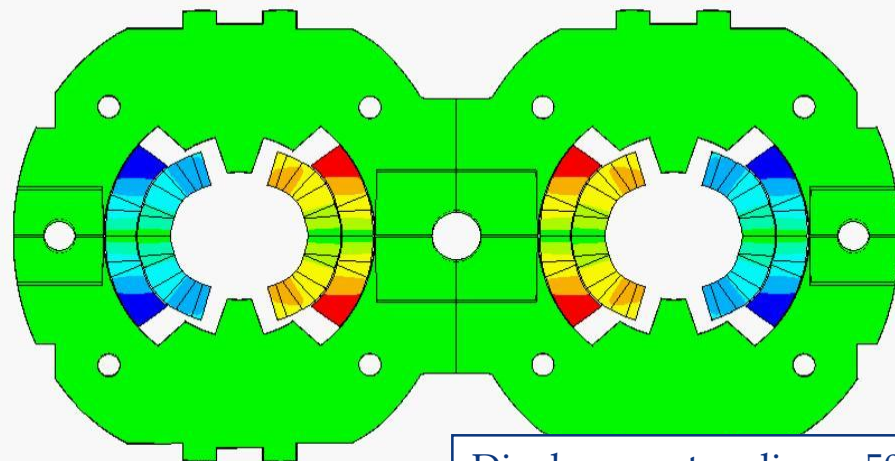

By P. Ferracin

Displacement scaling = 50

# Overview of the coil stress

By P. Ferracin

1. **Collaring:** By clamping the coils, the collars provide

- coil **pre-stressing**;
- **rigid support** against e.m. forces
- **precise cavity**

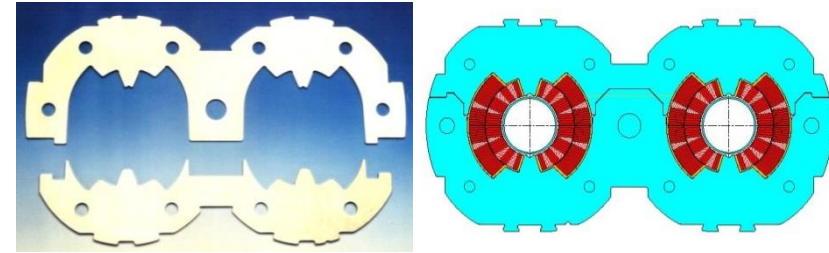

2. **Yoking:** Ferromagnetic yoke around the collared coil provide

- Magnetic function
- Mechanical function (increase the rigidity of the coil support structure and limit radial displacement)
- Alignment, assembly features...

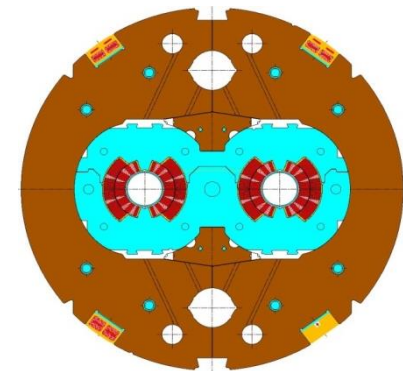

3. **Shell welding:** two half shells welded around the coil to provide

- Helium container
- Additional rigidity
- If necessary, the welding press can impose the desired curvature on the cold mass

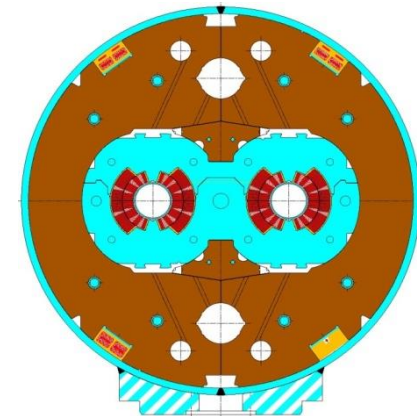

Some nice pictures of how this happens...

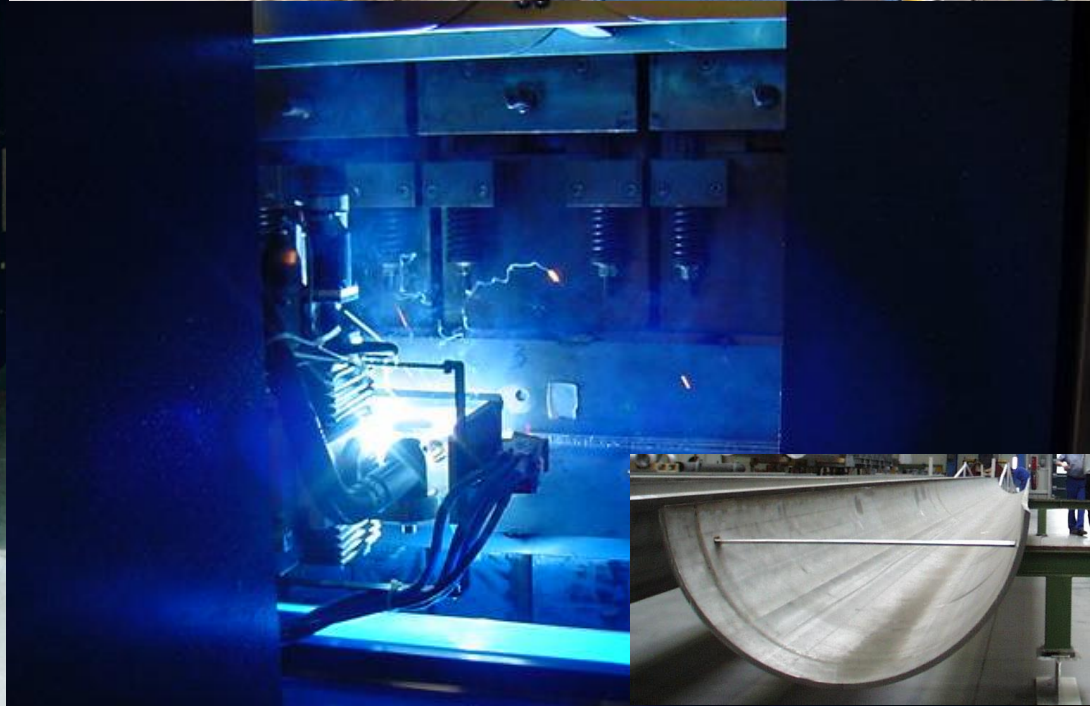
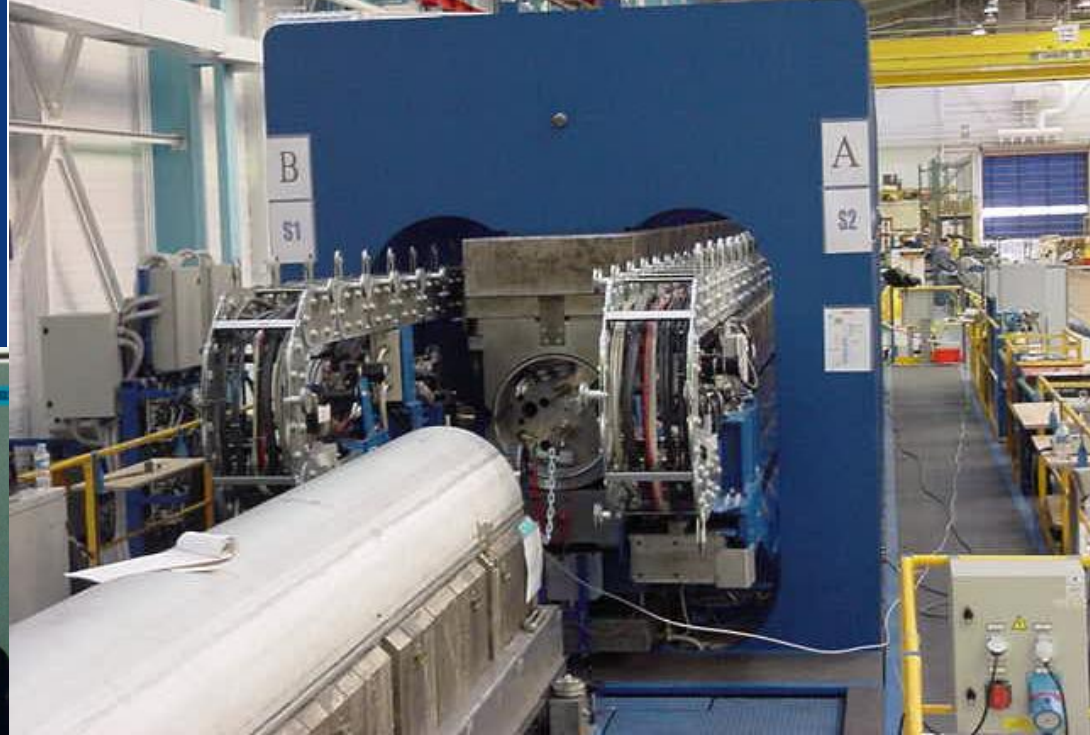

# Overview of coil stress

## 4. Cool-down

- Components shrink differently
  - Again, coil positioning within 20-50  $\mu\text{m}$
- Significant **variations of coil stress**

## 5. Excitation

- The pole region of the coil unloads
  - Depending on the pre-stress, at nominal field the coil may unload completely

All these contributions taken into account in the  
**mechanical design:**

- Minimize **coil motion** (pre-stress)
- Minimize **cost and dimension** of the structure
- Maintain the maximum stress of the component **below the plasticity limits**
- ...and for (especially) Nb<sub>3</sub>Sn coils, **limit coil stress** (150-200 MPa).

# Quench Definition

**Quench** = irreversible transition to normal state

- **Heat generation > cooling**

## Why do magnets quench?

Thermal energy released by

- **Mechanical events**
  - Frictional motion
  - Epoxy cracking
- **Electromagnetic events**
  - Flux-jumps ,AC loss
- **Thermal events**
  - Degraded cooling
- **Nuclear events**
  - Particle showers

## What do we do when a magnet quenches?

Conversion **magnetic energy**

→

**thermal energy** (redistribute the energy in the whole coil volume, joule heating)

$$E_m = \int_V \frac{B^2}{2\mu_0} dv = \frac{1}{2} LI^2$$

→

$$J^2 \eta$$

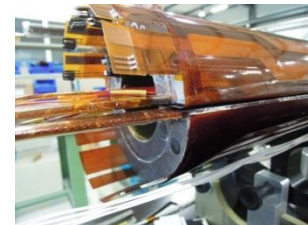



# Quench

In the case of the LHC, the magnetic energy is completely dissipated in the internal resistance, which depends on the temperature and volume of the normal zone

(when increasing the temperature the material becomes resistive → resistance increase → current decrease (fix voltage))

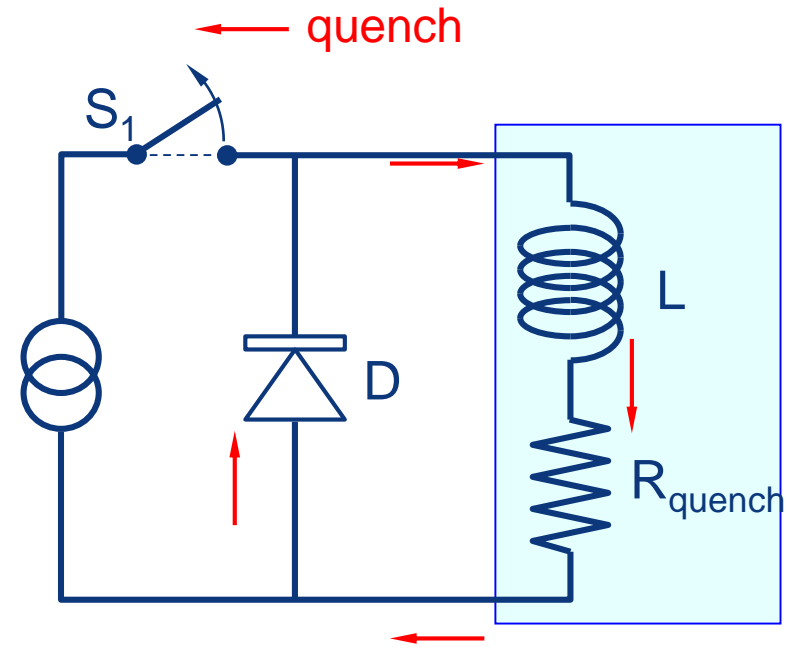
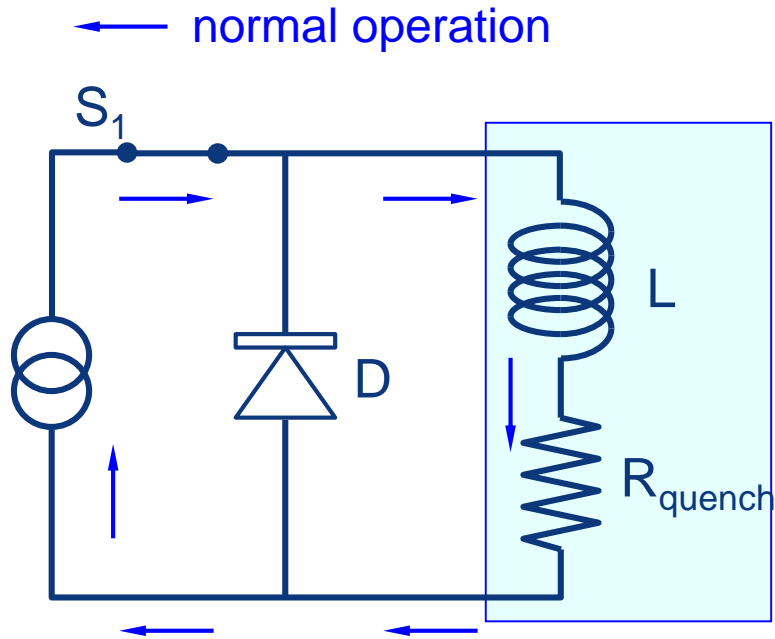

# The quench event: summary

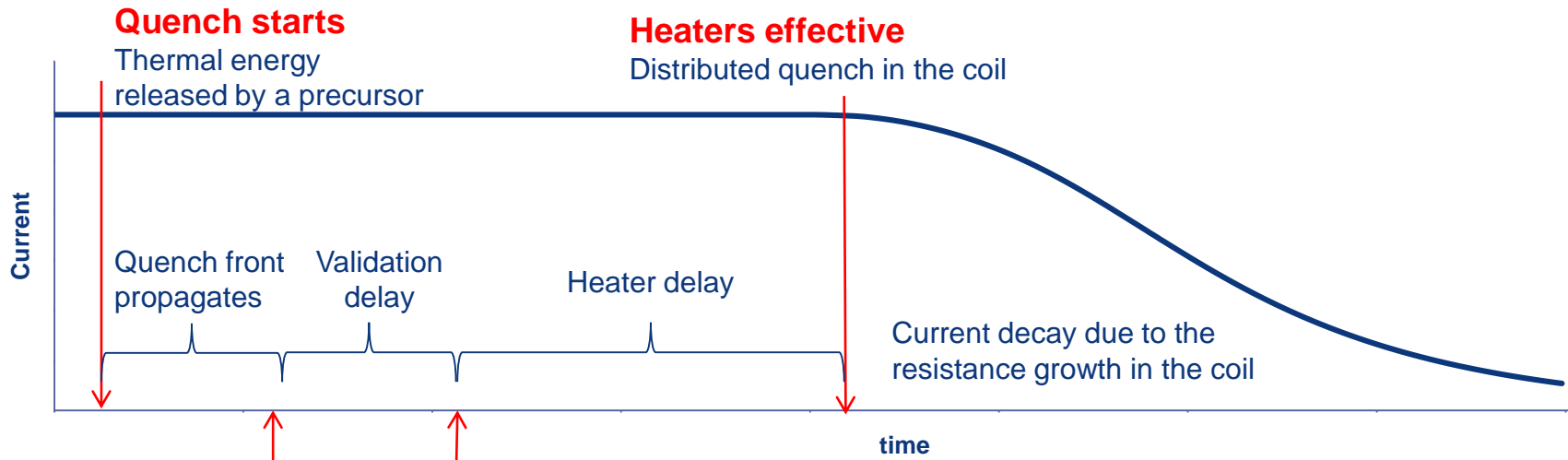

**Quench detected**    **Quench validated**  
(power supply off, heaters fired)

## Typical time scale:

- From quench start to quench detected ~ 5 ms
- Validation delay ~ 10 ms
- Heater delay ~ 20 ms
- Current decay ~ 100-200 ms

Maximum acceptable temperature: **350K**

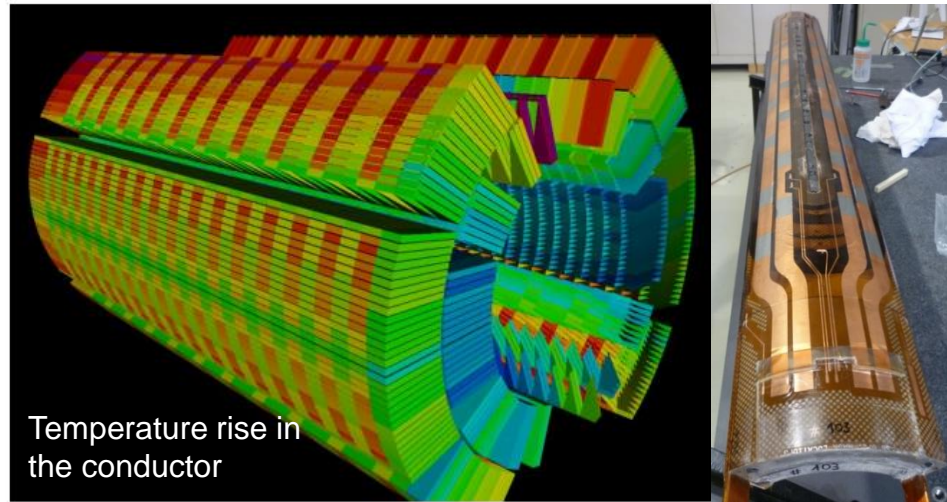

# Contents

- The LHC, its energy and the need to use superconducting materials
- Superconducting magnets
  - Conductor
  - Magnetic design
  - Mechanical design
  - Quench protection
- **Cryogenics**
- **Vacuum**
- **Interconnections**
- **Cavities, collimators, detectors, civil engineering, transport.**
- Technological challenges for the future machines

# Cryogenics: Low temperatures, high performance

## Large Hadron Collider (LHC):

Largest cryogenic system in the world and one of the coldest places on Earth.

## Main magnets:

Operate at a temperature of 1.9 K (-271.3°C), colder than the 2.7 K (-270.5°C) of outer space.



This requires 40,000 leak-tight pipe seals, 40 MW of electricity.  
120 tonnes of helium to keep the magnets at 1.9 K.

# Cryostat

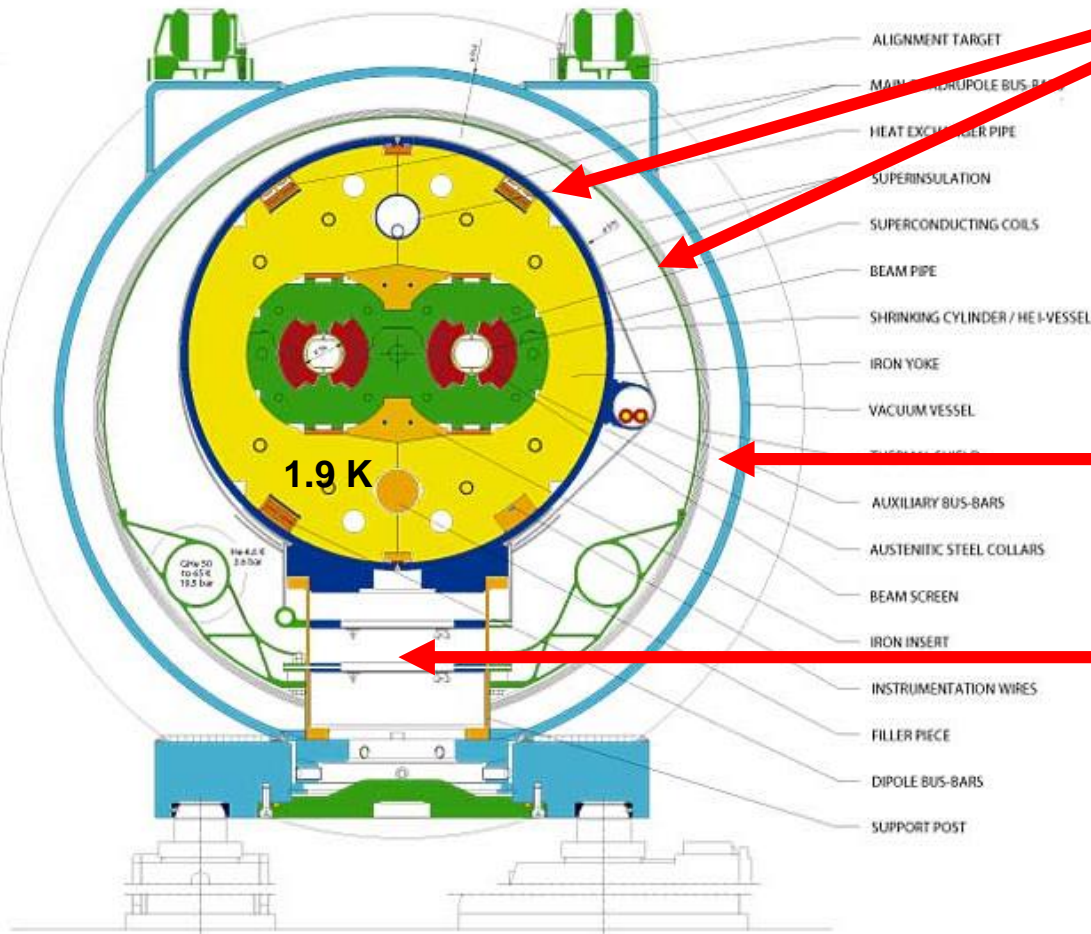

**Insulating material**



**Vacuum**

**Support** made with a composite material to reduce heat conduction.

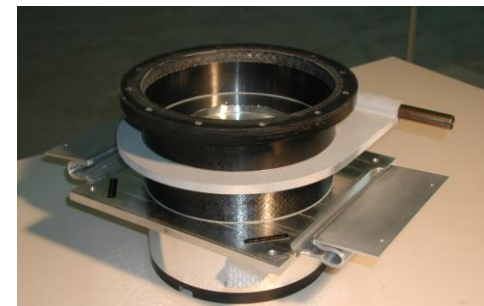

CERN AC/DI/MM — 2001/06

# Cryogenic System

The LHC cryogenics system is the biggest and most complex in the world

- 8 cryogenic plants (8 x 18kW @ 4.5 K)



- 24 km & 20 kW @ 1.8 K and special equipment in the tunnel

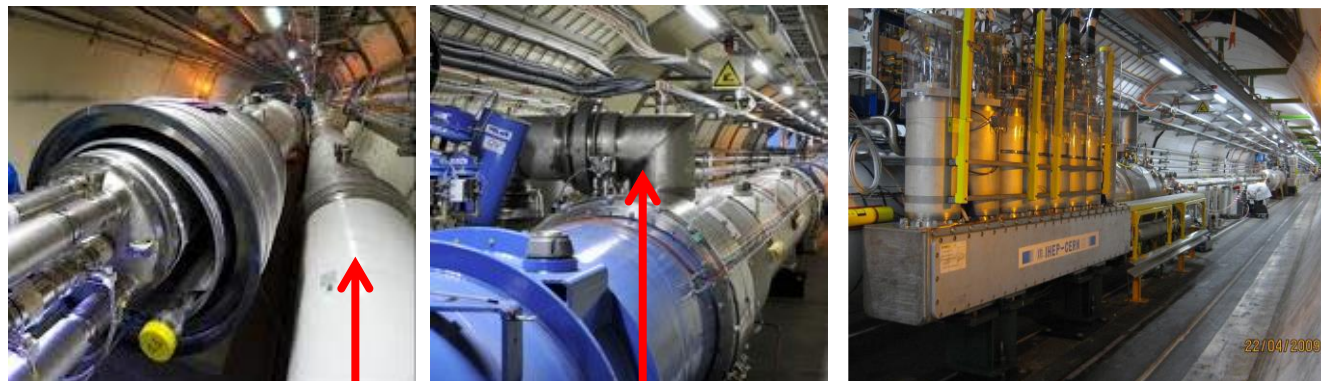

Cryogenic line

jumper

DFBs

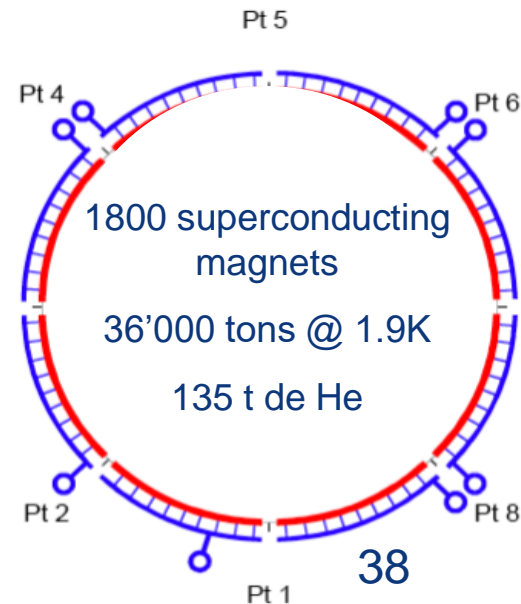

# Vacuum

In the LHC, there are three different vacuum systems with different aims:

1. Cryo-magnets
2. Helium distribution line (QRL)

} **Thermal insulator**  
50 km,  $10^{-6}$  mbar

3. Vacuum in the **beam** pipes.  
(54 km,  $10^{-10}$  to  $10^{-11}$  mbar)

*This means that we allow a leak of 1 litre each 30.000.000 years.*

*In the region where the beam circulates, vacuum almost as rarefied as that found on the surface of the Moon!!*

Largest operational vacuum system in the world, **Total length of vacuum piping: 104 km**



# Interconnections



Some key aspects of the interconnections::

- They have to have flexible components to compensate the thermal contraction ( $\sim 3\text{mm/m} \rightarrow 45\text{ mm/dipole}$ )
- It is very important to guarantee the electrical integrity of the 12 kA circuit.

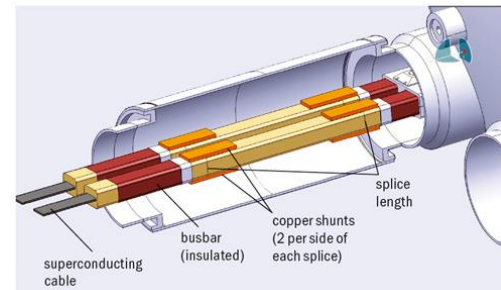



# Accelerating RF cavities

Main function of the cavities:

- Keep the particles properly **grouped** to ensure high luminosity in the interaction region.
- Provide **energy** to the beam during the **ramp**.

Technoloty: niobium coated copper superconducting cavities:

- Low energy losses.
- Large stored energy.
- They can fulfil the radio-frequency conditions required in the LHC.

On the Large Hadron Collider (LHC), each RF cavity is tuned to oscillate at 400 MHz.

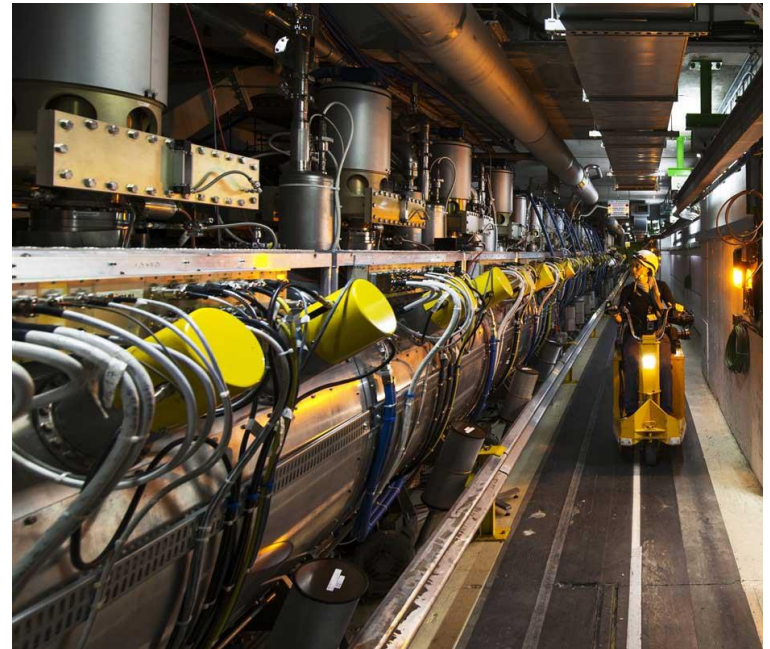

# Collimators

- The energy stored in the LHC beam is enough to melt almost 1 ton of copper!
- A small fraction of this energy is enough to provoke a quench in a superconducting magnet or even to destroy some parts of the accelerator..
- A fraction  $10^{-5}$  of the nominal beam energy will damage copper.
- The **function** of the collimators: **protect the accelerator** against unavoidable regular and irregular beam loss.

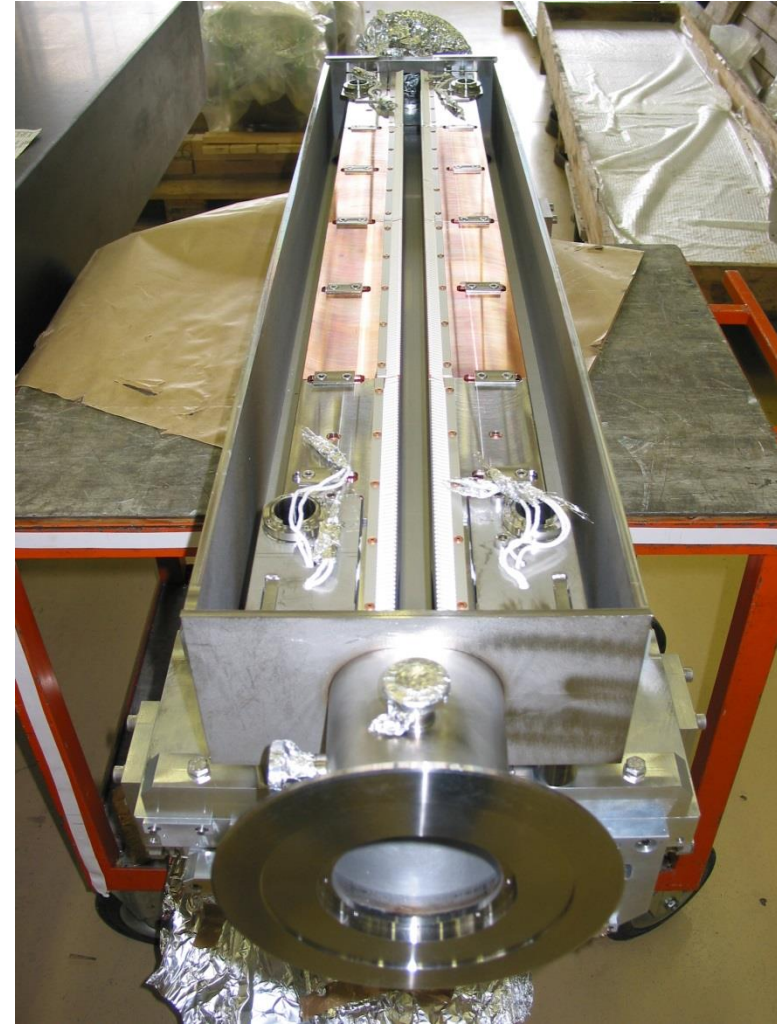

# Detectors

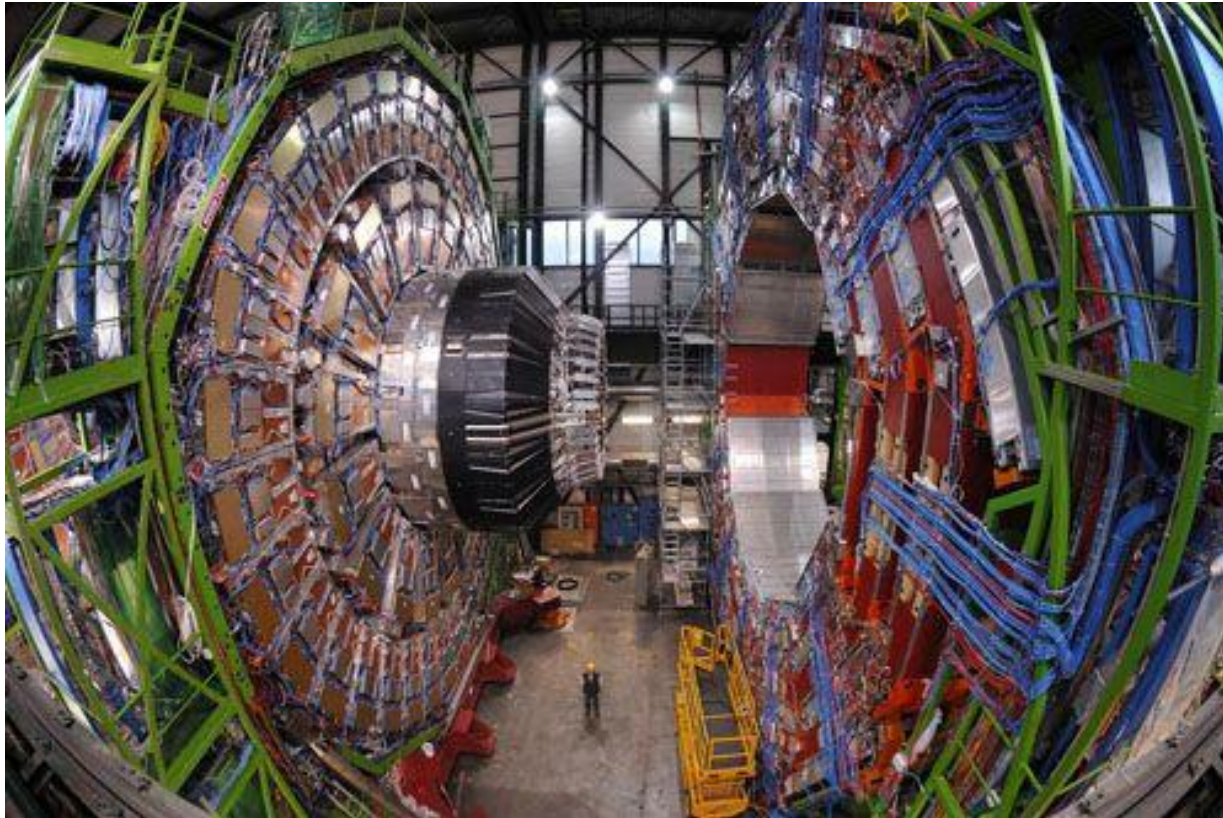

- Micro-electronics
- Data acquisition and treatment
- Superconducting magnets
- Cryogenics
- Powering
- Mechanical structures
- Ultra high vacuum

# Civil Engineering

- The LHC is built 100 m below ground.
- Most of the tunnel was built at the time of LEP, only the caverns for ATLAS and CMS had to be built for the LHC (dimensions 35m width, 42m height, and 82m length)
- Additional constrains during the design/construction:
  - The impact on LEP had to be minimized (as it was running in parallel to the civil works)
  - The distance between detectors and data centres had to be minimized.
- Most of the HL-LHC civil engineering work completed during LS2, to avoid impact on LHC operation.



# Transport



# Contents

- The LHC, its energy and the need to use superconducting materials
- Superconducting magnets
  - Conductor
  - Magnetic design
  - Mechanical design
  - Quench protection
- Cryogenics
- Vacuum
- Interconnections
- Cavities, collimators, detectors, civil engineering, transport.
- Technological challenges for the future machines



# Hi-Lumi LHC

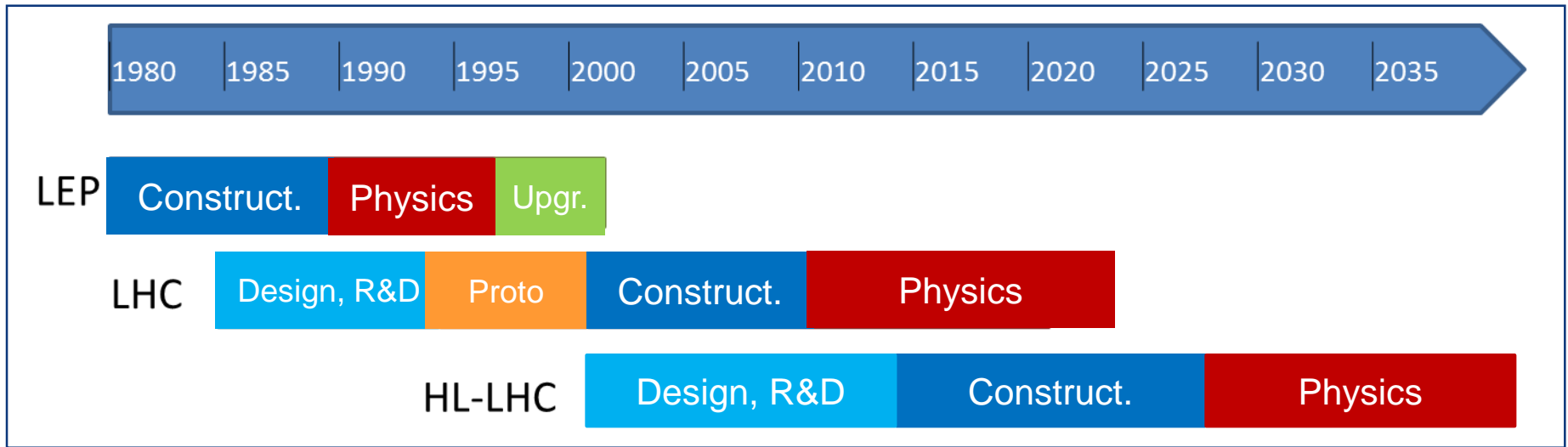

- From LHC to HiLumi LHC
  - Integrated  $L$ :  $\sim 300 \rightarrow 3000 \text{fb}^{-1}$
- Reduce beam size in Interaction regions (IR) by **factor 2**
- Triplet quadrupole **aperture doubled** ( $70 \text{ mm} \rightarrow 150 \text{ mm}$ )

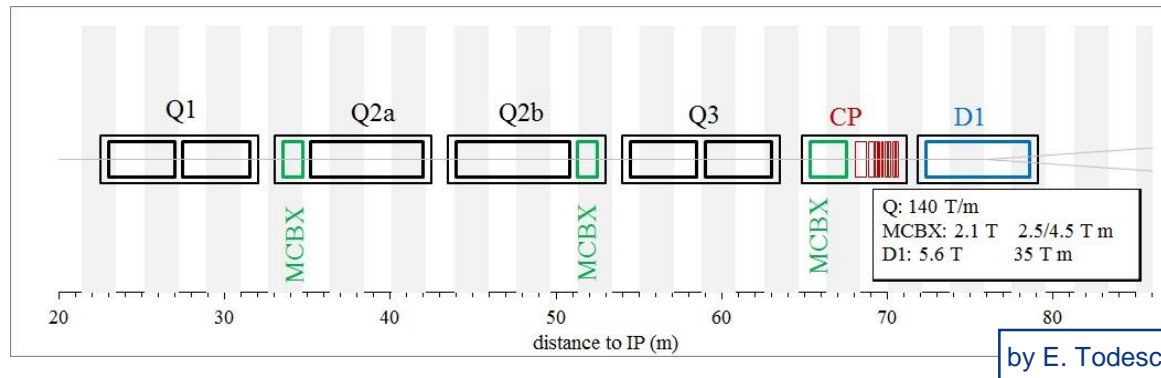

# HiLumi LHC

1.2 km of machine to be replaced

## The challenges:

- Produce **Nb<sub>3</sub>Sn** magnets “accelerator quality” (up to now only NbTi).
- Coil technology for 7 m Nb<sub>3</sub>Sn ( $L_{\max}$  up to now 3.5m)
- Electromagnetic forces:
  - ~4 times in straight section and ~6 times in the ends with respect to current triplets
- Quench protection
  - Large stored energy per unit volume
- **Crab cavities**
  - New concept
- **Civil engineering:** how to run in parallel the LHC and the required engineering work?
- **Radiation** protection

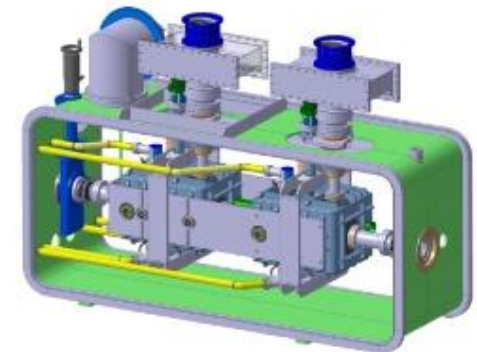
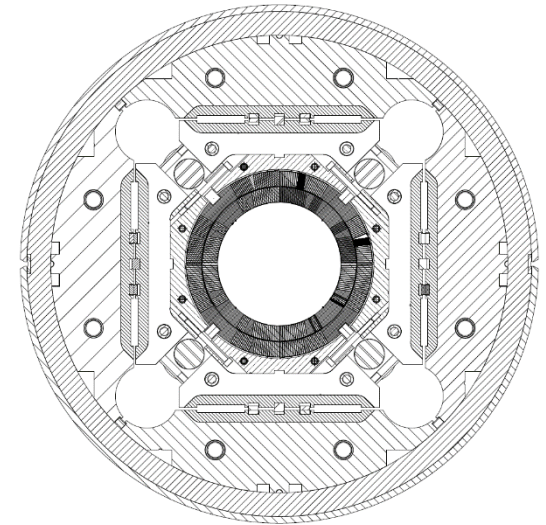



# MQXFB magnet construction activities, as in 29/03/2022

MQXFBP2:  
Temporary cold mass → Final cold mass

MQXFBP3:  
Magnet → Temporary cold mass

MQXFB02:  
Coils → Magnet



# Post LHC: The FCC playground

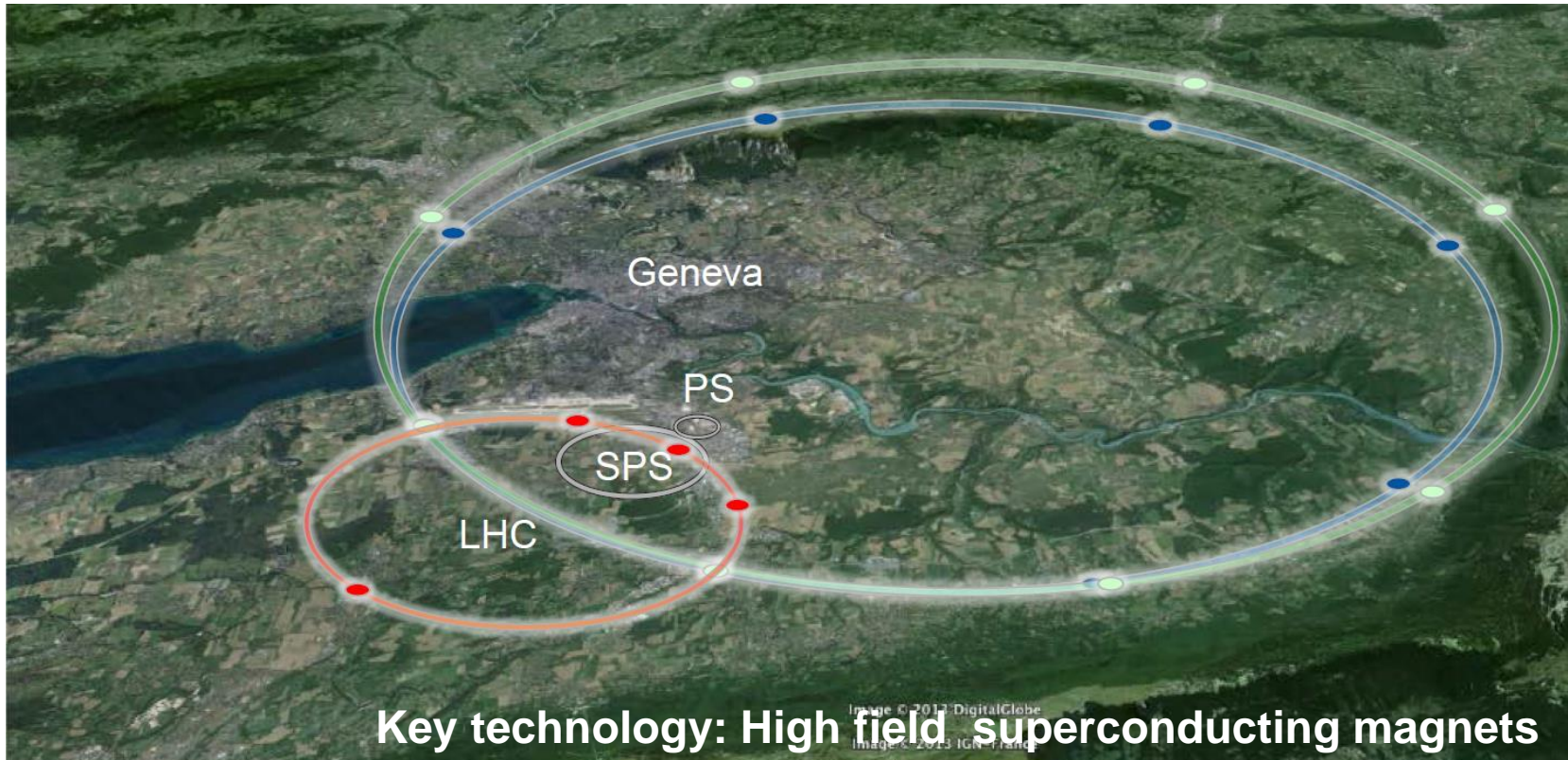

## LHC

27 km, 8.33 T  
14 TeV (c.o.m.)

1300 tons NbTi

## HE-LHC

27 km, **20 T**  
33 TeV (c.o.m.)

3000 tons LTS  
700 tons HTS

## FCC-hh

80 km, **20 T**  
100 TeV (c.o.m.)

9000 tons LTS  
2000 tons HTS

## FCC-hh

100 km, **16 T**  
100 TeV (c.o.m.)

6000 tons Nb3Sn  
3000 tons NbTi

# Key technologies for future accelerators

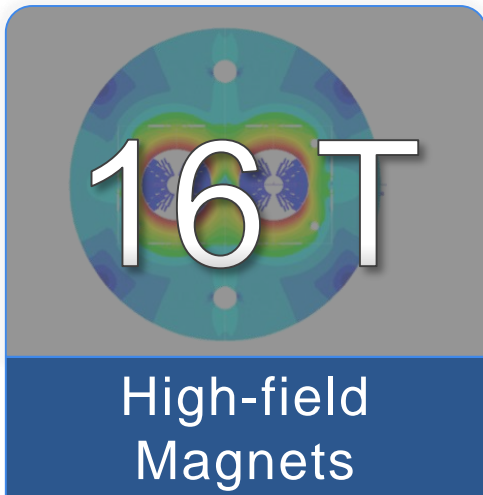

16 T

High-field Magnets

A circular cross-section of a magnet with a central bore, showing a color-coded field distribution. The text '16 T' is overlaid in large white font.

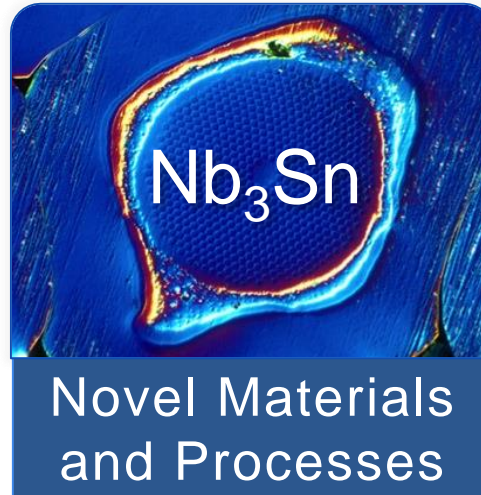

Nb<sub>3</sub>Sn

Novel Materials and Processes

A microscopic image of a Nb<sub>3</sub>Sn superconductor surface, showing a textured, blue and yellow structure. The text 'Nb<sub>3</sub>Sn' is overlaid in white font.



Large-scale Cryogenics

A photograph of a large, orange, spherical cryogenic vessel with a metal frame, likely used for storing cryogenic liquids. The text is overlaid in white font.

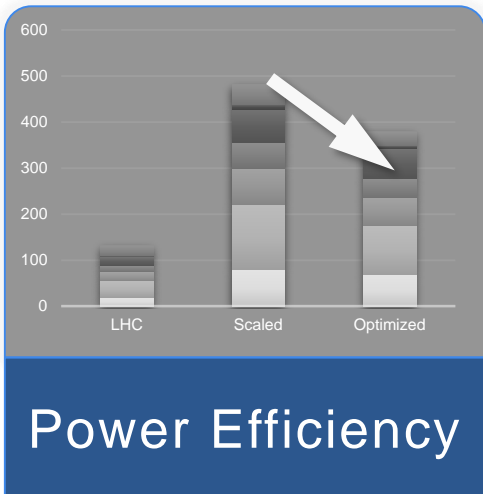

Repair & Maintenance

Reliability & Availability

An image of a blue and red adjustable wrench and a silver screwdriver crossed. The text 'Repair & Maintenance' is overlaid in white font.



2.0

Global Scale Computing

A blue cloud icon with a yellow and orange striped base. The text '2.0' is overlaid in large white font.

# The CLIC playground



- **Electron-positron machine** (Linear machine, particles would otherwise lose an enormous amount of energy circulating in a circular structure as the LHC);
- Accelerating gradient: 360 GeV to 3 TeV;
- Very high precision on the components! For some parts, the mechanical tolerances are  $2\ \mu\text{m}$ , a big challenge from the manufacturing point of view;
- Key technology: High-gradient accelerating structures.
- CLIC aims at an acceleration of 100 MV/m, 20 higher than the LHC;
- Requires a nm stabilization system for quadrupole magnets.

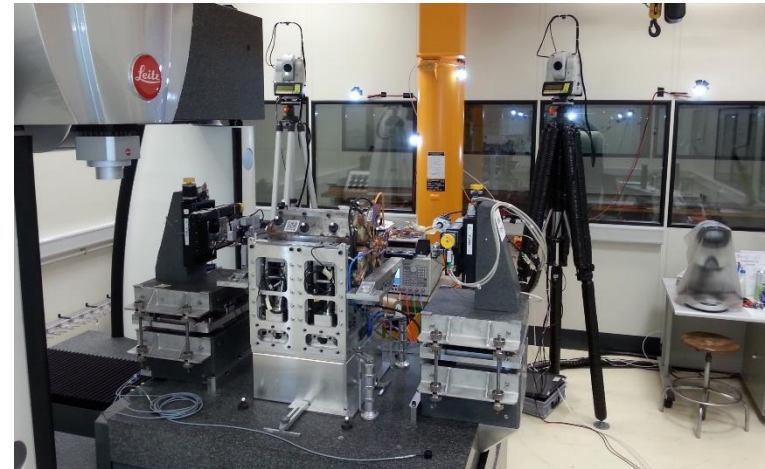

Courtesy H.M. Durand (EN-ACE), K. Artoos (EN-MME)

# Thank you for your attention!!

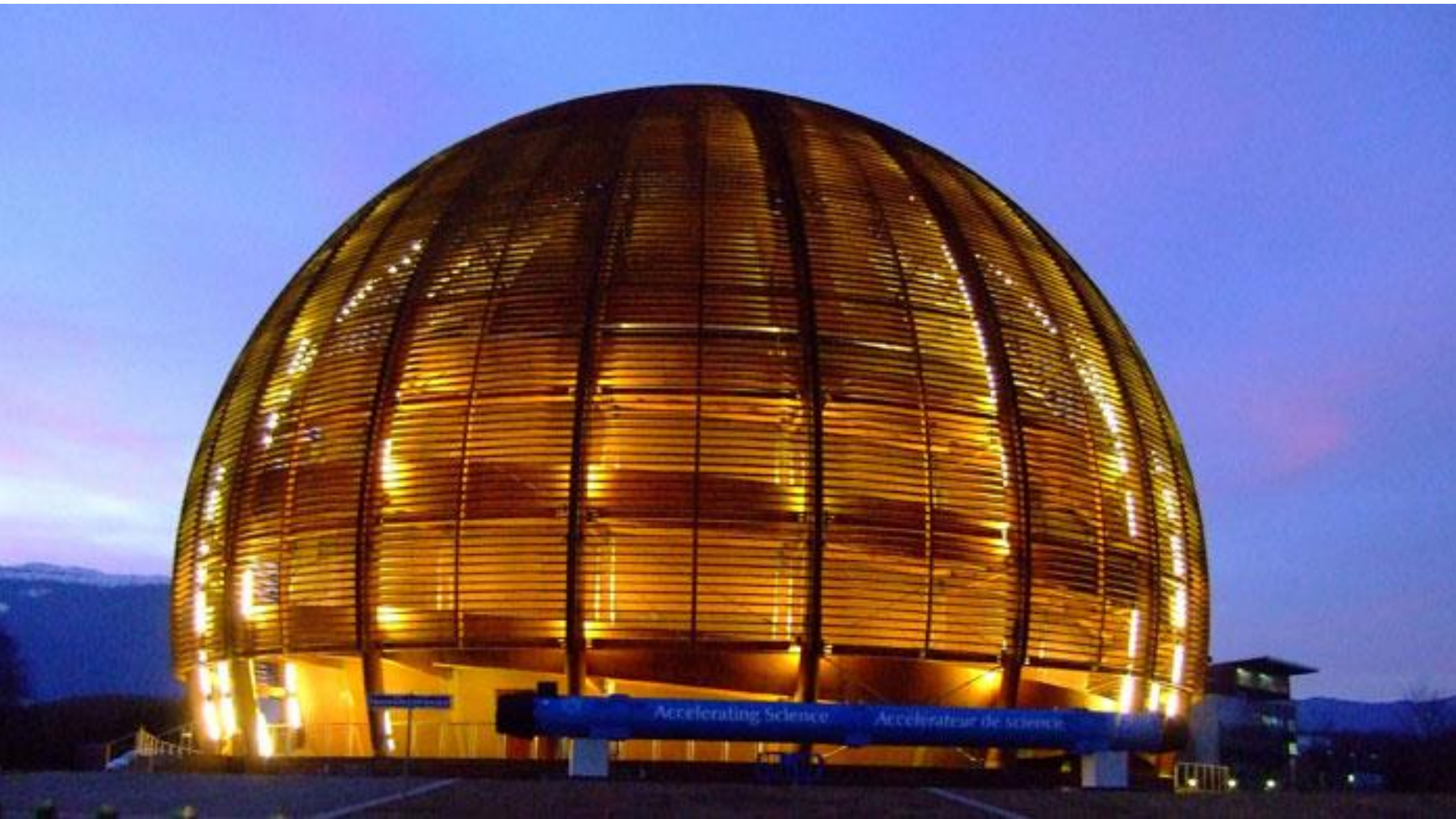

# References

## Acknowledgements

To L. Bottura, P. Ferracin and E. Todesco, who gave lectures in different courses, from which I took material and ideas.

To Google and Wikipedia, who helped to find out most of the pictures and a lot of information.

## Books

- K.-H. Mess, P. Schmuser, S. Wolff, “*Superconducting accelerator magnets*”, Singapore: World Scientific, 1996.
- Martin N. Wilson, “*Superconducting Magnets*”, 1983.
- Fred M. Asner, “*High Field Superconducting Magnets*”, 1999.
- S. Russenschuck, “*Field computation for accelerator magnets*”, J. Wiley & Sons (2010).
- A. Devred, “Practical low temperature superconductors for electromagnets”, CERN Yellow report 2004-006.

## Review papers

- L. Bottura, L. Rossi, “Superconducting magnets for particle accelerators”, *Rev. Sci. Accel. Tech.* **5** 30003 (2012)
- A. Tollestrup, E. Todesco, ‘The development of superconducting magnets for use in particle accelerators: from Tevatron to the LHC’, *Rev. Sci. Accel. Tech.* **1** 185-210 (2008)

## Courses

- “*Course on Superconductivity for Accelerators*”. CERN Accelerator School. <https://cds.cern.ch/record/1507630>
- P. Ferracin, E. Todesco, S. Prestemon, “*Superconducting accelerator magnets*”, US Particle Accelerator School, [www.uspas.fnal.gov](http://www.uspas.fnal.gov).



# Additional slides

# HL-LHC magnet zoo

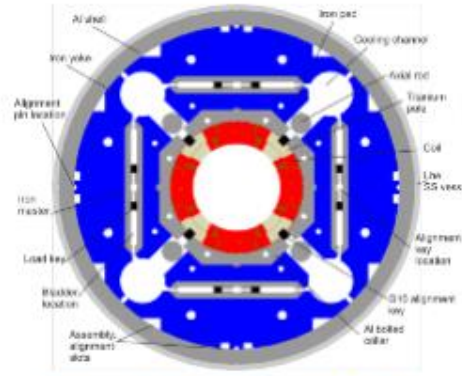

Triplet QXF (LARP and CERN)

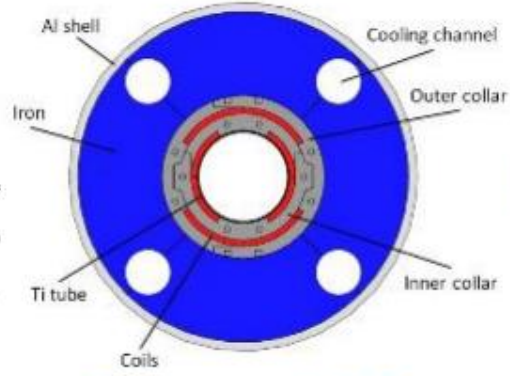

Orbit corrector (CIEMAT)

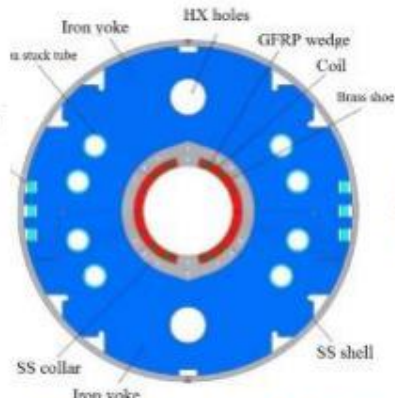

Separation dipole D1 (KEK)

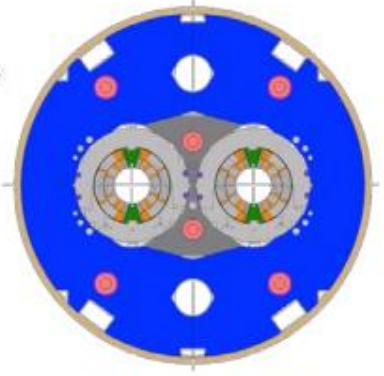

11 T dipole (CERN)

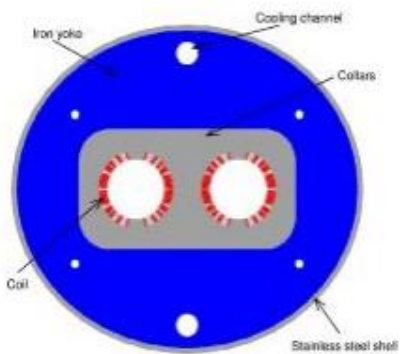

Recombination dipole D2 (INFN design)

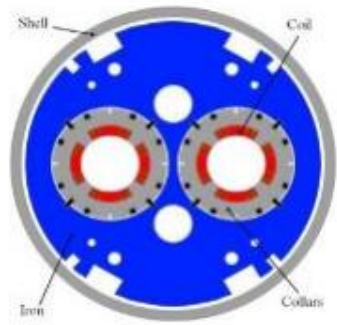

Q4 (CEA)

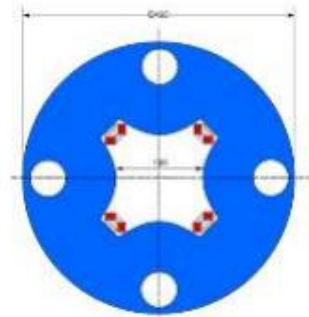

Skew quadrupole (INFN)

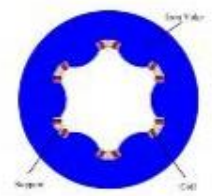

Sextupole (INFN)

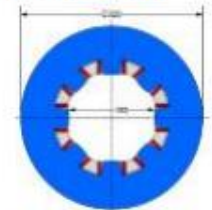

Octupole (INFN)

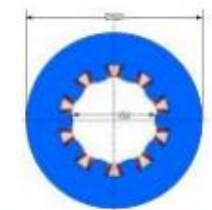

Decapole (INFN)

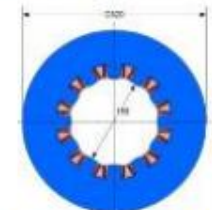

Dodecapole (INFN)

Approximately 200 magnets for HL-LHC



# Superconductivity

- For 40-50 years, only “**Type I**” superconductors were known.

- Perfect diamagnetism. With  $T < T_c$  magnetic field is expelled
- But, the  $B$  must be  $<$  **critical field  $B_c$** . Otherwise, superconductivity is lost
- Unfortunately,  $B_c$  *very low* ( $\leq 0.1$  T), not practical for electromagnets

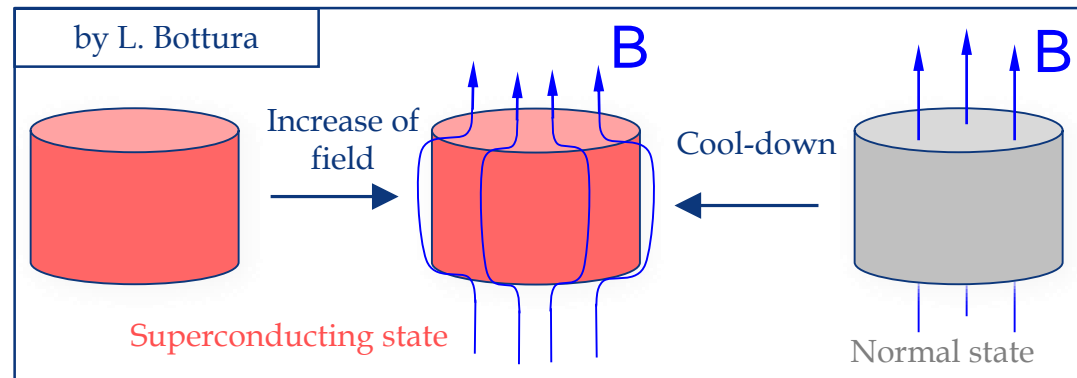

- Then, in the 50's, “**Type II**” superconductors

- Between  $B_{c1}$  and  $B_{c2}$ : mixed phase
  - $B$  penetrates as flux tubes: *fluxoids*
- Much higher fields and link between  $T_c$  and  $B_{c2}$

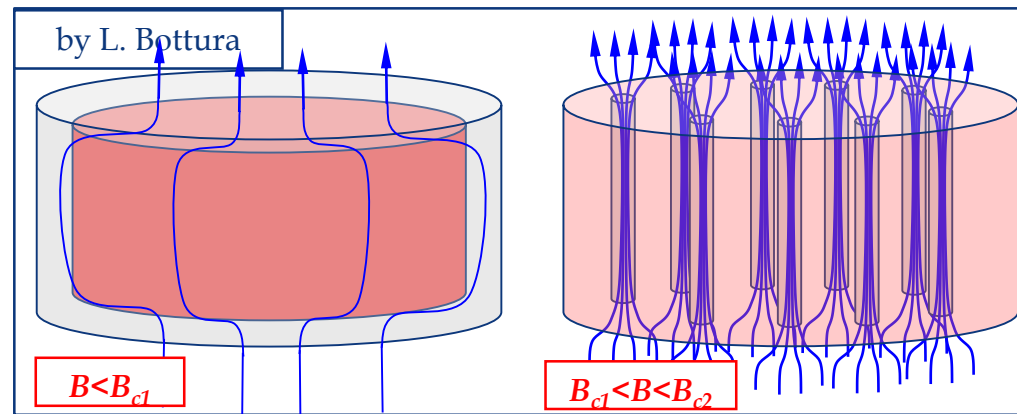

# The strand: multifilament wire

## WHY a multi-filament wire?

### 1. Flux jumps

Thermal disturbance  $\rightarrow$  the local change in  $J_c \rightarrow$  motion or “**flux jump**”  $\rightarrow$  power dissipation  
Stability criteria for a slab (adiabatic condition)

$$a \leq \sqrt{\frac{3\gamma C(\theta_c - \theta_0)}{\mu_0 j_c^2}}$$

$a$  is the half-thickness of the slab  
 $j_c$  is the critical current density [ $\text{A m}^{-2}$ ]  
 $\gamma$  is the density [ $\text{kg m}^{-3}$ ]  
 $C$  is the specific heat [ $\text{J kg}^{-1}$ ]  
 $\theta_c$  is the critical temperature.

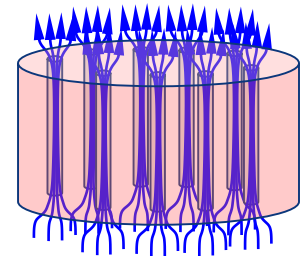

$$B_{c1} < B < B_{c2}$$

### 2. Quench protection

- Superconductors have a very high normal state resistivity.  
*If quenched, could reach very high temperatures in few ms.*
- If embedded in a **copper matrix**, when a quench occurs, current redistributes in the low-resistivity matrix  $\rightarrow$  **lower peak temperature**

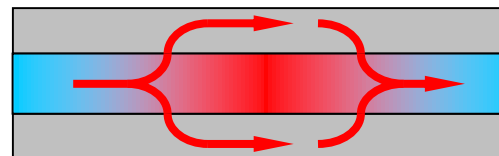

# The strand: multifilament wire

## 3. Persistent currents

When a filament is in a varying  $B_{ext}$ , its inner part is shielded by currents distribution in the filament periphery

They **do not decay** when  $B_{ex}$  is held constant  $\rightarrow$  **persistent currents**

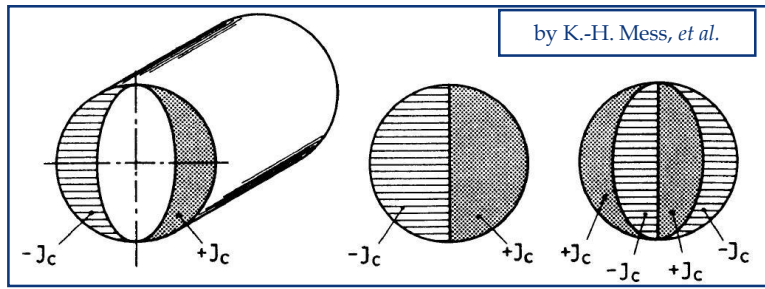

These currents produce **field errors** that are particularly important at low energy (**when the beam is injected**), which are proportional to the filament diameter ( $d_{sub}$ ) and the current density.

$$M(B) \propto d_{sub} \cdot J_c(B)$$

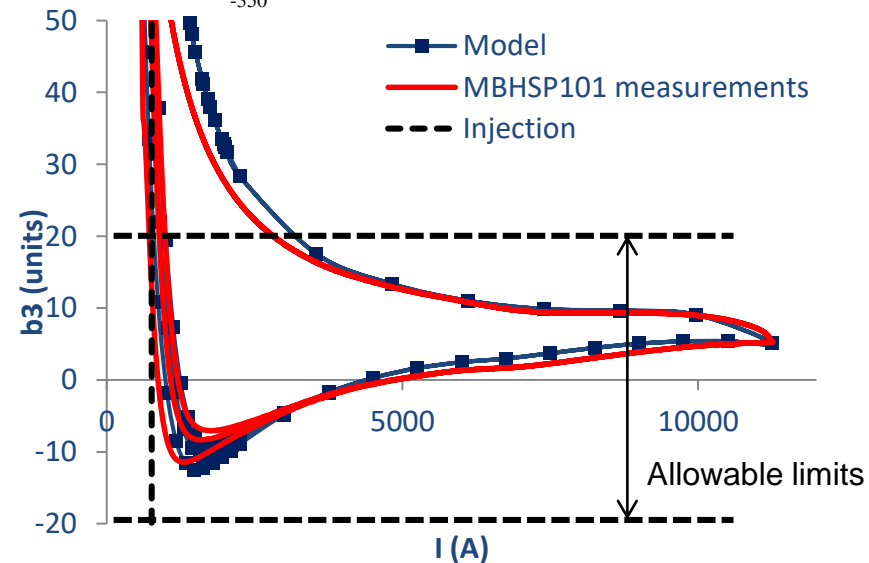
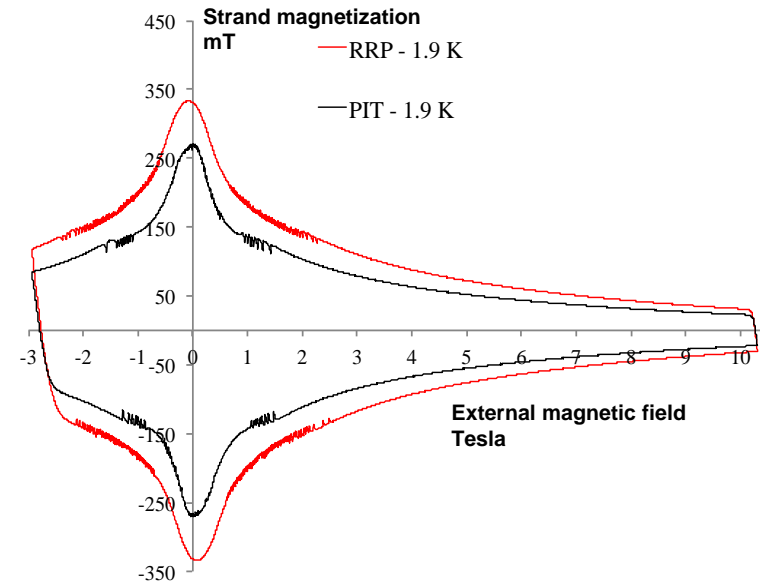

# The strand: multifilament wire

## 4. Inter-filament coupling

- When a multi-filamentary wire is subjected to a time varying magnetic field, **current loops** are generated between filaments.
- If filaments are straight, large loops with large currents → **ac losses**
- If the strands are magnetically coupled the effective filament size is larger → **flux jumps**

To reduce these effects, filaments are **twisted**

- twist pitch of the order of 20-30 times of the wire diameter.

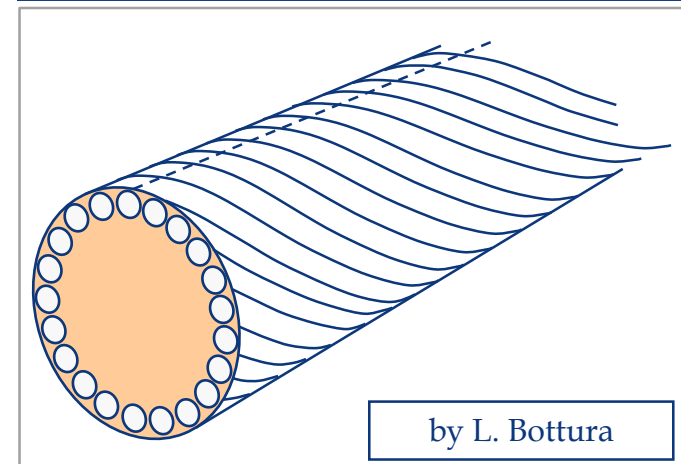
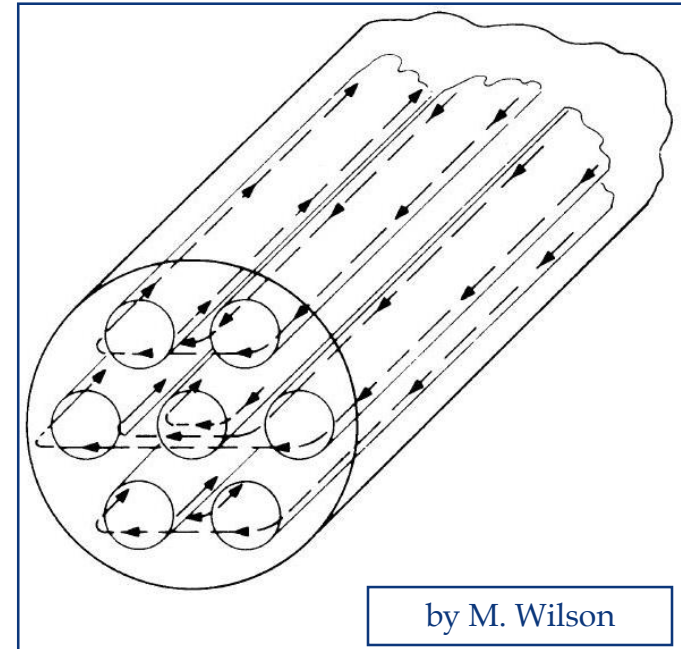

# Iron yoke

An **iron yoke** usually surrounds the collared coil – it has several functions:

- Keep the return magnetic flux close to the coils, thus avoiding **fringe fields**
- In some cases the iron is partially or totally contributing to the **mechanical structure**
- Considerably **enhance the field** for a given current density
  - The increase is relevant (10-30%), getting higher for thin coils
  - This allows using lower currents, easing the protection

When the iron **saturates** ( $\sim 2\text{T}$ ):

- The main field is not  $\propto$  current  $\rightarrow$  transfer function  **$B/i$  drops** of several (tens) of units
- Since the field in the iron has an azimuthal dependence, some parts of the iron can be saturated and others not  $\rightarrow$  **variation of low order harmonics**

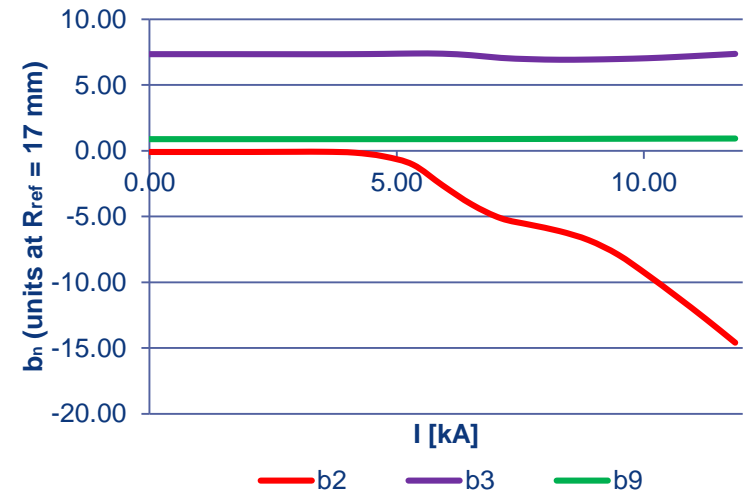
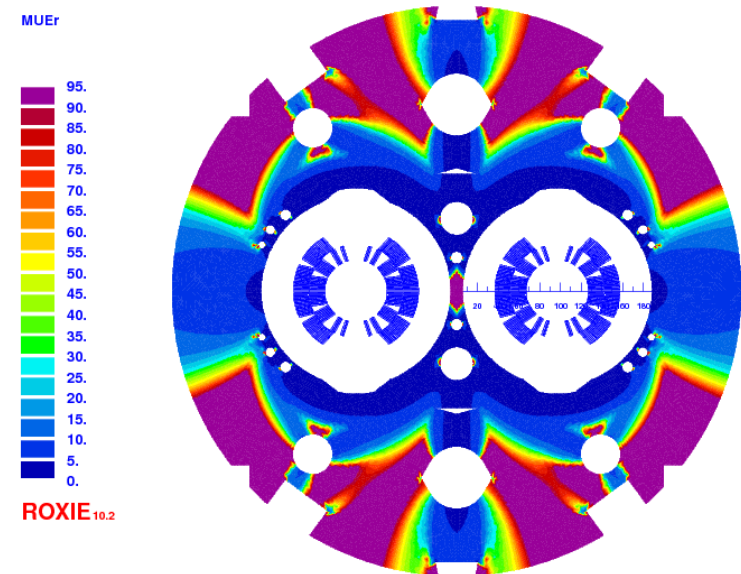

# Towards larger fields

## Nb<sub>3</sub>Sn is limited at 15 T

by E. Todesco

- HTS materials have the amazing feature of having a critical surface with very low slope  $dj/dB$
- Today they are at 300-400 A/mm<sup>2</sup> in the range 15-40 T
  - We just need 20% more and huge spaces will be opened!

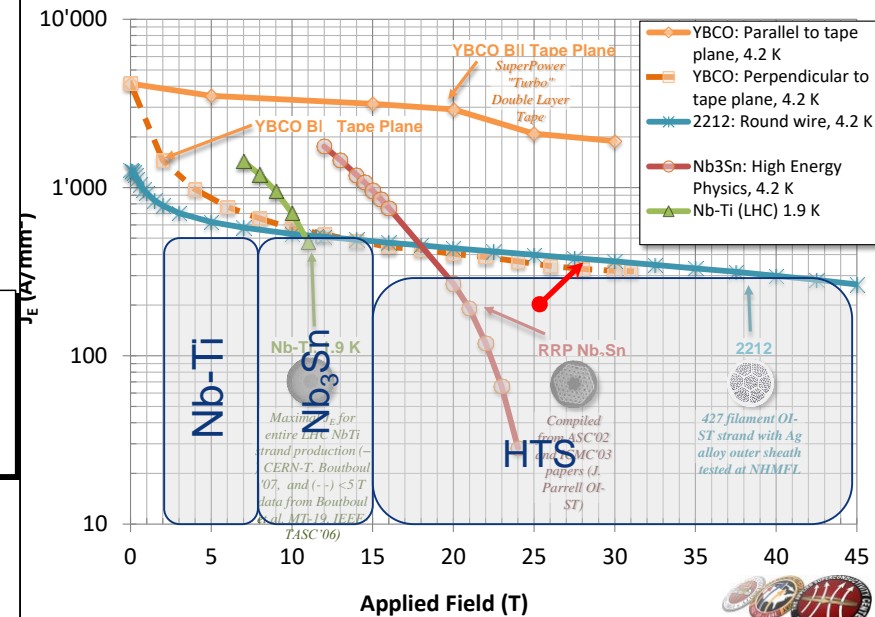
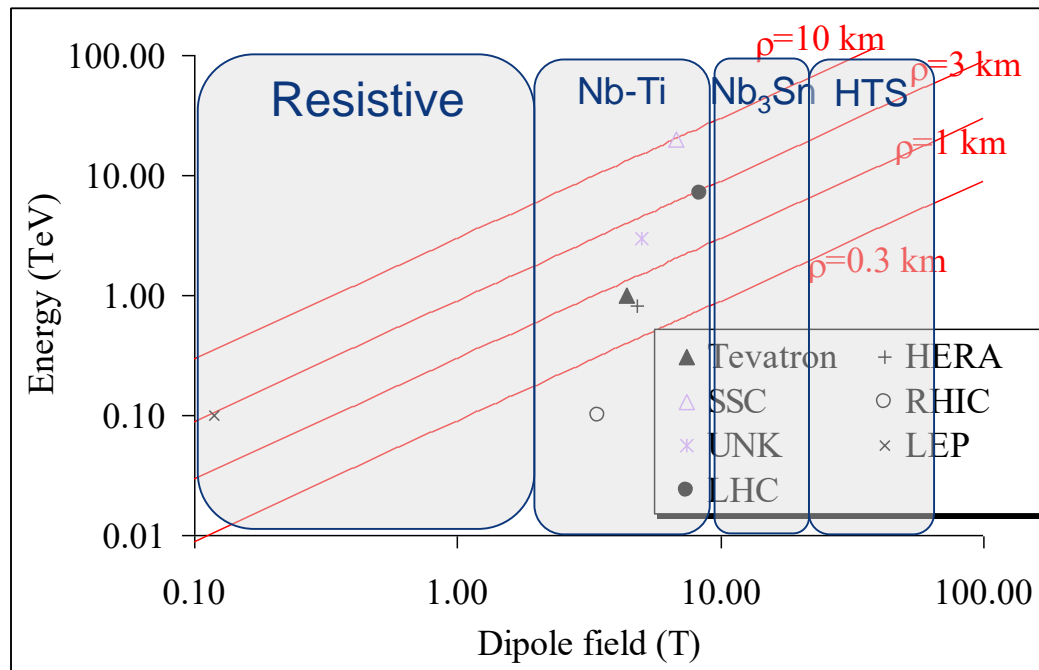

# Beam pipe vacuum

Firstly, these sections make widespread use of a non-evaporable "getter coating" – developed and industrialized at CERN – that absorbs residual molecules when heated. The coating consists of a thin liner of titanium-zirconium-vanadium alloy deposited inside the beam pipes. It acts as a distributed pumping system, effective for removing all gases except methane and the noble gases. These residual gases are removed by the 780 ion pumps.

Secondly, the room-temperature sections allow "bakeout" of all components at 300°C. Bakeout is a procedure in which the vacuum chambers are heated from the outside in order to improve the quality of the vacuum. This operation needs to be performed at regular intervals to keep the vacuum at the desired low pressure.



# CLIC

Novel **two-beam acceleration scheme**: the electrons and positrons of the main beam are propelled to high energy by an additional high current electron beam, the so-called drive beam, that runs parallel to the main beam.

