

Why we need a CMS Upgrade ?

New Technologies to uncover New Physics

Frank Hartmann – CMS Upgrade Coordinator

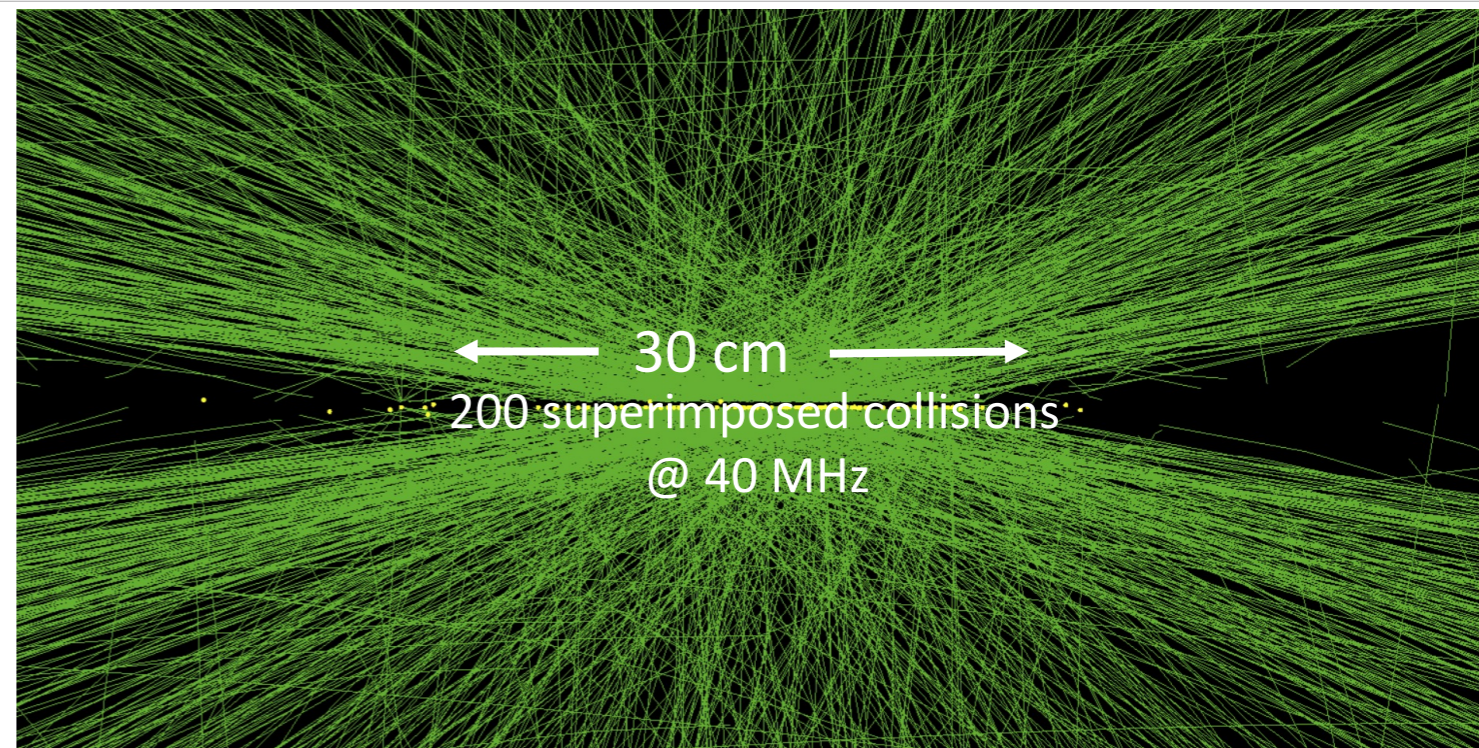
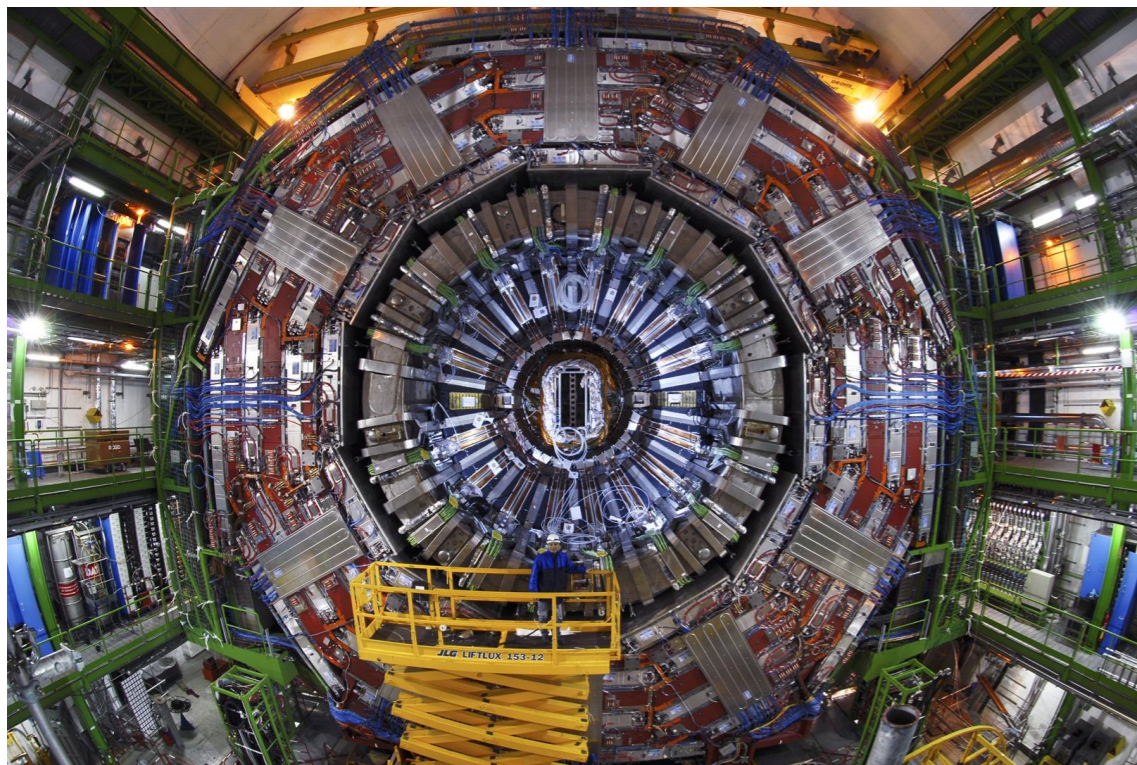

CMS at HL- LHC – In other words ..

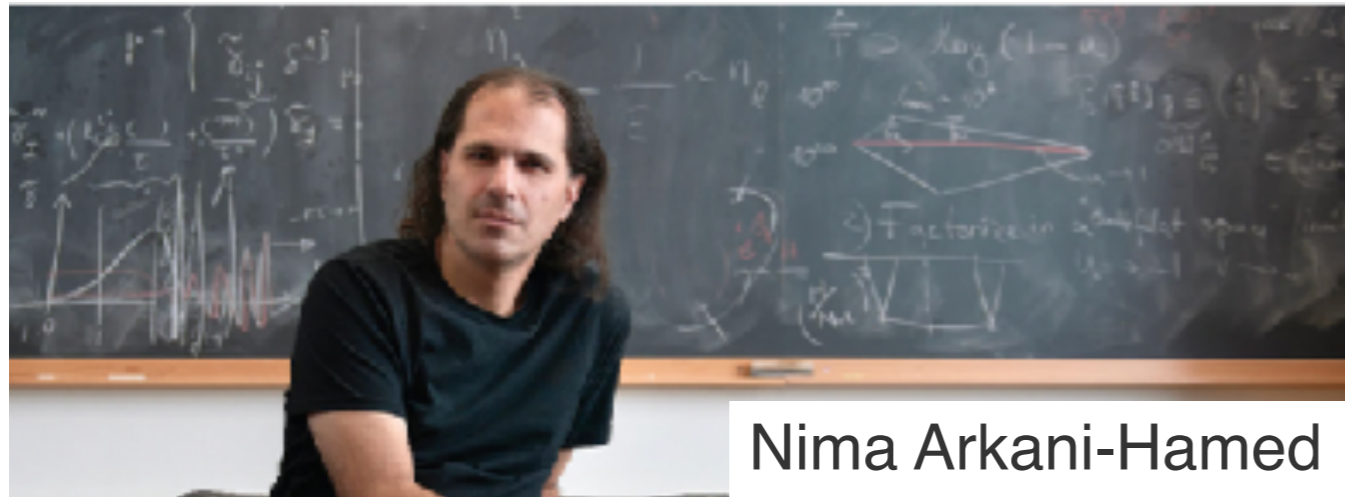

Nima Arkani-Hamed

CERN COURIER | International journal of high-energy physics

Home | About | News | Features | Community | Viewpoint | Reviews | Arc

FEATURE

Interview: In it for the long haul

8 March 2019

“The discovery of the **Higgs particle** – especially with nothing else accompanying it so far – is unlike anything we have seen in any state of nature and is profoundly “new physics” in this sense ... theoretical attempts to compute the vacuum energy and the scale of the Higgs mass pose gigantic, and perhaps interrelated, theoretical challenges. While we continue to scratch our heads as theorists, the most important **path forward for experimentalists is completely clear: measure the hell out of these crazy phenomena!**”

“It is the first example we’ve seen of the simplest possible type of elementary particle. It has no spin, no charge, only mass, and this extreme simplicity makes it theoretically perplexing. ...”

<https://cerncourier.com/in-it-for-the-long-haul/>

The LHC Luminosity Plan

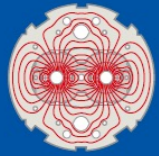

LHC / HL-LHC Plan

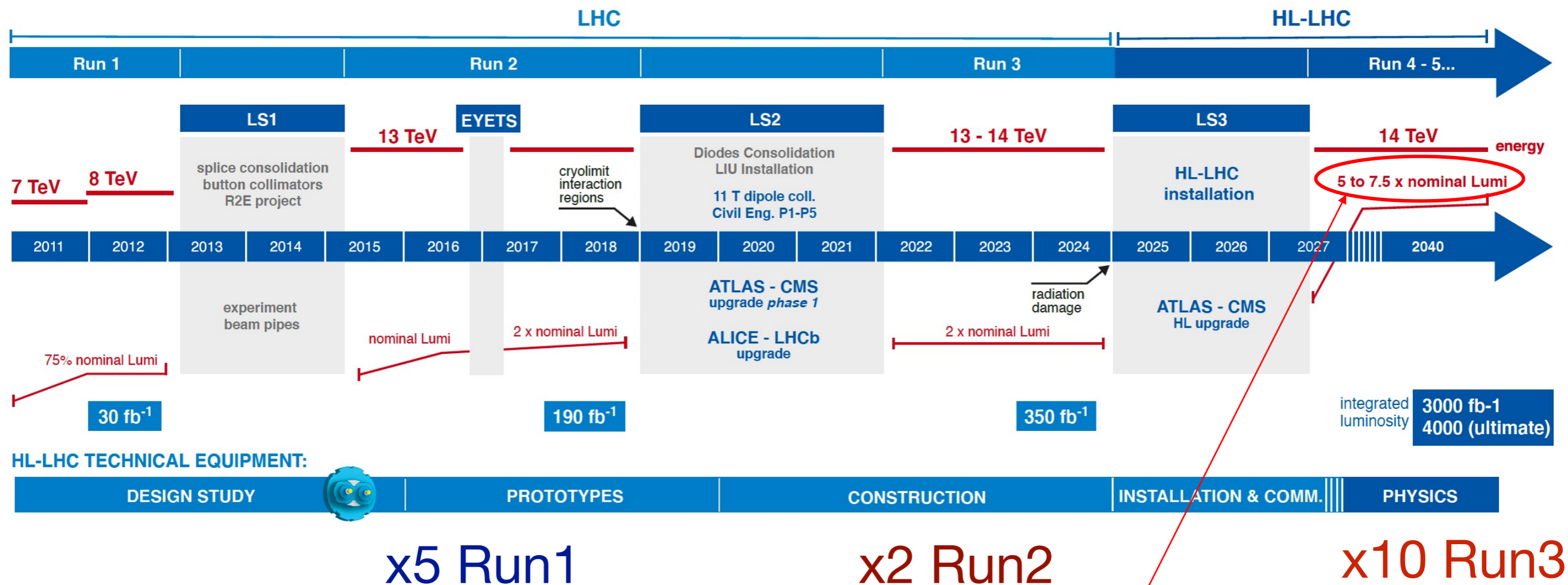

So far LHC has delivered 5% or less of the total planned integrated luminosity!

Notice, this is the Nominal Scenario:
 $L = 5.0 \times 10^{34} \text{ cm}^{-1}\text{s}^{-1}$ up to 3000 fb⁻¹ (140 PU)
The Ultimate Scenario foresees:
 $L = 7.5 \times 10^{34} \text{ cm}^{-1}\text{s}^{-1}$ up to 4000 fb⁻¹ (200 PU)

Raison d'être

- HL-LHC is a Higgs factory, will produce > 150M Higgs bosons
 - Including ~120k of pair produced events
 - Enables a broad program:
 - Precision $O(1-10\%)$ measurements of coupling
 - potential to reveal new, hidden particles in loops
 - Exploration of Higgs potential (**HH** production)
 - Yukawa to 2nd generation, e.g. $H \rightarrow \mu\mu$
 - BSM Higgs searches
 - extra scalars, resonances, exotic decays...
- & New Physics – weak scales - low cross-section
 - Long Lived Particles
 - Special triggers will be challenging
 - Dark Matter
 - Supersymmetry
 - Extra Dimensions
- , and vector boson fusion/scattering
 - Enhance forward region

It's all about high statistics

And better detectors

Dark matter = MET

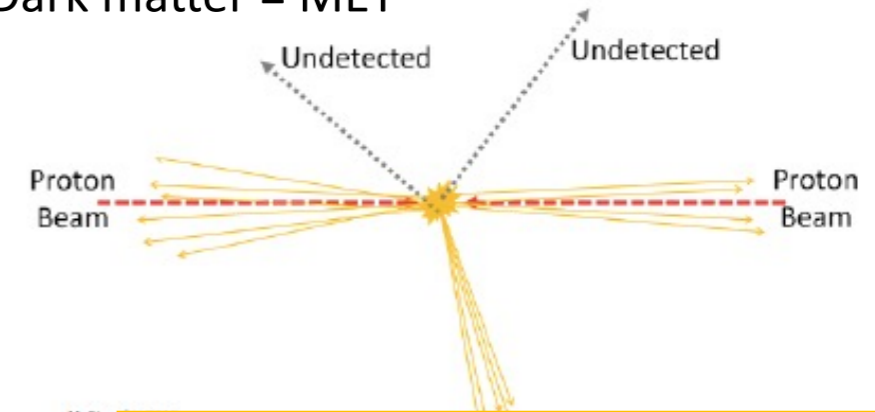

Please, can one of you find DM for me!!

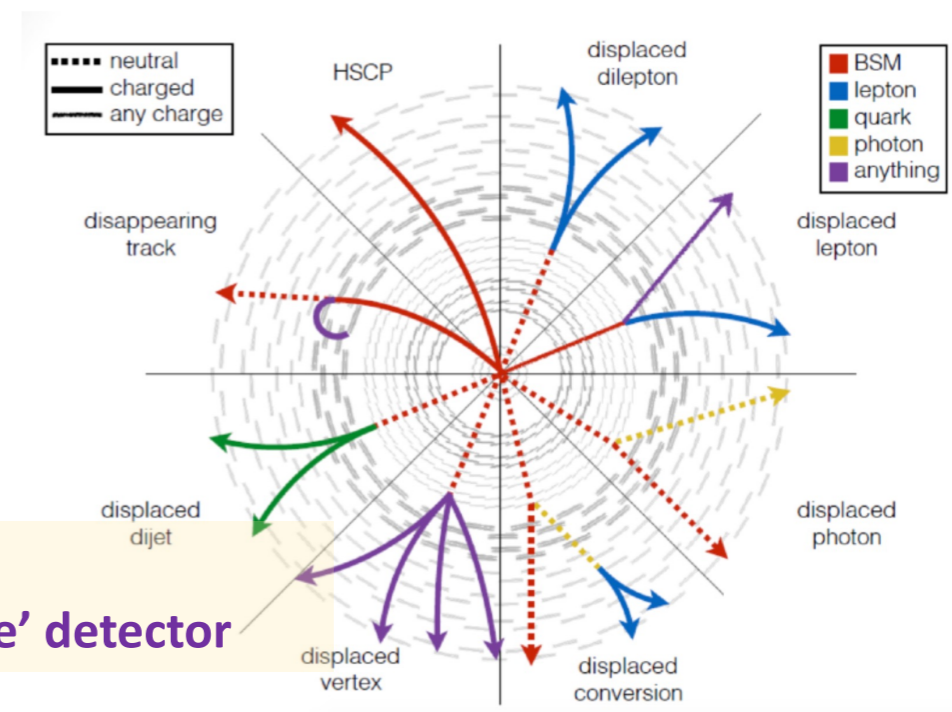

Need precise & 'flexible' detector

= Endless opportunities (studies, hardware, etc.)

This time, we're after Higgs-Pairs (di-Higgs)

H → γγ discovery in Run1

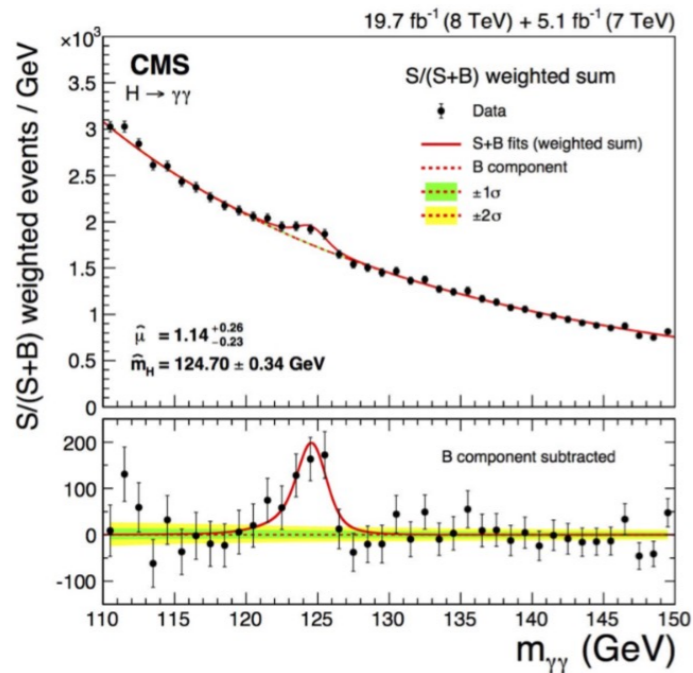

H(bb)H(γγ) evidence @ HL-LHC

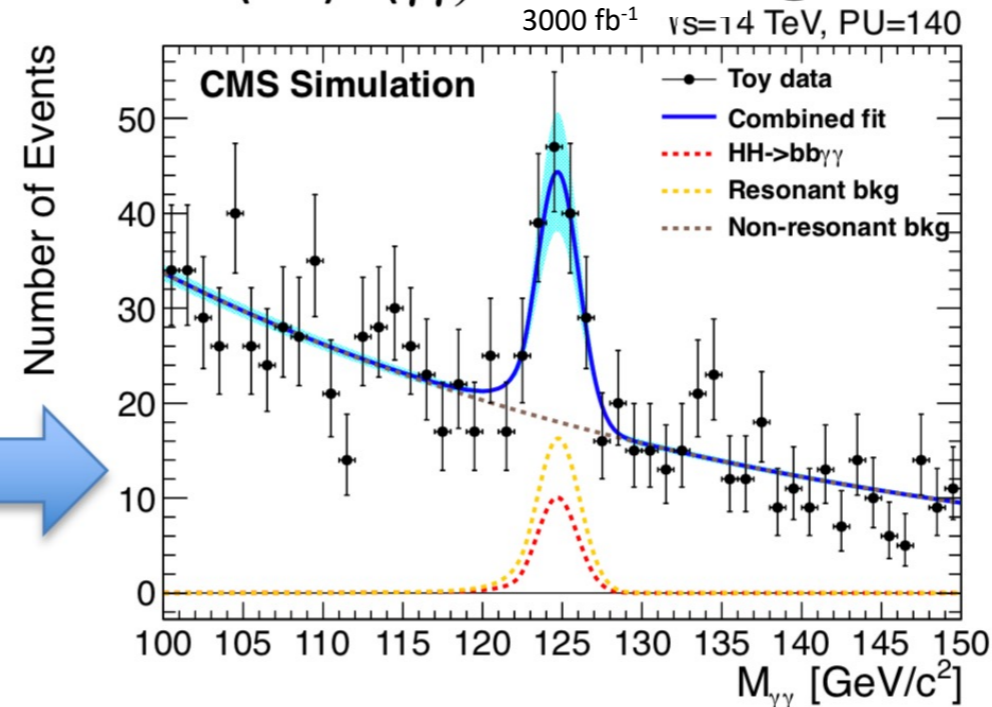

CERN-LHCC-2015-10 LHCC-P-008 CMS-TDR-15-02

Channel	Significance	
	Stat. + syst.	Stat. only
bbbb	0.95	1.2
bbττ	1.4	1.6
bbWW(lνlν)	0.56	0.59
bbγγ	1.8	1.8
bbZZ(llll)	0.37	0.37
Combination	2.6	2.8

Higgs self-interaction

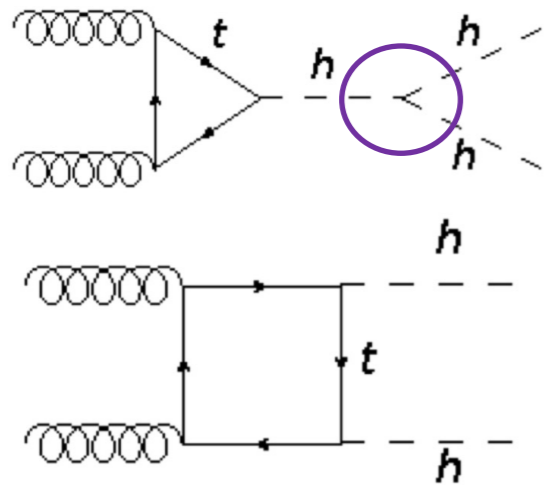

New tracker: **+15%** efficiency per *b*
 HGICAL: **+10%** efficiency per γ
 Muon: **+17%** efficiency μ
 Timing: another **+6 - 20%** (comb.)

Statistically **bbγγ** seems the most promising channel

Combined with ATLAS, **4σ** might be possible (3000fb⁻¹)

NB.: 20 years to achieve HH with $\sim 3 \sigma$ with CMS

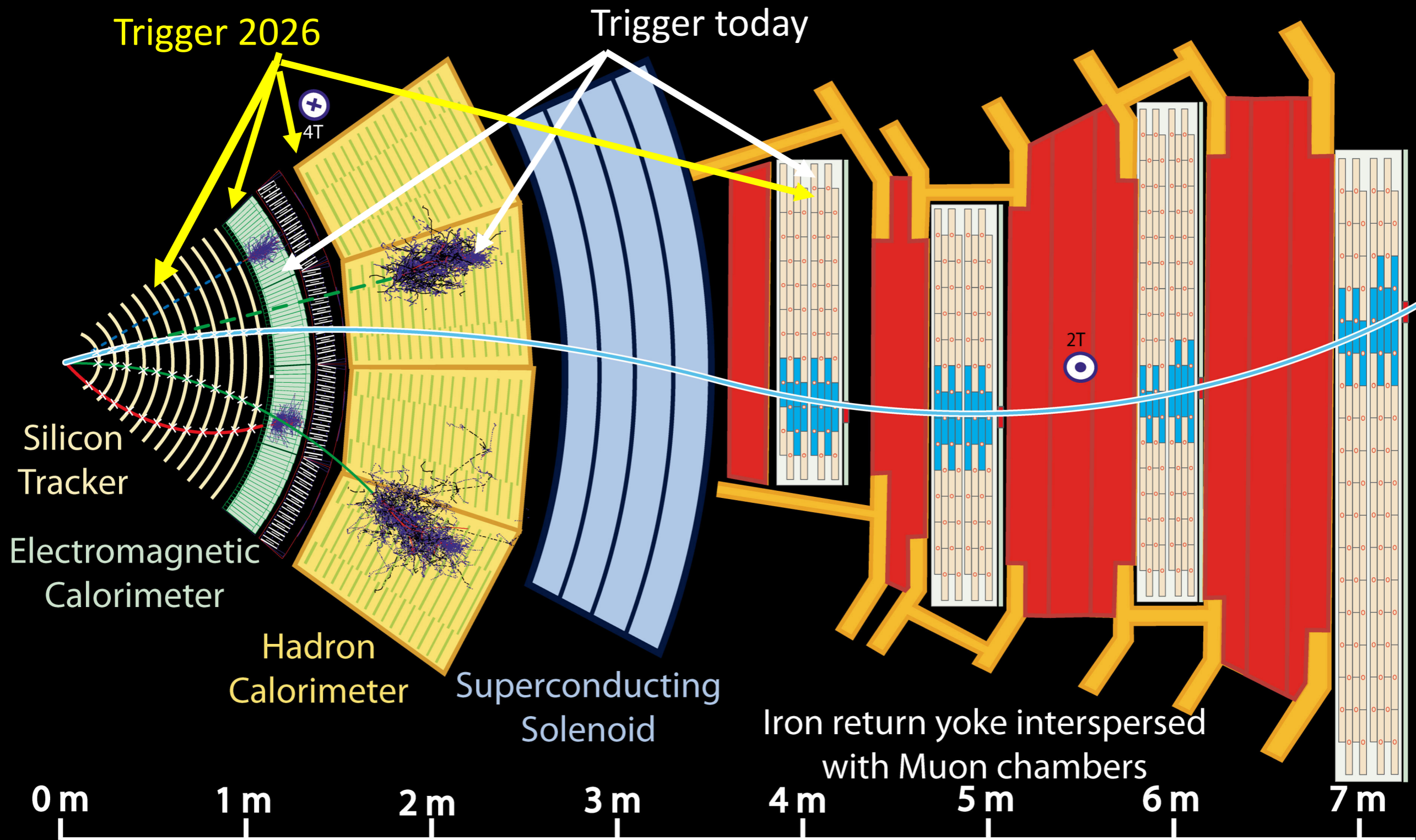

Key:

— Muon

— Electron

— Charged Hadron (e.g. Pion)

- - - Neutral Hadron (e.g. Neutron)

- - - Photon

Detectors interleaved with the magnet yoke steel layers

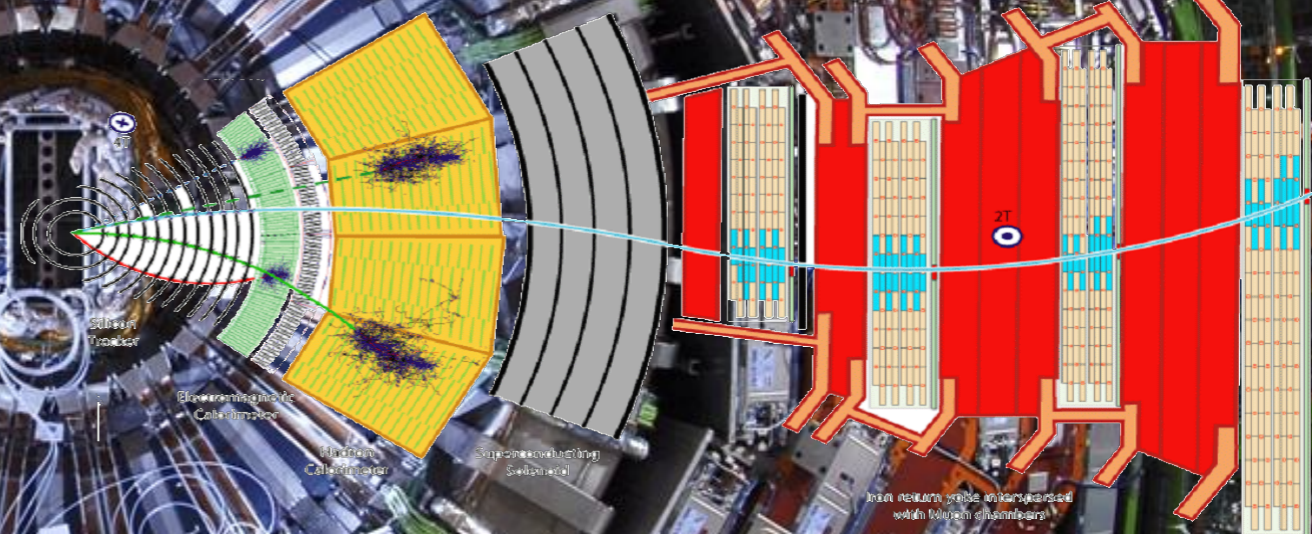
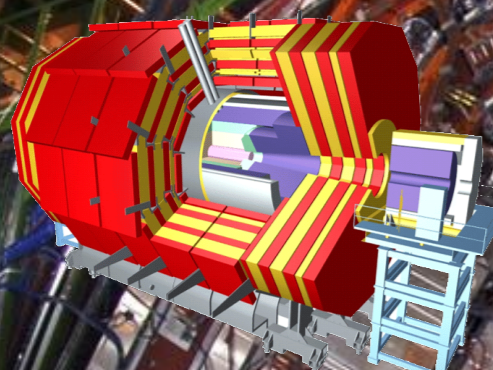



2016

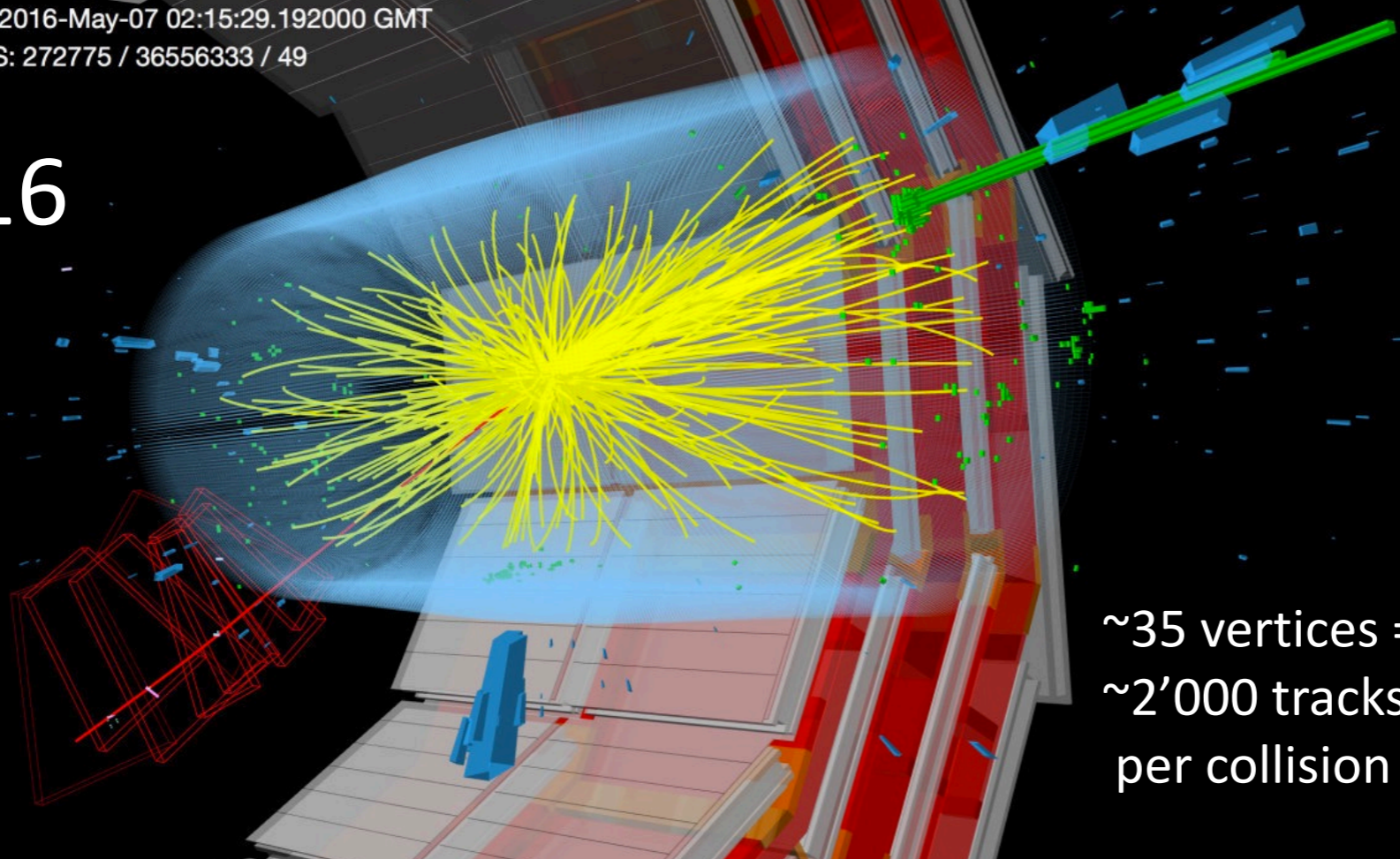

~35 vertices = 40 collisions = pile-up
~2'000 tracks
per collision bunch (40MHz)

2026

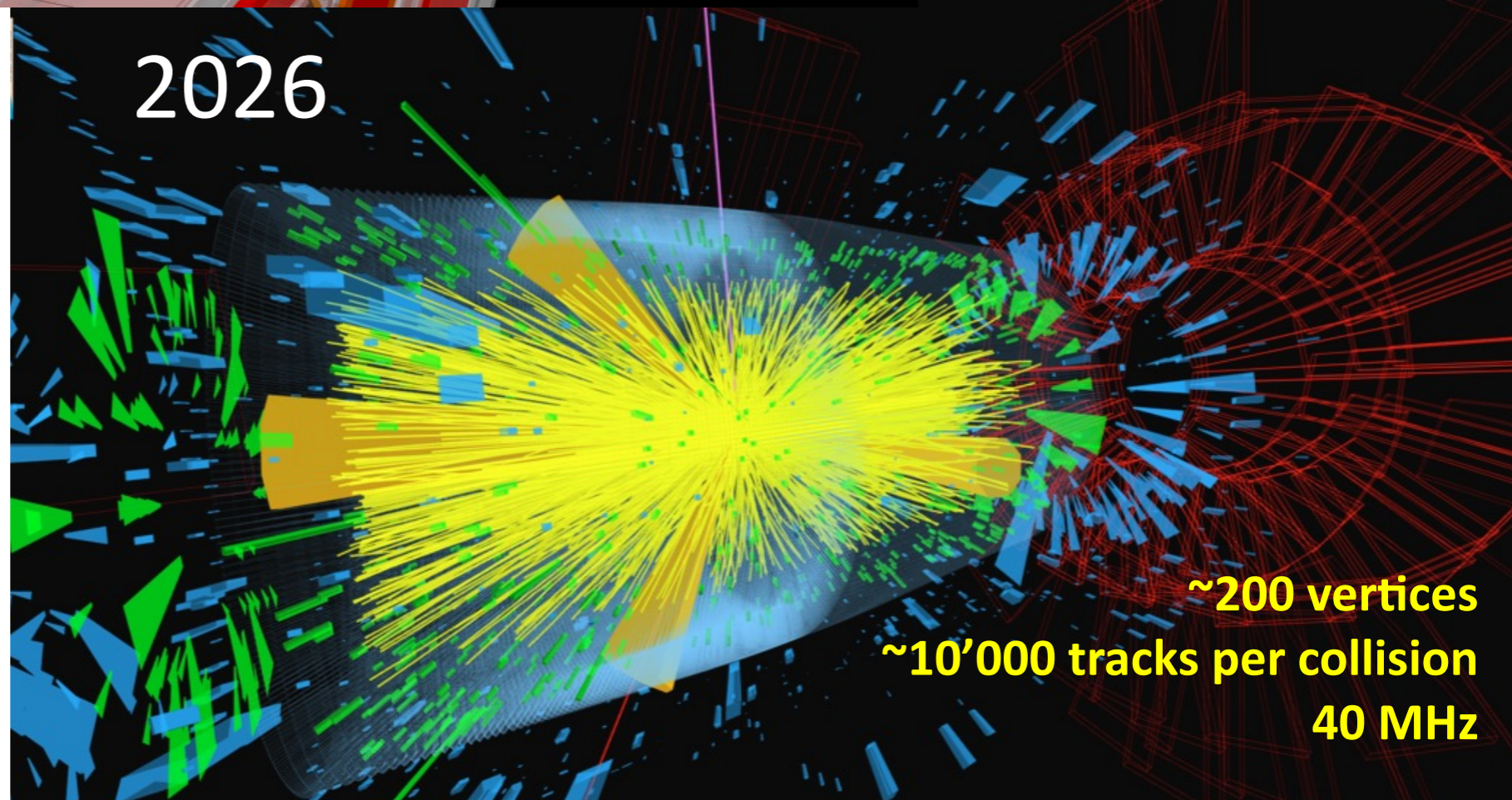

~200 vertices
~10'000 tracks per collision
40 MHz

Bottlenecks

Radiation tolerance improvement
(*silicon sensors*)

Channel granularity
Silicon, GEM

Increase coverage
(mostly eta)

- **Replace (most of) the electronics**
 - Increase bandwidth
- **New Tracker (incl. trigger)**
- **New high granularity endcap CALO**
- **Extend Muon in forward direction**
- **Add Timing Detector (*mitigate pile-up*)**
 - **Add timing in Muon and calorimeter**

- L1 Trigger latency (storage on FE chip)
 - ECAL $3.8\mu\text{s} \rightarrow$ streaming
 - TK $6.4\mu\text{s} \rightarrow 12.5\mu\text{s}$
- L1 Trigger rate
 - $100\text{kHz} \rightarrow 750\text{kHz}$

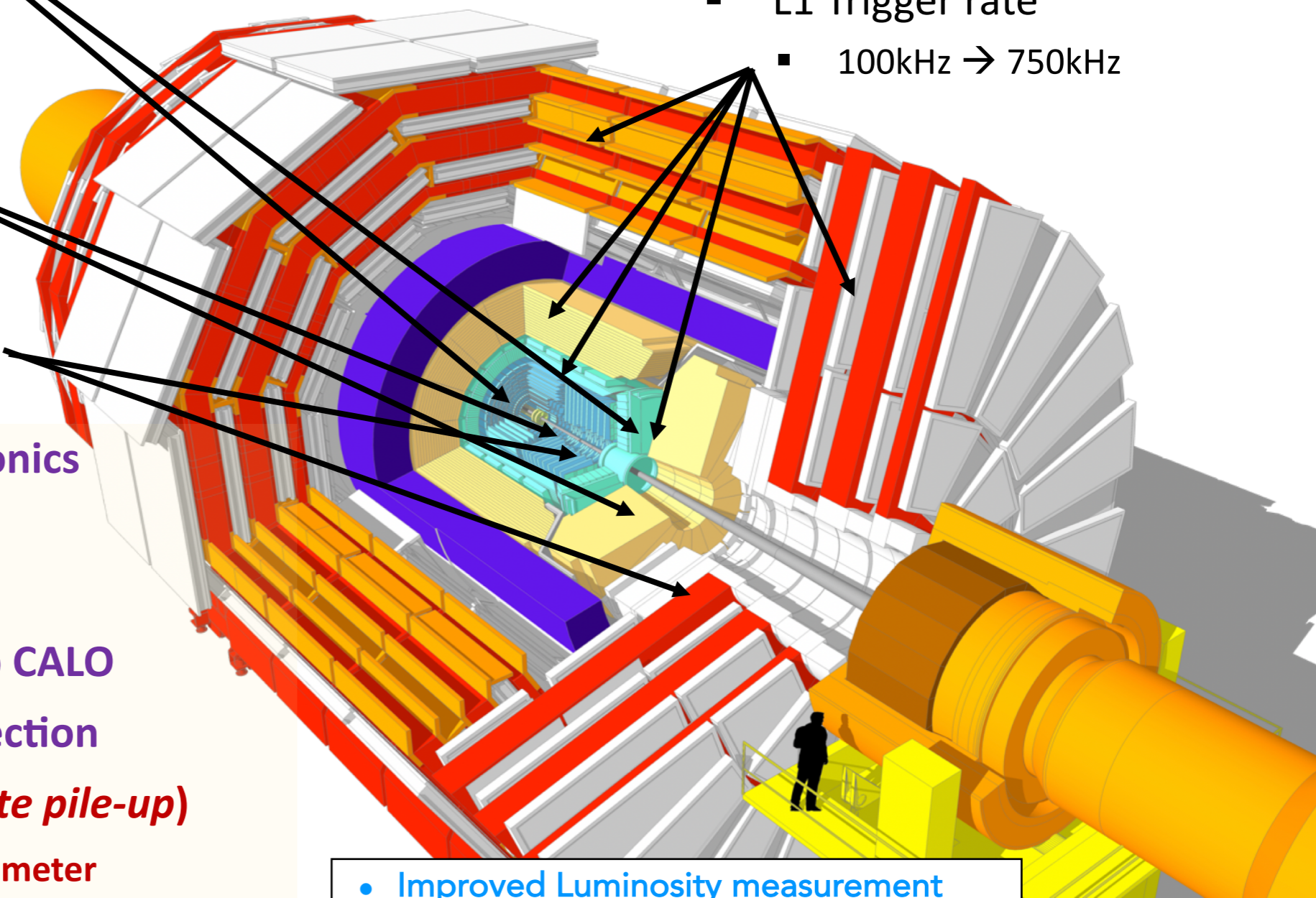

- Improved Luminosity measurement
 - $< 1\%$ offline (Lumi POG)
 - $< 2\%$ online

On the technology aspect

From our external reviewers:

“We want to note (again) that these projects are unprecedented in scale in particle physics, shift various paradigms, and employ technologies that have never before been exercised by the field.”

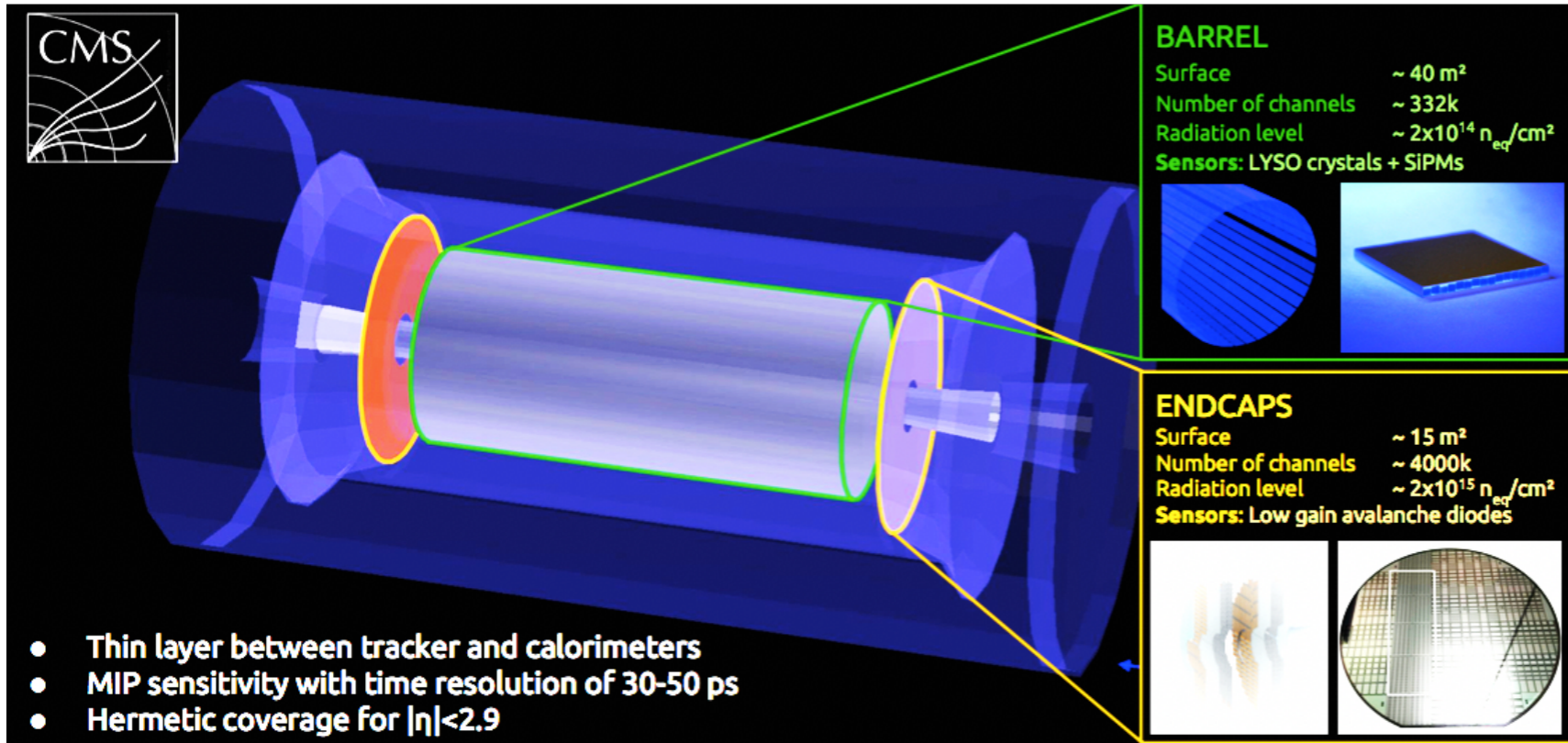

Between Tracker and Calorimeter

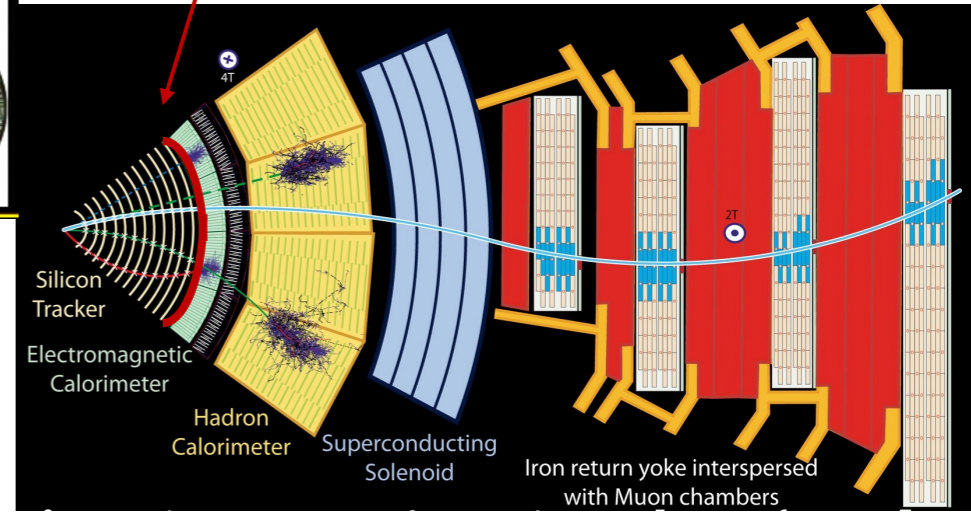

30 ps timing – the extra independent parameter makes the difference

MTD MIP Timing Detector

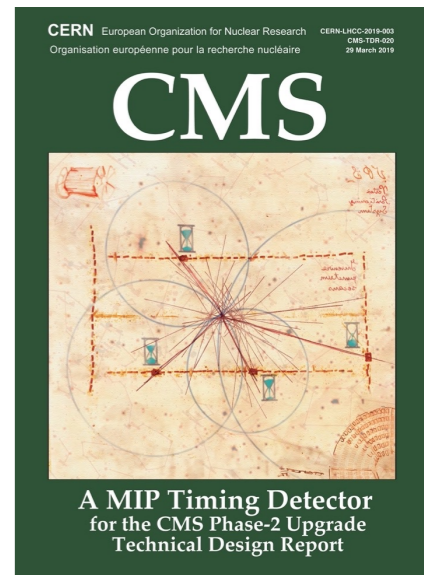

Sorting the mess even better

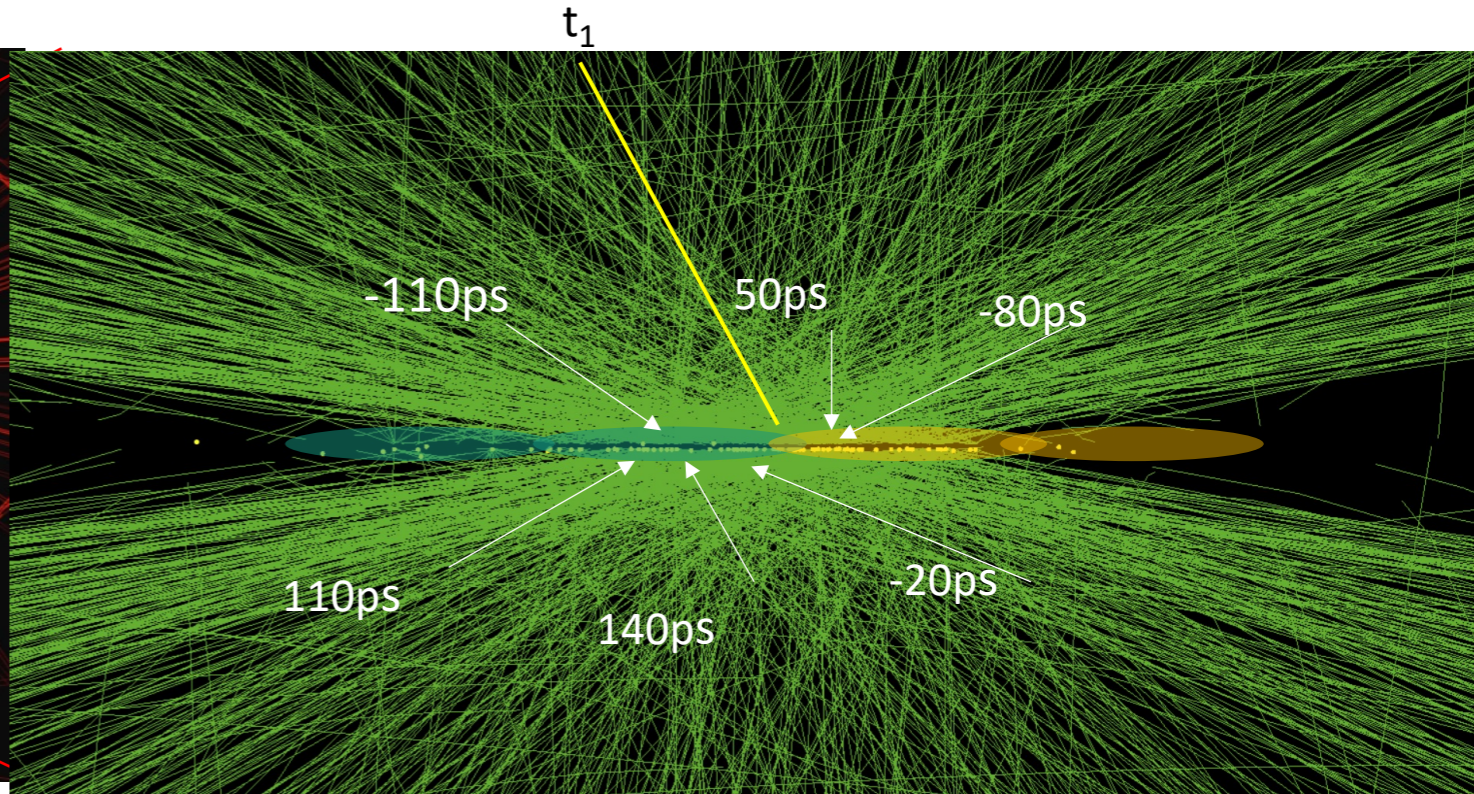
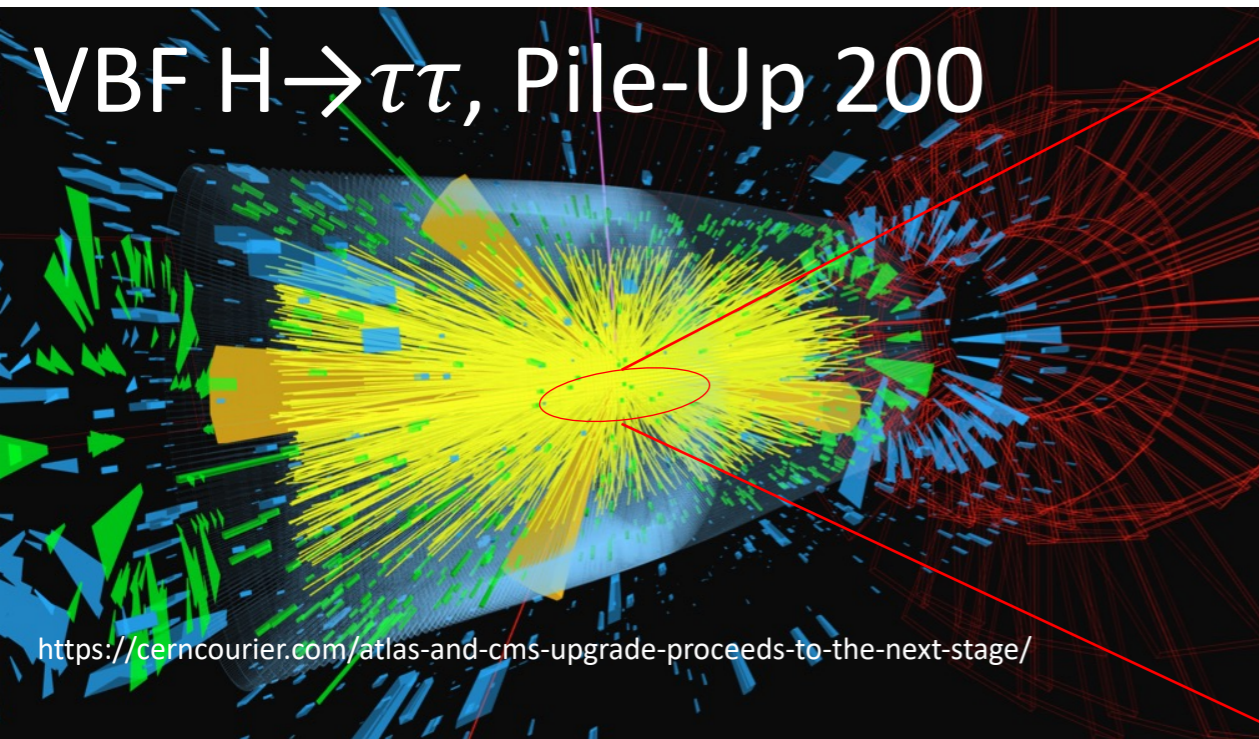

○ 200 pileup collisions

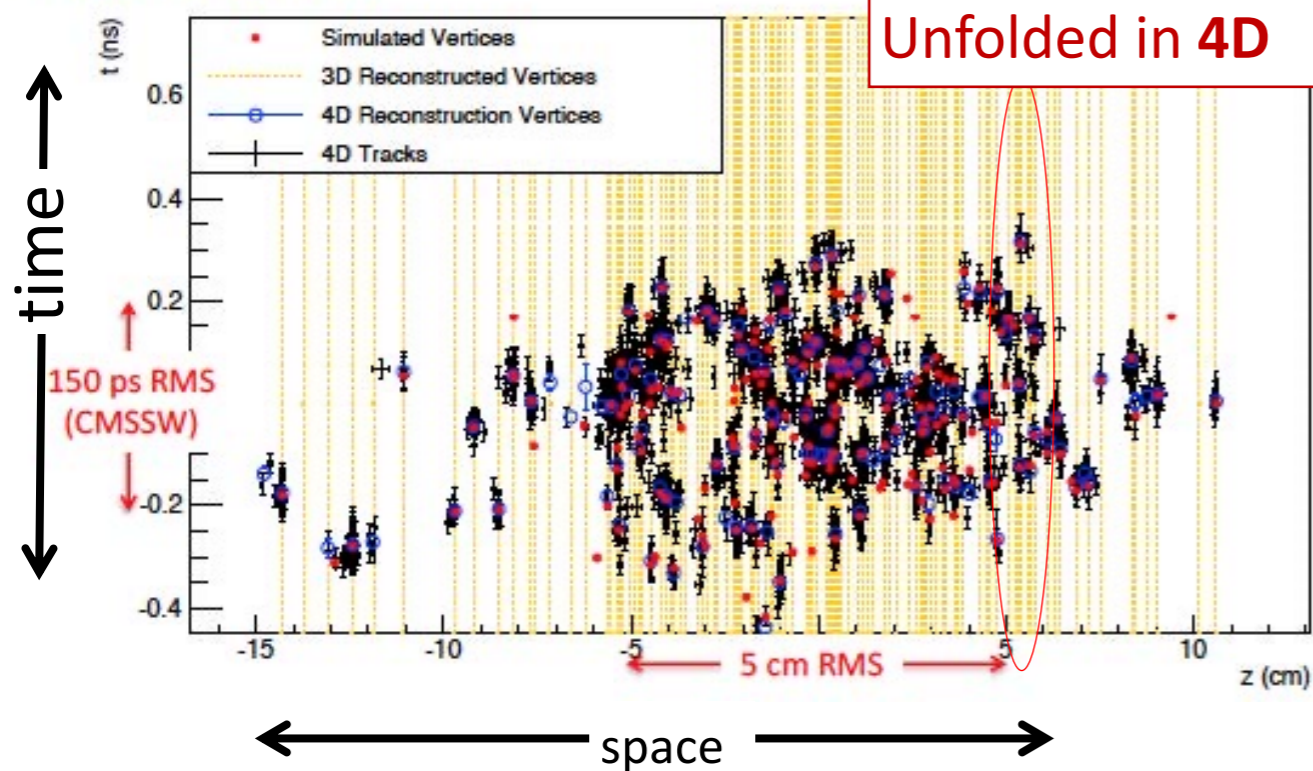

Ambiguous in 3D space
Unfolded in 4D

~10'000 tracks
per collision bunch

- @ PU=200
Vertex density ~ 1 vertex/mm
- A 30 ps resolution (y axis \leftarrow plot) allows to resolve vertices at the same z
- “you get close to a Run-2 PU situation”

Ups, What is this?

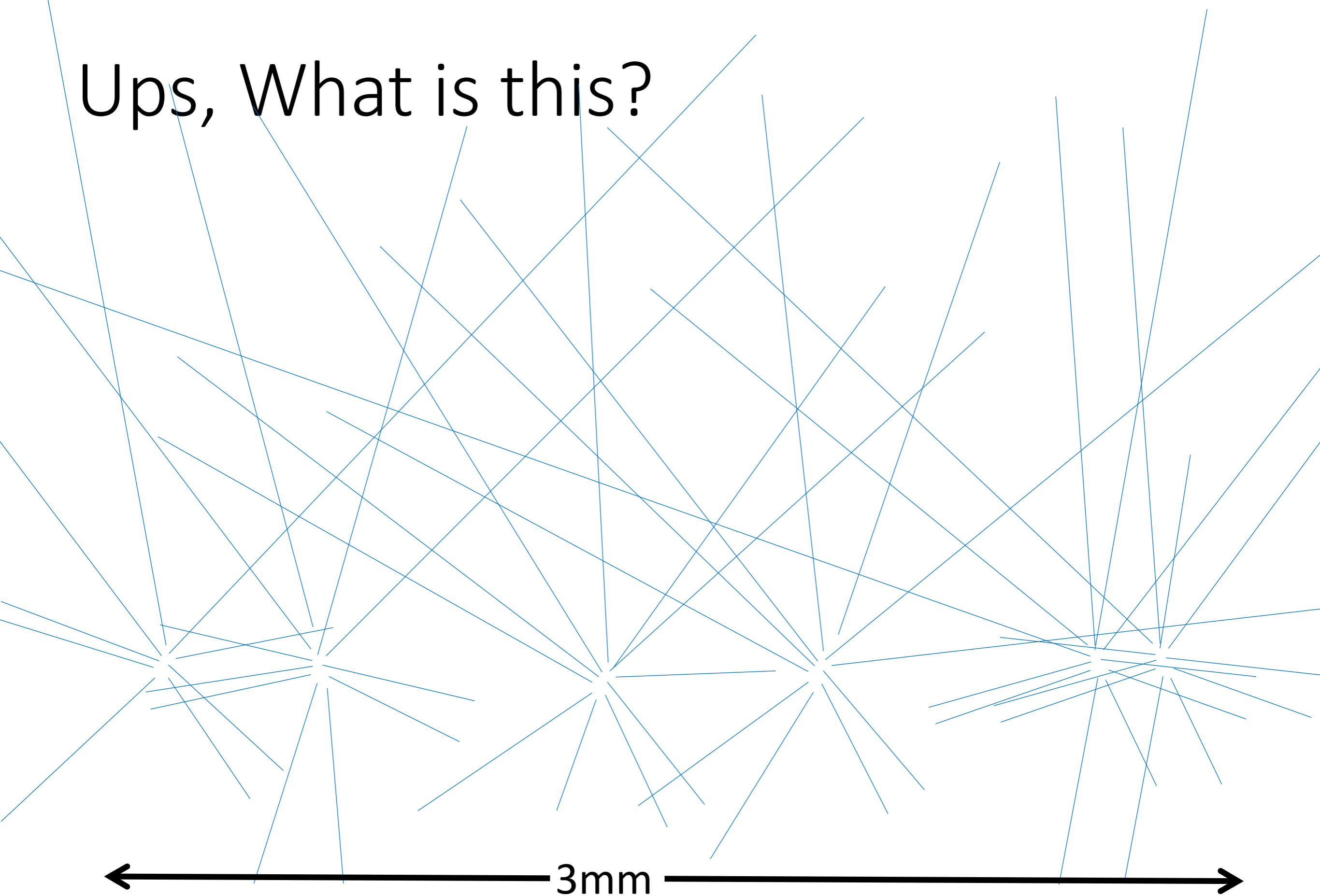

Pile-up of vertices = mess

Better?

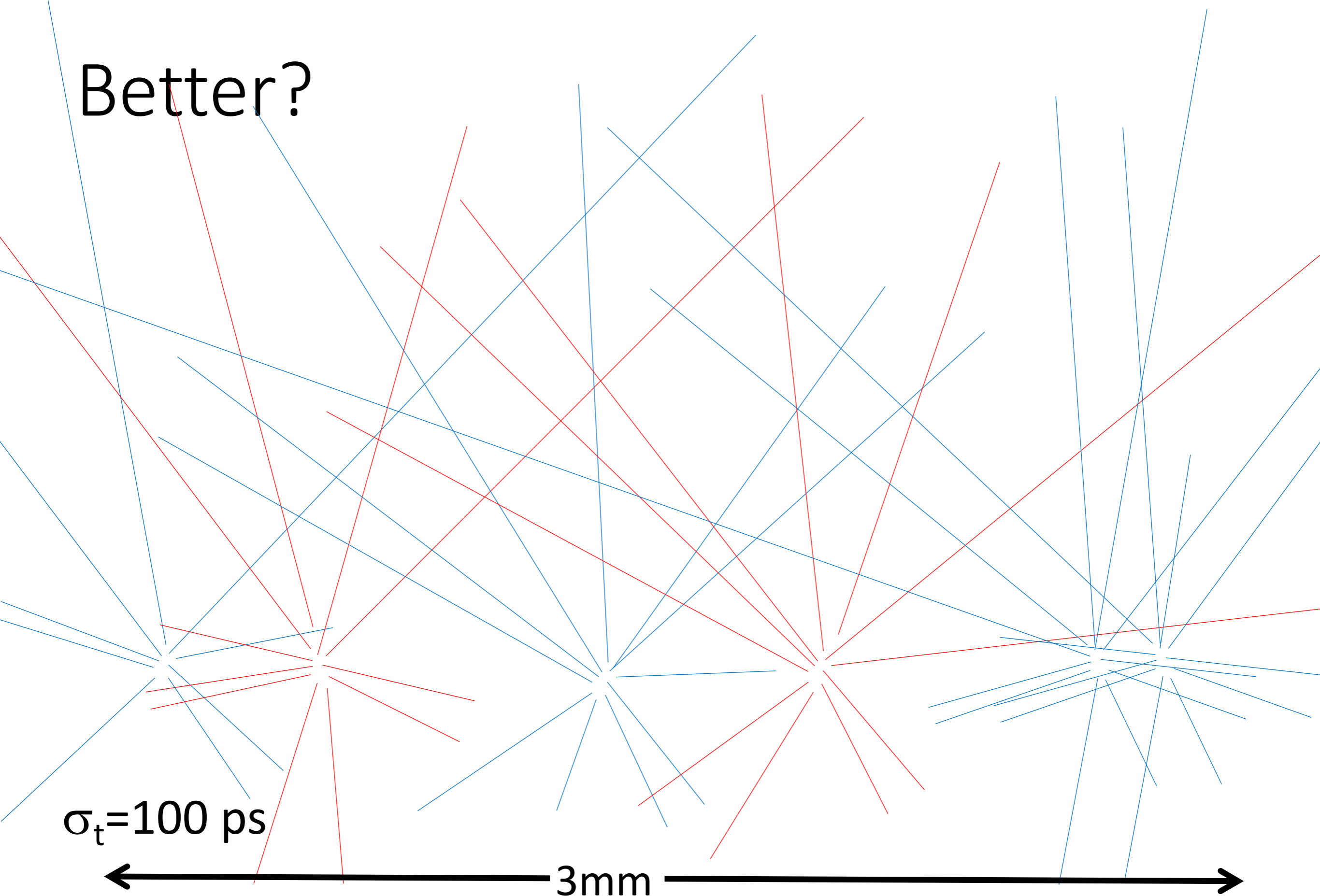

Much better

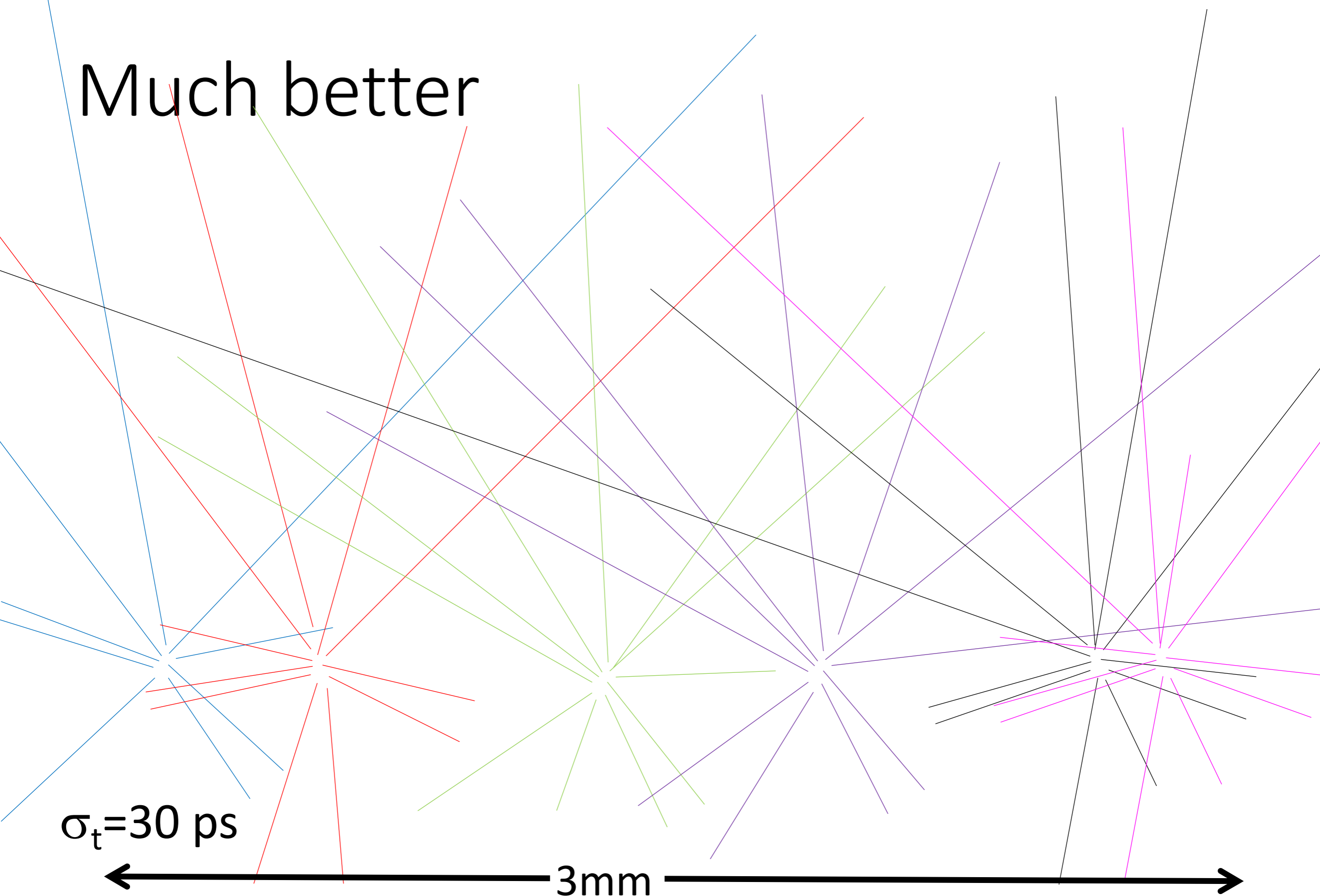

The Muon Detectors

Involvement of IPM

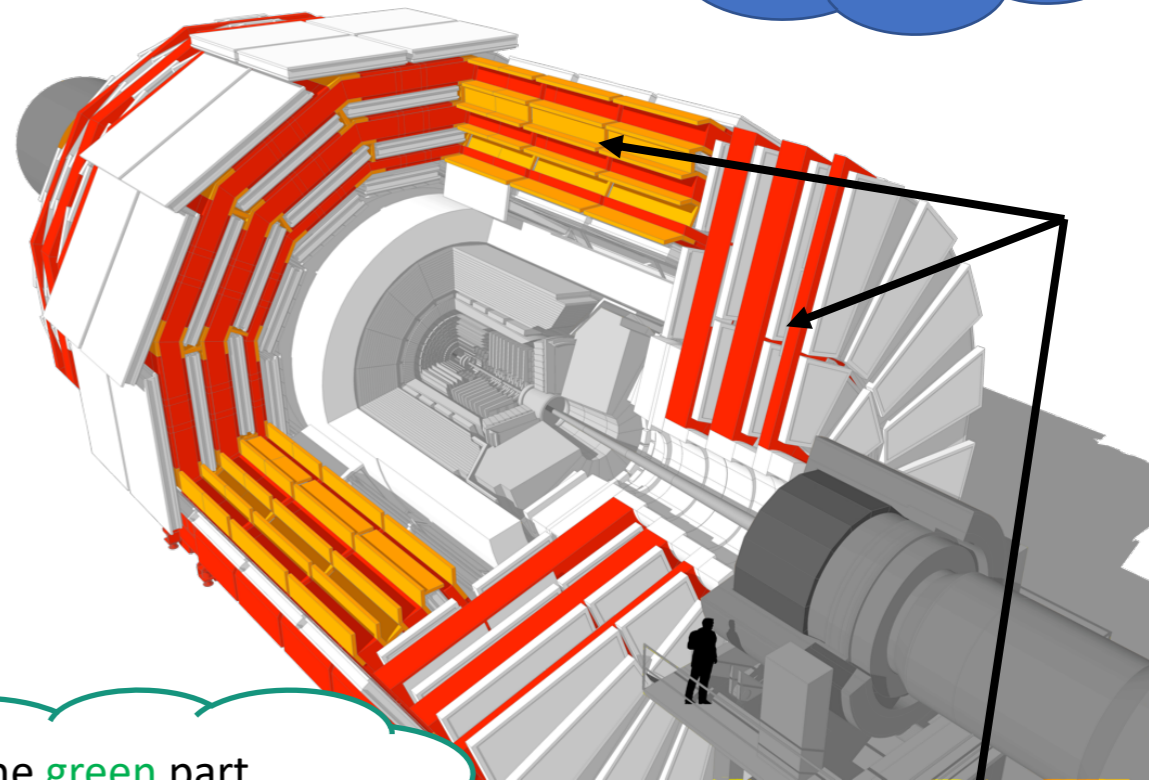
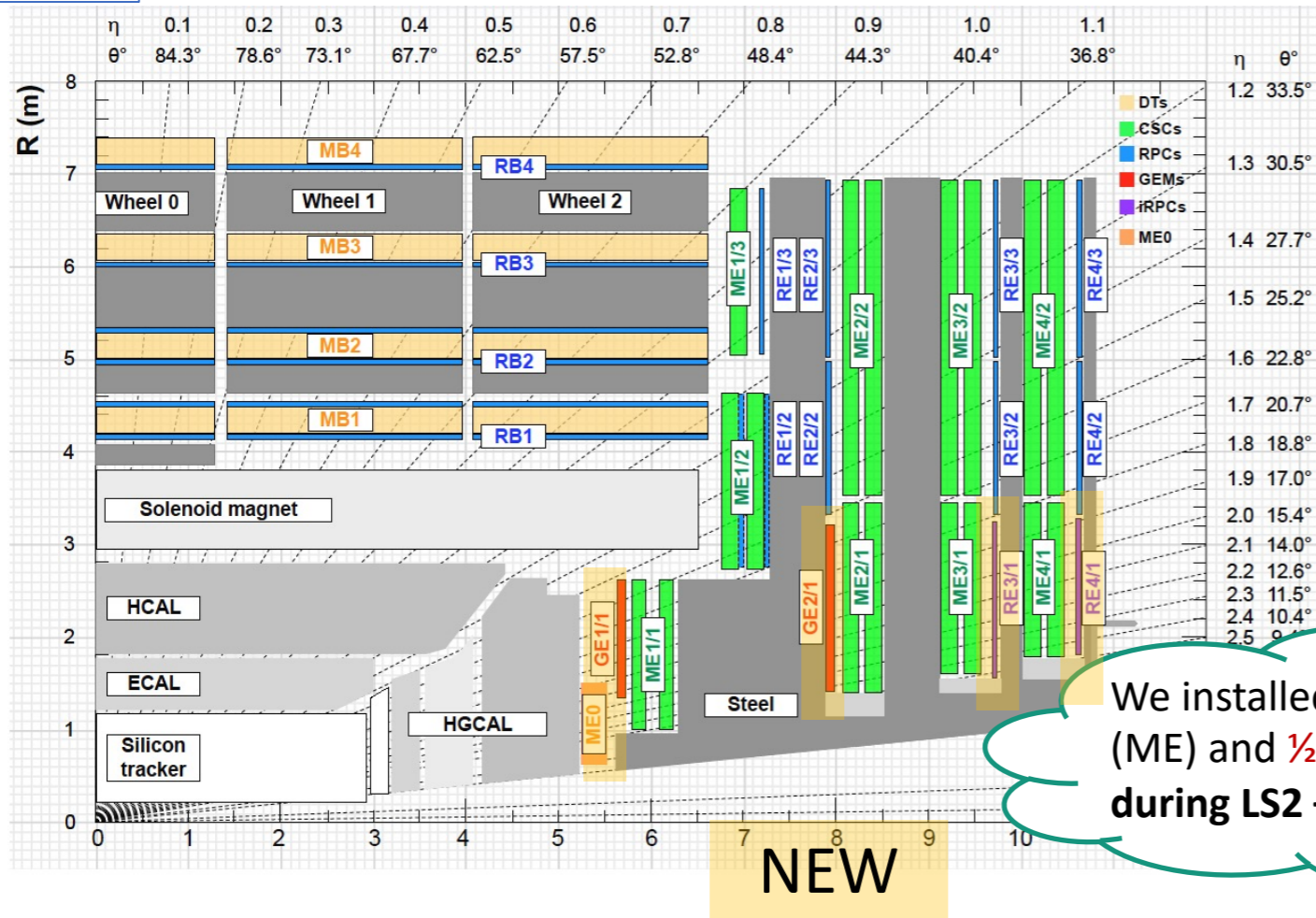

We installed the green part (ME) and 1/2 the red (GE1/1) during LS2 – done!

- **New electronics everywhere to cope with 10-fold rates**
 - Extract many, many chambers and re-install
- Add new detectors in very-forward region
 - **New technologies (Gas Electron Multiplier GEM)**
 - Better resolution; much higher rates (MHz/cm²)
- **Install most, long before LS3 !**

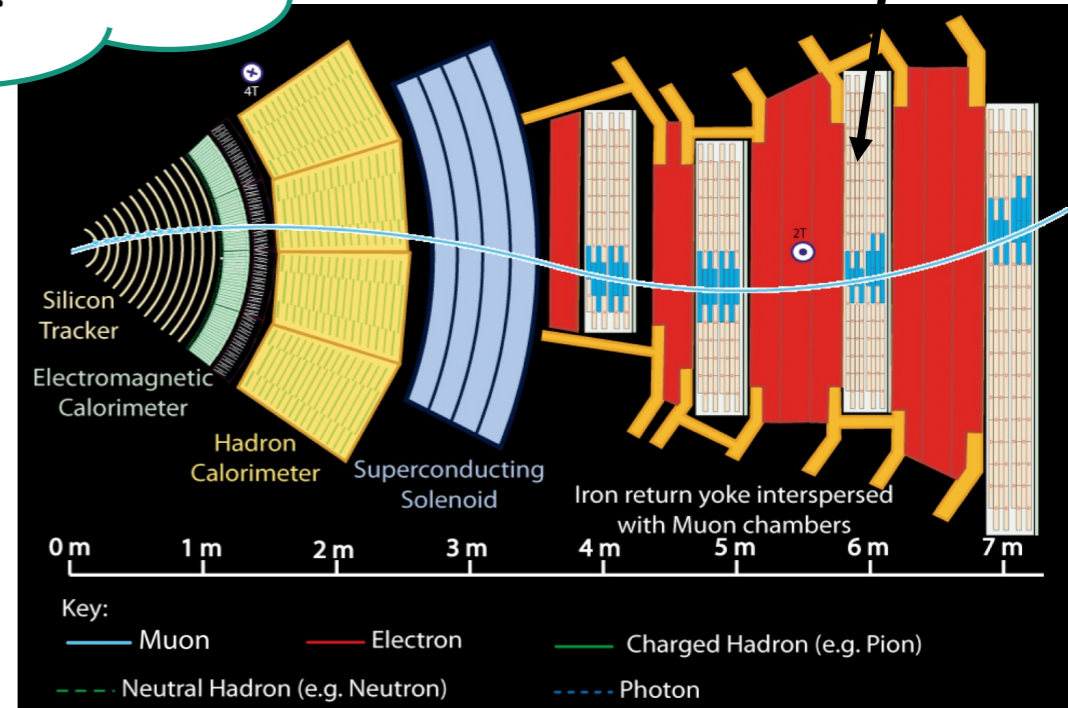

Spike my Muons performance

- New GEM detector
 - Extension in $2.4 < |\eta| < 2.8$
 - Much better resolution
 - Much better rate capability

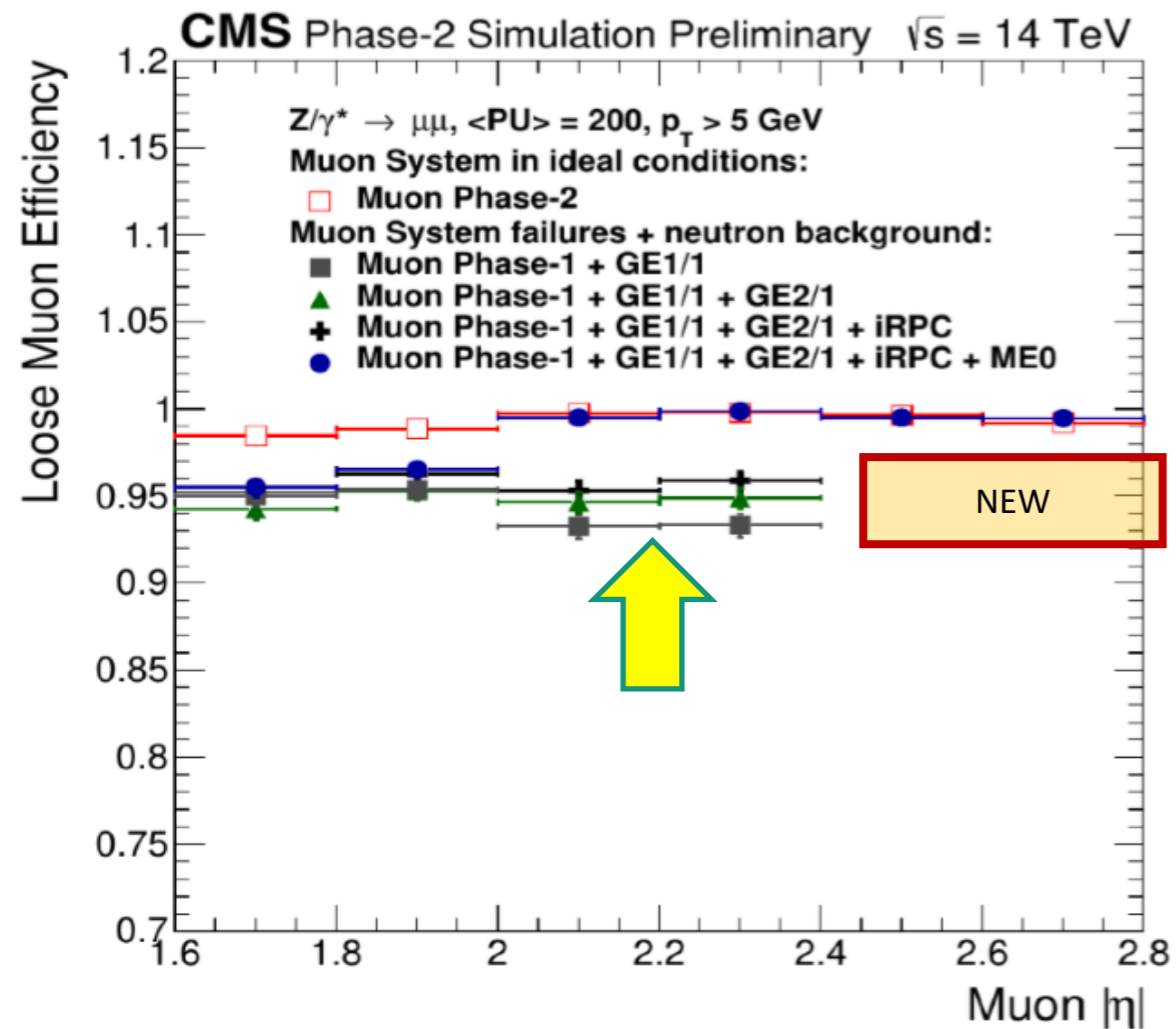
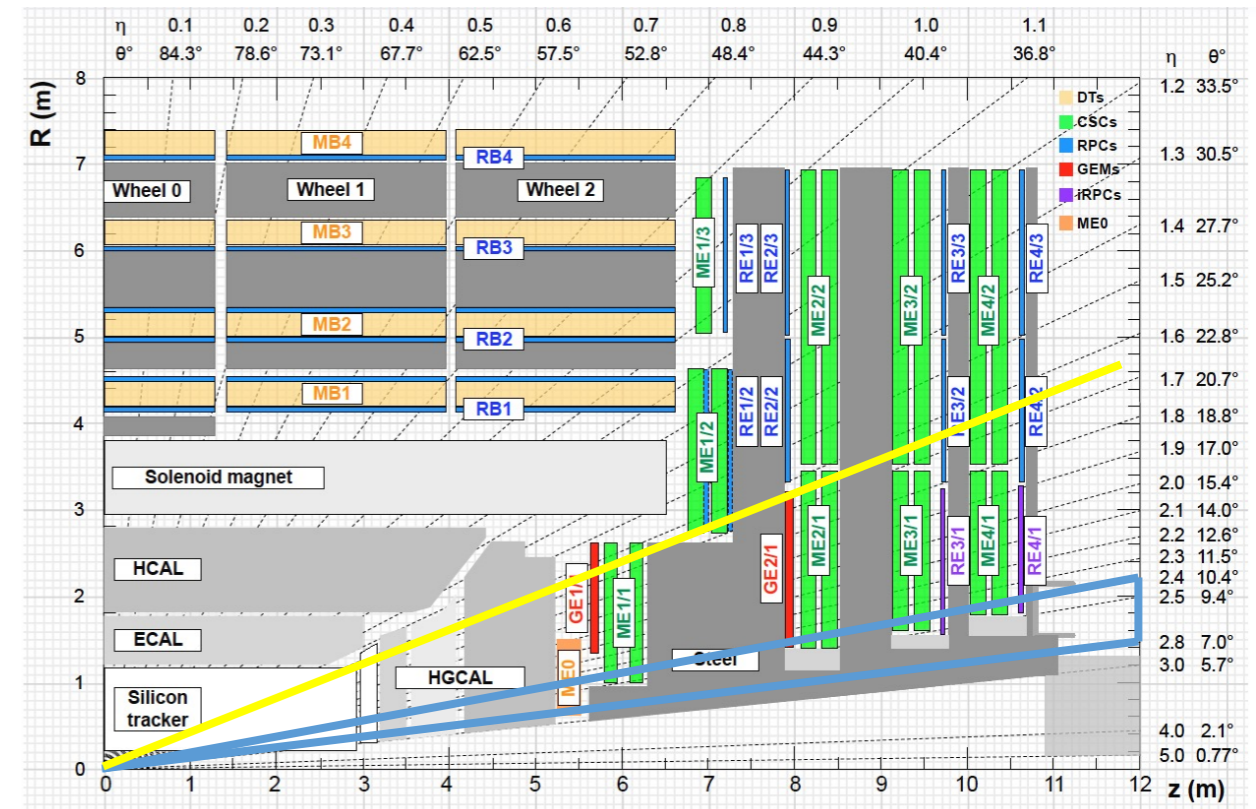

Higgs into 4 leptons:
acceptance increase $\sim 17\%$

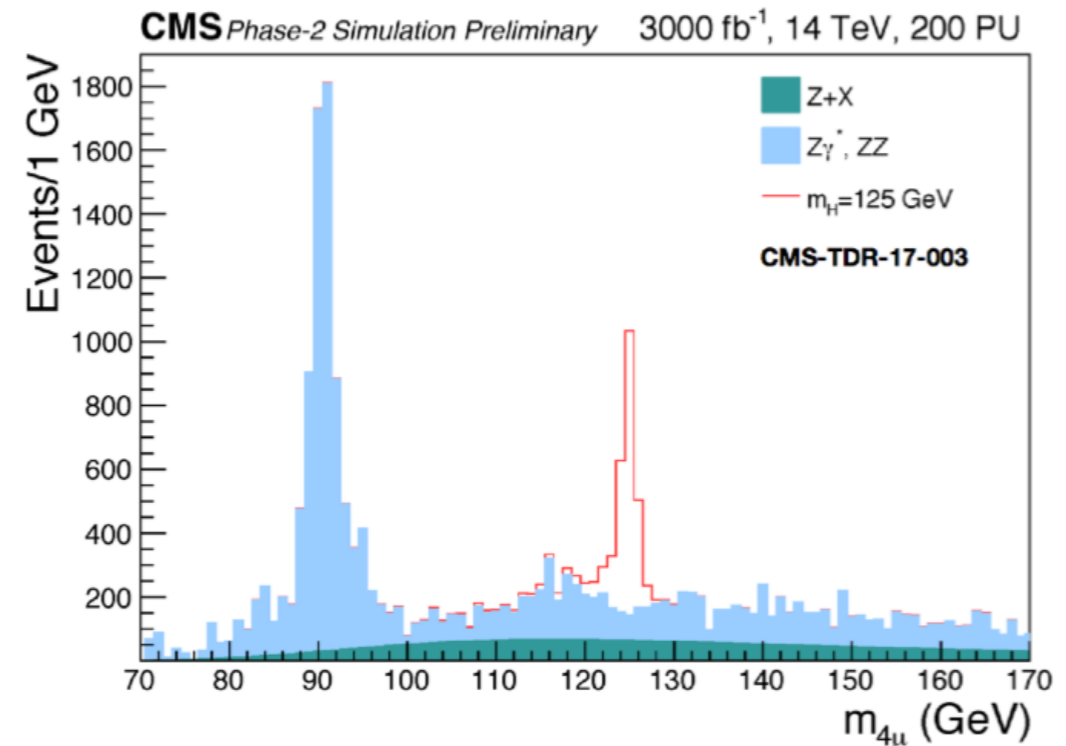

Wonderful new opportunities with the new Muon system

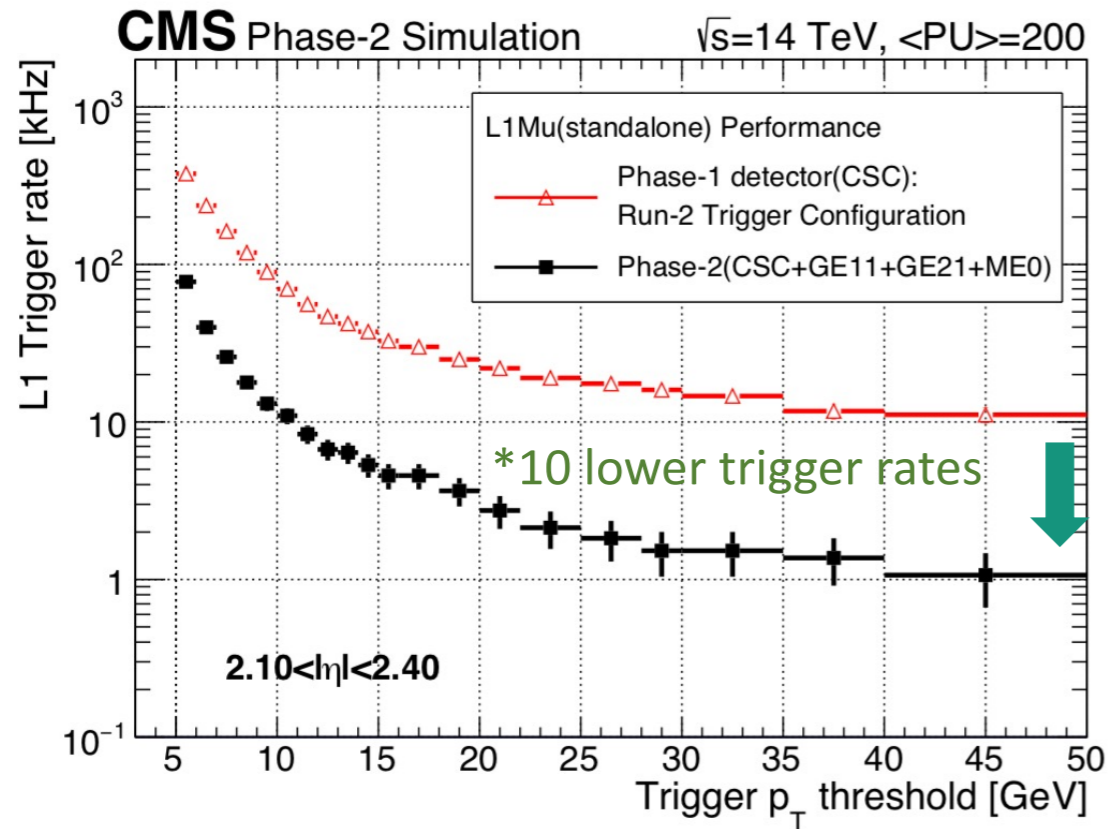
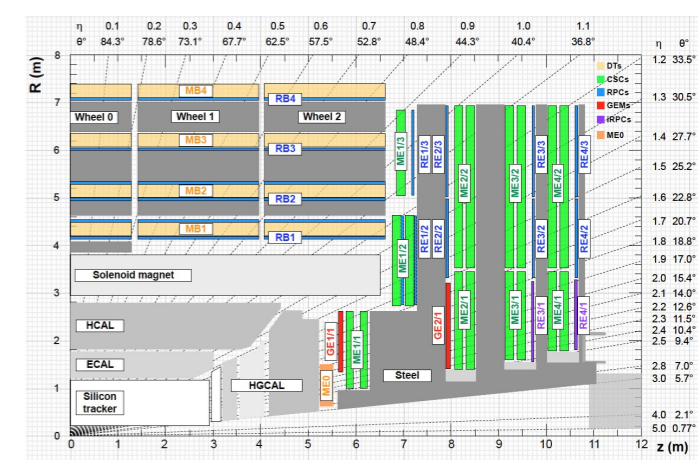

RPC-2 time resolution 1ns (today 25ns)
Identify 'slow' Heavy Stable Charged Particle

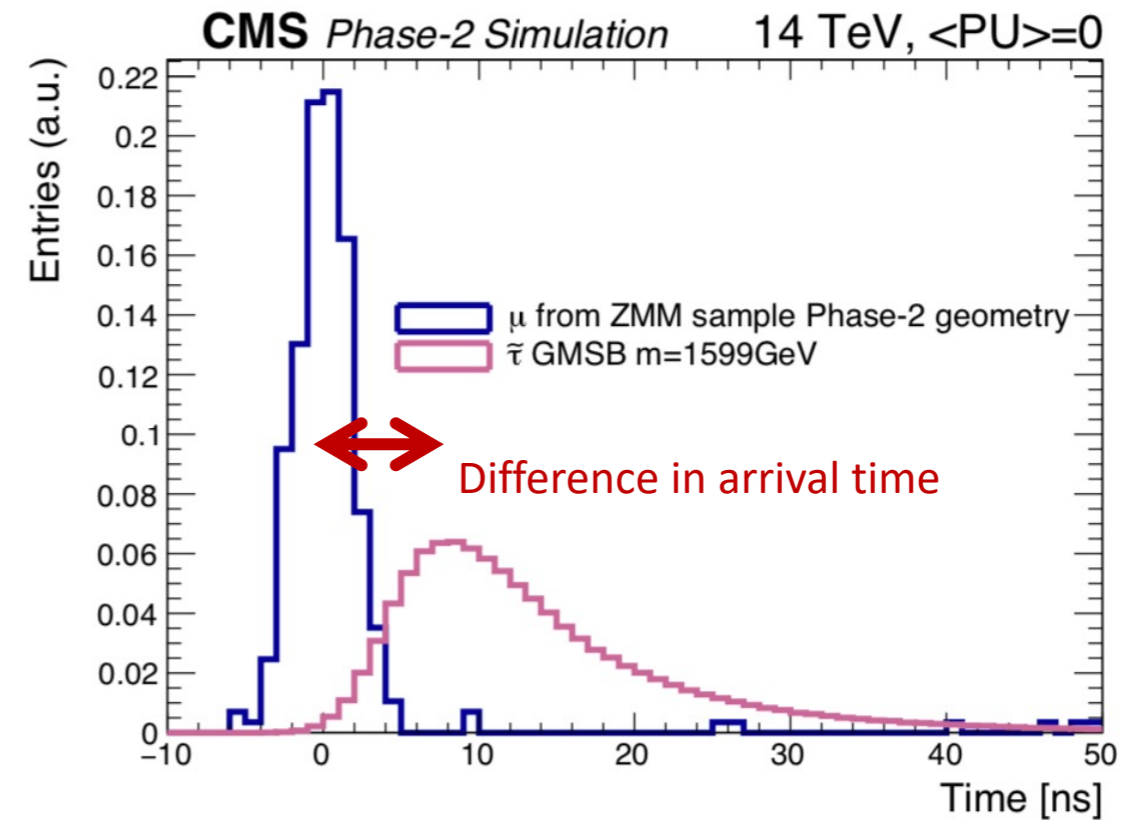

- Rates, efficiencies, precision
➔ much better, more flexible trigger
- Allows trigger on displaced tracks
 - No vertex constraint
 - New physics!?!?

Gas Electron Multiplier GEM

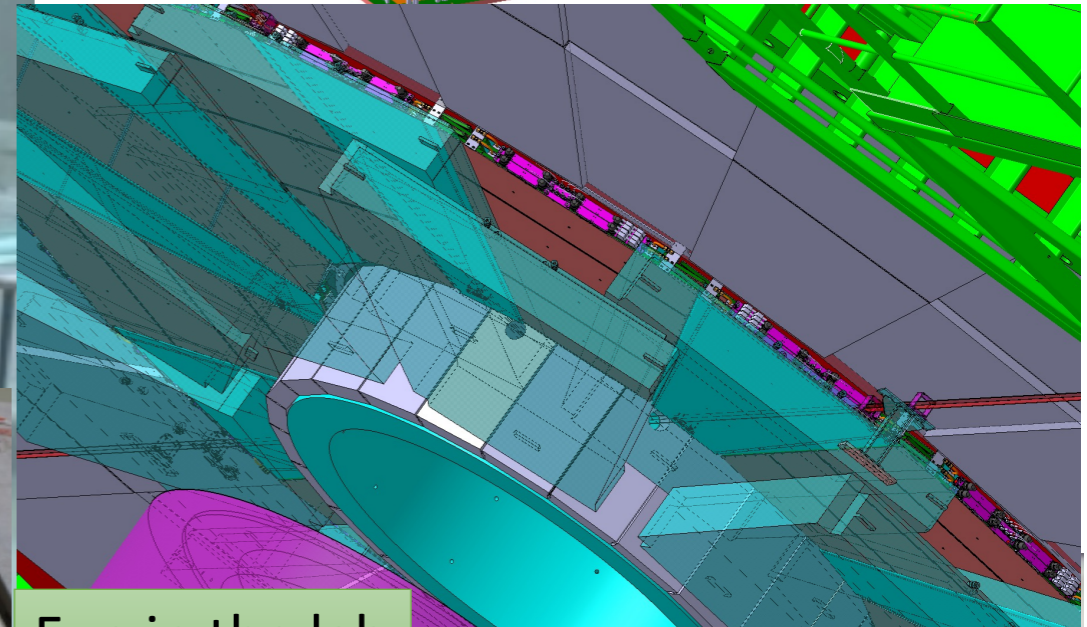
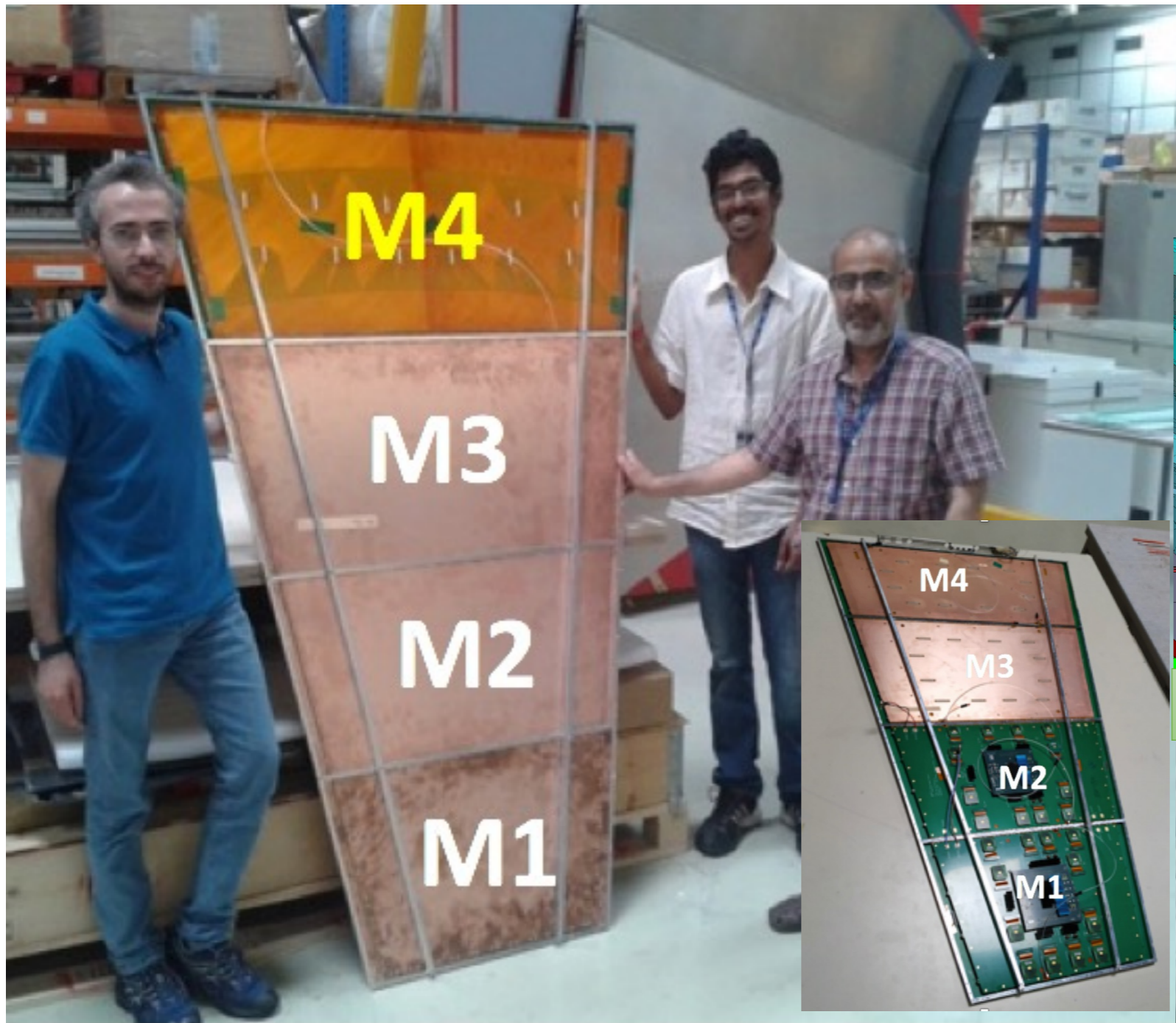
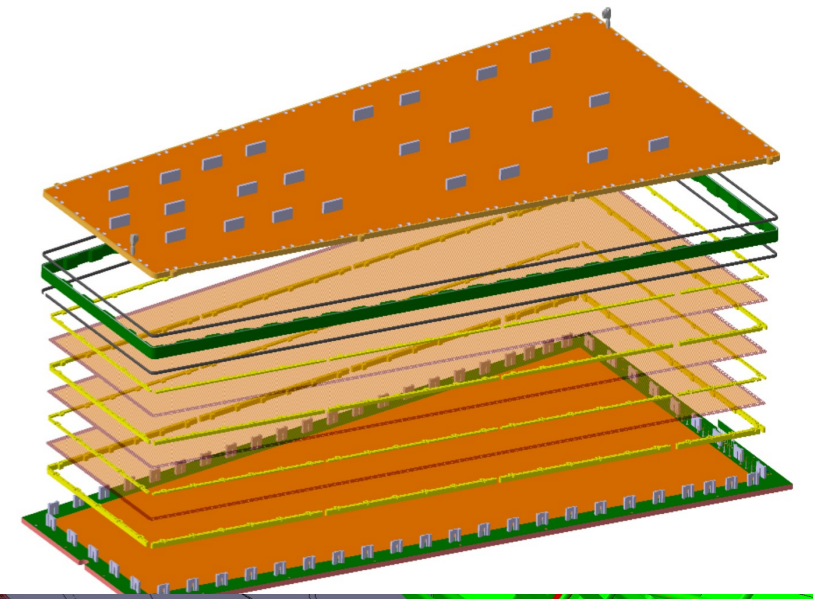

Fun in the lab



All 144 needed detectors have been installed

NB: Unprecedented scale of GEM installation!

Large installation 2019/20 (done)

RPC: New Link System Status

The RPC Off-detector electronics consist of Link and Control Boards (called "Link System"). The LS is located on the balconies around CMS.

- 3 new Link Boards have been produced at IPM lab. Initial validation successfully performed.
- Firmware deployment is progressing on schedule.

Data transmission GTX @ 10.24 Gbps

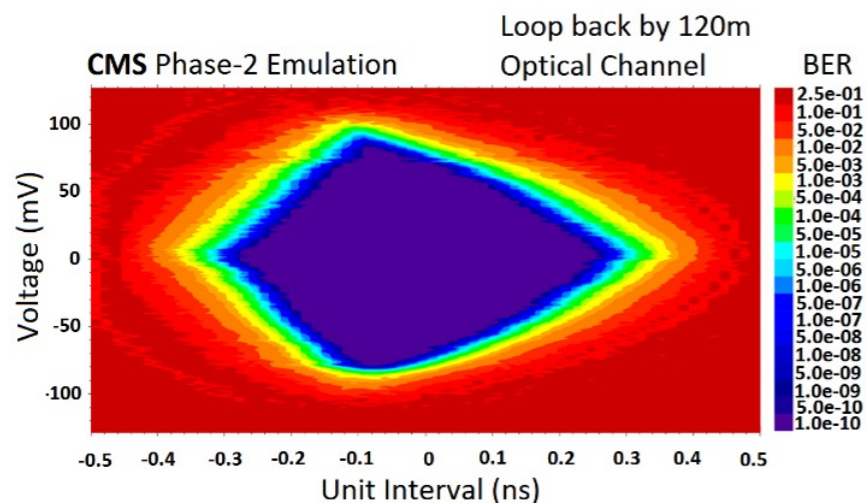

- One board arrived CERN in June 2021



Responsibility of IPM for the whole Muon Resistive Plate Chambers!

Installing services for RPCs – today

Resistive Plate Chamber

Create the future opportunities today

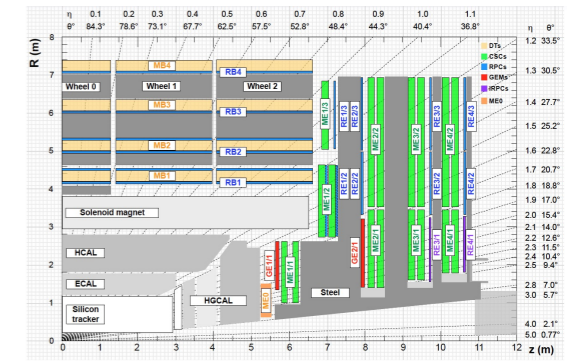

Fun at P5



RPC: Resistive Plate Chamber

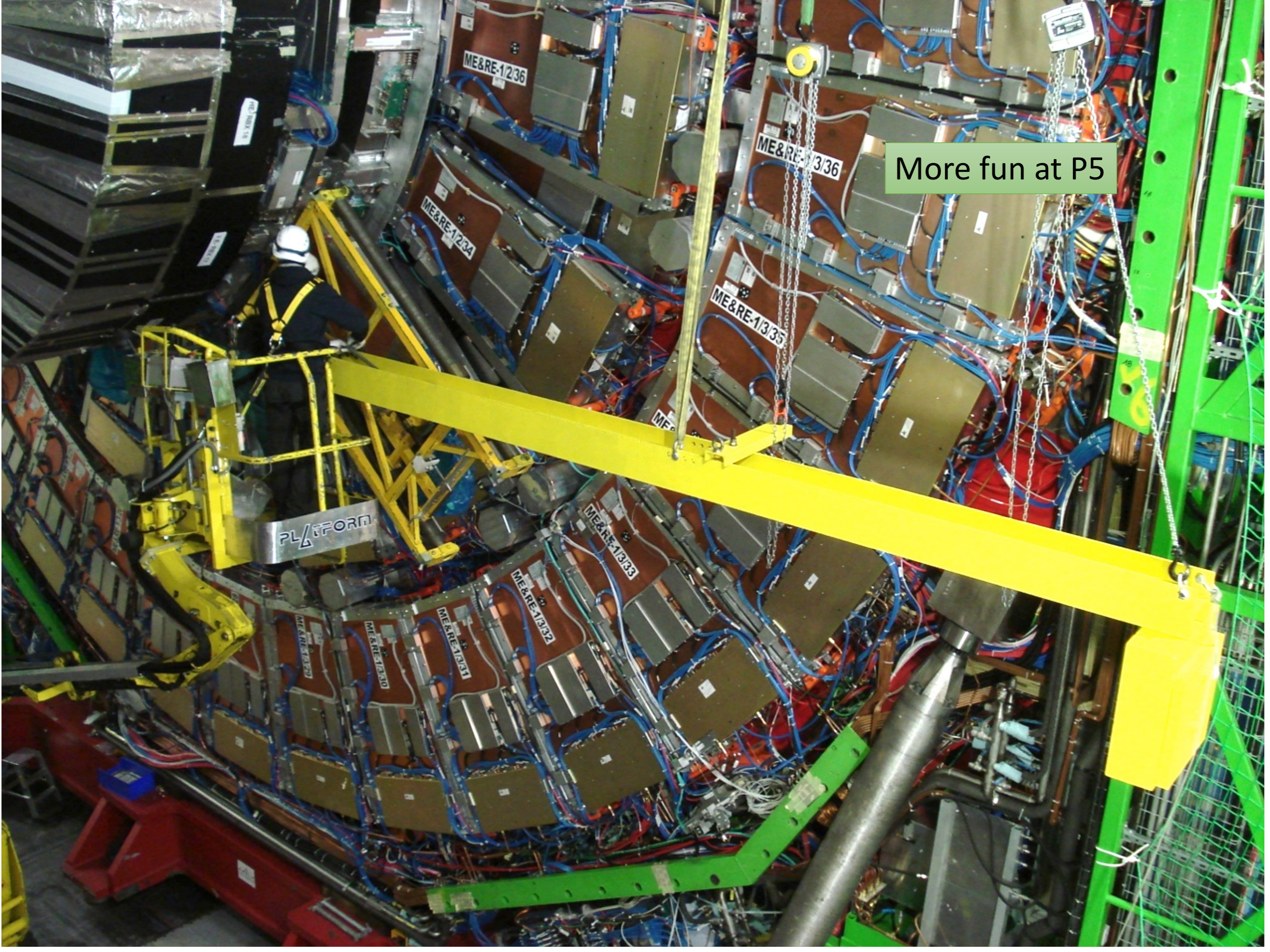

More fun at P5

PLATFORM

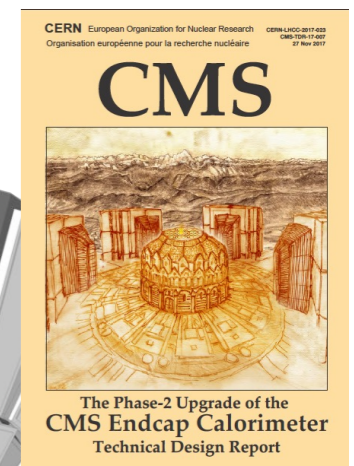
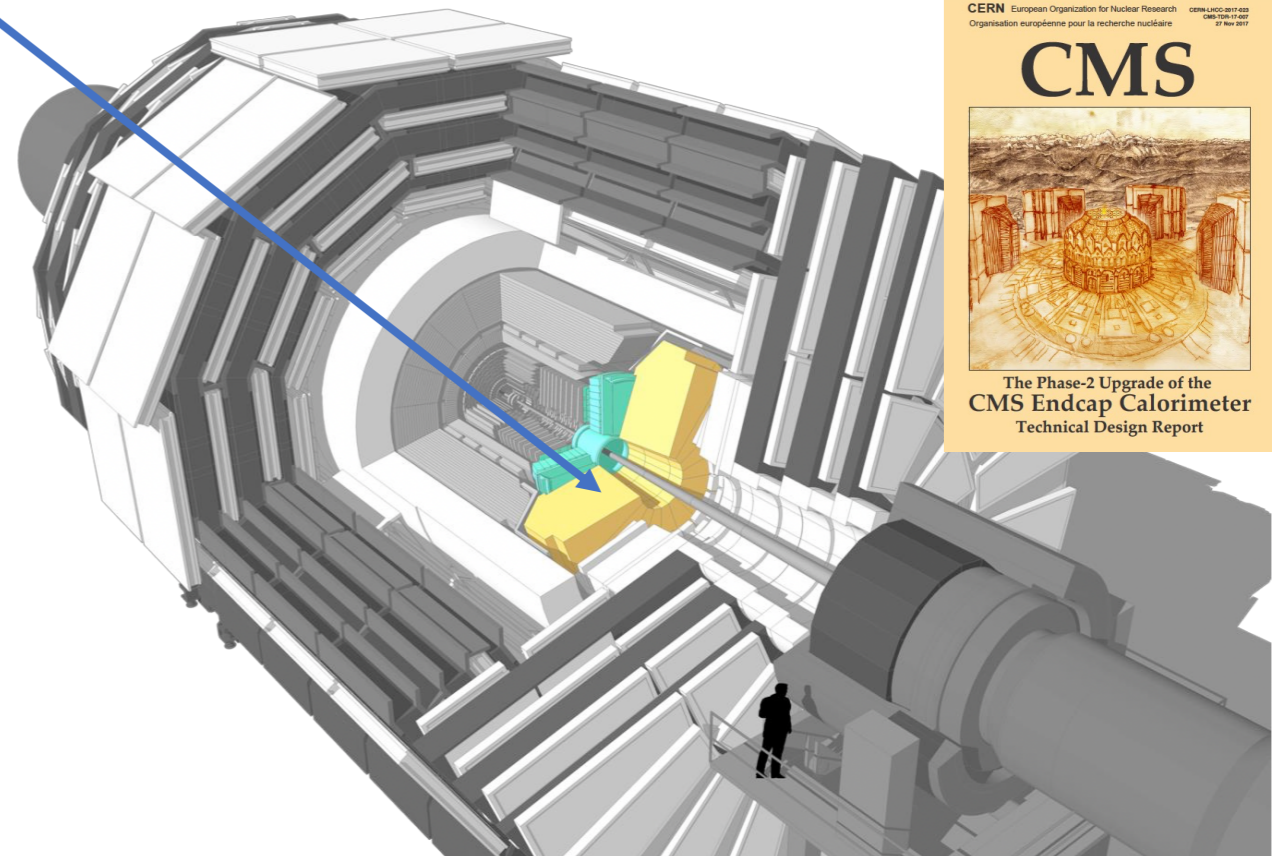
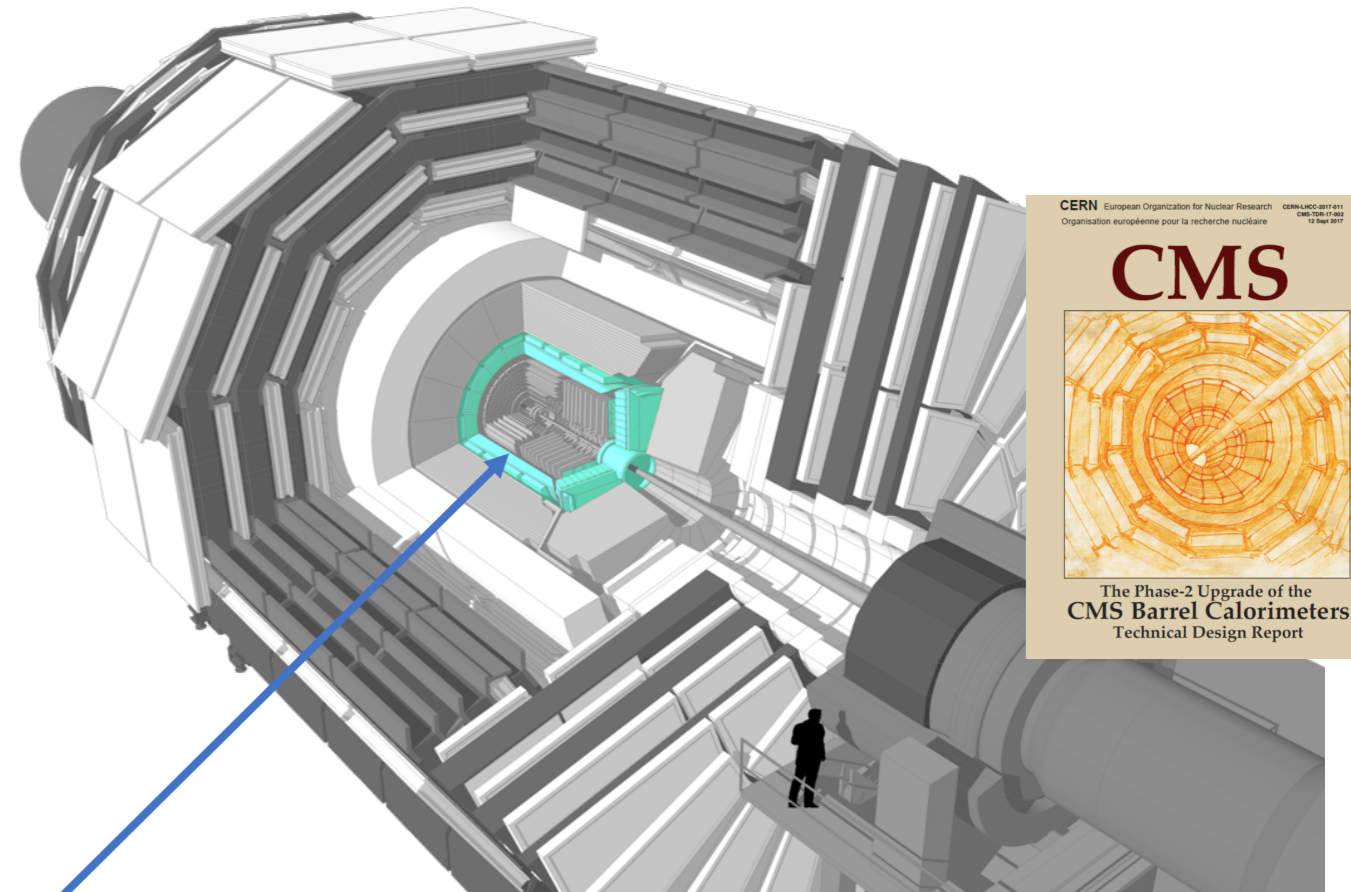
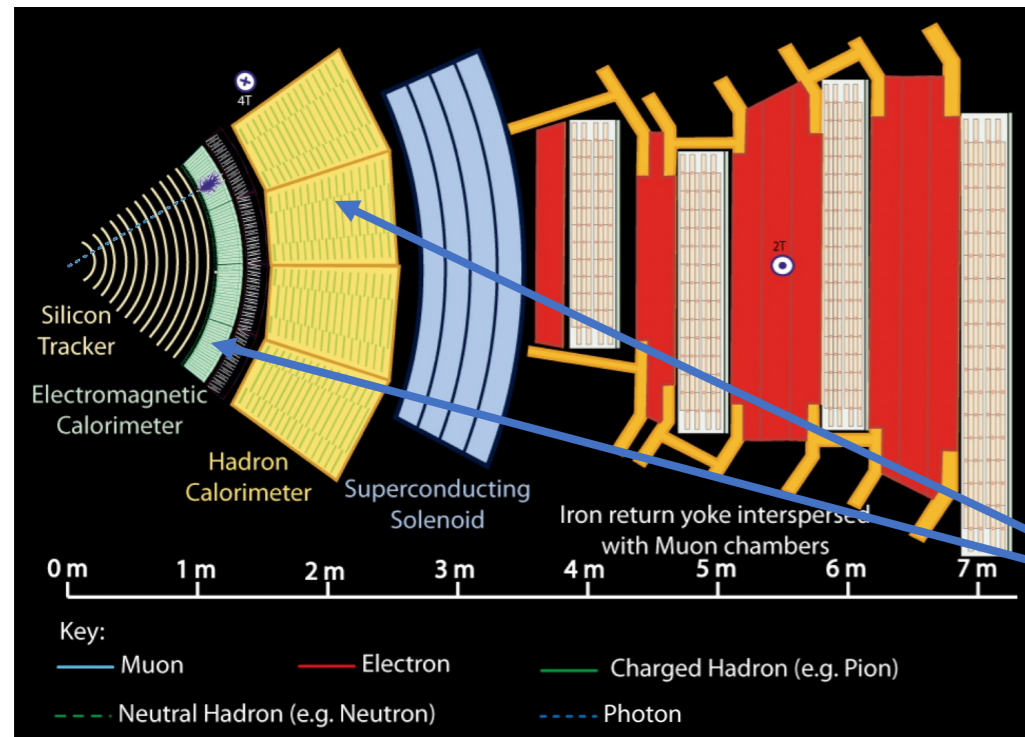

Calorimeter

Barrel and endcap

Which calorimeter to keep/replace?

Electromagnetic Calorimeter Barrel and Endcap

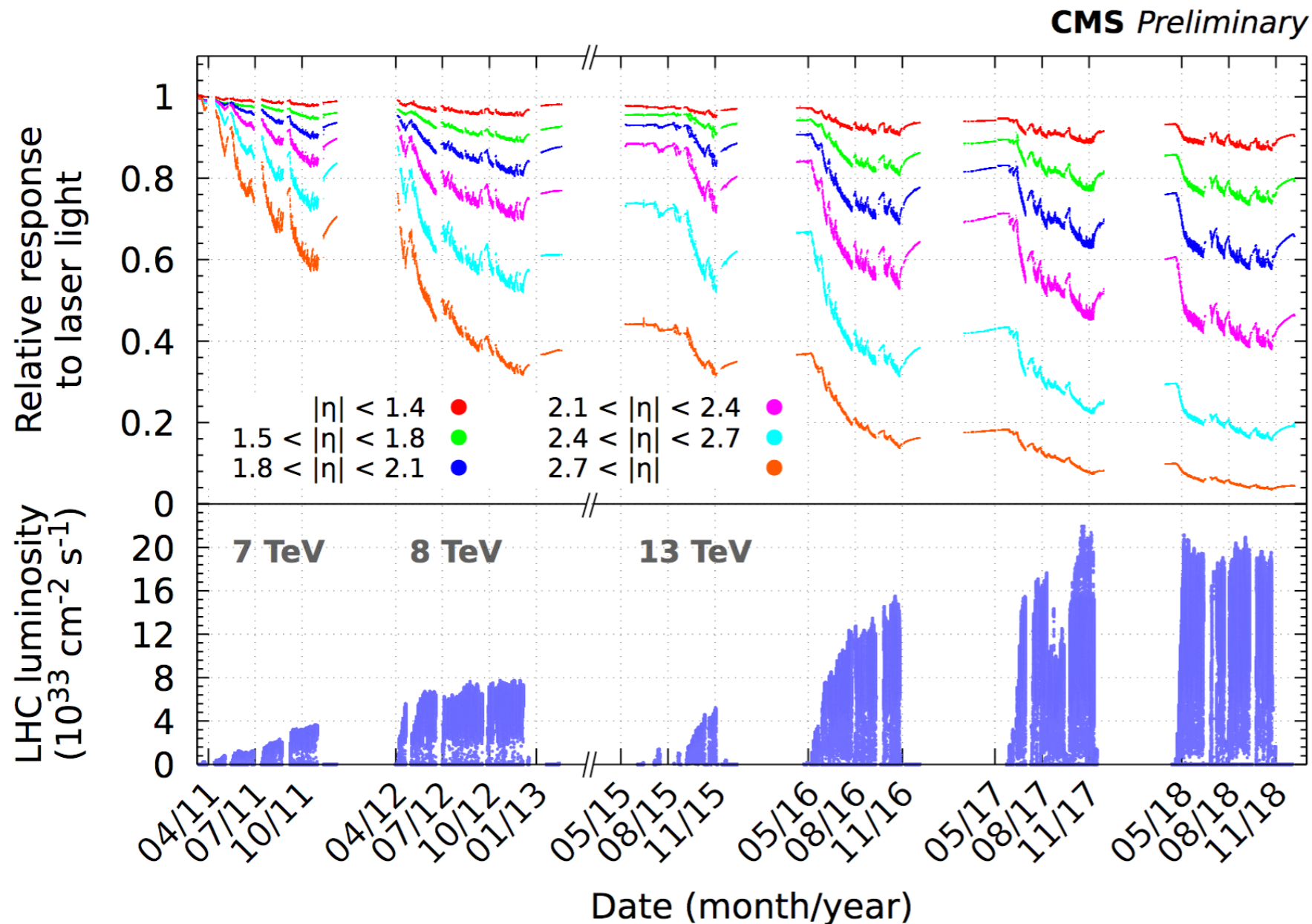

RED (barrel) OK

endcap

N

O

T OK

Hadron Calorimeter endcap response vs. Luminosity

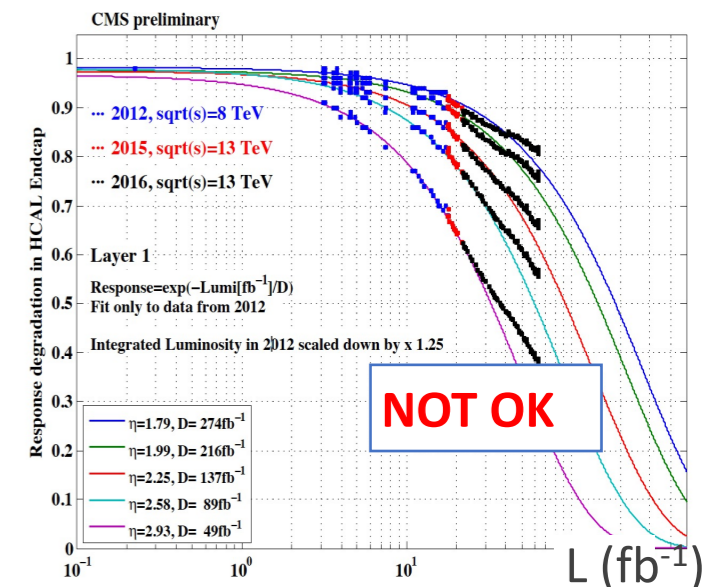

Fun at calibrations and to understand how a detector really works

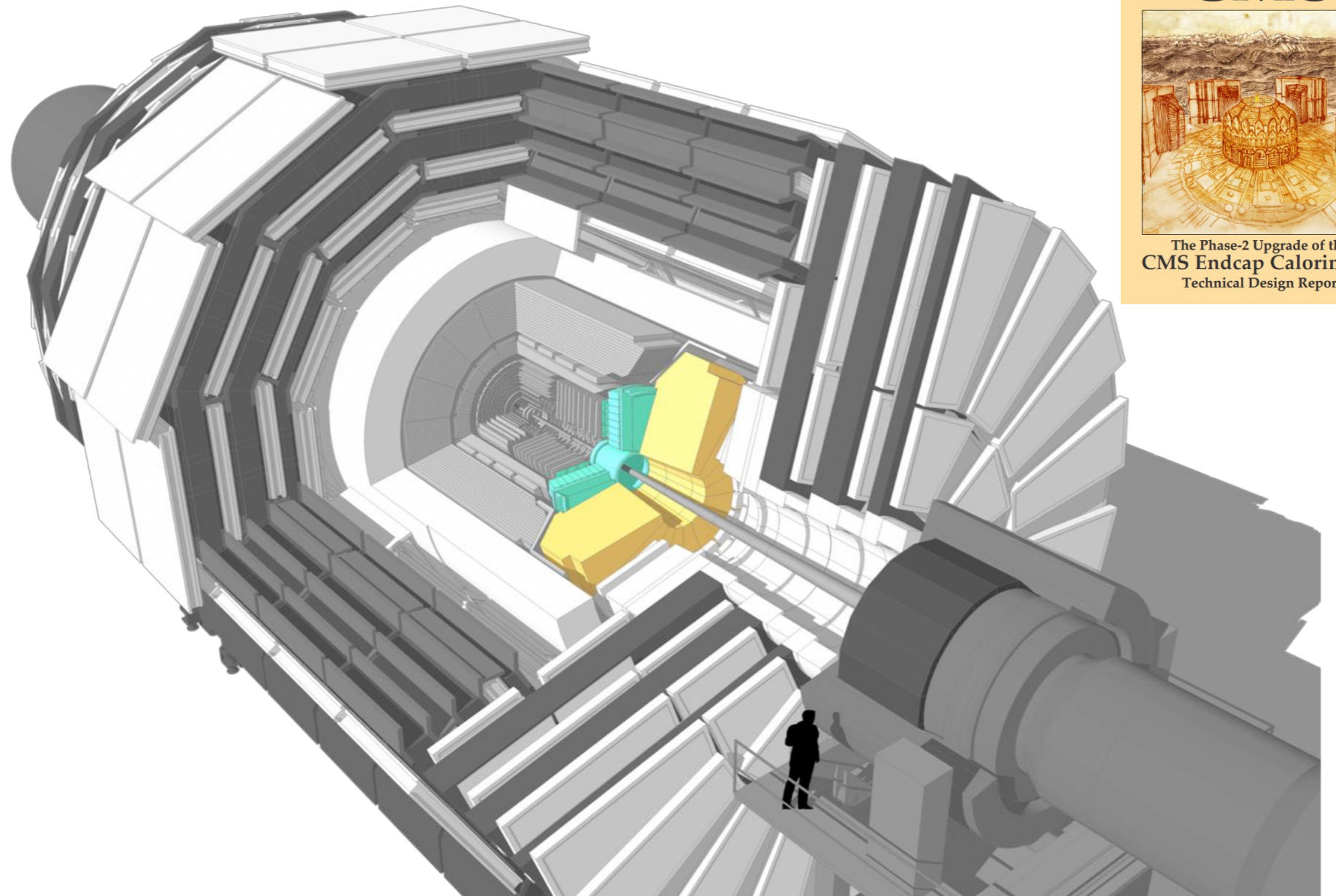

World's first

High Granularity Calorimeter

- a 5D calorimeter

“5 dimensions” measured \rightarrow (x,y,z,E,t)

Going Forward by looking backward

- Imaging Calorimetry in the endcap

Idea kindly borrowed from D. Barney



Big European Bubble Chamber
3T; L=3.5m, $X_0=34\text{cm}$

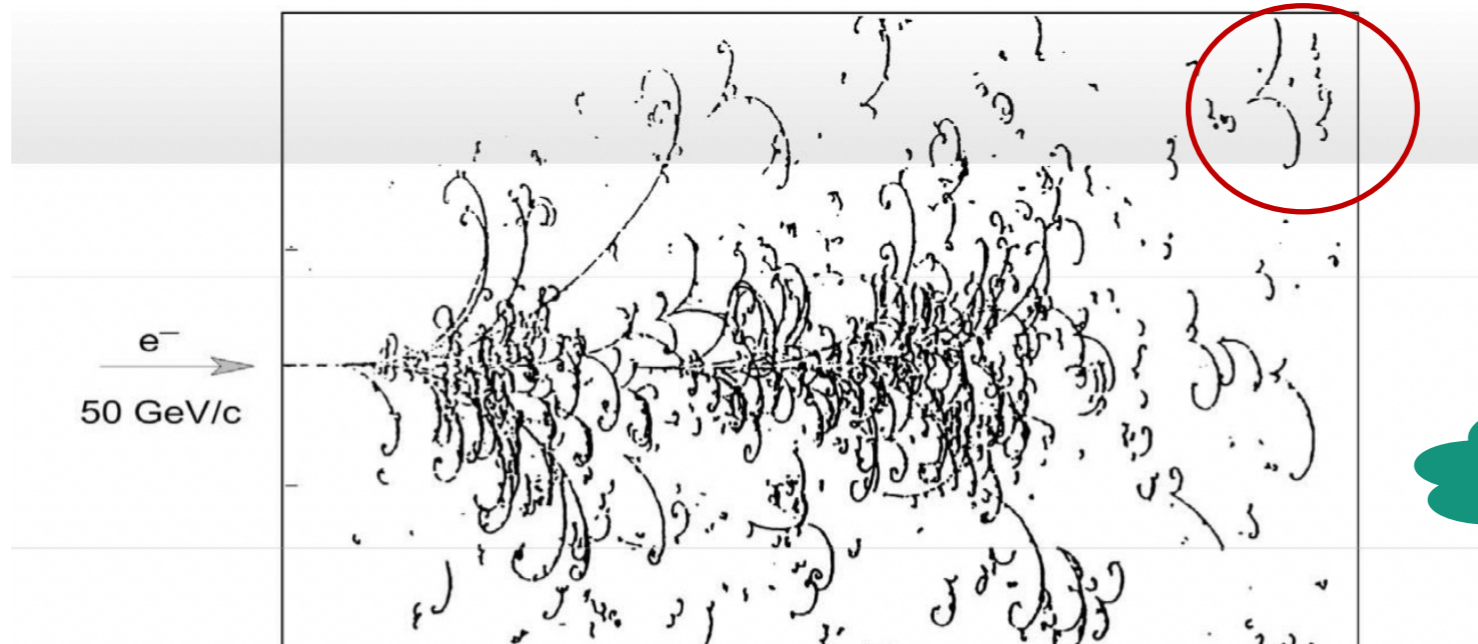

Yes, we can!

The previous generation of calorimeters could “see” showers!
Can we do this again – at 40 MHz and PU=200?

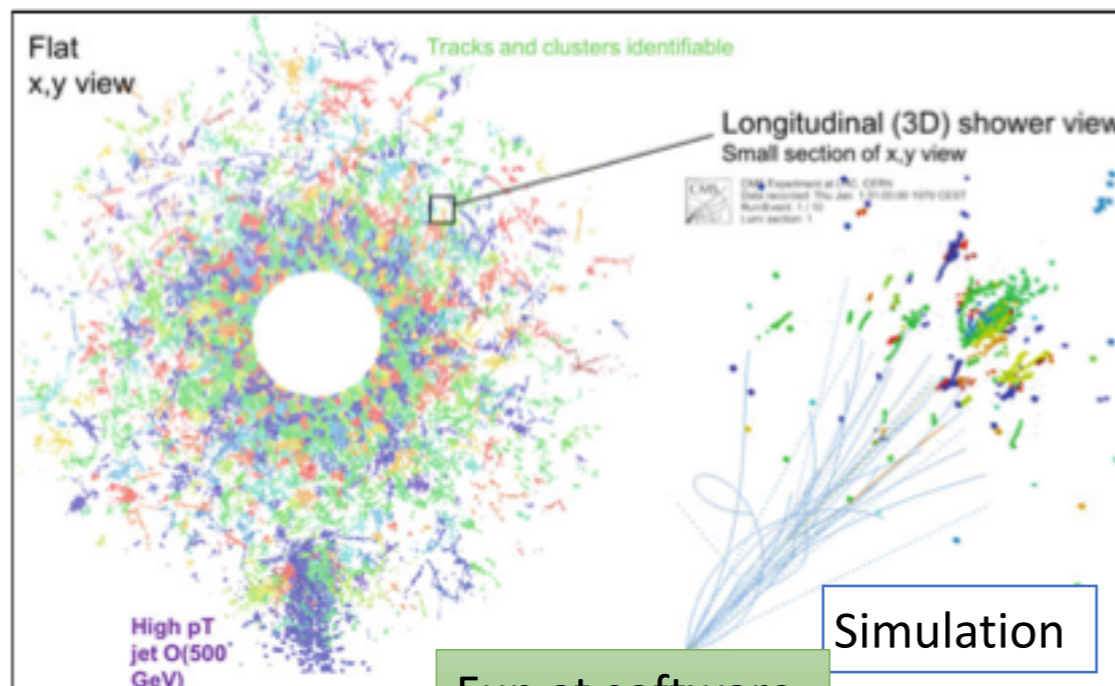
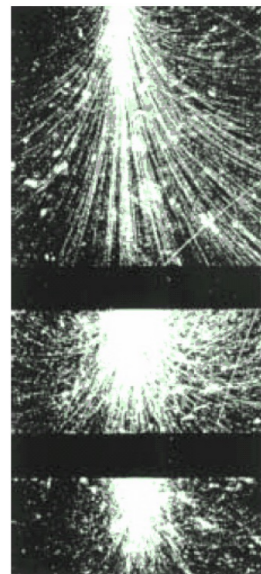

Fun at software

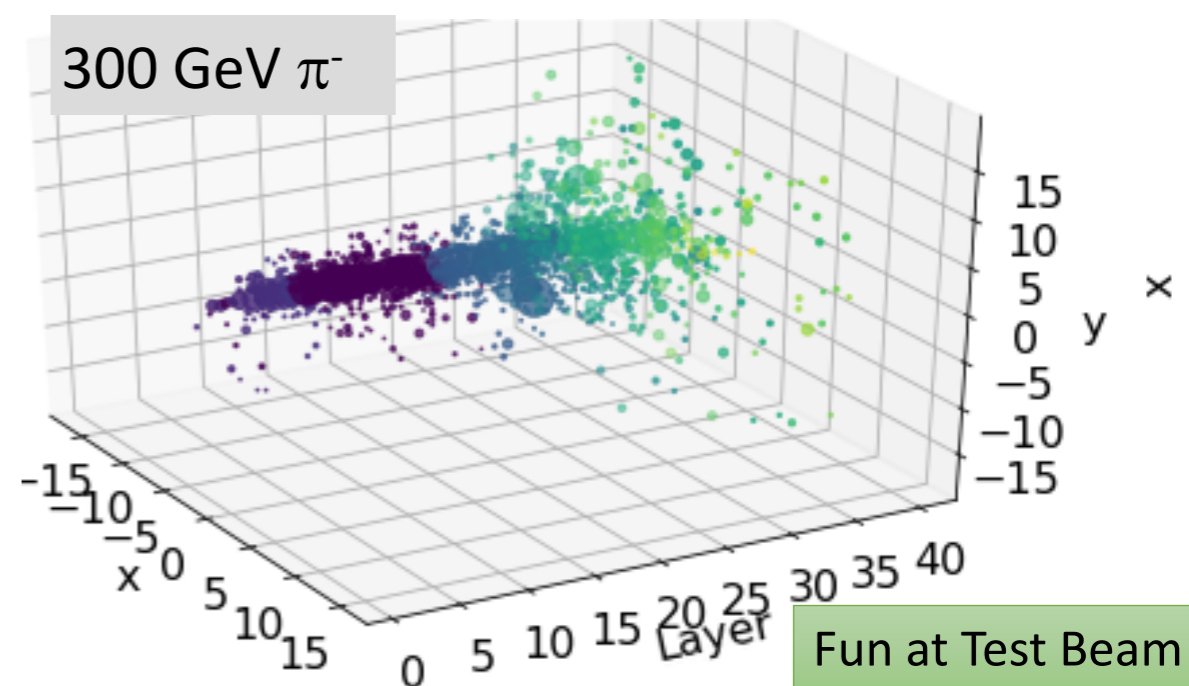

Fun at Test Beam

Replace the 230t nose

Channels:	Today	2026
Electromagnetic	15'000	→ 6'000'000
Hadron	10'000	→ 400'000

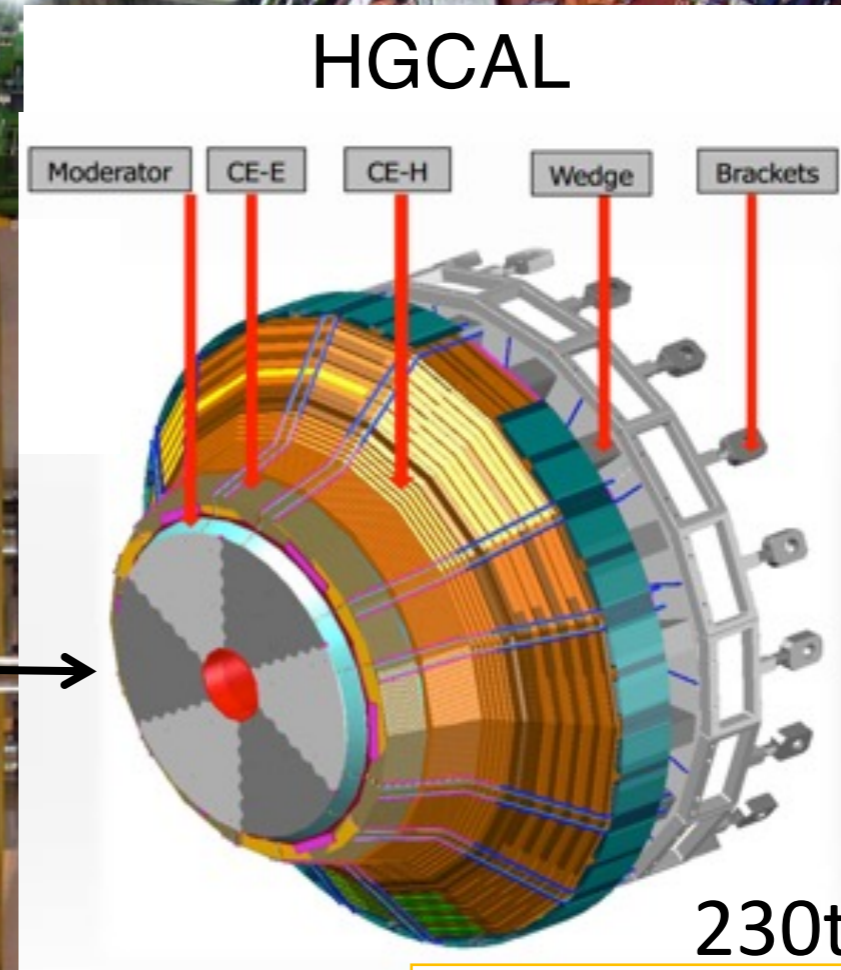

High granularity
Radiation tolerant

Silicon enters calorimetry on large scale

– World's first

- 3D shower topology and time resolution of ~ 30 ps ($p_T > \text{few GeV}$) - **5D**
 - E.g. 2% energy resolution for γ
- The silicon part** (*more rad tolerant*)
 - 600 m² of silicon
 - 8" wafers – a first in HEP**
 - 6M channels, 0.5 or 1 cm² cells
 - 25000 modules
- Plastic scintillator** (*less rad tolerant*)
 - 500 m² of scintillators
 - $\sim 400k$ scintillator & SiPMs on tile
- High granularity
 - A dream for Particle Flow concept (PF)

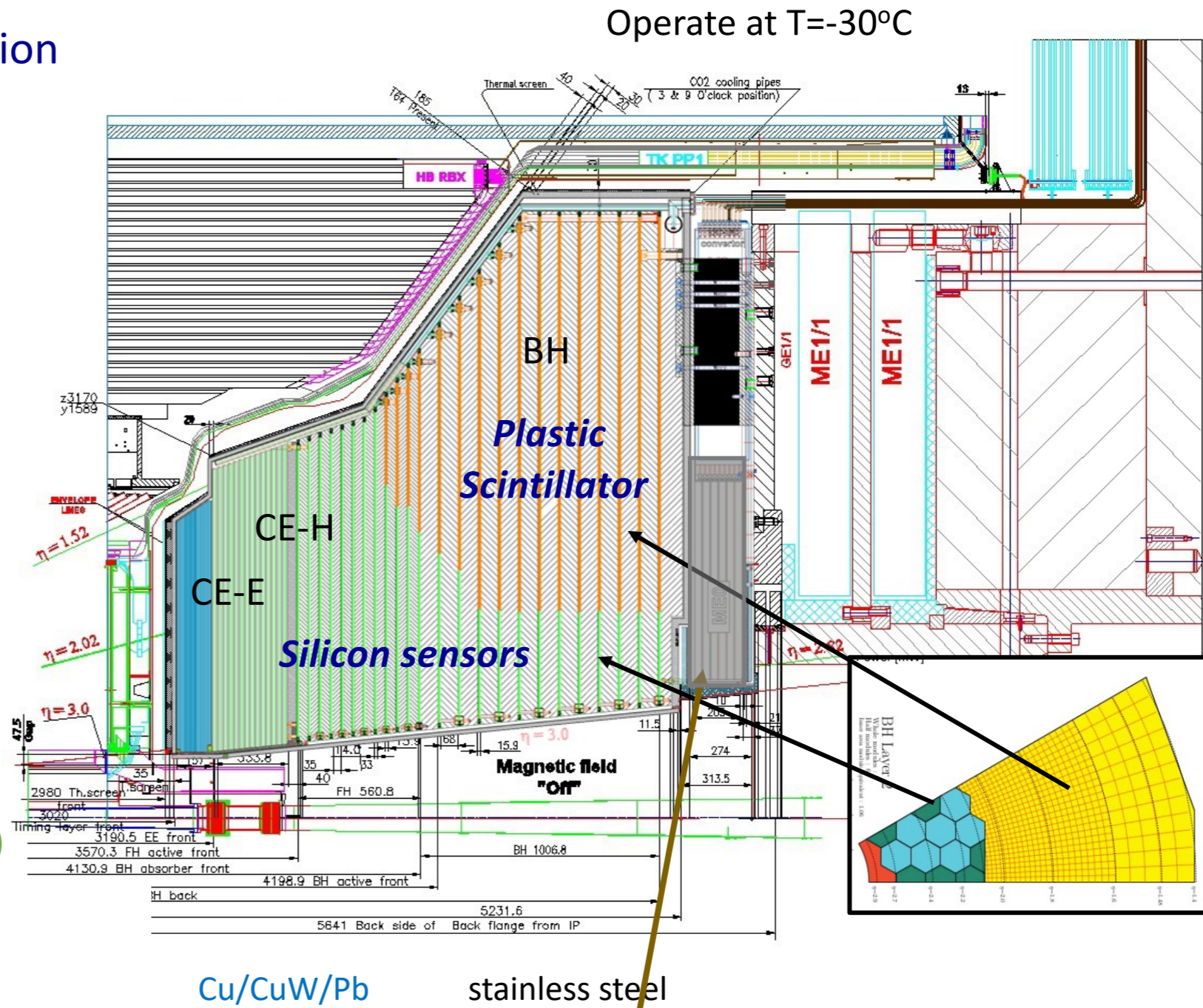

CE-E: 28 sampling layers – $26 X_0 + \sim 1.7 \lambda$

22 sampling layers – 9λ

Btw: Muon GEM

CERN-LHCC-2017-023 CMS-TDR-019

- measure tracks
- tag b-quarks

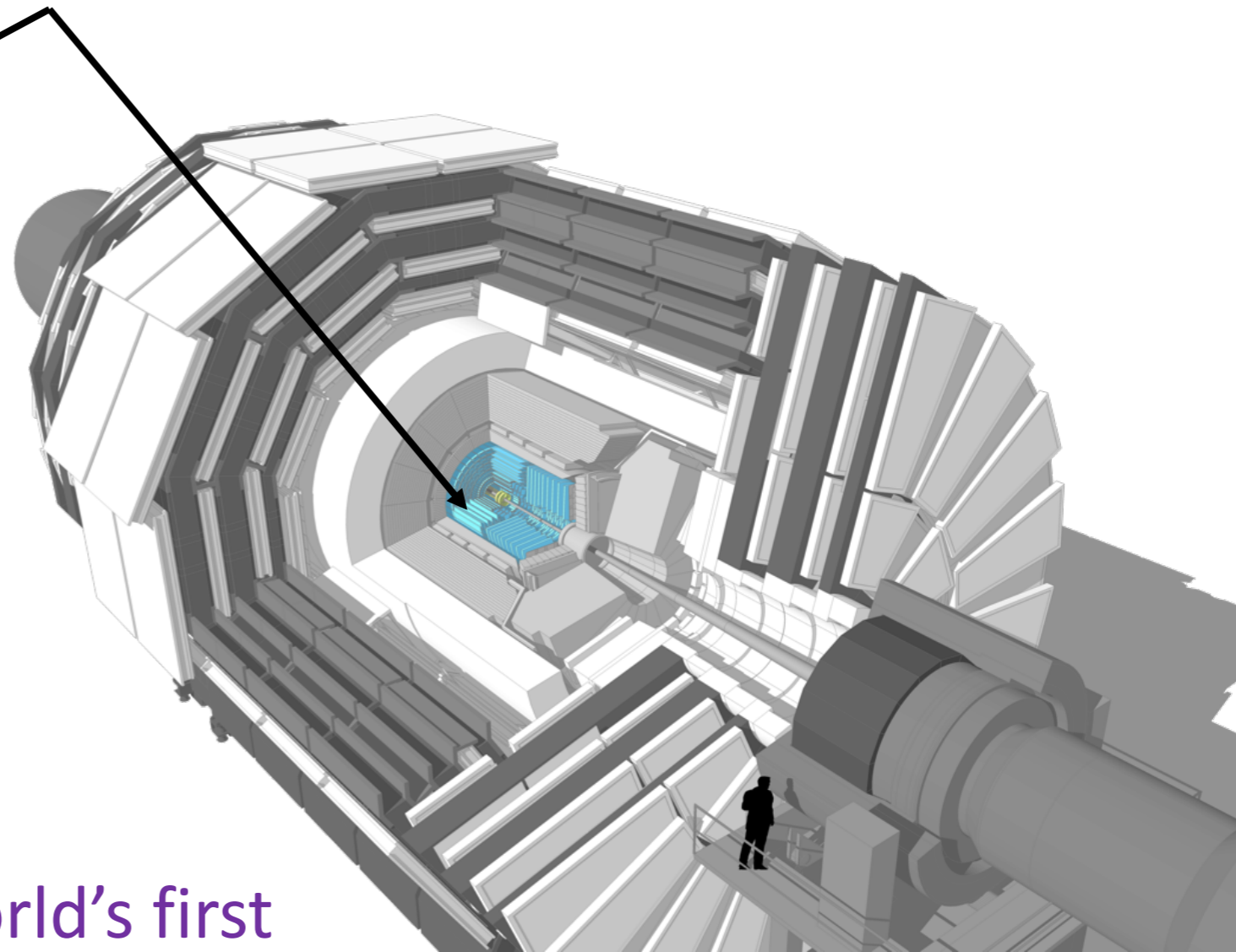
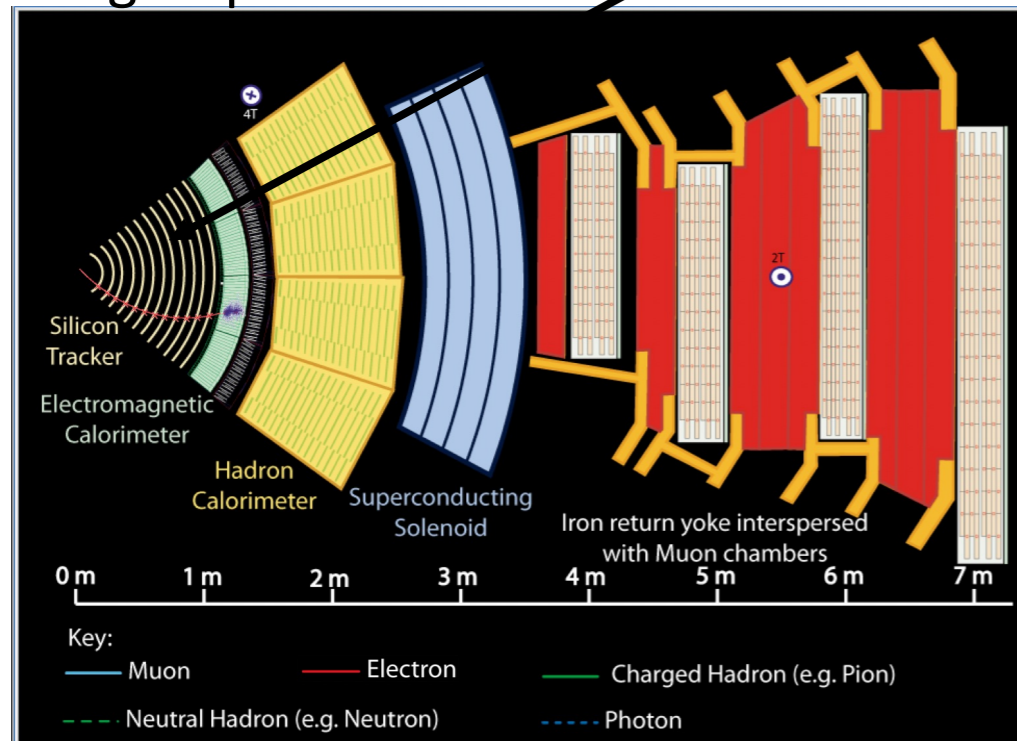

Track Trigger at 40MHz - world's first

Tracker

Build a new, better, more beautiful one

Thank you IPM for supporting Tracker for some years!
Maybe you will join again later!

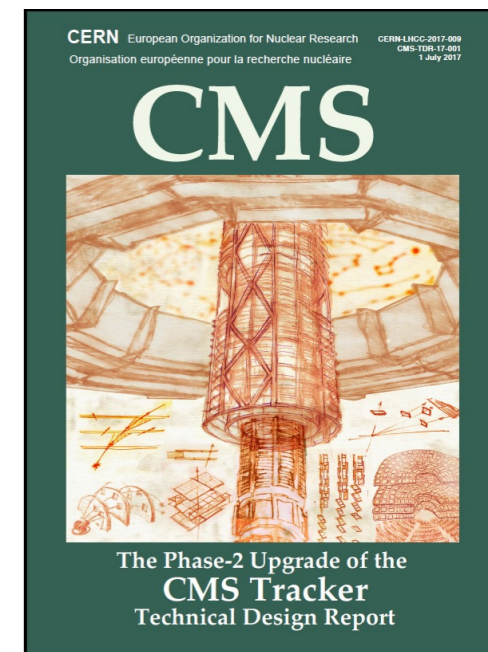

Flying Tracker

2008 in – 2024 out – 2026 new one in

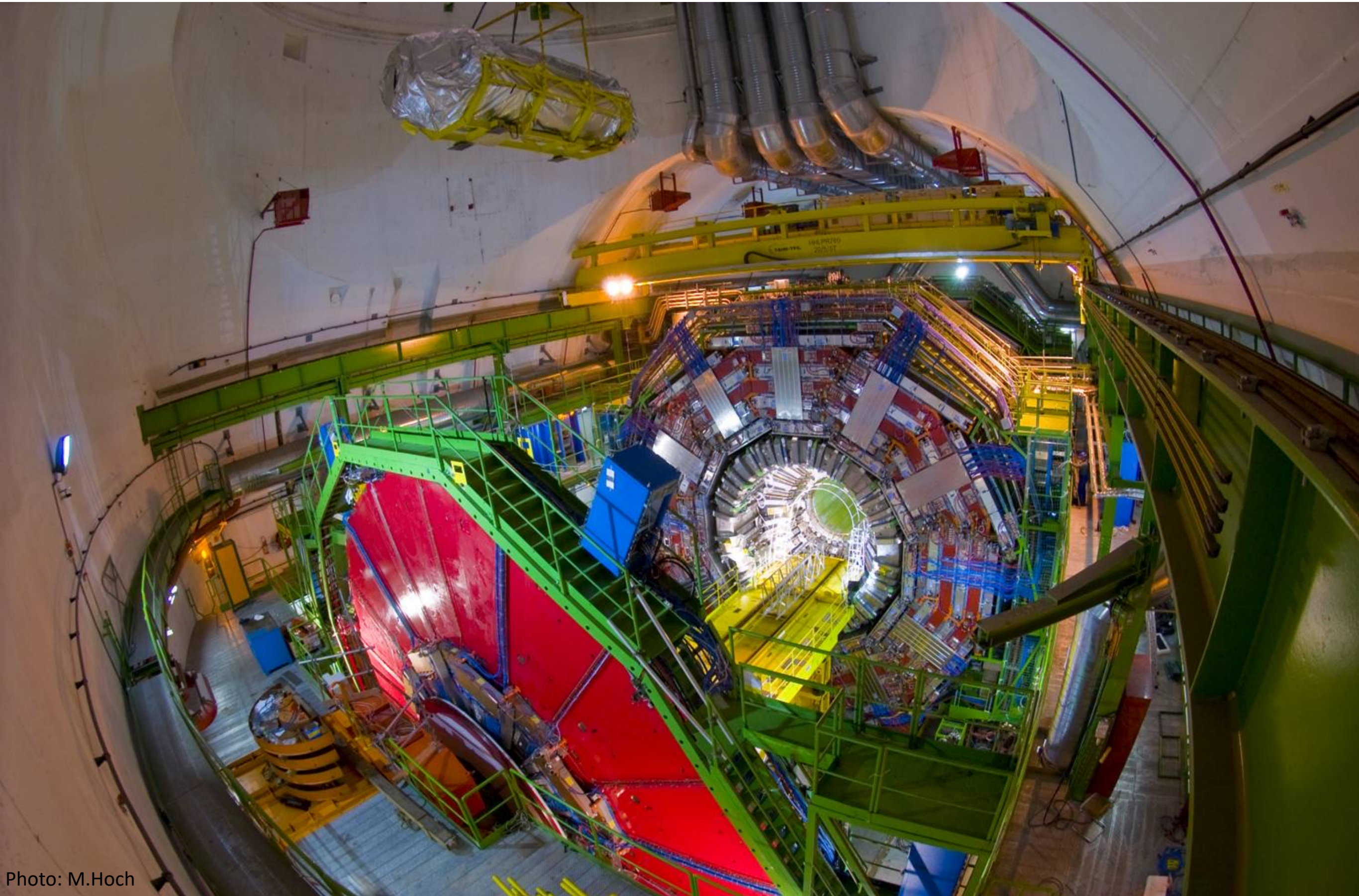

The new Beauty

- Outer Tracker design driven by ability to provide tracks at 40 MHz to L1-trigger ($p_T > 3\text{GeV}$)
 - World's first
- Tilted modules in three OT layers
- Inner Tracker (pixel) extend coverage to $\eta \approx 3.8$

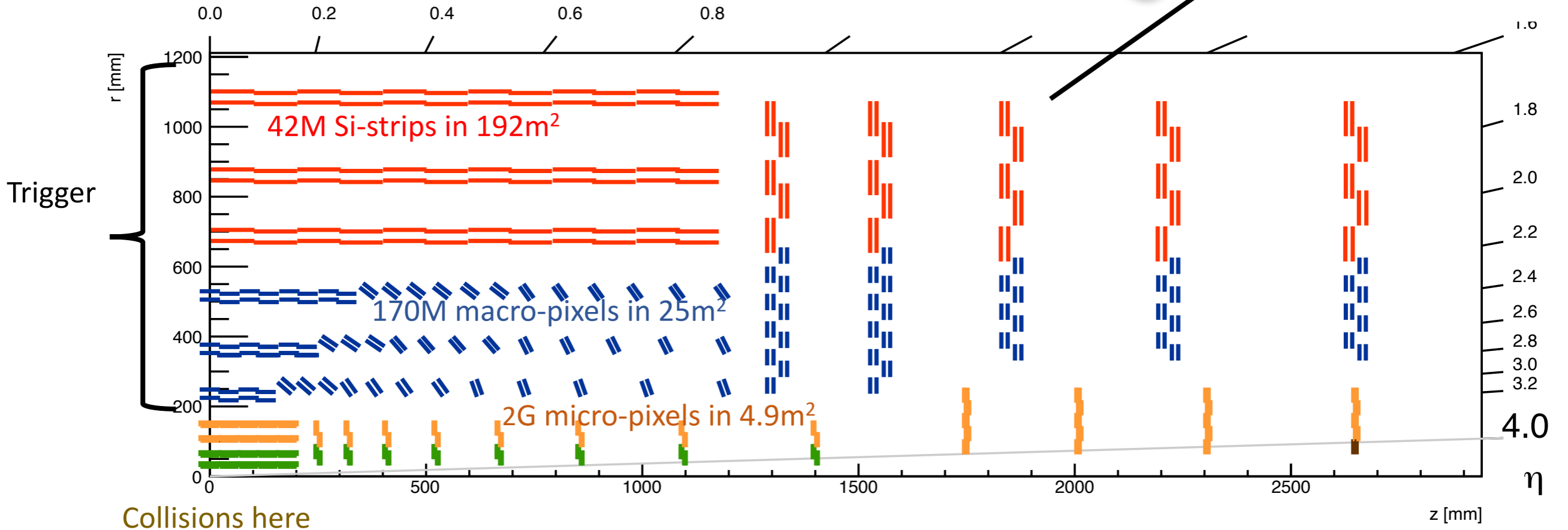
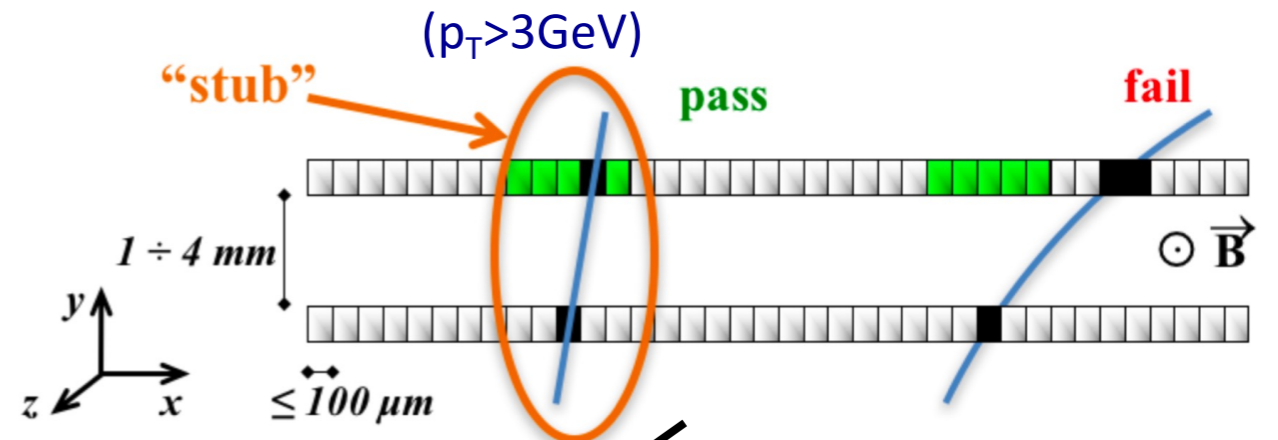
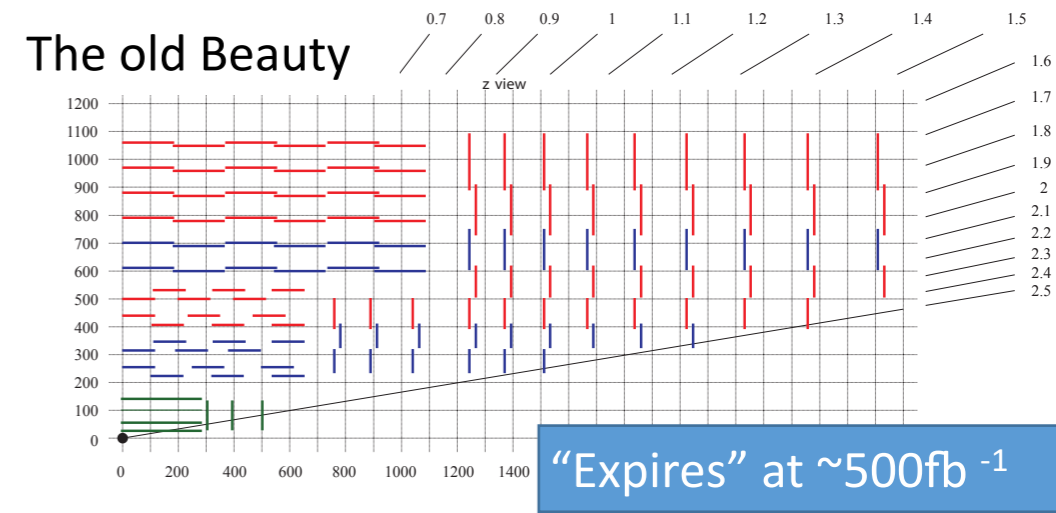

New Technologies – Tracker Module

New concept

- Contains ALL electronics = full system
- Effective way to have 2 space points in single mechanics – lightweight
- Gives ‘vectors’ instead of points
- Tag high p_T segments

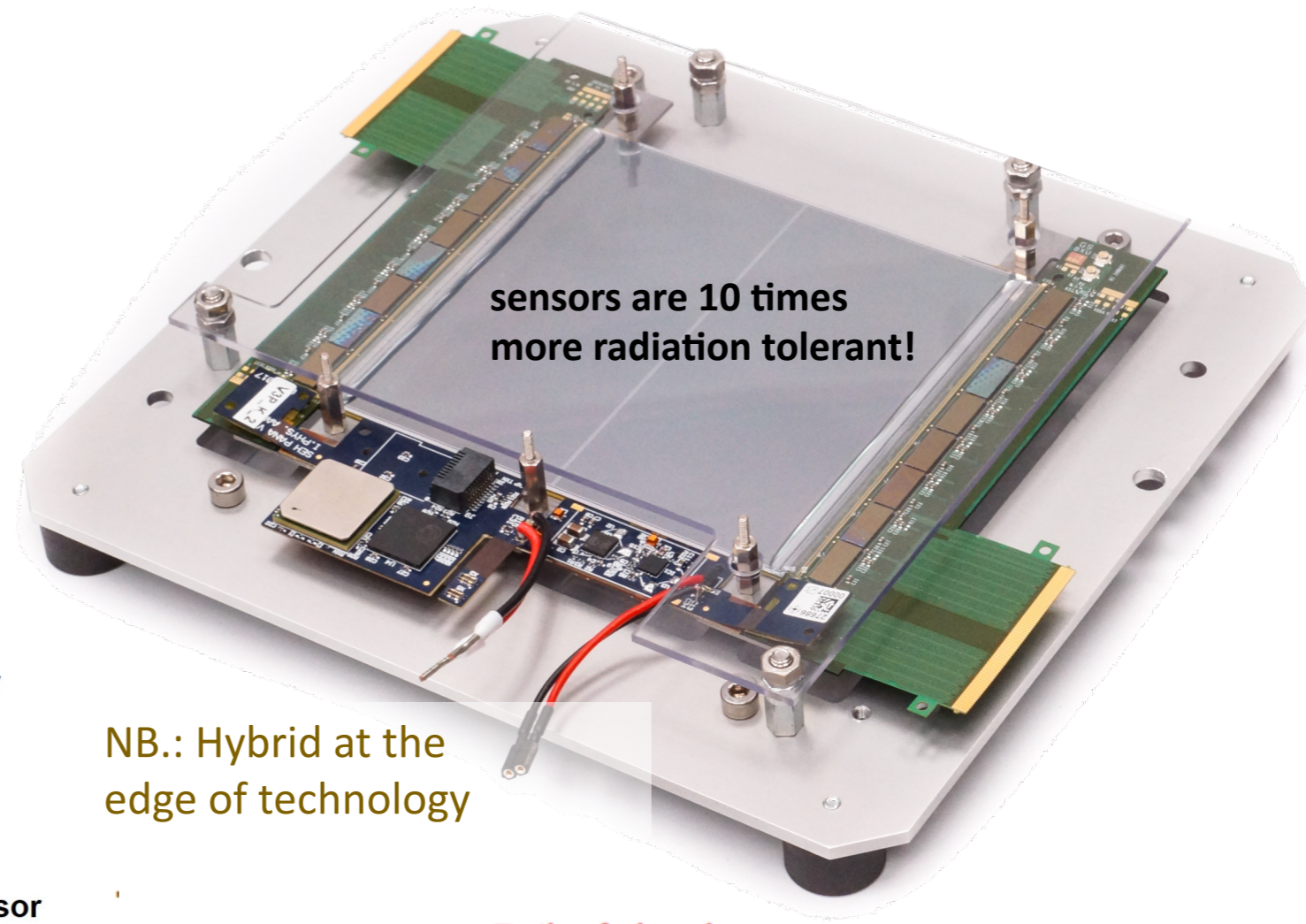

sensors are 10 times more radiation tolerant!

NB.: Hybrid at the edge of technology

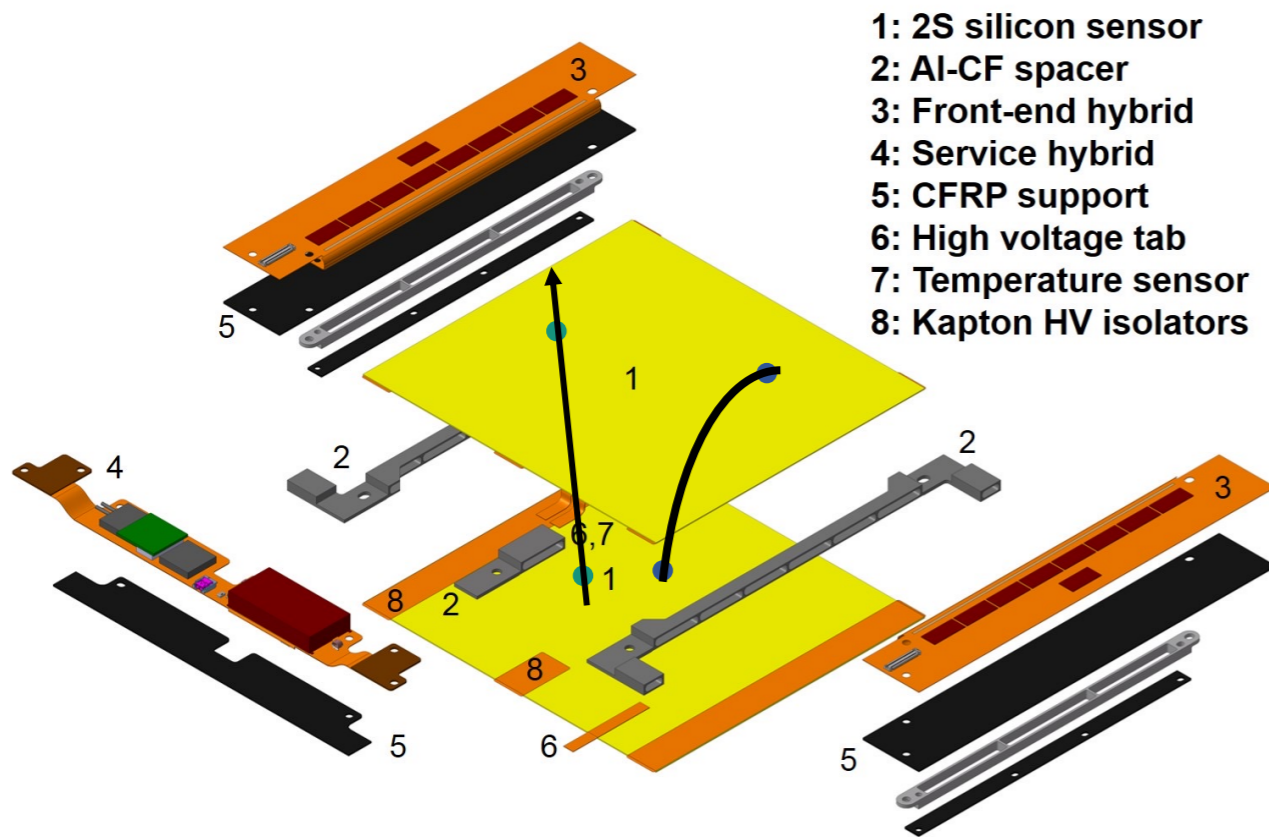

- 1: 2S silicon sensor
- 2: Al-CF spacer
- 3: Front-end hybrid
- 4: Service hybrid
- 5: CFRP support
- 6: High voltage tab
- 7: Temperature sensor
- 8: Kapton HV isolators

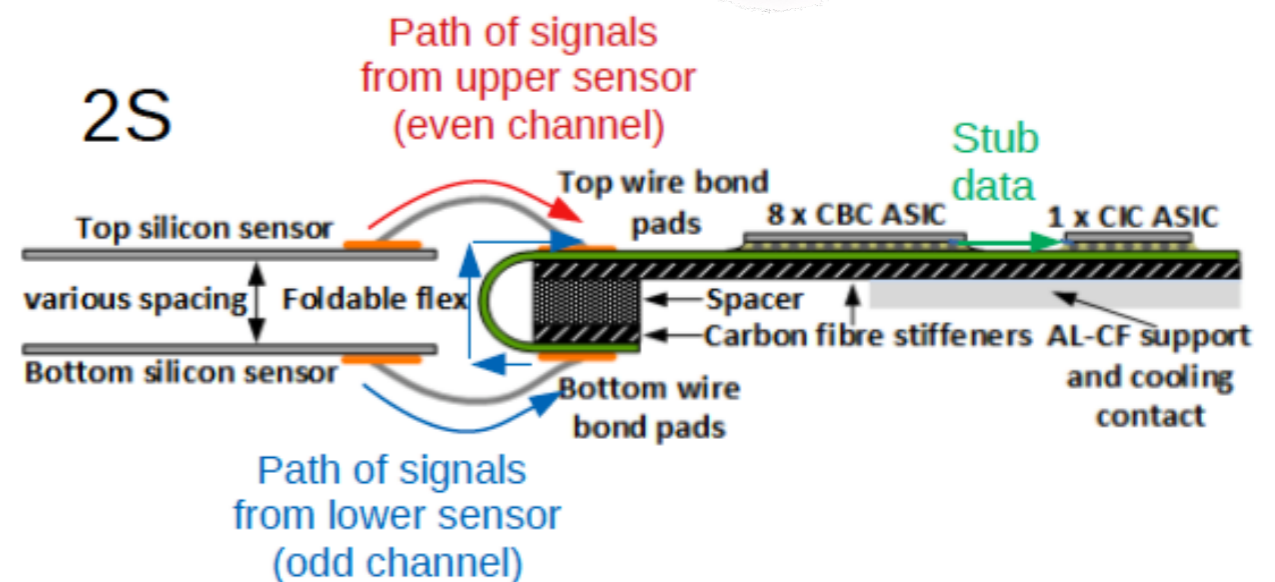

NB.: ~5 years of engineering and modelling

We extend into the forward region

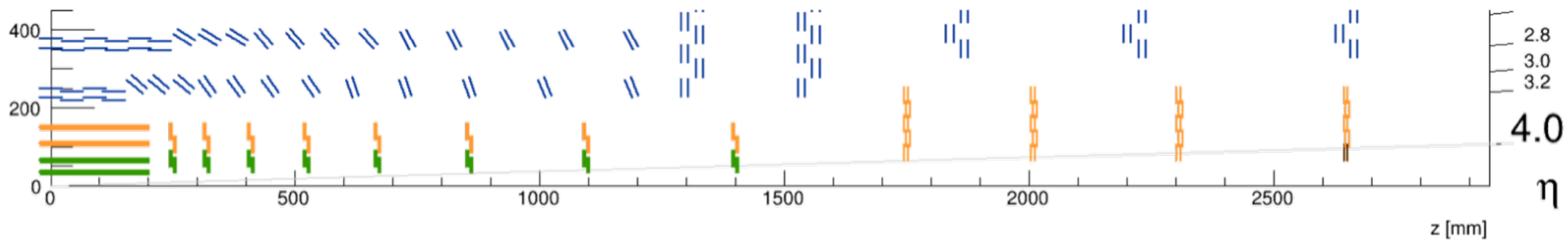

- Half-shells permit installation/extraction with beam pipe in place
 - **BIG** advantage as it allows maintenance/repairs

- Low radius helps excellent b-tagging
- Coverage up to $\eta=4$
- 3.900 modules = 2 billion pixels
- Surface: 4.9 m² (today 1.75)
- Pixels: 25x100 μm^2 (today 100x150 μm^2)
 - mandatory with high pile-up
- Hit rate: 3 GHz/cm²

→ VBF

→ b-tagging

→ PU mitigation

NB.: Pixel chip development:
24 institutes - 5 years of work

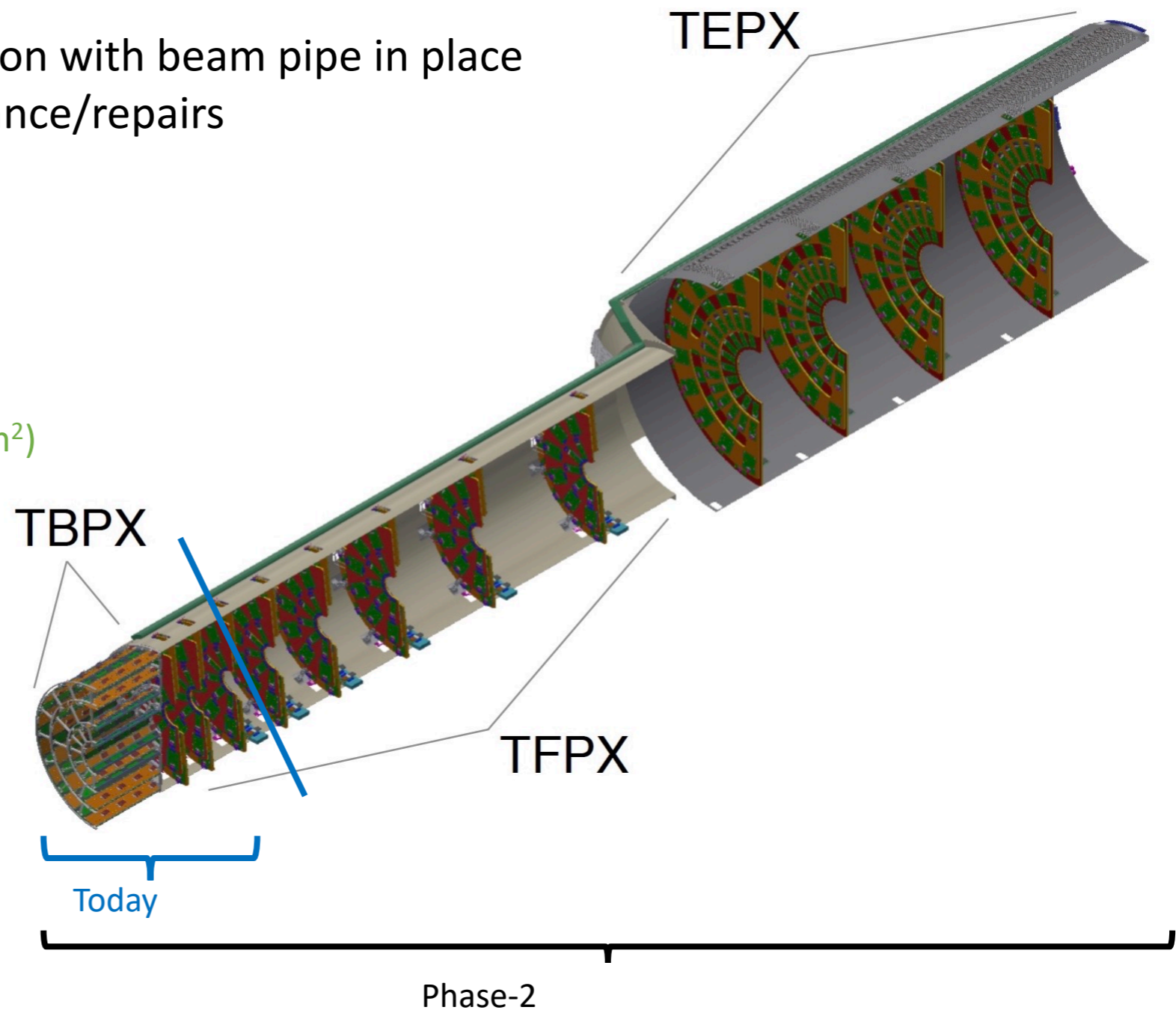

Tracker-2 Performance

p_T resolution

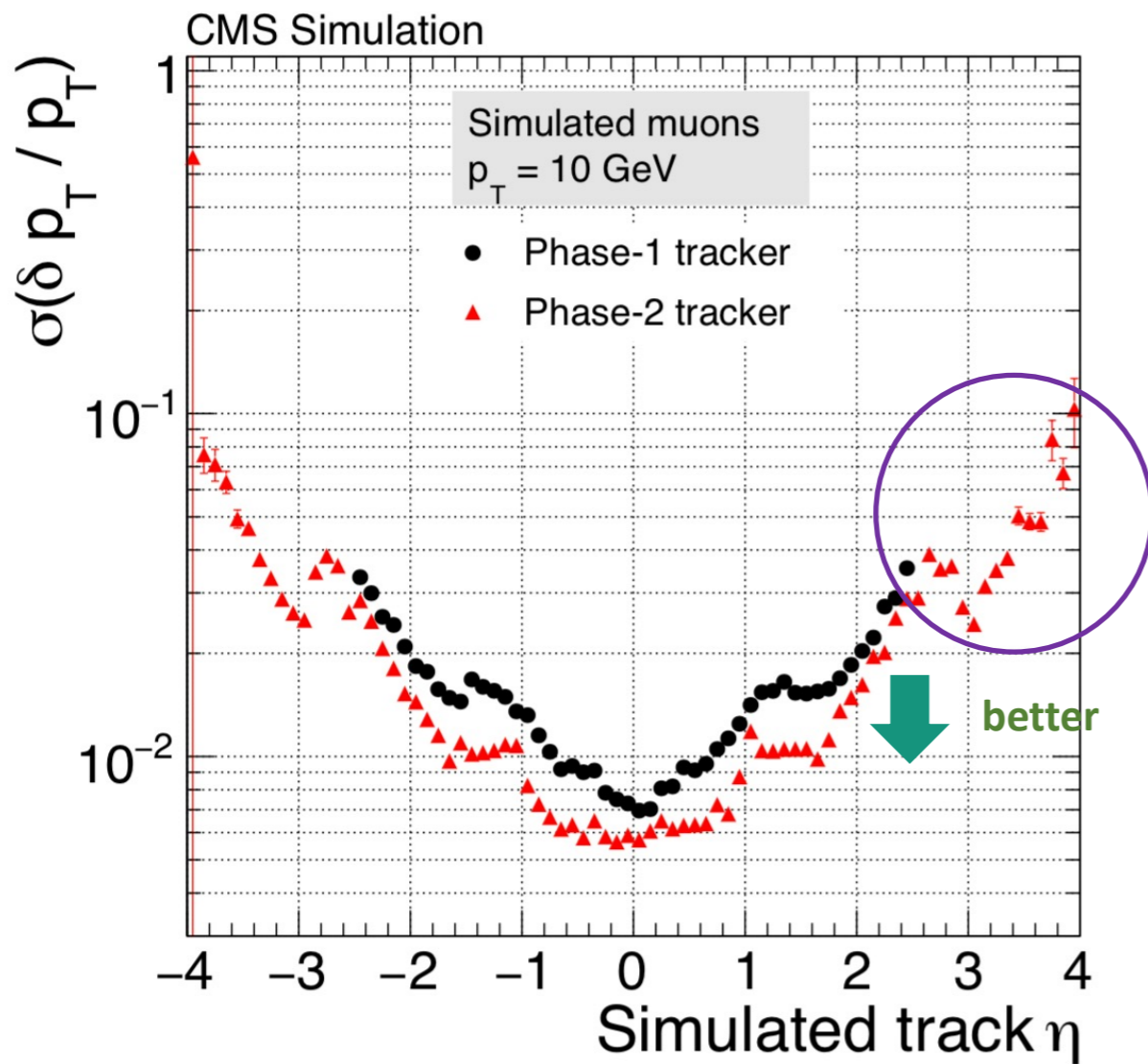

$H \rightarrow \mu\mu$: coupling to muons

- 65% improvement on $m_{\mu\mu}$ in barrel-barrel category (0.65% mass resolution)
- 5% coupling precision possible with 3000fb^{-1}

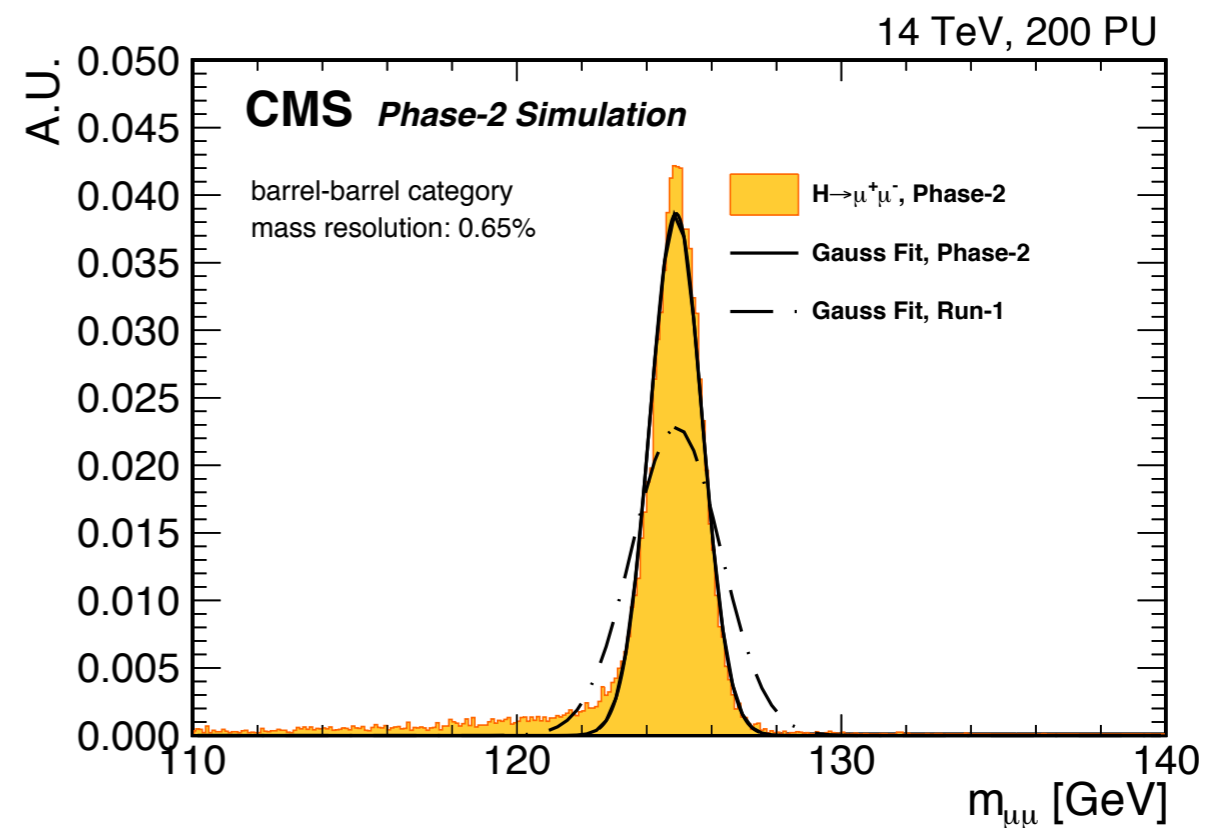

- More precise tracking parameters
 - Largely due to reduced material budget, thus less multiple scattering
- Extended coverage, allowing e.g. better forward jet reconstruction
 - Helps PU-mitigation, VBF, di-Higgs

Insertion of the Tracker into the Heart of CMS

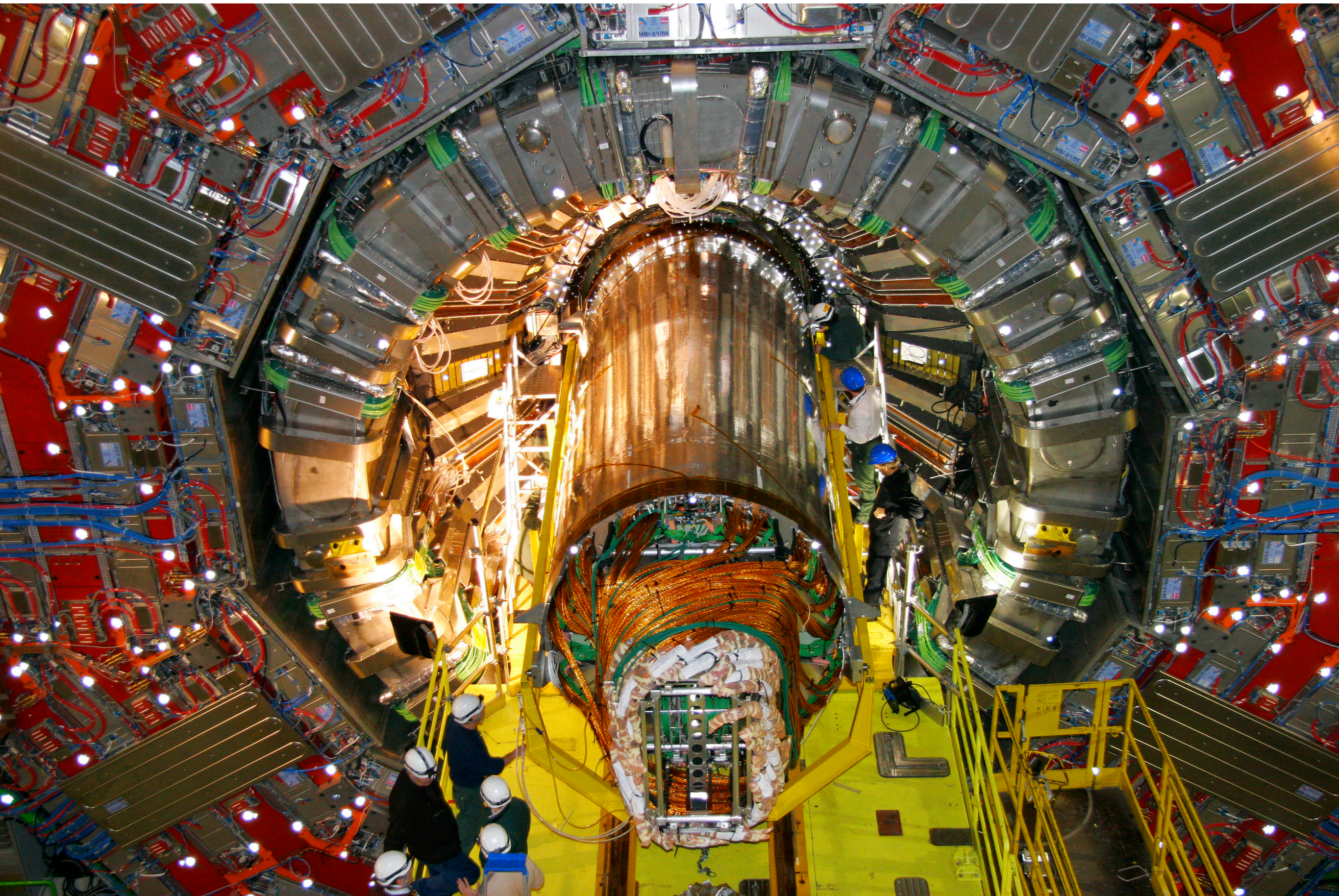

Beam Radiation Instrumentation Luminosity - BRIL

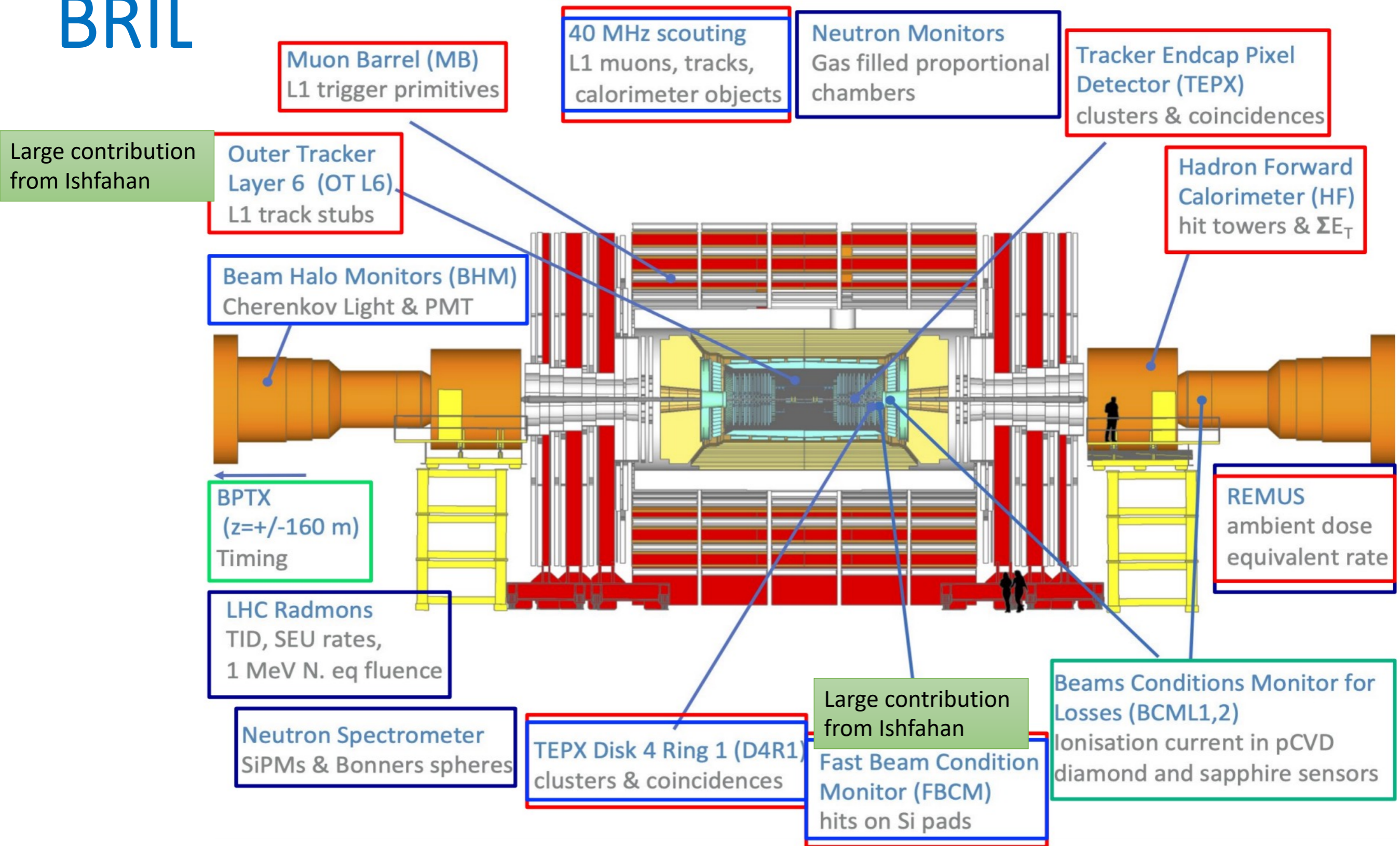

Wonderful opportunity to work on special, important but small detectors, where individuals can get significant visibility
And without it, CMS cannot run and physics would not be possible

Last but not least L1 Trigger

Select the good stuff, as you simply cannot readout and store all events

L1 Trigger is becoming even more intelligent

- Increased data & processing
 - ≥ 50 Tbps input; 40MHz; 12.5 μ s latency, accept rate 750 kHz
 - Barrel Calorimeter: 25x resolution improvement
 - Tracking information: **new** objects available
 - Endcap Calorimeter: 3D High Granularity

→ Particle Flow @ L1

→ Machine Learning

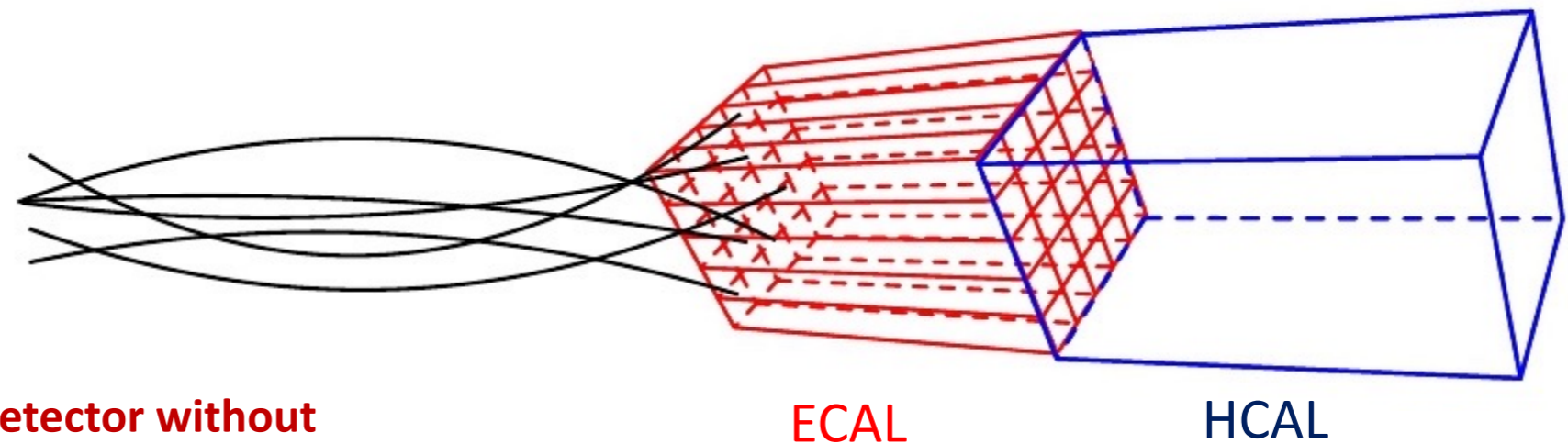
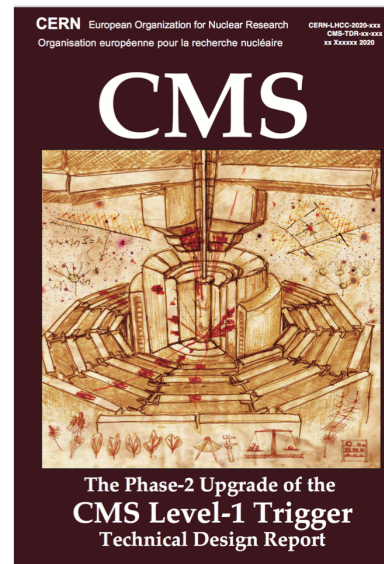
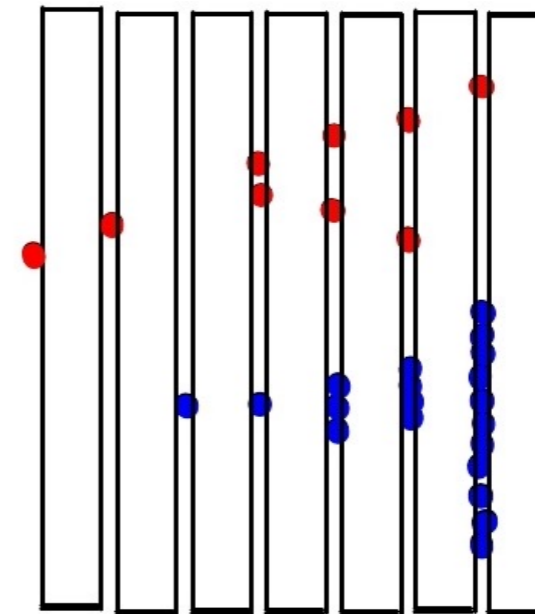

No need to improve resolution of detector without improving resolution at trigger level \sim thresholds

ECAL

HCAL

Then are the side-dishes that fewer people talks about

- Buildings, CO₂-cooling, gas distribution, power, safety, databases, service installation (power, fibers, pipes), systems to commissioning (quite cold), Data Acquisition, firmware, control systems, opening and closing 600t-objects, alignment
- Custom chips, custom electronics boards, custom optical transmitters/receivers
- Computing – neural network, machine learning

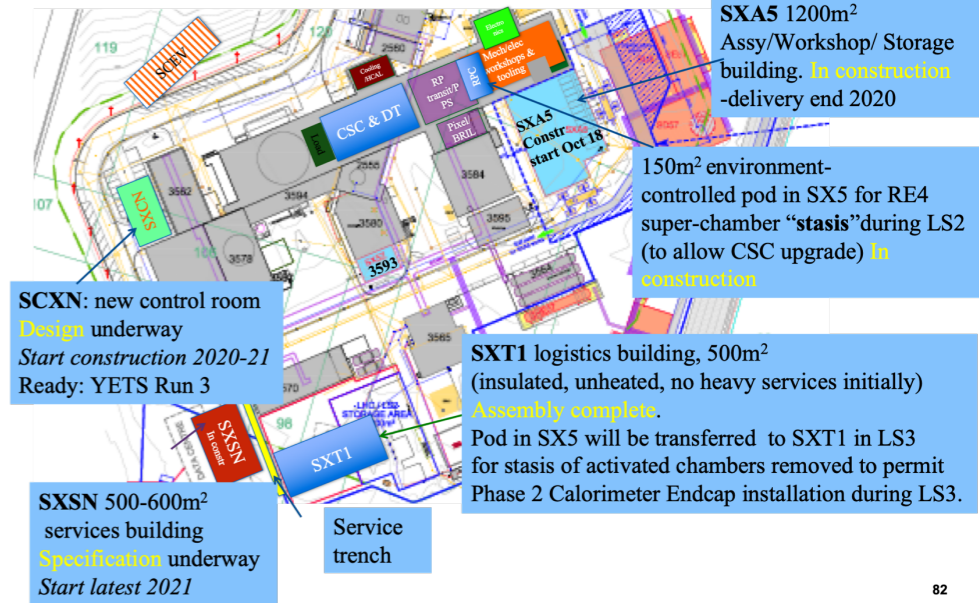

To surface storage and main chiller
Via PM 54 shaft (85m)

CO2 plants

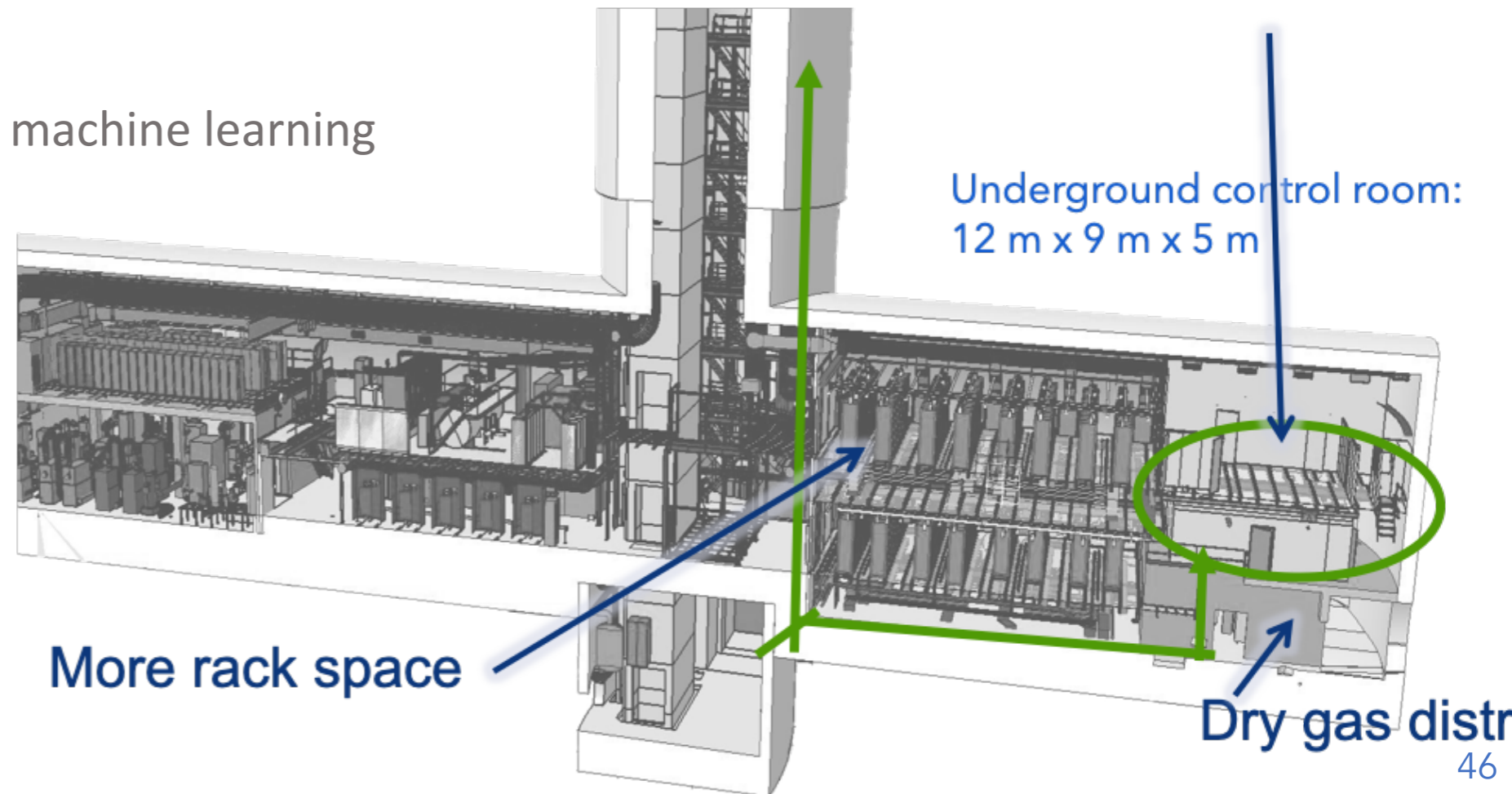

Space in the cavern is even more scarce then money

Now the Quiz

- Why are we doing this?
 - **To measure the hell out of these crazy phenomena!**
- What are the real new technologies?
 - Track Trigger
 - High Granularity Calorimeter
 - Particle Flow @ L1
 - 'Precision Timing'
- Is it fun?
 - **Oh YES! a fantastic tool**

I stop with a realistic illustration of the fun for the next several years

