

INTEGRATION OF FCC-EE RF SECTIONS

FCC-ee Underground Structure Overview

FCC-ee Machine tunnel Layout

FCC-ee RF/Cryogenic Layout

- *FCC-ee RF/Cryogenic Layout point L*

FCC-ee Underground Structure point L

- *FCC-ee RF Machine tunnel cross sections*
- *FCC-ee Klystron Gallery cross sections*
- *FCC-ee Underground structure Isometric views*

FCC-ee RF/Cryogenic Layout

- *FCC-ee RF/Cryogenic Layout point H*

FCC-ee Underground Structure point H

- *FCC-ee RF Machine tunnel cross sections*
- *FCC-ee Klystron Gallery cross sections*
- *FCC-ee Underground structure Isometric views*

FCC-ee Underground Structure Overview

Only schematic, and not to scale.

- █ FCC Tunnels
- █ Experimental points
- █ Access points
- █ Service caverns
- █ Connection tunnels
- █ Electrical alcoves
- █ Klystron galleries
- █ Tunnel widening
- █ Cryo cavern
- █ LHC

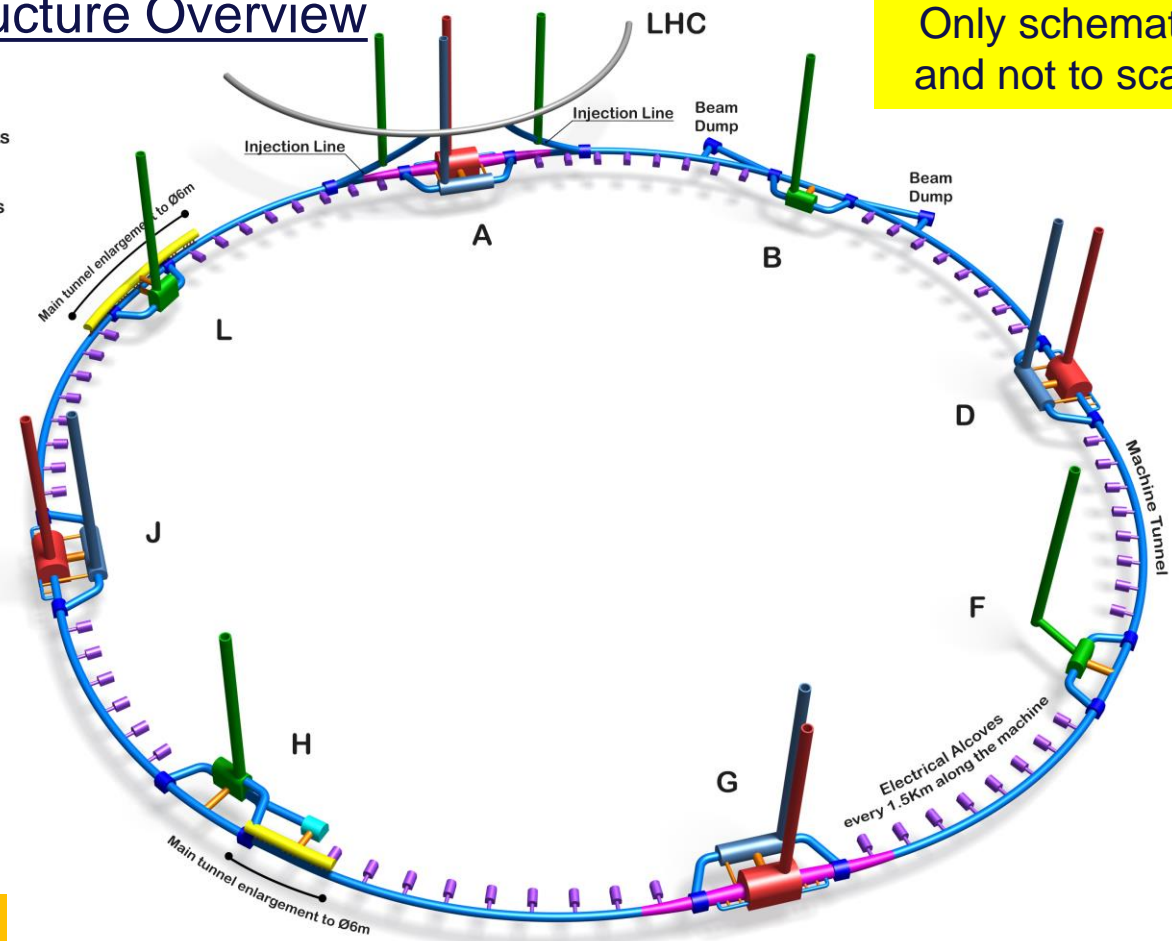

Courtesy A. Navascues Cornago

Integration of FCC-ee machine elements (regular arc)

Machine tunnel 5.5m in diameter

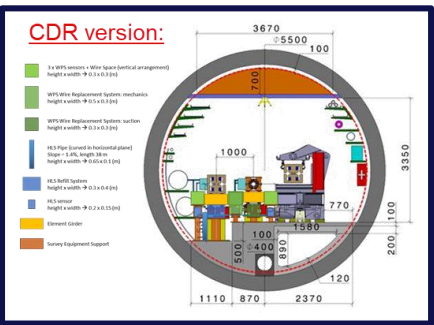
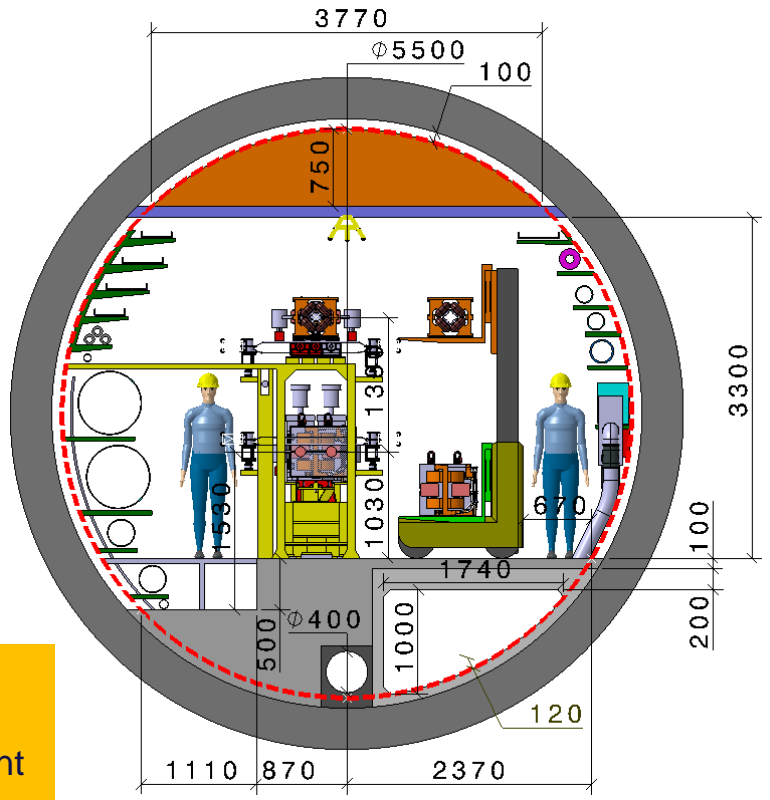
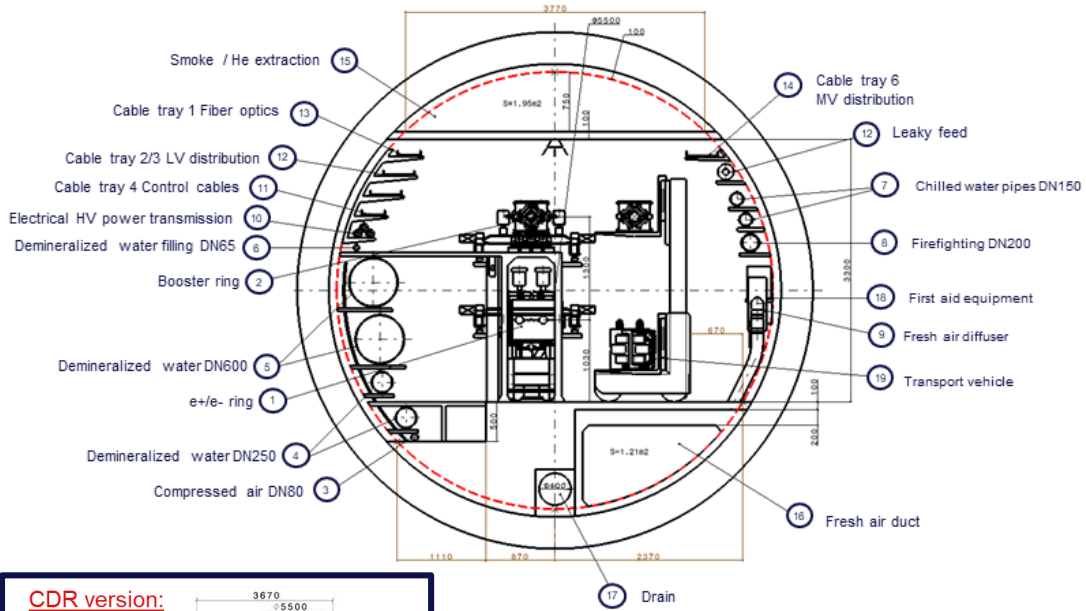

Main cross section as for FCC-hh
 Main ring below of booster ring
 Main ring and booster ring 1.3 m distant
 Water distribution changed

Collider Center



Integration of FCC-ee machine elements (regular arc)

Perspective view

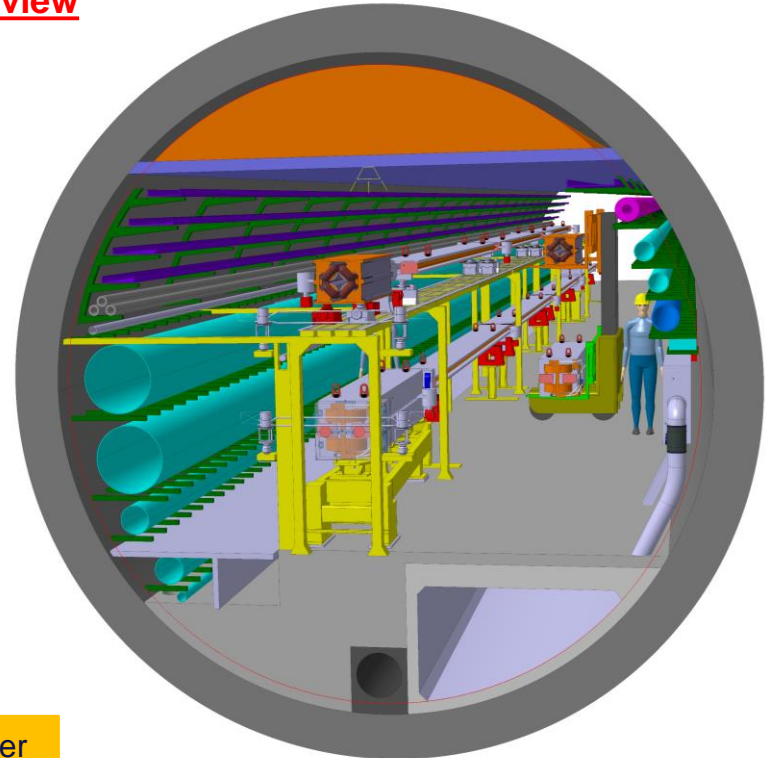
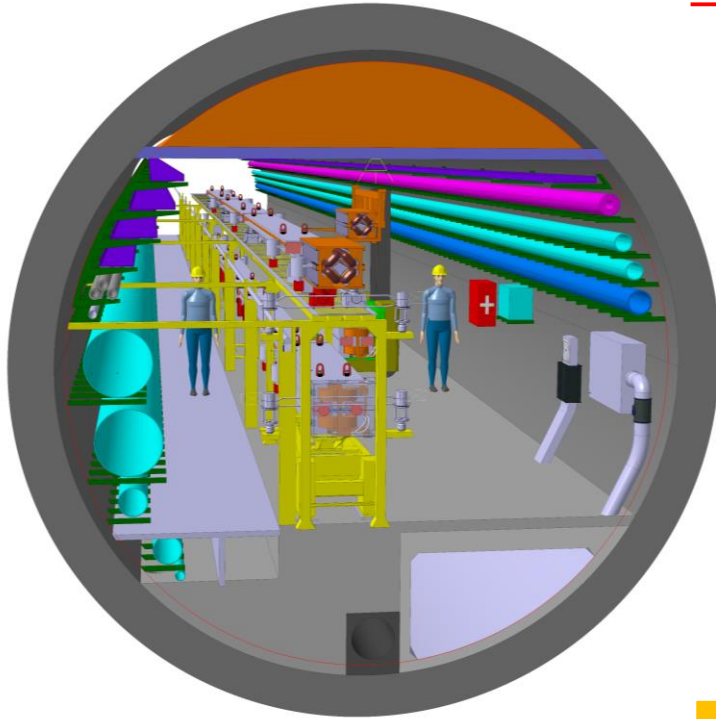

Collider Center



FCC-ee RF reference table

Courtesy F. Peauger and O. Brunner

24th May 2022	Z		W		H		ttbar2		
	per beam	booster	per beam	booster	2 beams	booster	2 beams	2 beams	booster
Frequency [MHz]	400	800	400	800	400	800	400	800	800
RF voltage [MV]	120	140	1000	1000	2480	2480	2480	9190	11670
Eacc [MV/m]	5.72	6.23	11.91	24.26	11.82	25.45	11.82	24.52	25.11
# cell / cav	1	5	2	5	2	5	2	5	5
Vcavity [MV]	2.14	5.83	8.93	22.73	8.86	23.85	8.86	22.98	23.53
#cells	56	120	224	220	560	520	560	2000	2480
# cavities	56	24	112	44	280	104	280	400	496
# CM	14	6	28	11	70	26	70	100	124
T operation [K]	4.5	2	4.5	2	4.5	2	4.5	2	2
dyn losses/cav [W]	19	0.5	174	7	171	8	171	51	8
stat losses/cav [W]	8	8	8	8	8	8	8	8	8
Qext	6.6E+04	3.2E+05	1.2E+06	8.9E+06	1.5E+06	1.2E+07	8.3E+06	4.9E+06	5.3E+07
Detuning [kHz]	8.939	4.393	0.430	0.115	0.123	0.031	0.025	0.040	0.005
Pcav [kW]	880	205	440	112	352	95	62	207	20
rhob [m]	9937	9937	9937	9937	9937	9937	9937	9937	9937
Energy [GeV]	45.6	45.6	80.0	80.0	120.0	120.0	182.5		182.5
energy loss [MV]	38.49	38.49	364.63	364.63	1845.94	1845.94	9875.14		9875.14
cos phi	0.32	0.27	0.36	0.36	0.74	0.74	0.70	0.90	0.85
Beam current [A]	1.280	0.128	0.135	0.0135	0.0534	0.005	0.010	0.010	0.001

FCC-ee RF 400 MHz Cryomodules space occupation

Courtesy V.Parma/E. Montesinos

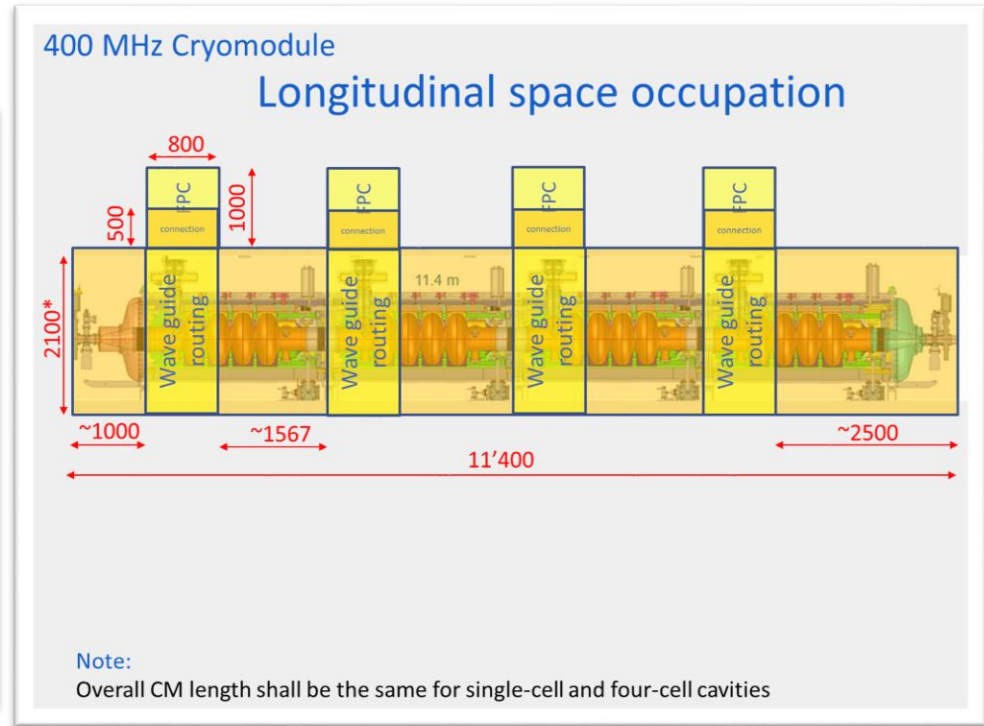
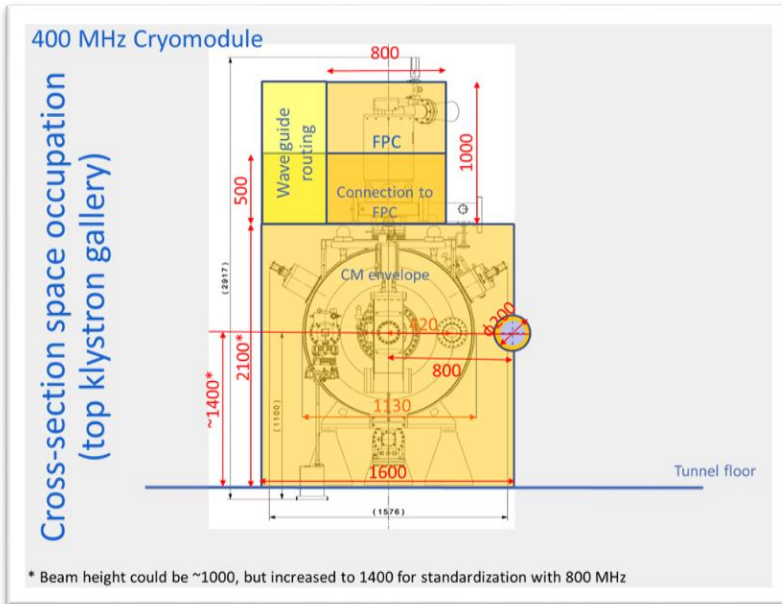

- Consider only 2 types of CM
- Same CM design for 1_cells (Z) and 2_cells (W, H) 400 MHz systems – distance between WG must remain constant
- The use of half-height WG may allow to reduce the number of WG holes – to be studied in detail

FCC-ee RF 800 MHz Cryomodules space occupation

Courtesy V.Parma/E. Montesinos

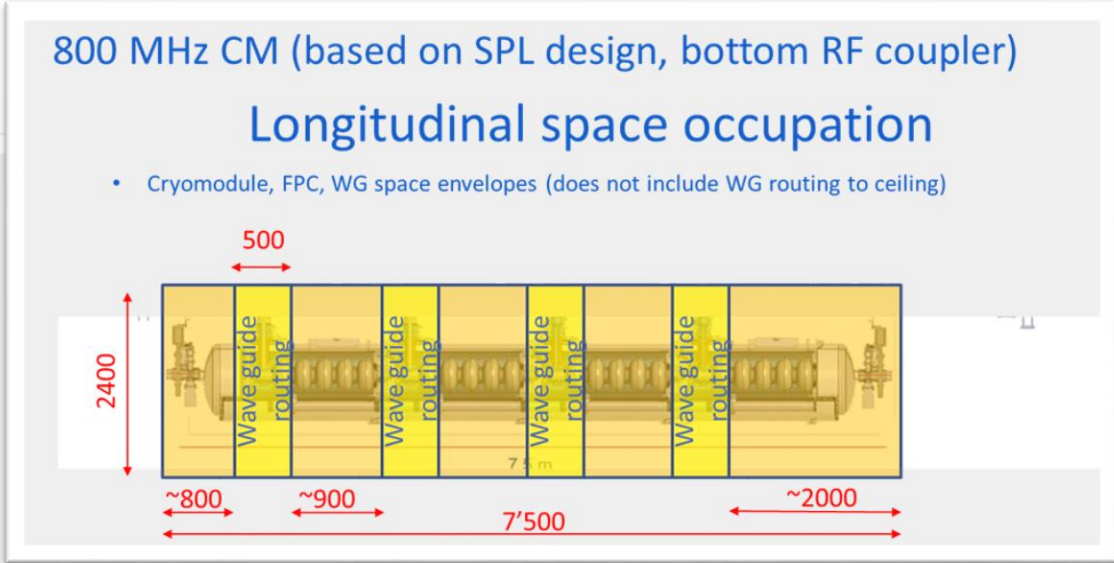
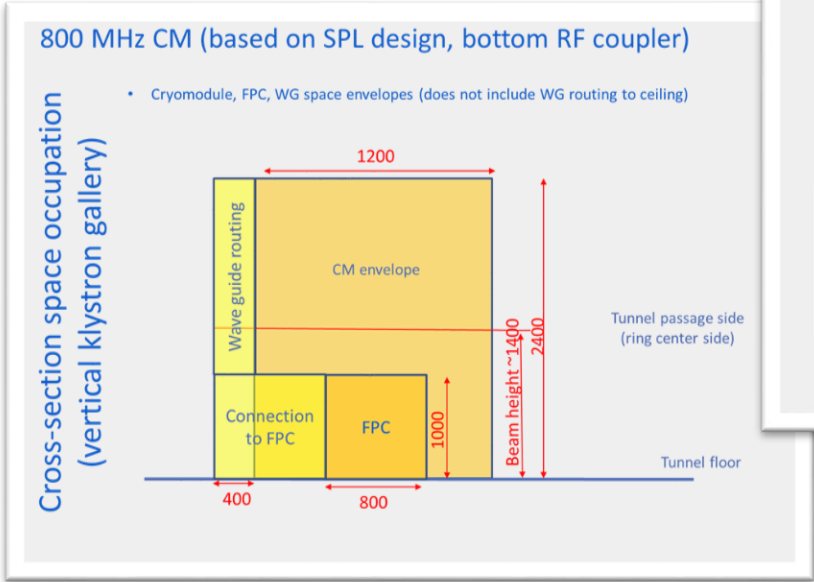

The use of half-height WG may allow to reduce the number of WG holes – to be studied in detail

FCC-ee RF/Cryogenic Layout point L

Courtesy L.Delprat, B.Bradu and K.Brodzinski

FCC-ee cryoplants and electrical power update

Point L	Z	W	H	ttbar
# of cryoplants	1	1	1	2
Installed capacity @ 4.5K (per cryoplant)	6 kW	60 kW	75 kW	75 kW
Included capacity @ 2K (per cryoplants)	0.5 kW	0.9 kW	2.2 kW	11 kW
Nominal elec. Power (in Total for point L)	1.3 MW	12.6 MW	15.8 MW	31.5 MW

Point L cryogenic layout (ttbar)

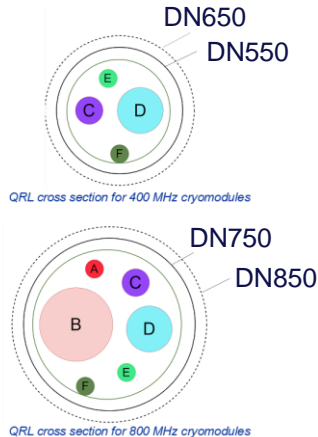
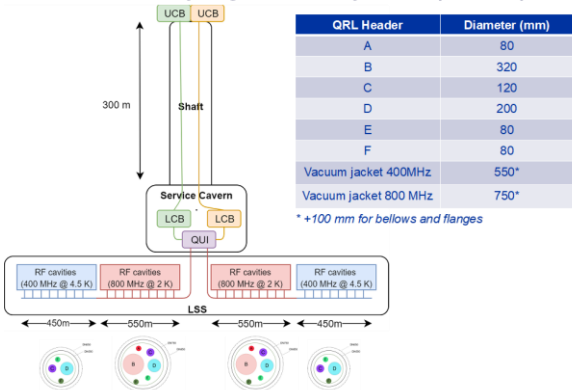

TLSS length: 2160 m

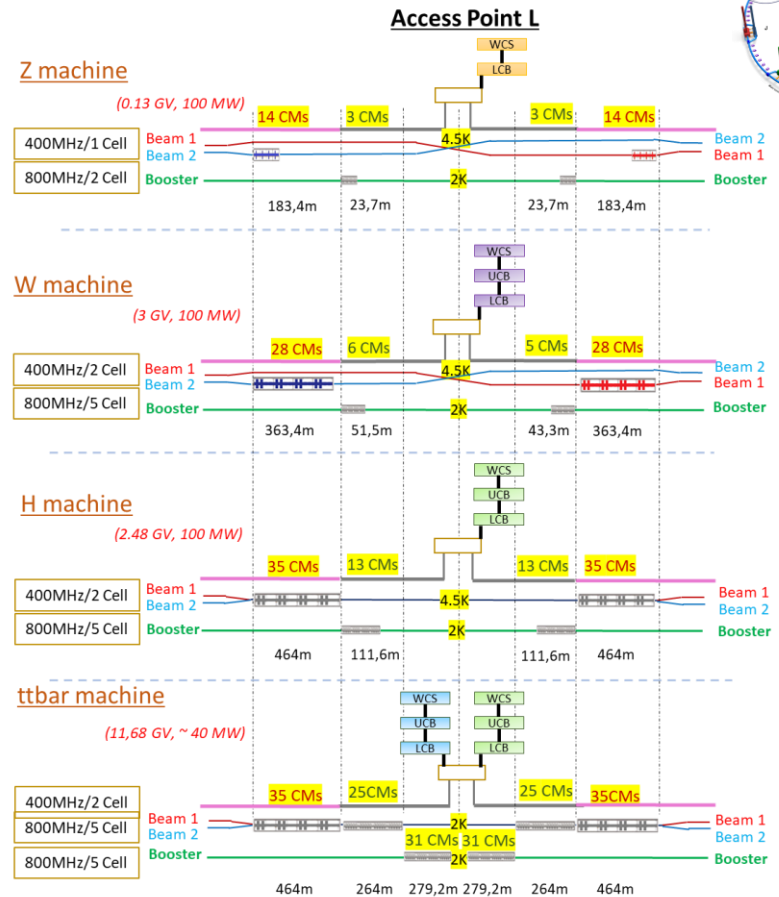
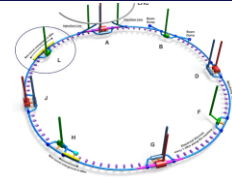

2K RF Booster CMs near to cryoplants then 4.5K Collider CMs

TOTAL RF LENGTH: 2014,4 m

FCC-ee RF Machine tunnel cross section (Z,W,H machine)

- e⁺e⁻ beam separation 0.8 m (needs quadrupole (model) with that spacing).
- QRL Ø along 400 MHz section 0.65 m.
- Distance between e⁺e⁻ quadrupoles 52 m, length 3.1 m.
- Distance between booster quadrupoles 52 m, length 1.5 m.

Machine tunnel 6 m in diameter

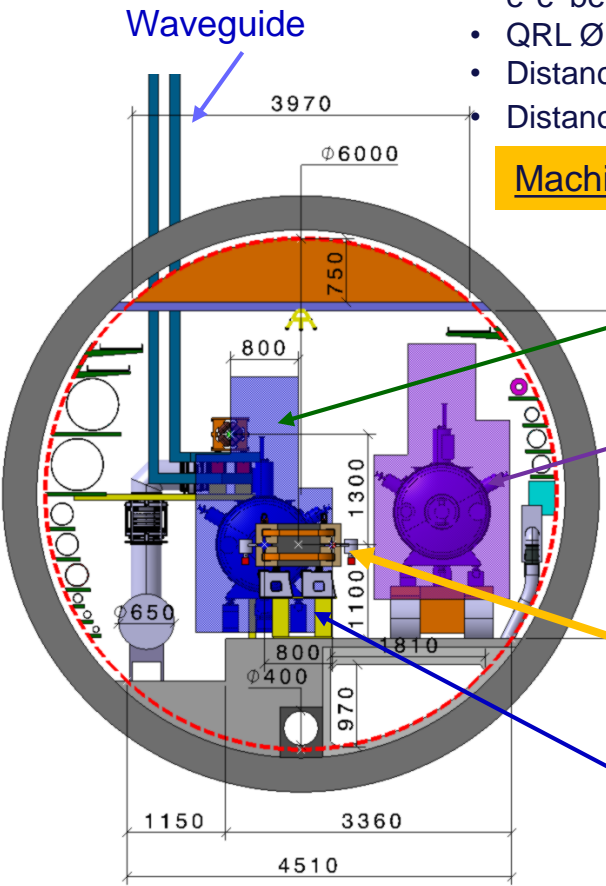

Collider ring
Cryomodule 400 MHz

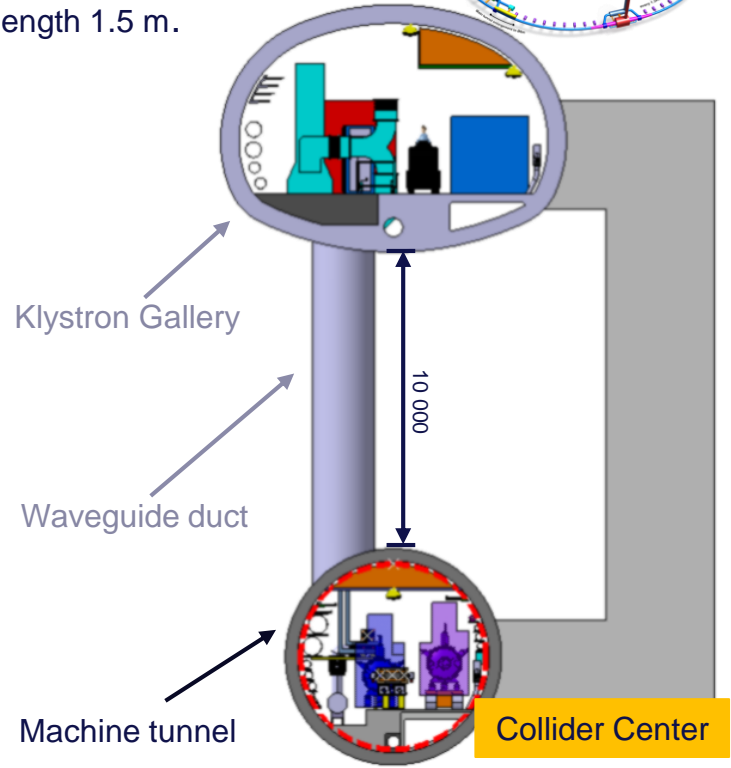
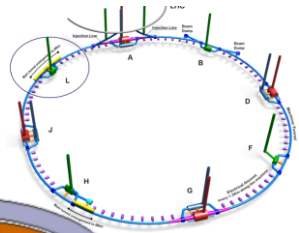

Klystron Gallery

Waveguide duct

Machine tunnel

Collider Center

FCC-ee RF Machine tunnel cross section (Z,W,H machine)

- e⁺e⁻ beam separation 0.8 m (needs quadrupole (model) with that spacing).
- QRL Ø along 400 MHz section 0.65 m.
- QRL Ø along 800 MHz section 0.85 m
- Distance between e⁺e⁻ quadrupoles 52 m, length 3.1 m.
- Distance between booster quadrupoles 52 m, length 1.5 m.

Machine tunnel 6 m in diameter

**Booster ring
Cryomodule 800 MHz**

Transport

**Need a new design of
Quadrupole magnet**

**Collider ring
Cryomodule 400 MHz**

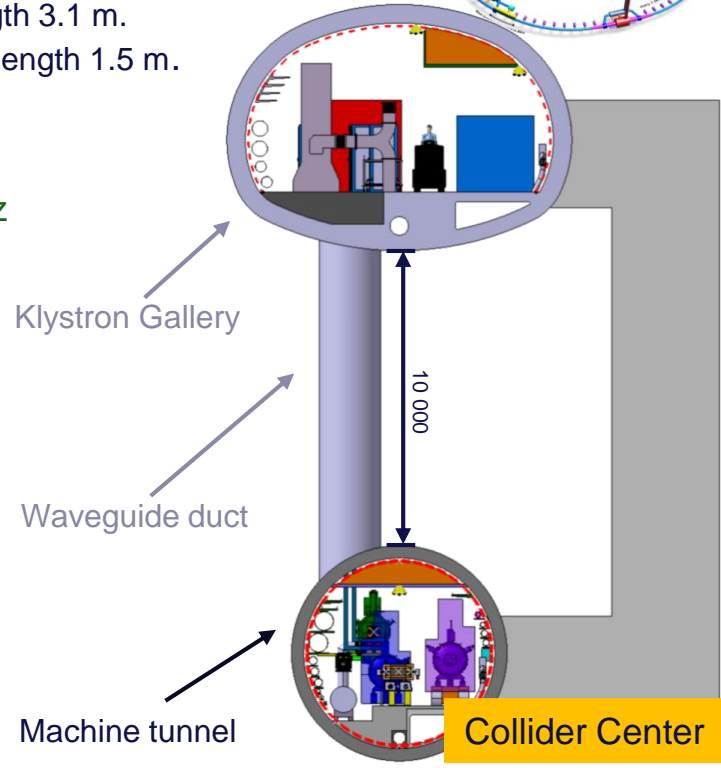
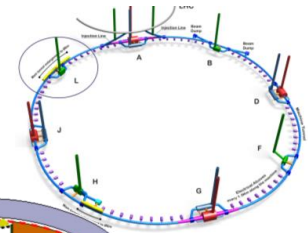
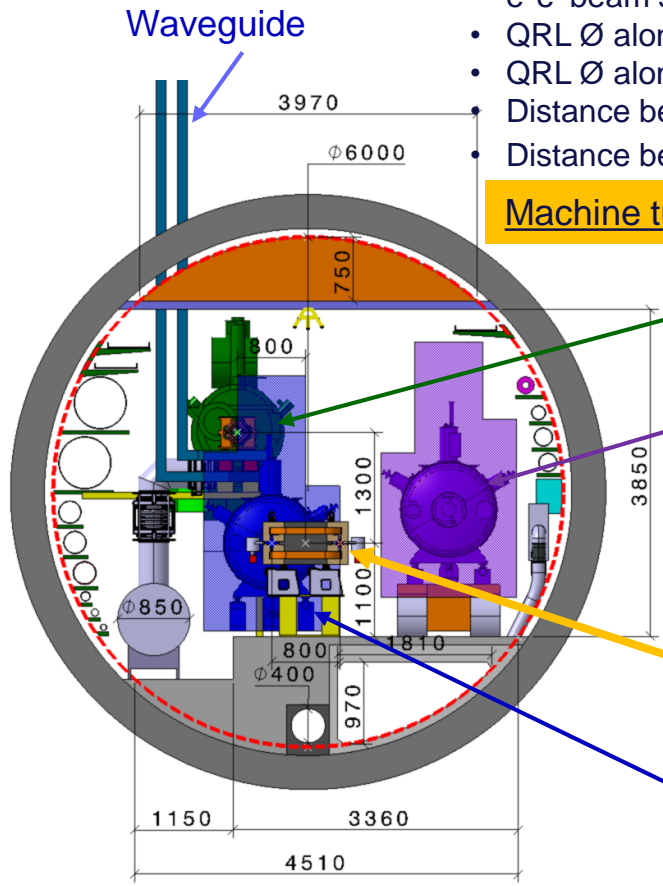

FCC-ee RF Machine tunnel cross section (ttbar machine)

- e⁺e⁻ beam separation 0.8 m (needs quadrupole (model) with that spacing).
- QRL Ø along 800 MHz section 0.85 m
- Distance between e⁺e⁻ quadrupoles 52 m, length 3.1 m.
- Distance between booster quadrupoles 52 m, length 1.5 m.

Machine tunnel 6 m in diameter

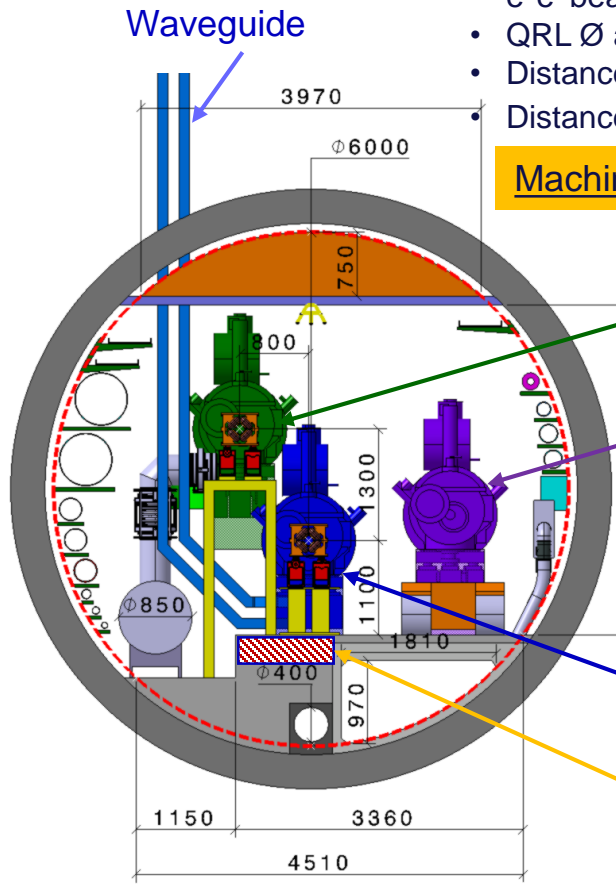

Booster ring
Cryomodule 800 MHz

Transport

Collider ring
Cryomodule 800 MHz

Concrete cut-out

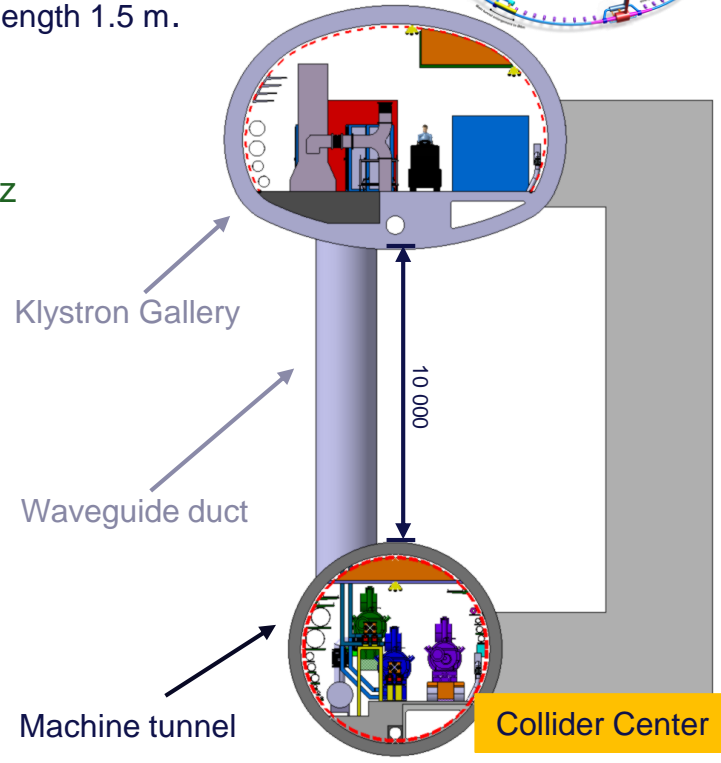
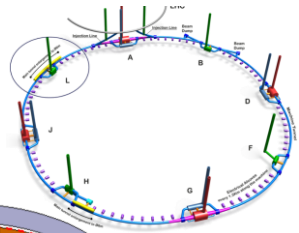

Klystron Gallery

Waveguide duct

Machine tunnel

Collider Center



FCC-ee RF Machine tunnel longitudinal view (ttbar machine)

- Distance between e^+e^- quadrupoles 52 m, length 3.1 m.
- Distance between booster quadrupoles 52 m, length 1.5 m.

800 MHz cryomodules (\varnothing 1.09 m x 7.5 m), half RF LSS

- 25 e^+e^- CM + 31 booster CM = 56 CM (543.2 m)
- 112 klystrons

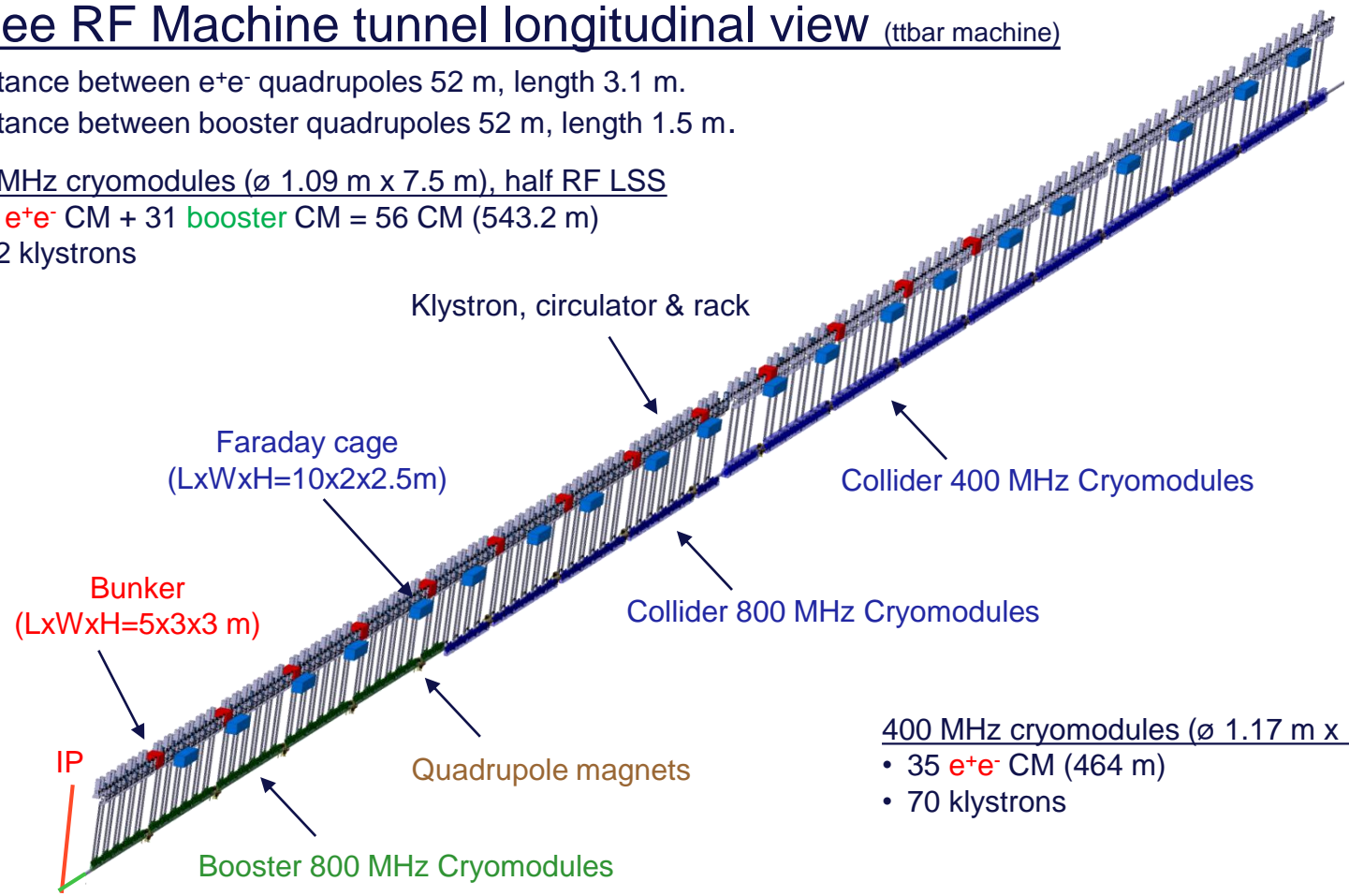
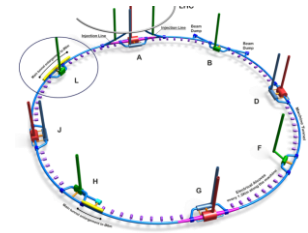

400 MHz cryomodules (\varnothing 1.17 m x 11.4 m), half RF LSS

- 35 e^+e^- CM (464 m)
- 70 klystrons

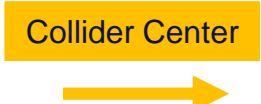

FCC-ee Underground Structure

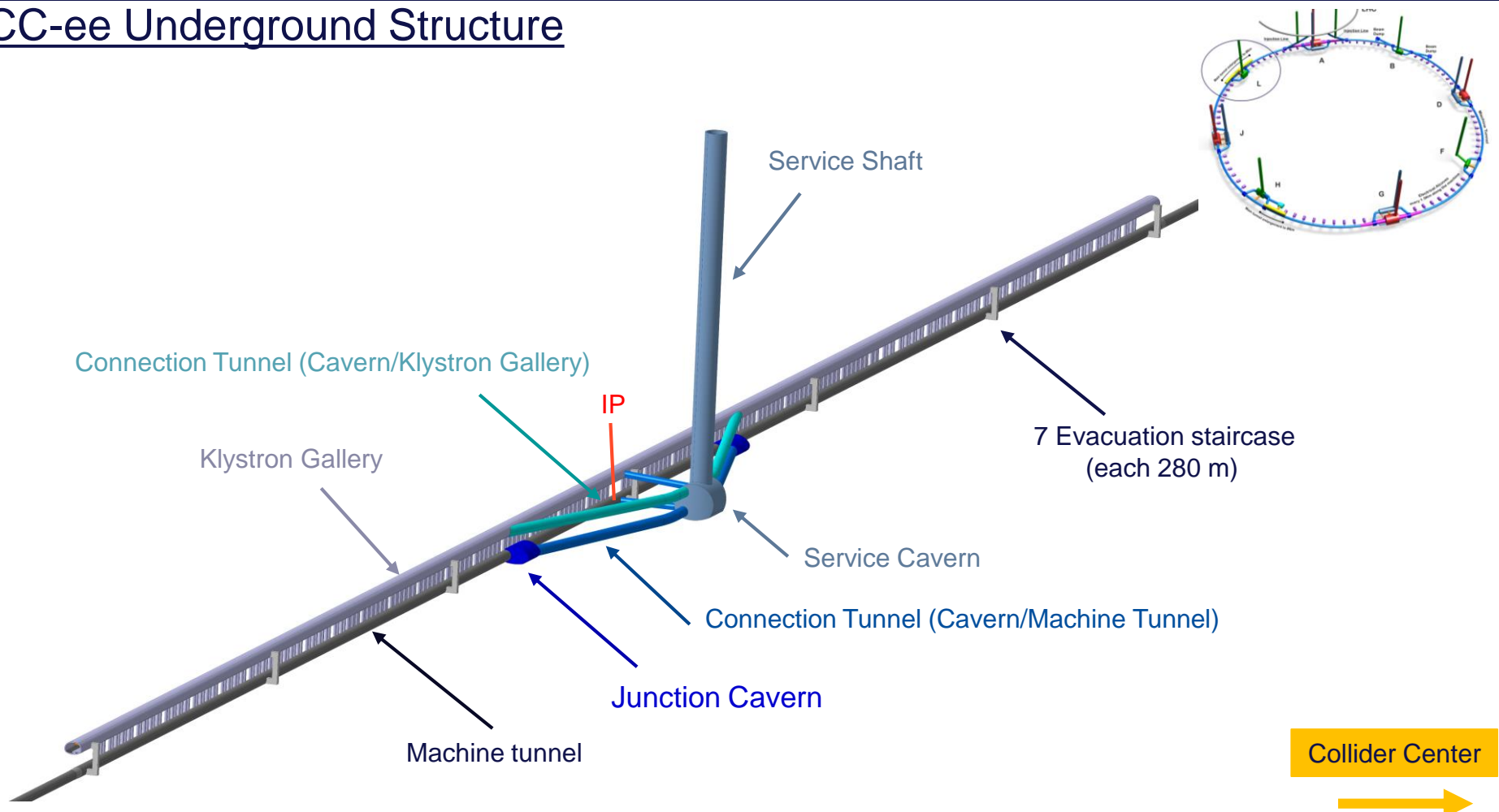

Collider Center
→

FCC-ee RF/Cryogenic Layout point H option 1

TLSS length: 2160 m

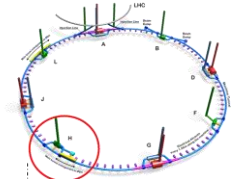

Courtesy L.Delprat, B.Bradu and K.Brodzinski

FCC-ee cryoplants and electrical power update

Point H	Z	W	H	ttbar
# of cryoplants				2
Installed capacity @ 4.5K (per cryoplant)				38 kW
Included capacity @ 2K (per cryoplants)	NO CRYO			
Nominal elec. Power (in Total for point H)				16 MW

Point H option 1: all cryo in a dedicated cavern at the LSS center

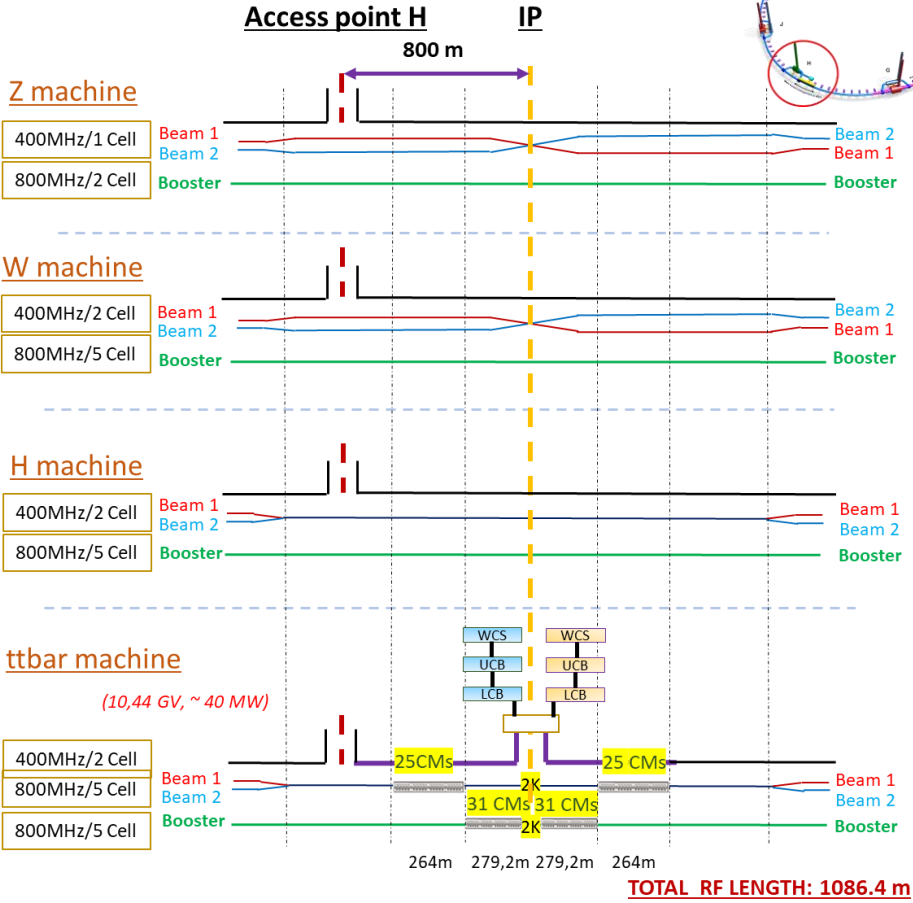
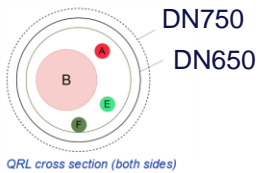
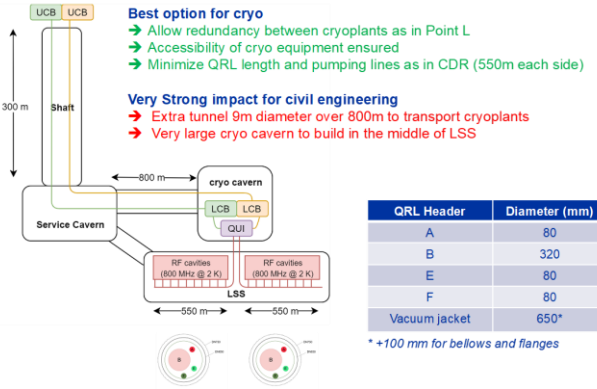

2K Booster CMs near to cryoplants

FCC-ee RF Machine tunnel cross section (ttbar machine) option 1

- QRL \varnothing along 800 MHz section 0.75 m.
- Distance between e⁺e⁻ quadrupoles 52 m, length 3.1 m.
- Distance between booster quadrupoles 52 m, length 1.5 m.

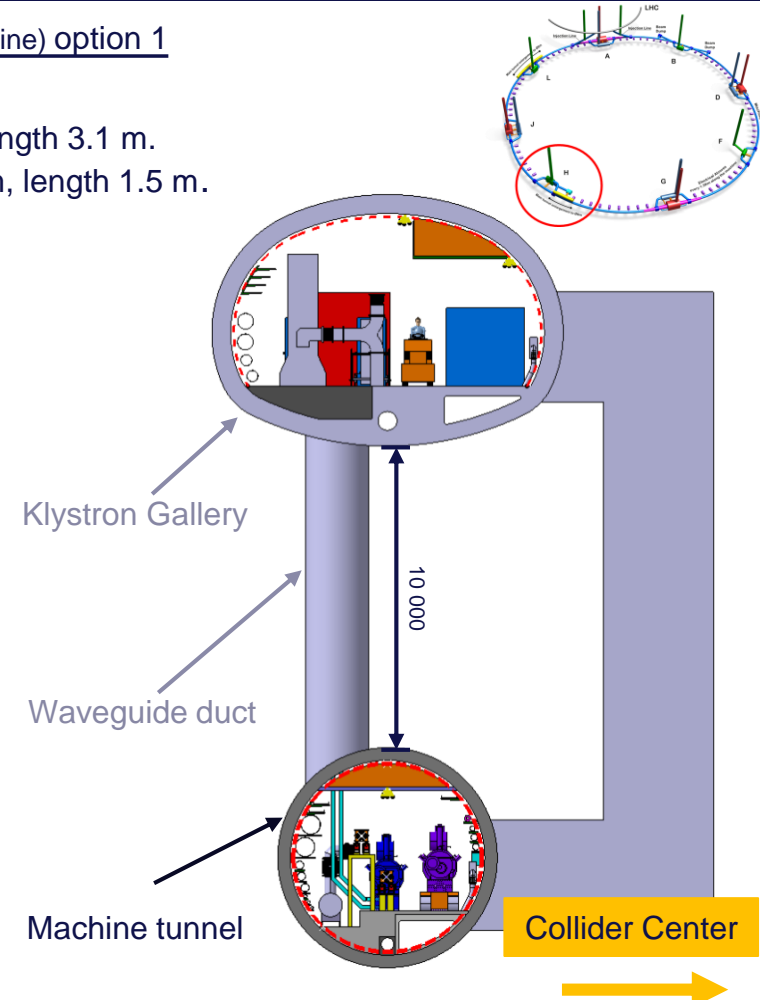
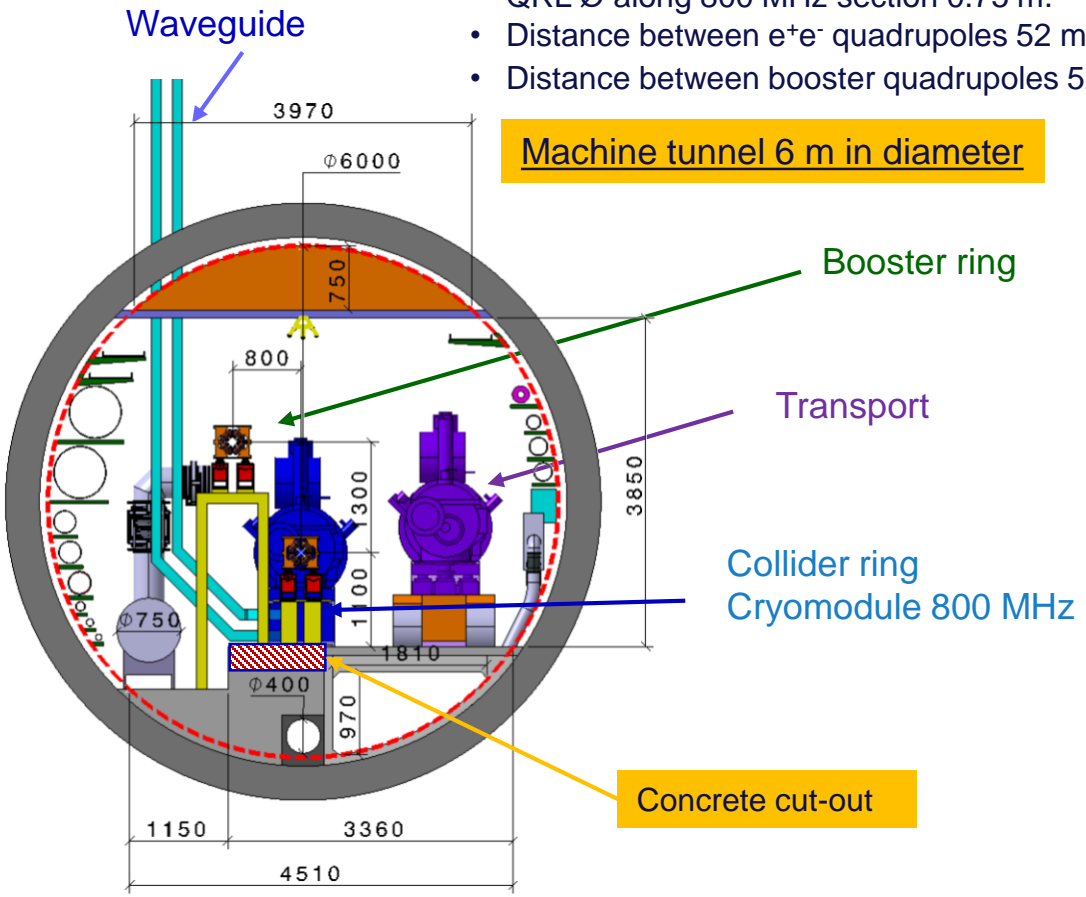

FCC-ee RF Machine tunnel cross section (ttbar machine) option 1

- QRL \varnothing along 800 MHz section 0.75 m.
- Distance between e⁺e⁻ quadrupoles 52 m, length 3.1 m.
- Distance between booster quadrupoles 52 m, length 1.5 m.

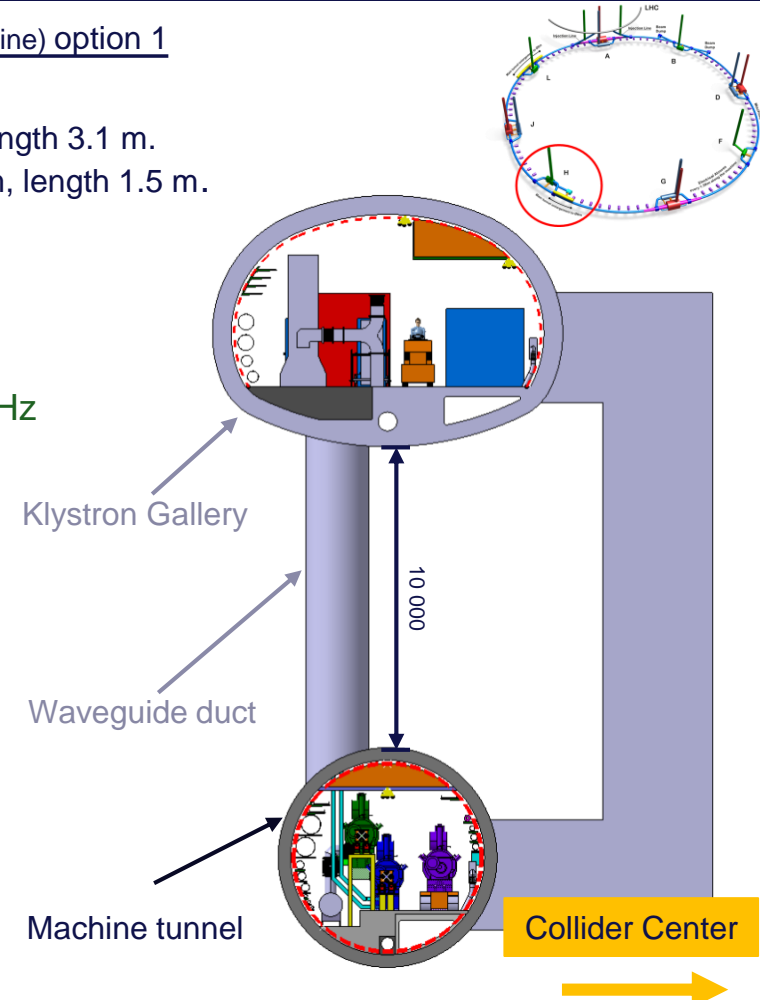
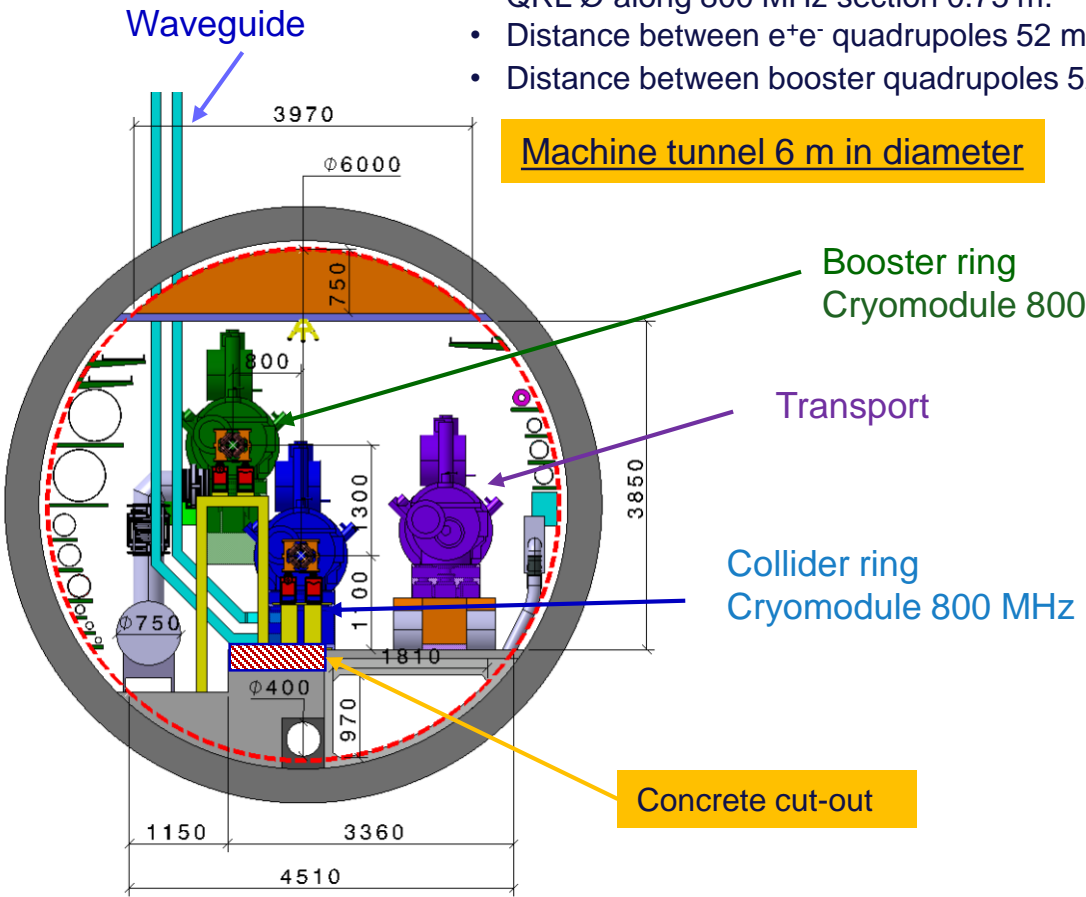

FCC-ee RF Machine tunnel longitudinal view (ttbar machine) option 1

- Distance between e⁺e⁻ quadrupoles 52 m, length 3.1 m.
- Distance between booster quadrupoles 52 m, length 1.5 m.

800 MHz cryomodules (ø 1.09 m x 7.5 m), half RF LSS

- 25 e⁺e⁻ CM + 31 booster CM = 56 CM (543,2 m)
- 112 klystrons

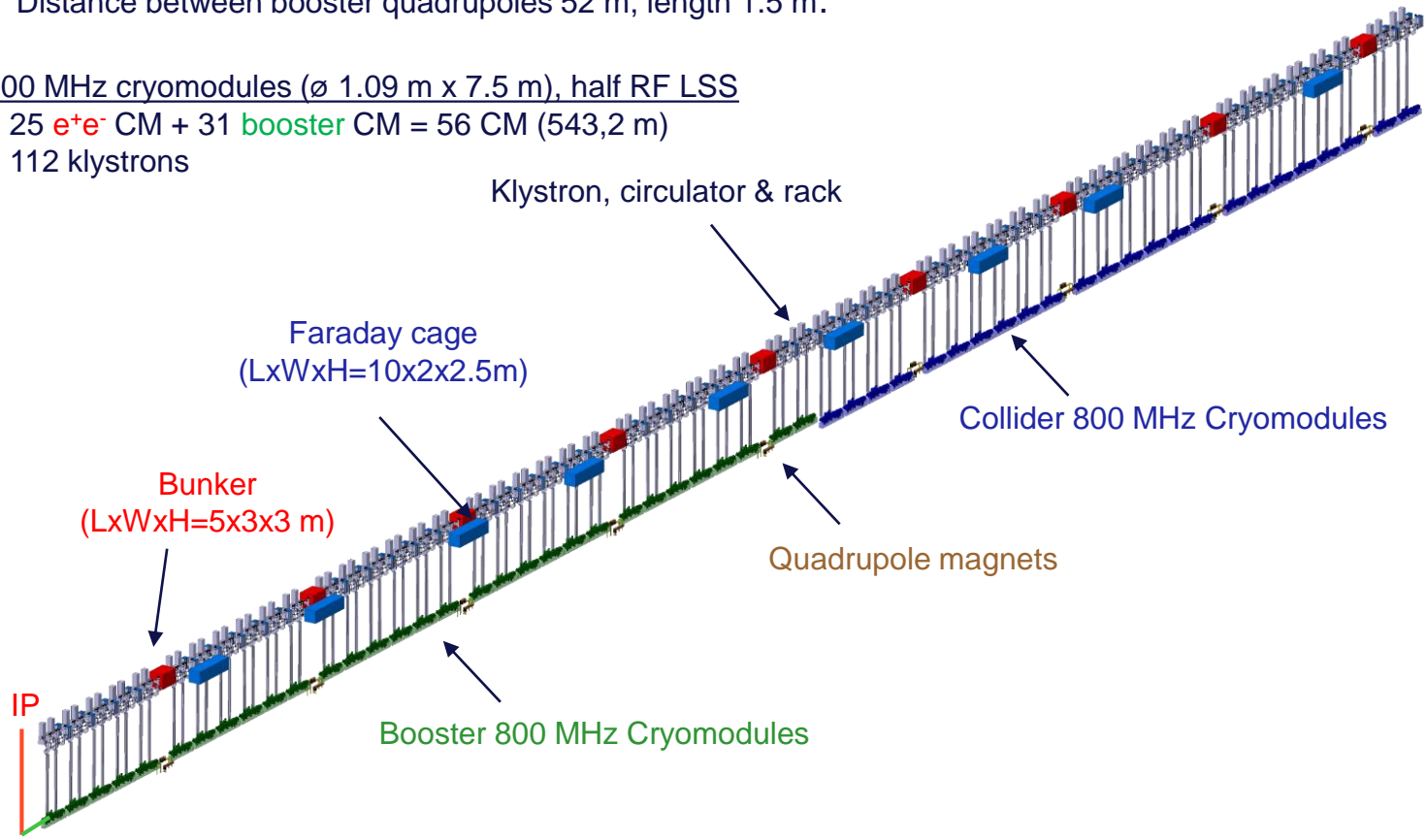
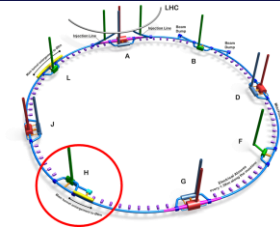

Collider Center



FCC-ee Underground Structure option 1

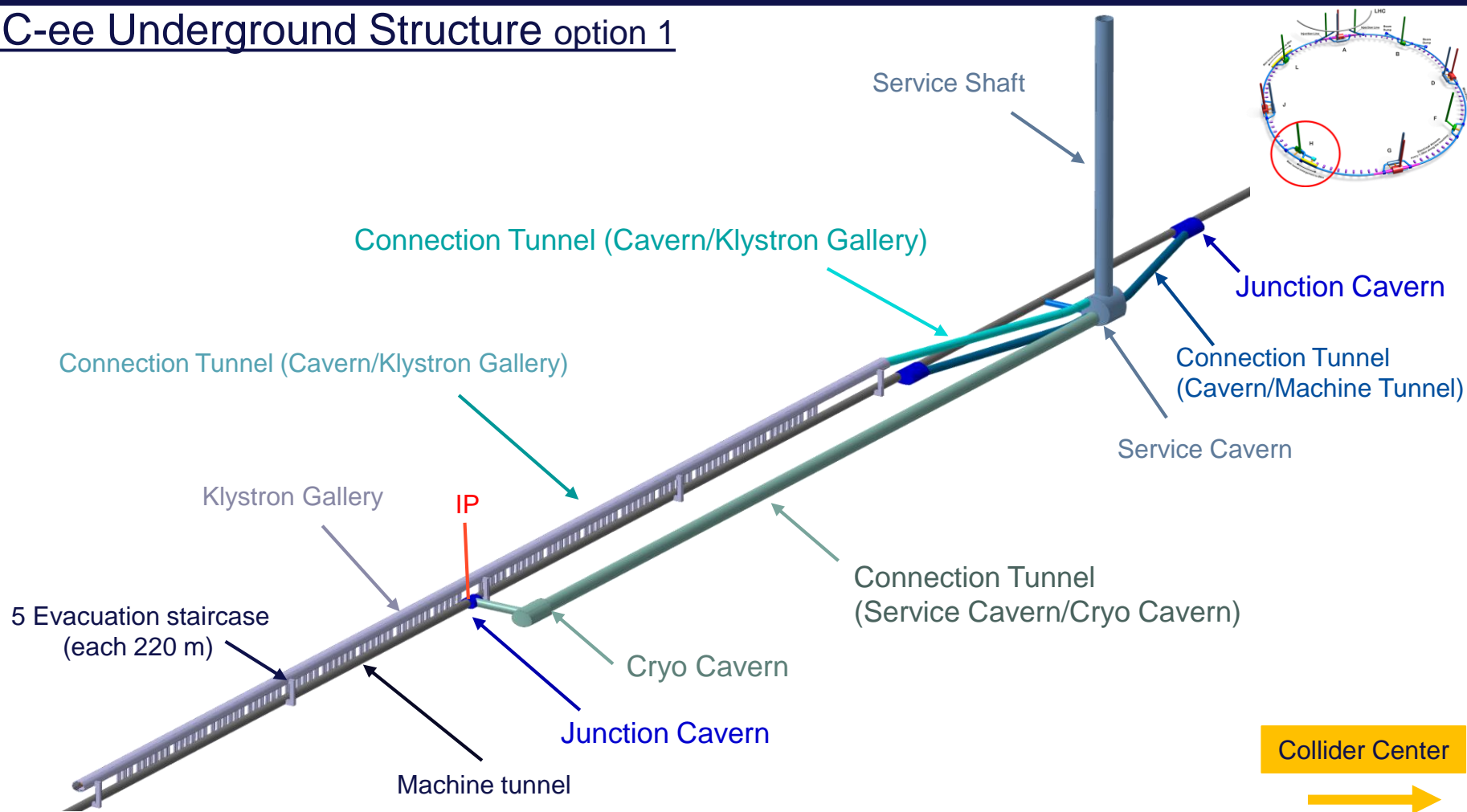

Conclusion

- For Z, W, H and ttbar machine all 400MHz Cryomodules will be housed at point L .
- For Z, W, H machine all 800MHz Cryomodules will be housed at point L .
- For ttbar machine 800MHz Cryomodules will be divided into point L and point H.

	Point L		Point H	
	400 MHz CMs	800 MHz CMs	400 MHz CMs	800 MHz CMs
Z machine	4.5K	2K	NO CMs	NO CMs
W machine	4.5K	2K		
H machine	4.5K	2K		
ttbar machine	4.5K	2K		

- RF machine tunnel will be 6m in diameter compared to machine tunnel in the regular arcs and other TLSS
- Integration study of RF scenarios and stages, selection of cavities and location of cryomodule, RF frequency and cryogenic temperature continue.
- Further work on the underground structure at point H with a view to deepening the needs in certain areas.



Thank you
for your attention.