

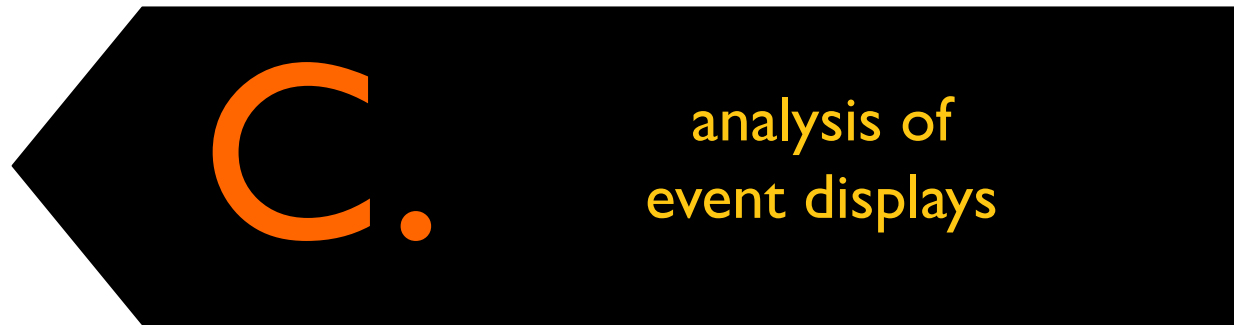

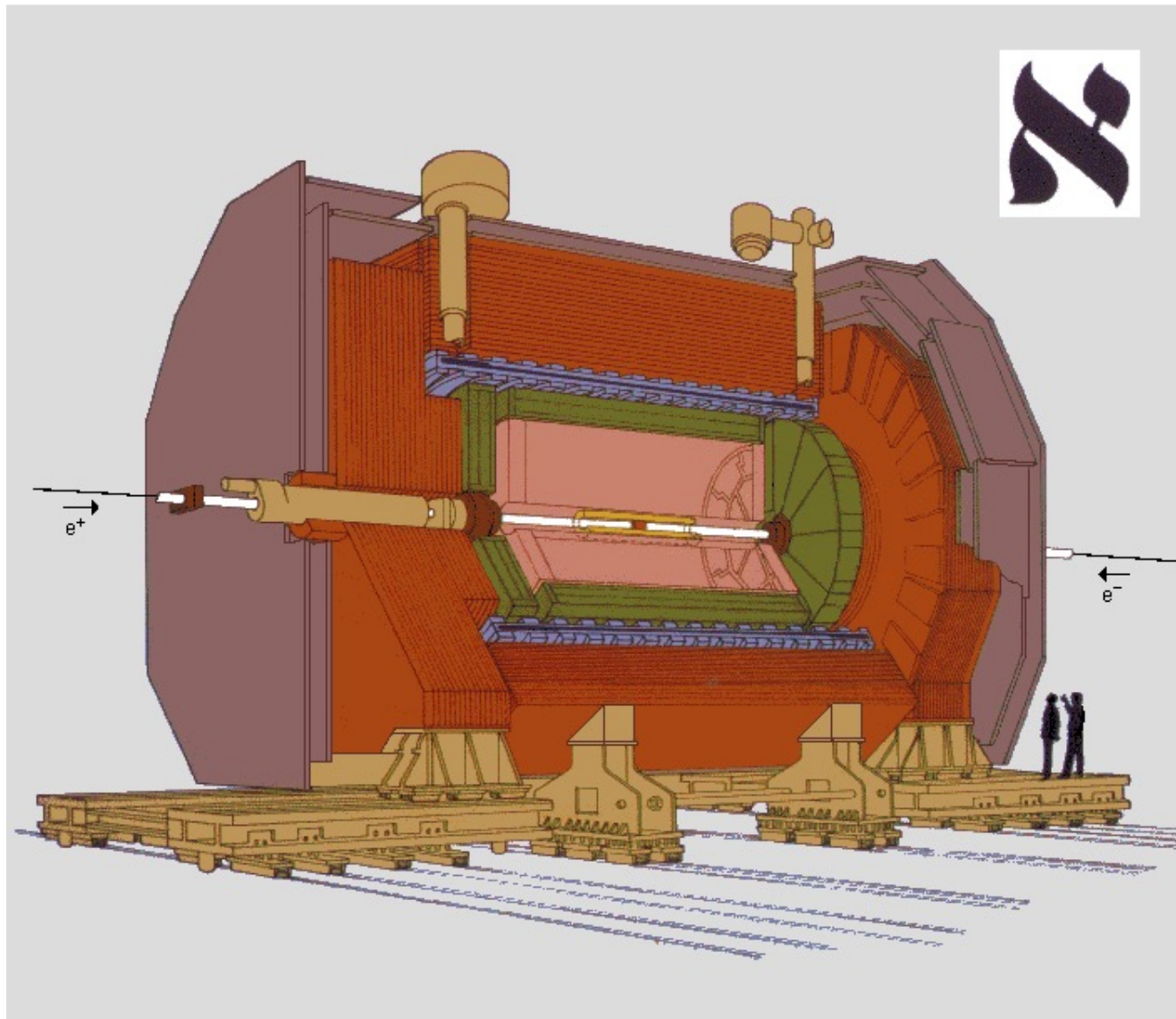





Experimental particle. physics

esipap...
European School of Instrumentation
in Particle & Astroparticle Physics





-  Vertex Detector
-  Inner Tracking Chamber
-  Time Projection Chamber
-  Electromagnetic Calorimeter
-  Superconducting Magnet Coil
-  Hadron Calorimeter
-  Muon Chambers
-  Luminosity Monitors

The ALEPH Detector

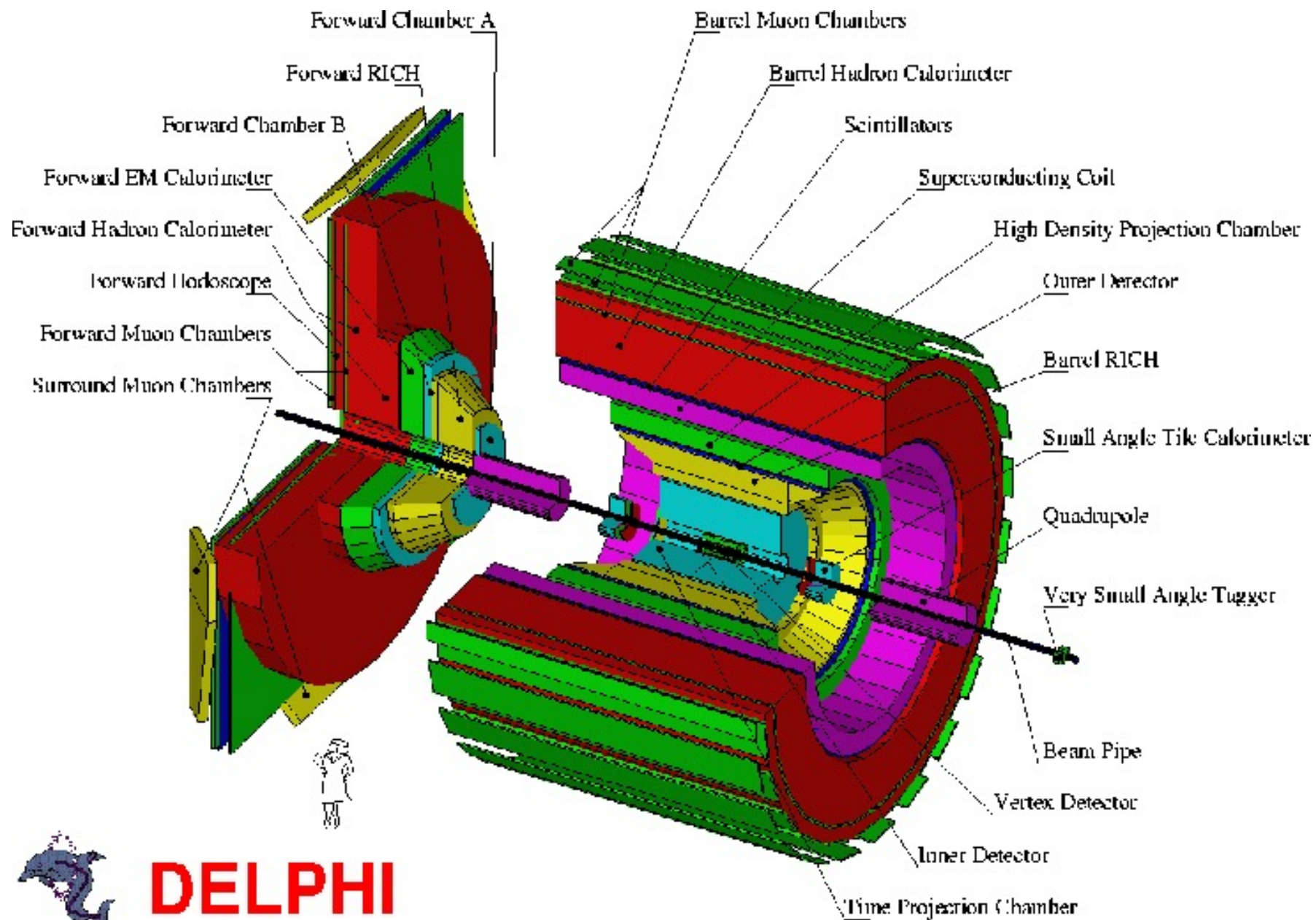

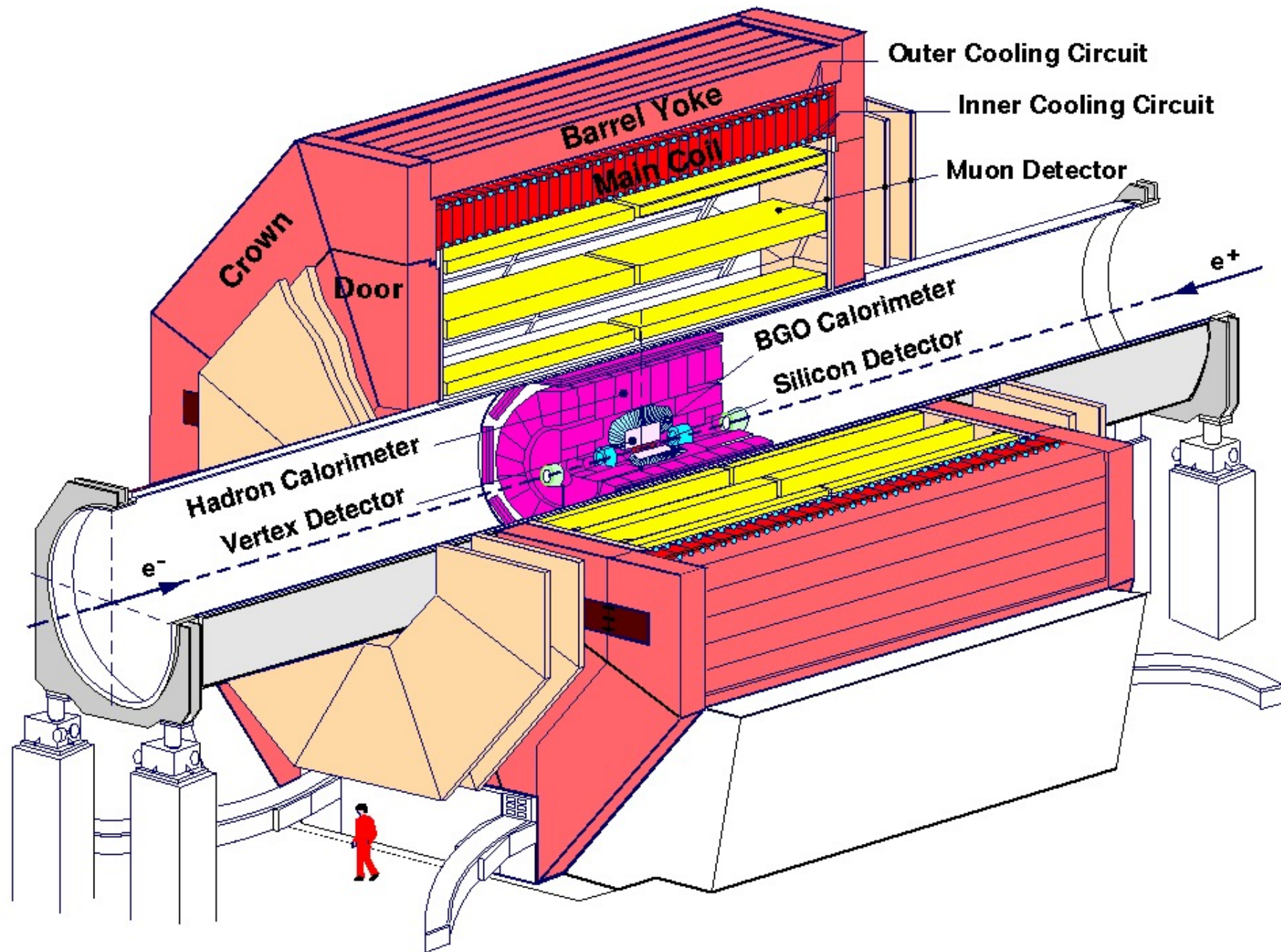

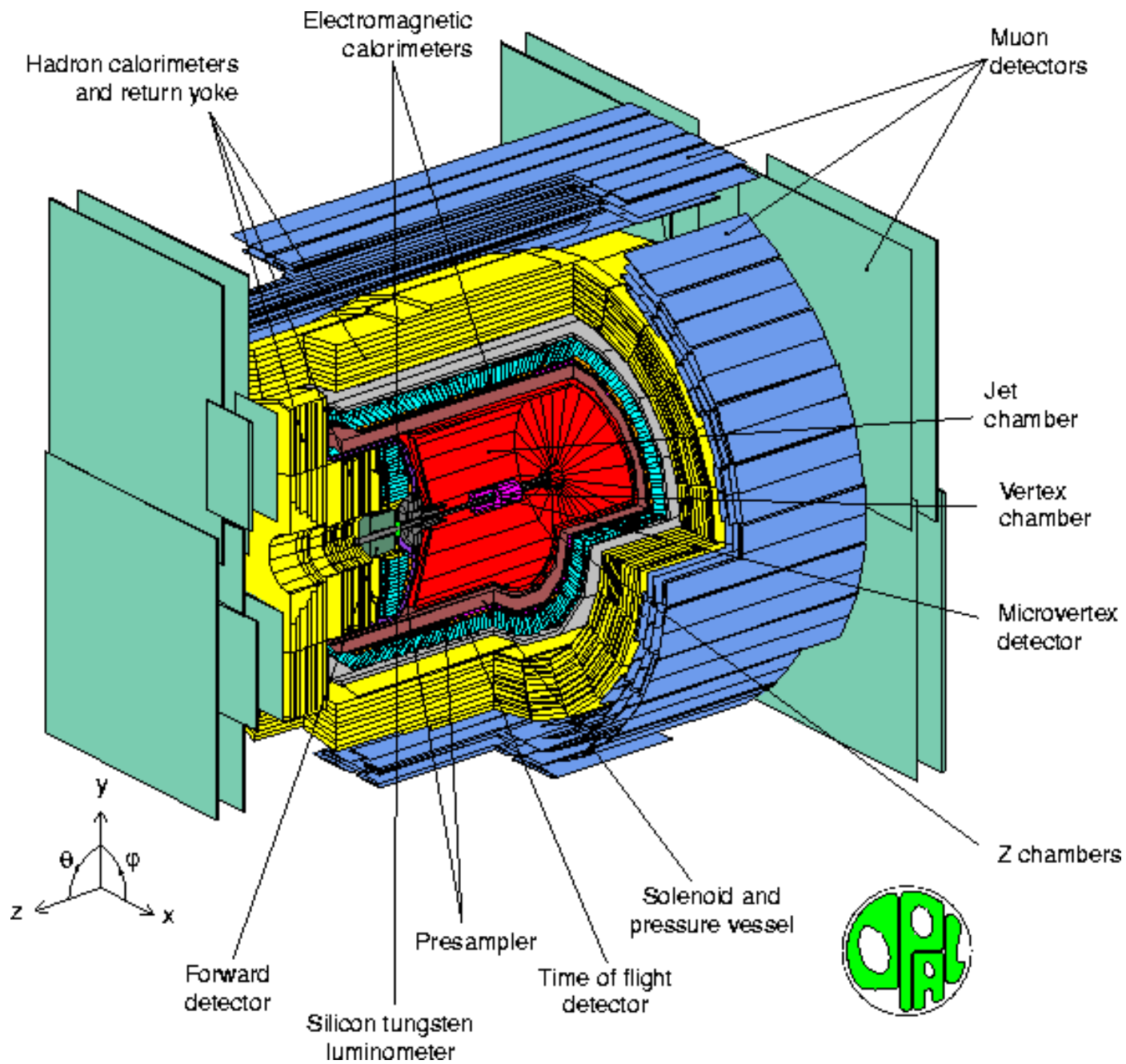

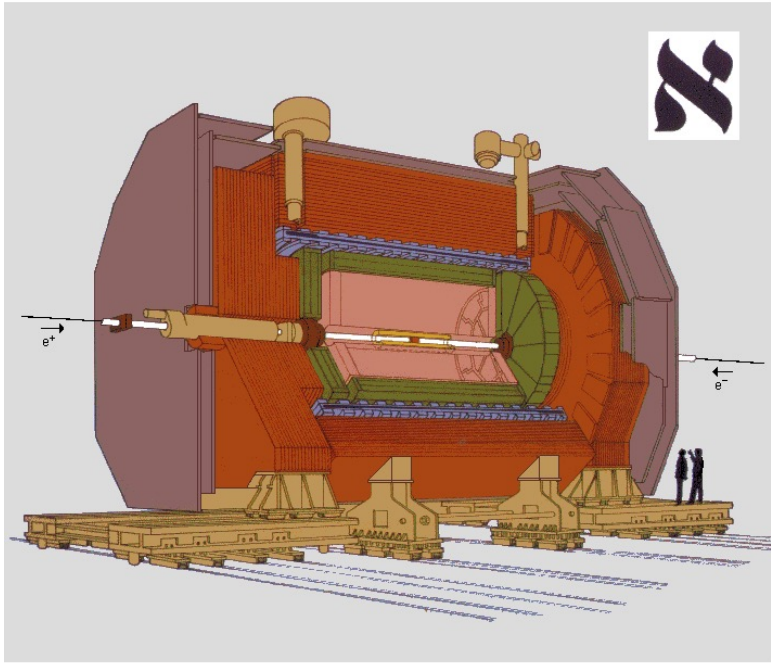

- Vertex Detector
- Inner Tracking Chamber
- Time Projection Chamber
- Electromagnetic Calorimeter
- Superconducting Magnet Coil
- Hadron Calorimeter
- Muon Chambers
- Luminosity Monitors

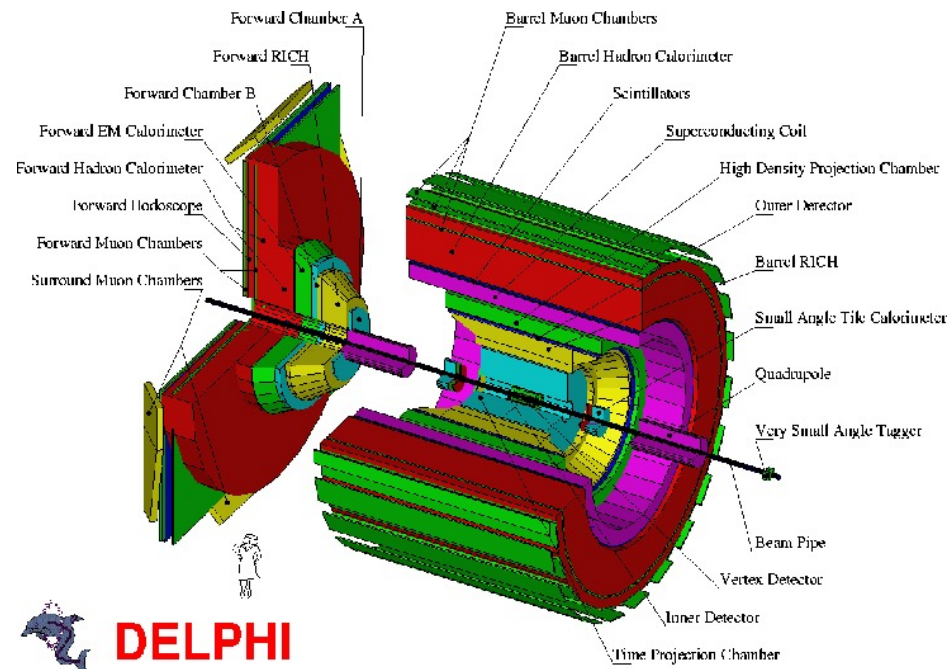

The ALEPH Detector

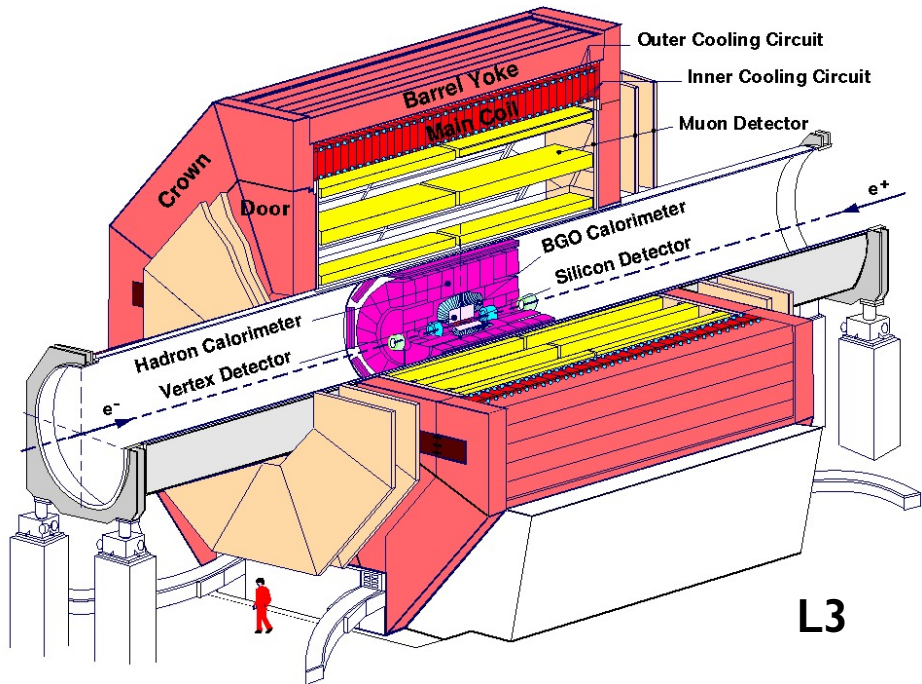

L3

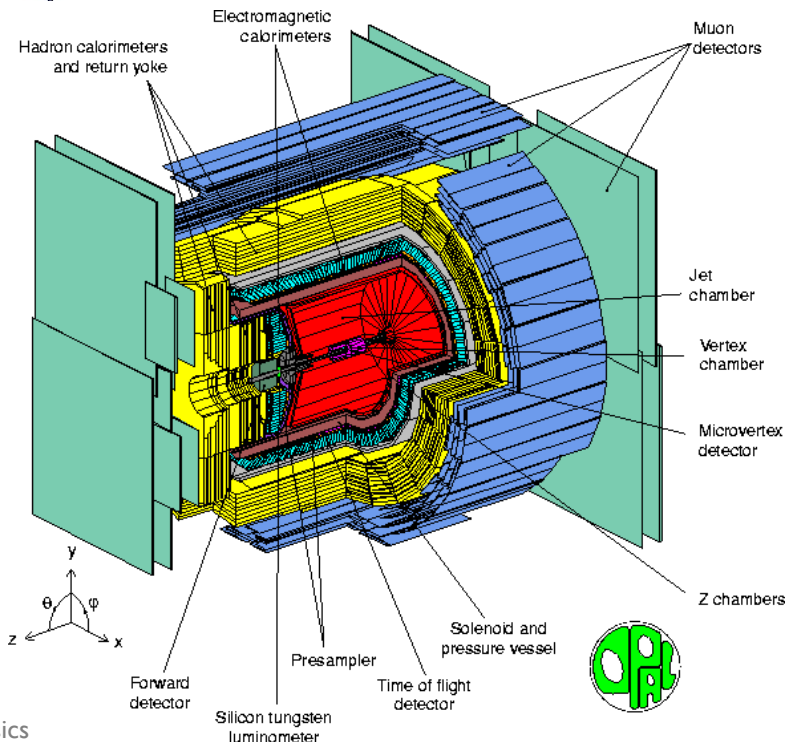

Event display game

A	$Z \rightarrow e^+ e^-$
B	$Z \rightarrow \mu^+ \mu^-$
C	$Z \rightarrow \tau^+ \tau^-$
D	$Z \rightarrow q \bar{q}$
E	$Z \rightarrow q \bar{q} g$
F	$ZZ \rightarrow e^+ e^- \mu^+ \mu^-$
G	$ZZ \rightarrow e^+ e^- q \bar{q}$
H	$ZZ \rightarrow \mu^+ \mu^- q \bar{q}$

I	$WW \rightarrow e \nu \mu \nu$
L	$WW \rightarrow \mu \nu \mu \nu$
M	$WW \rightarrow \tau \nu \tau \nu$
N	$WW \rightarrow \tau \nu \mu \nu$
O	$WW \rightarrow e \nu q \bar{q}$
P	$WW \rightarrow \mu \nu q \bar{q}$
Q	$WW \rightarrow \tau \nu q \bar{q}$
R	$WW \rightarrow q \bar{q} q \bar{q}$

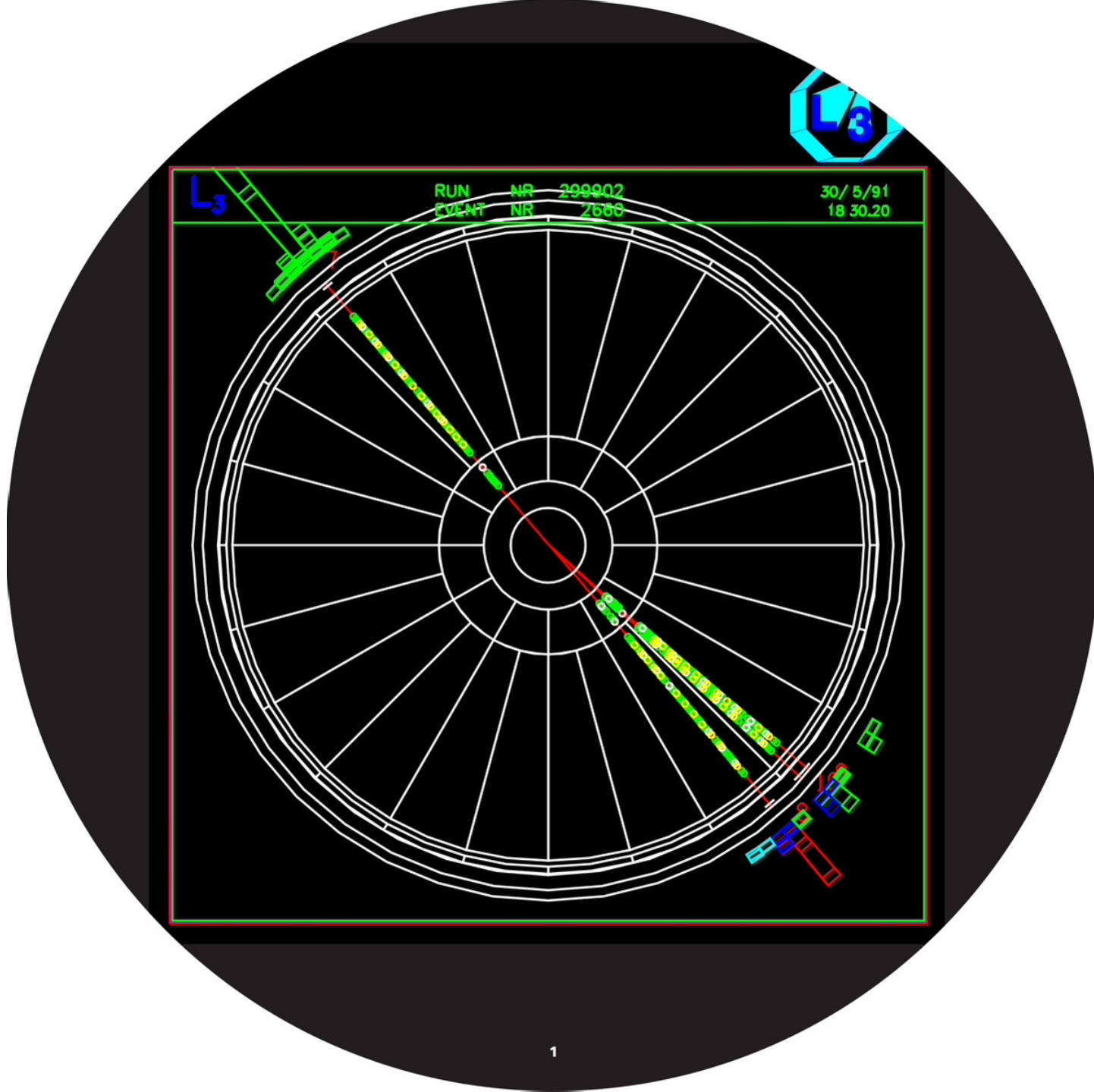

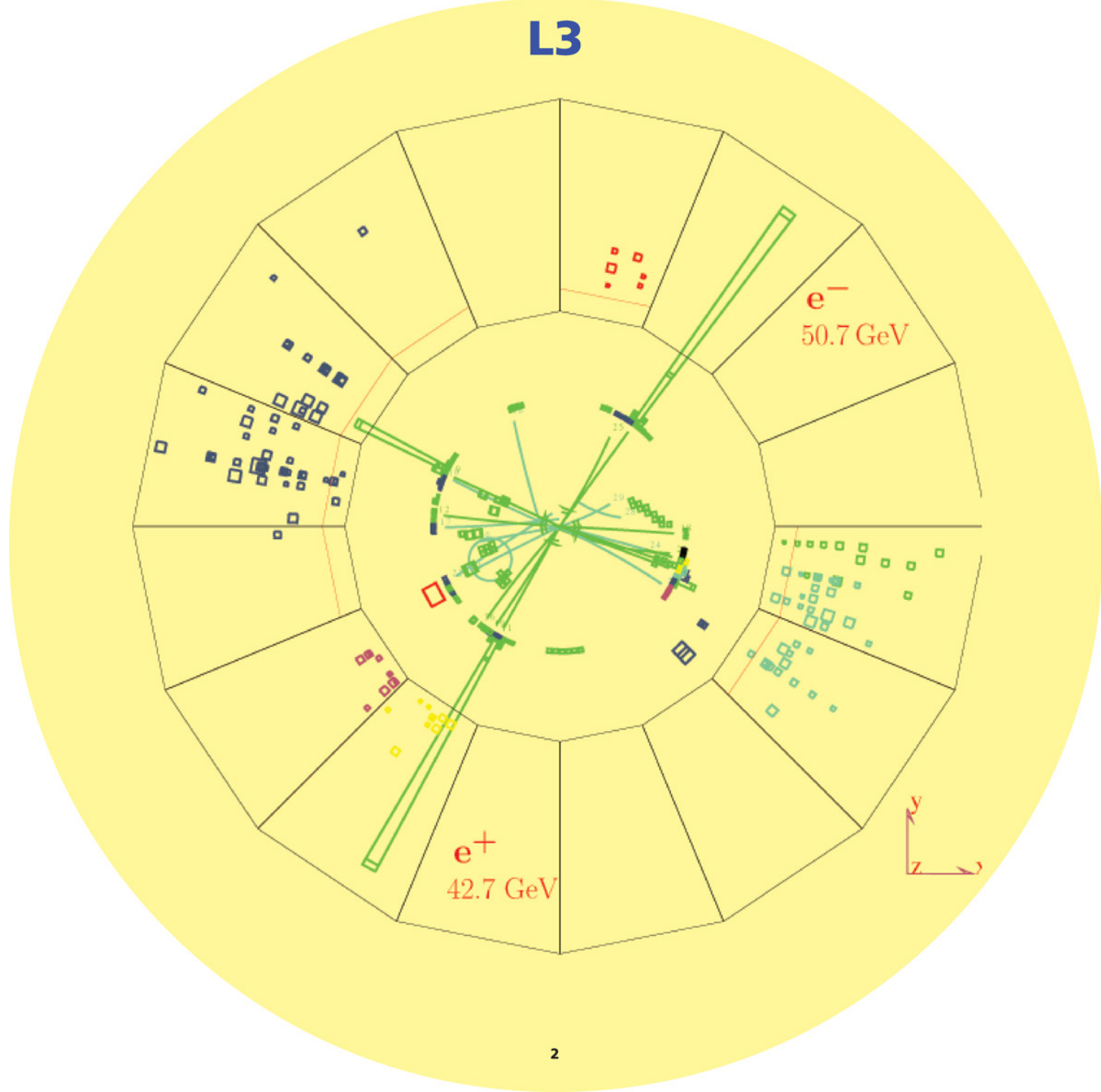

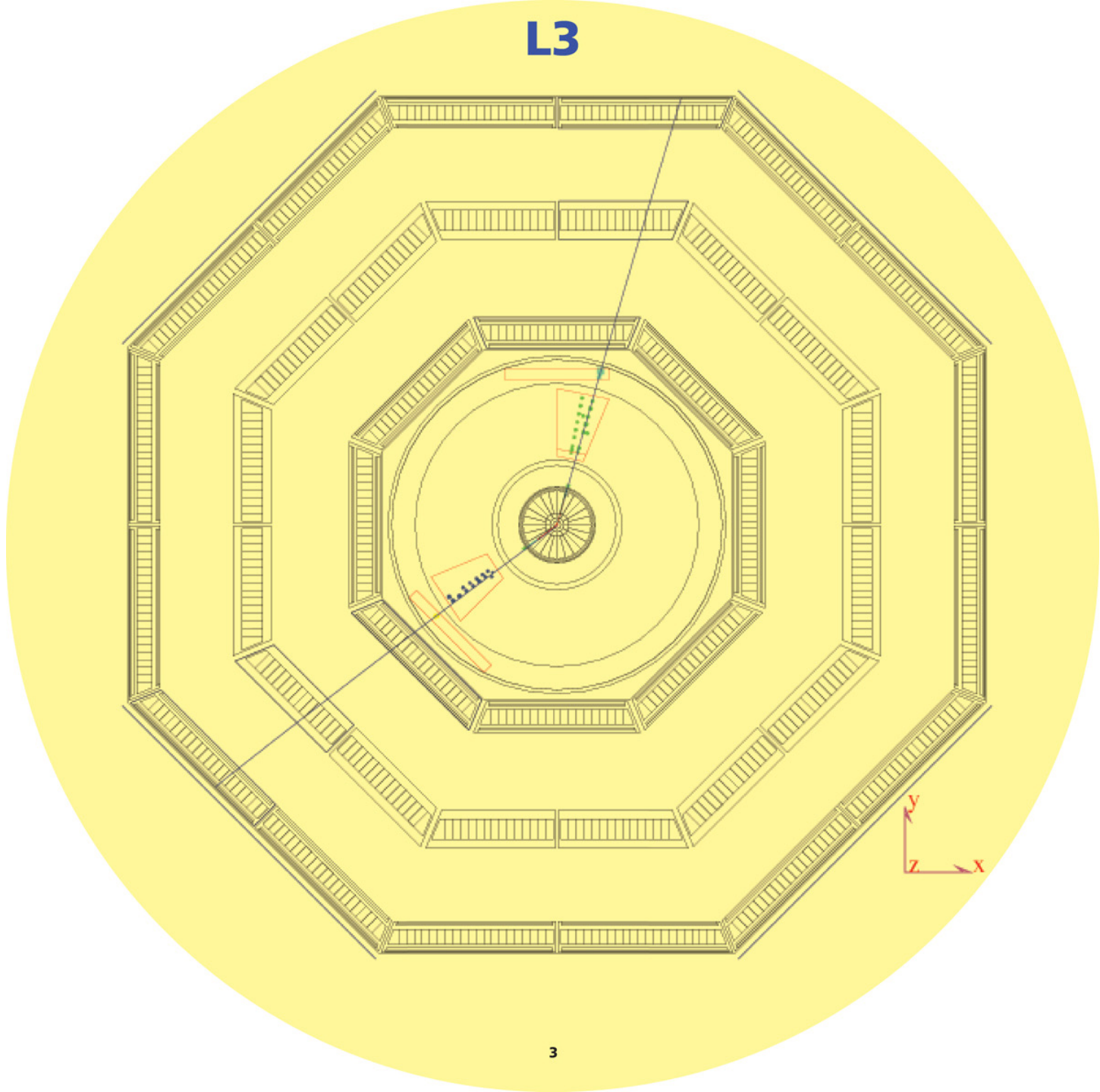

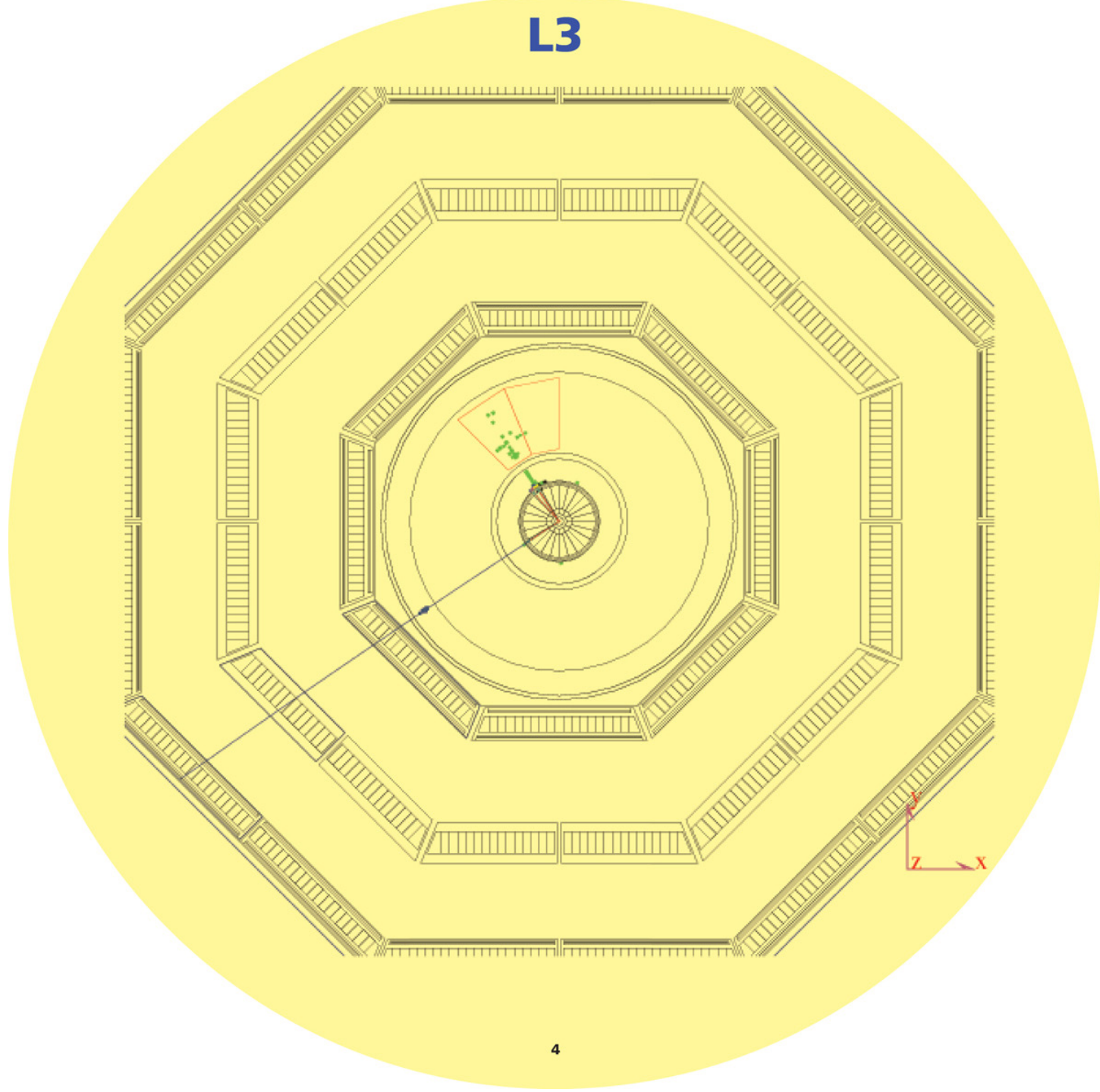

ALEPH

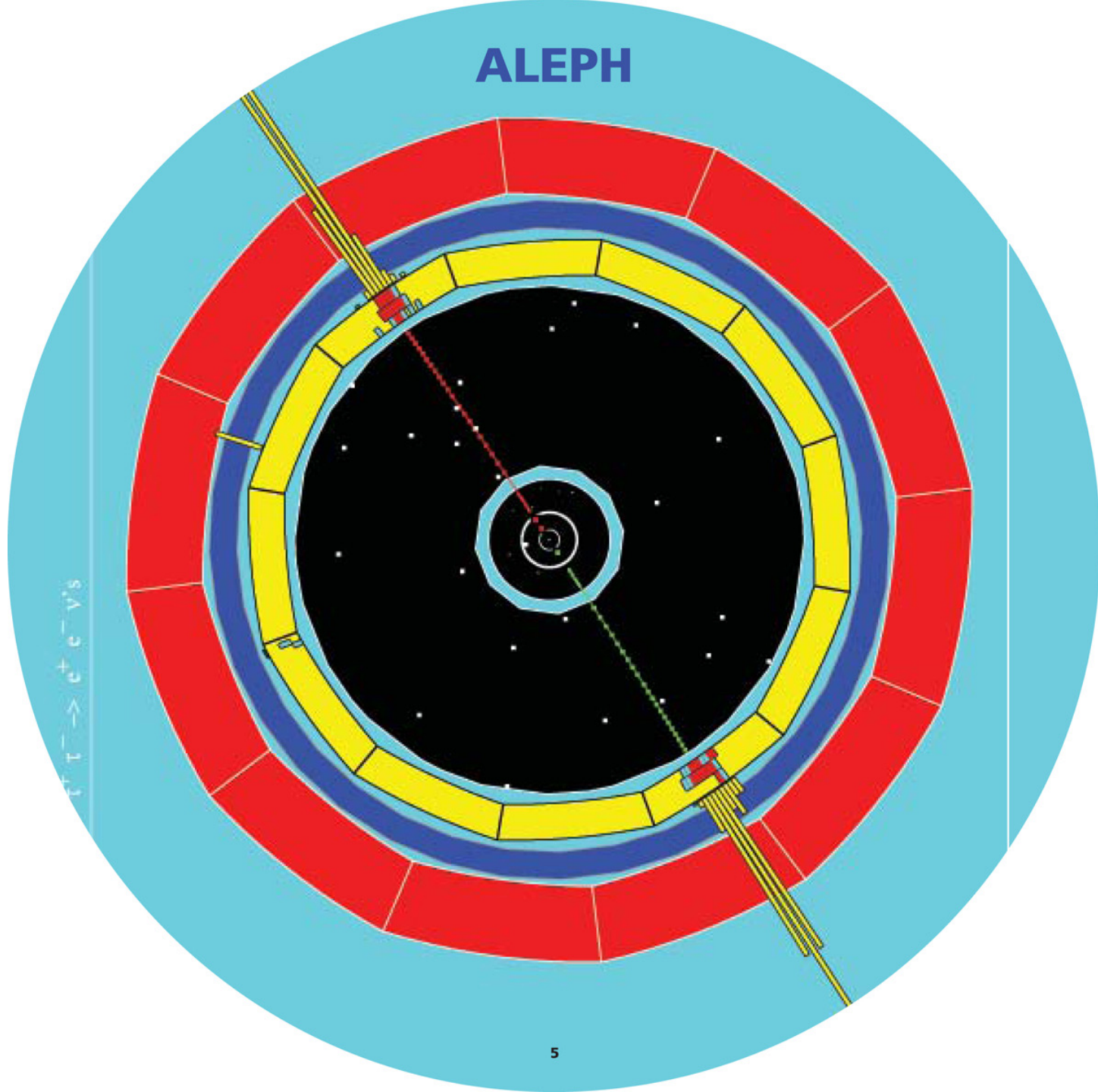

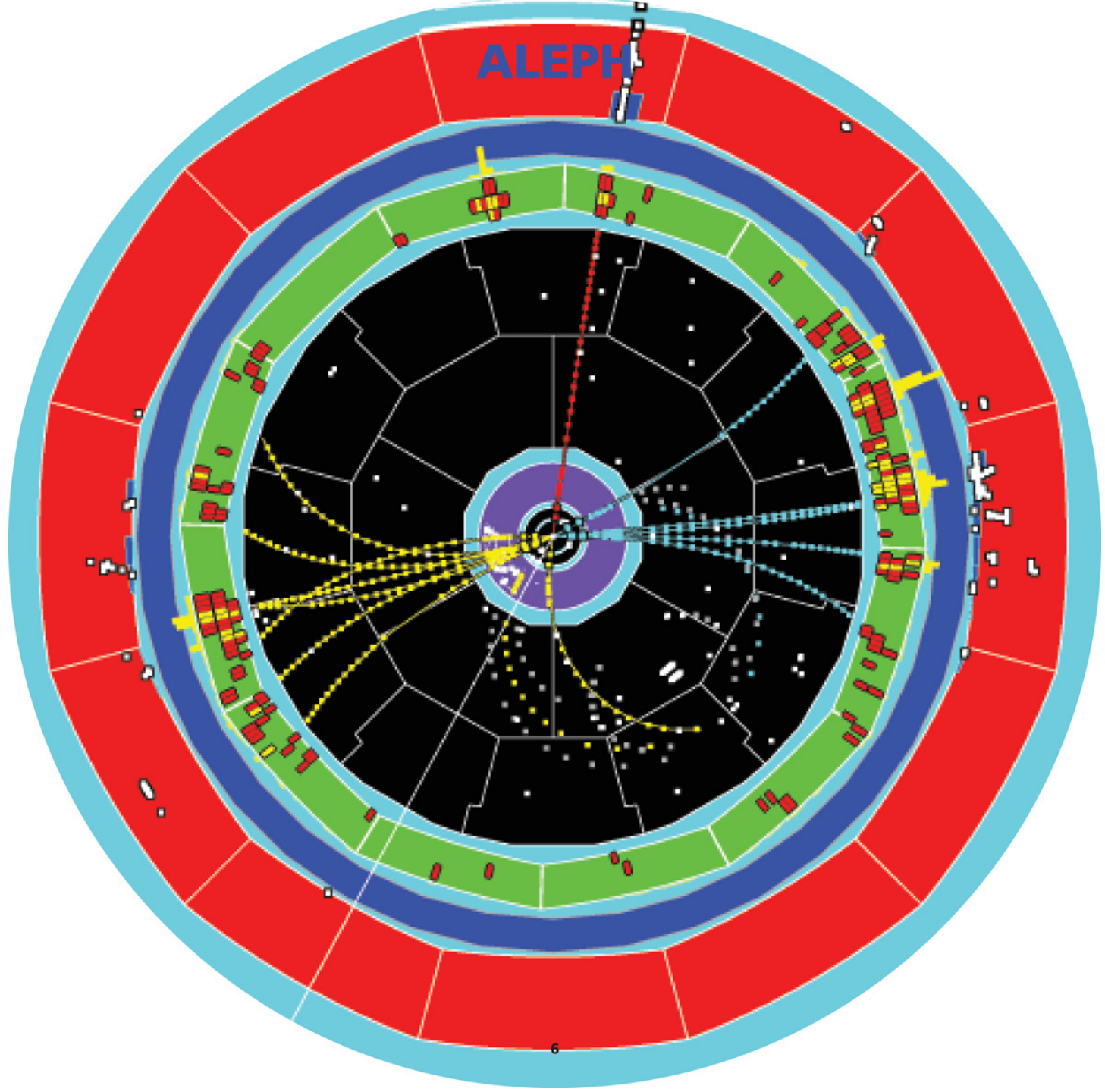

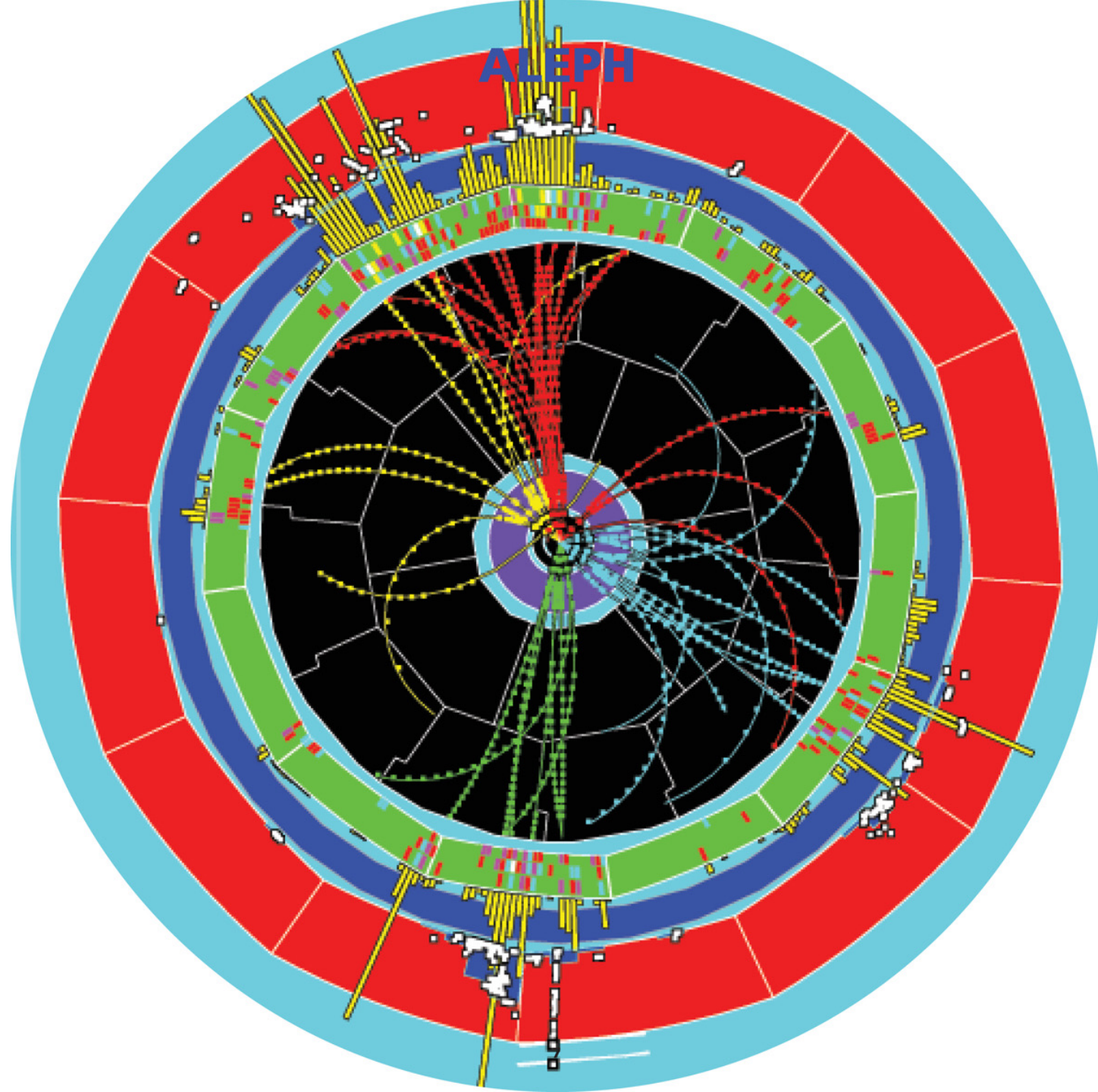

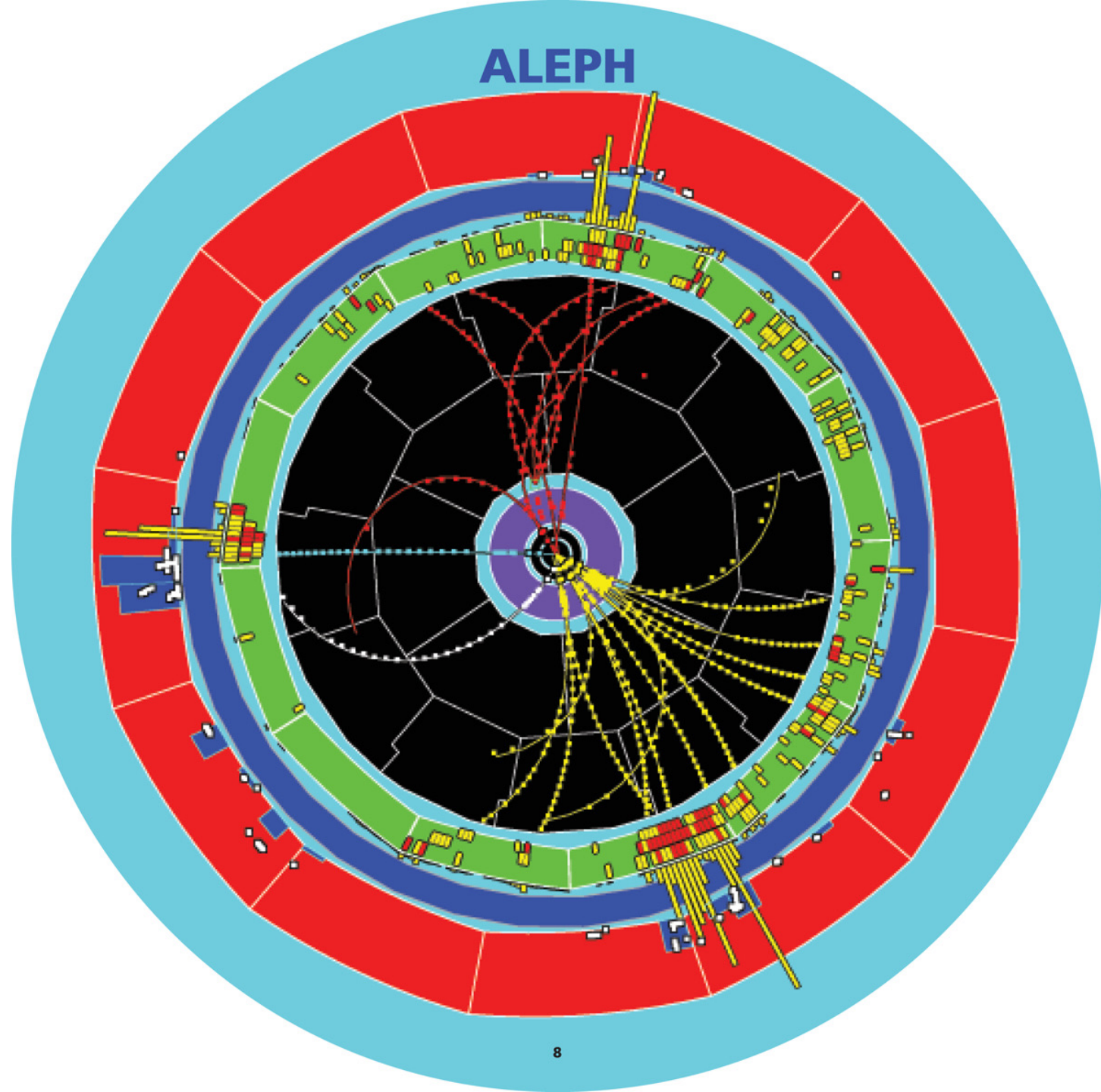

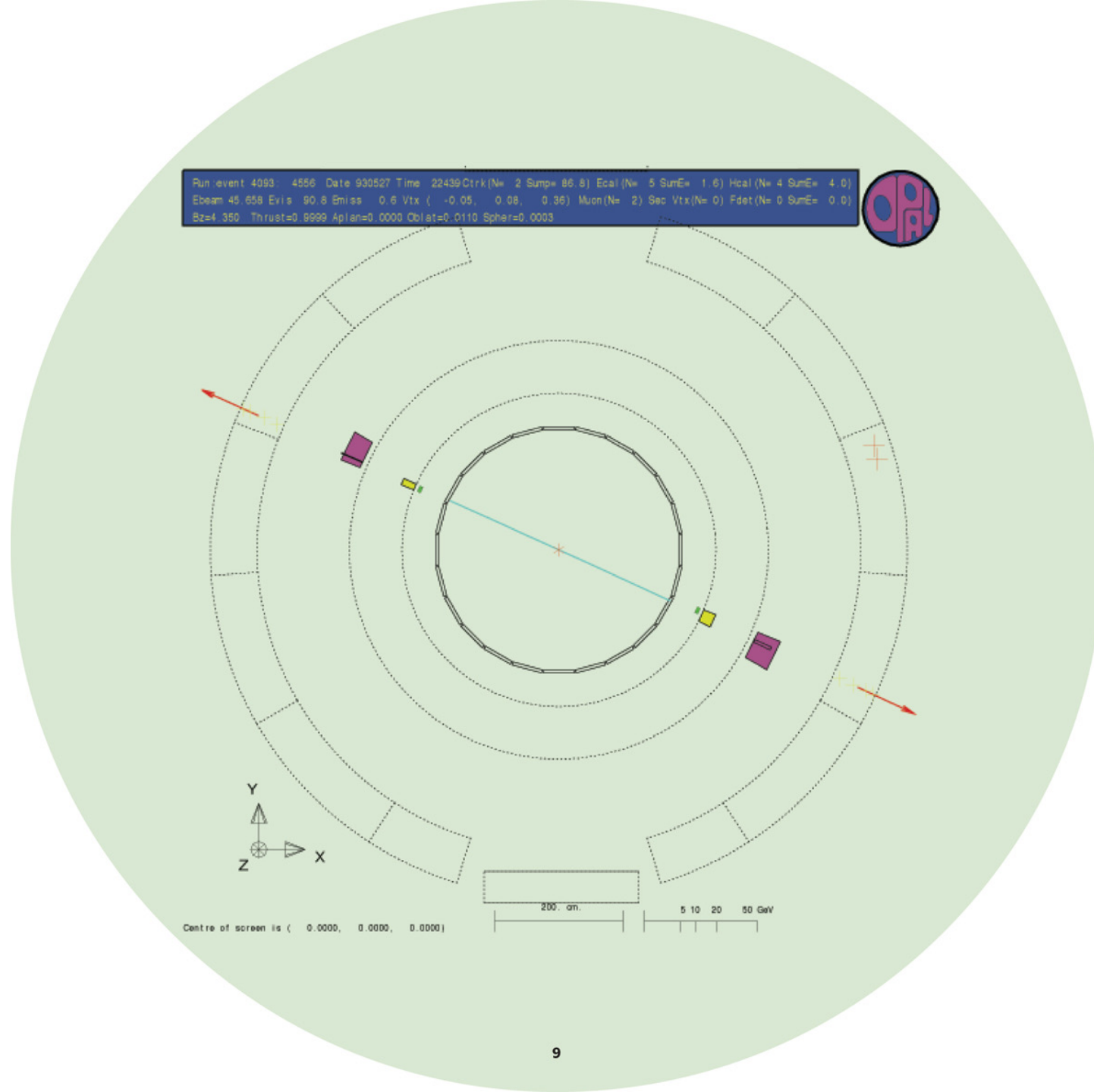

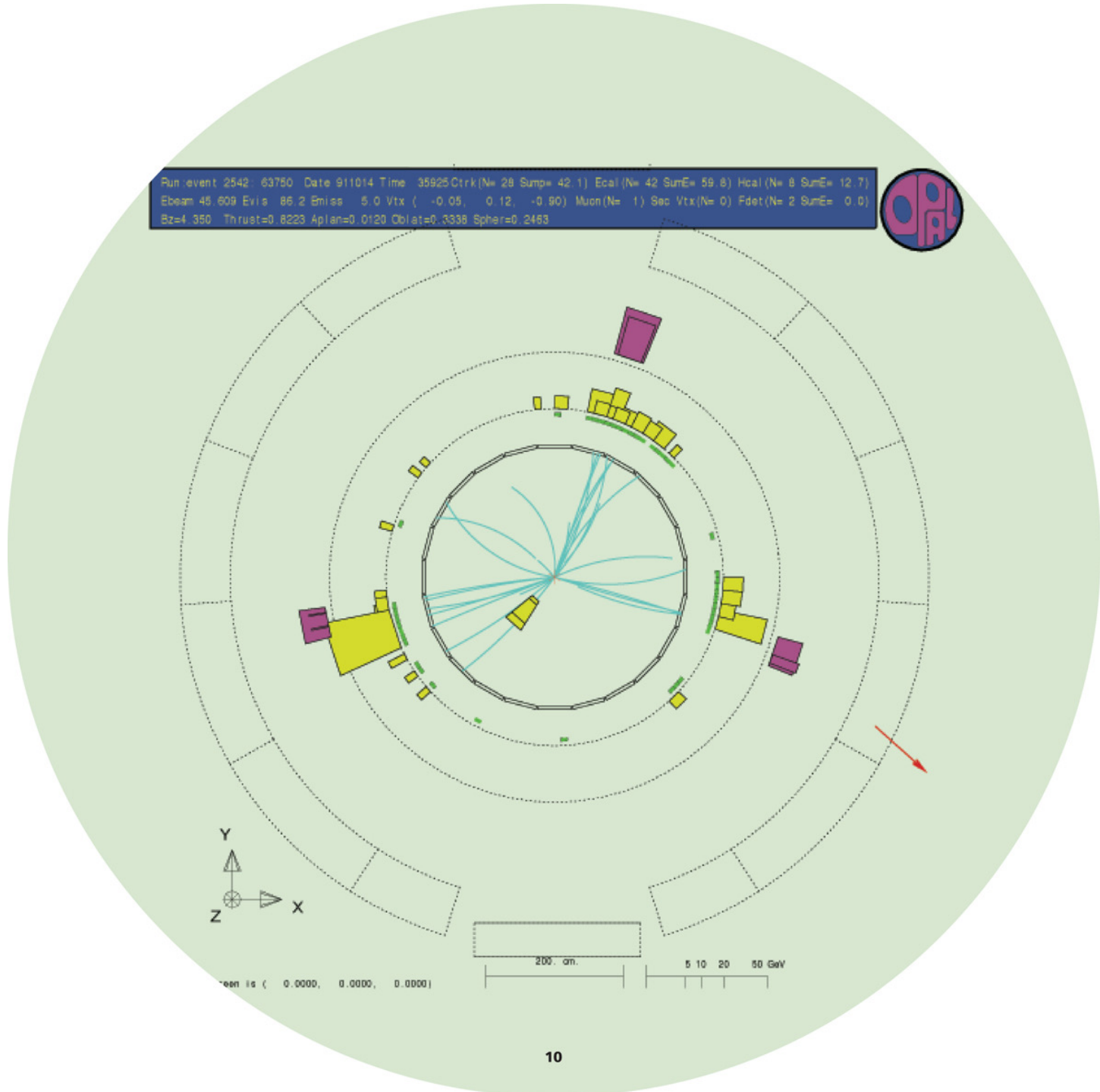

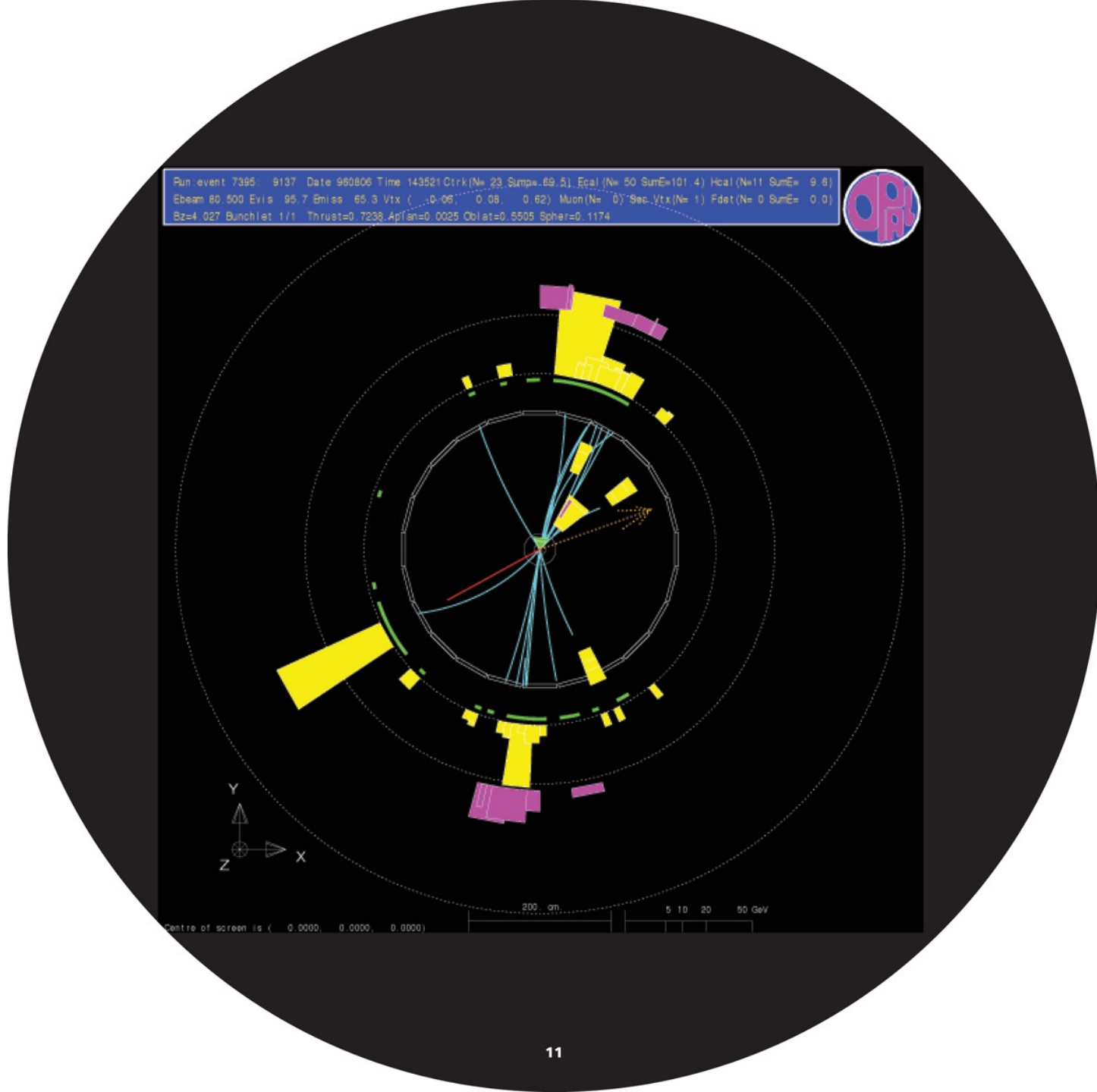

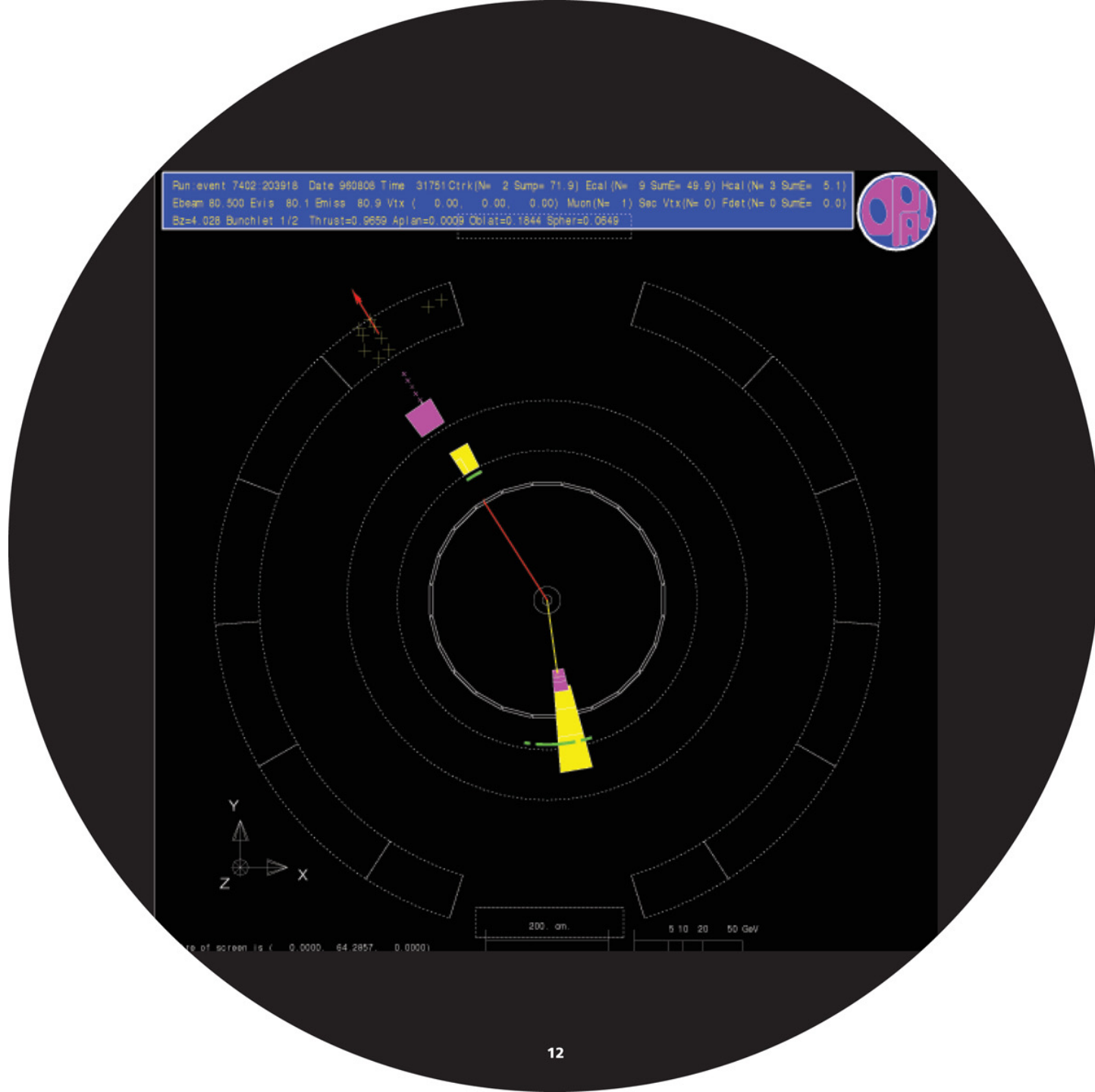

DELPHI

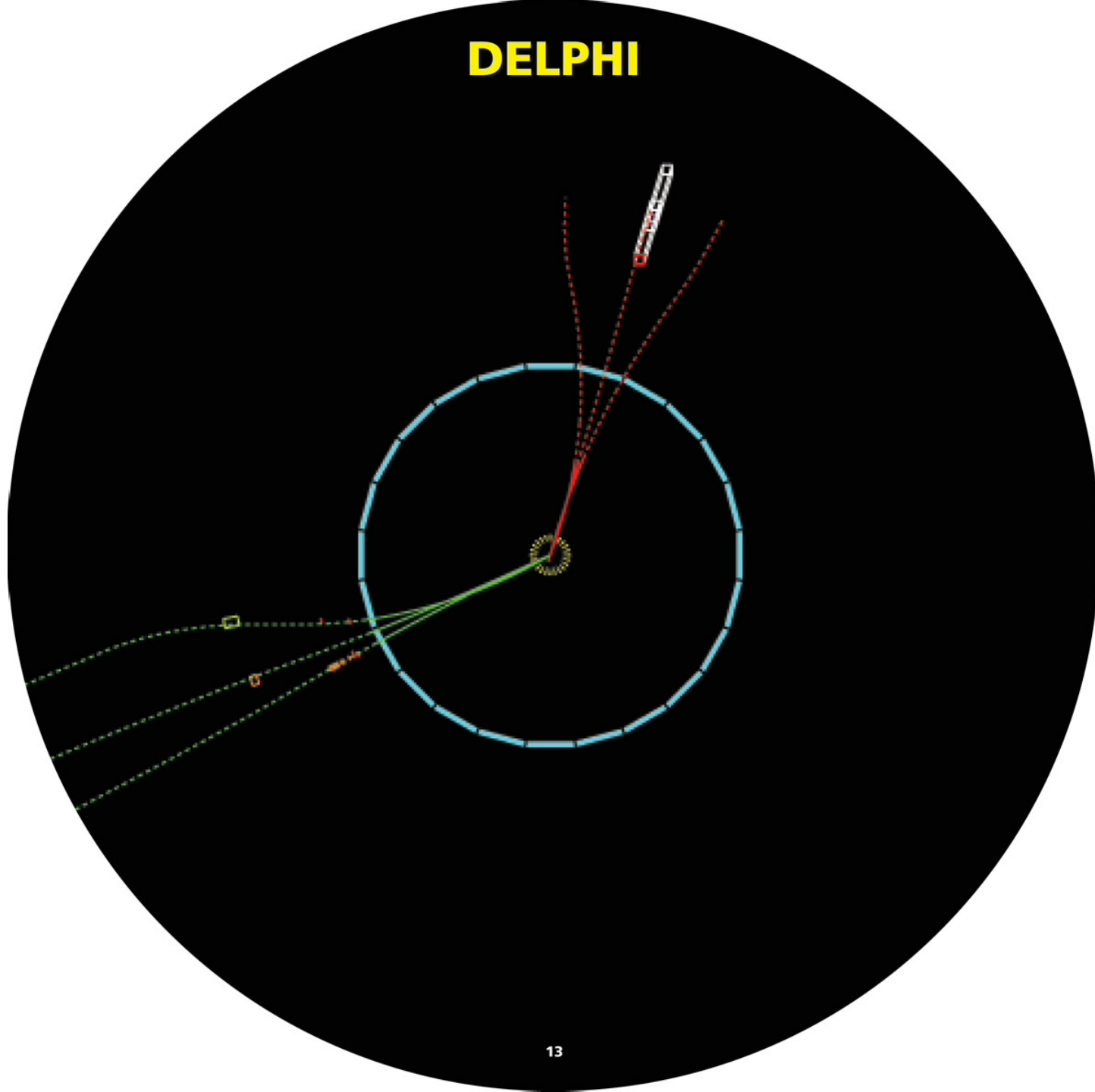

DELPHI

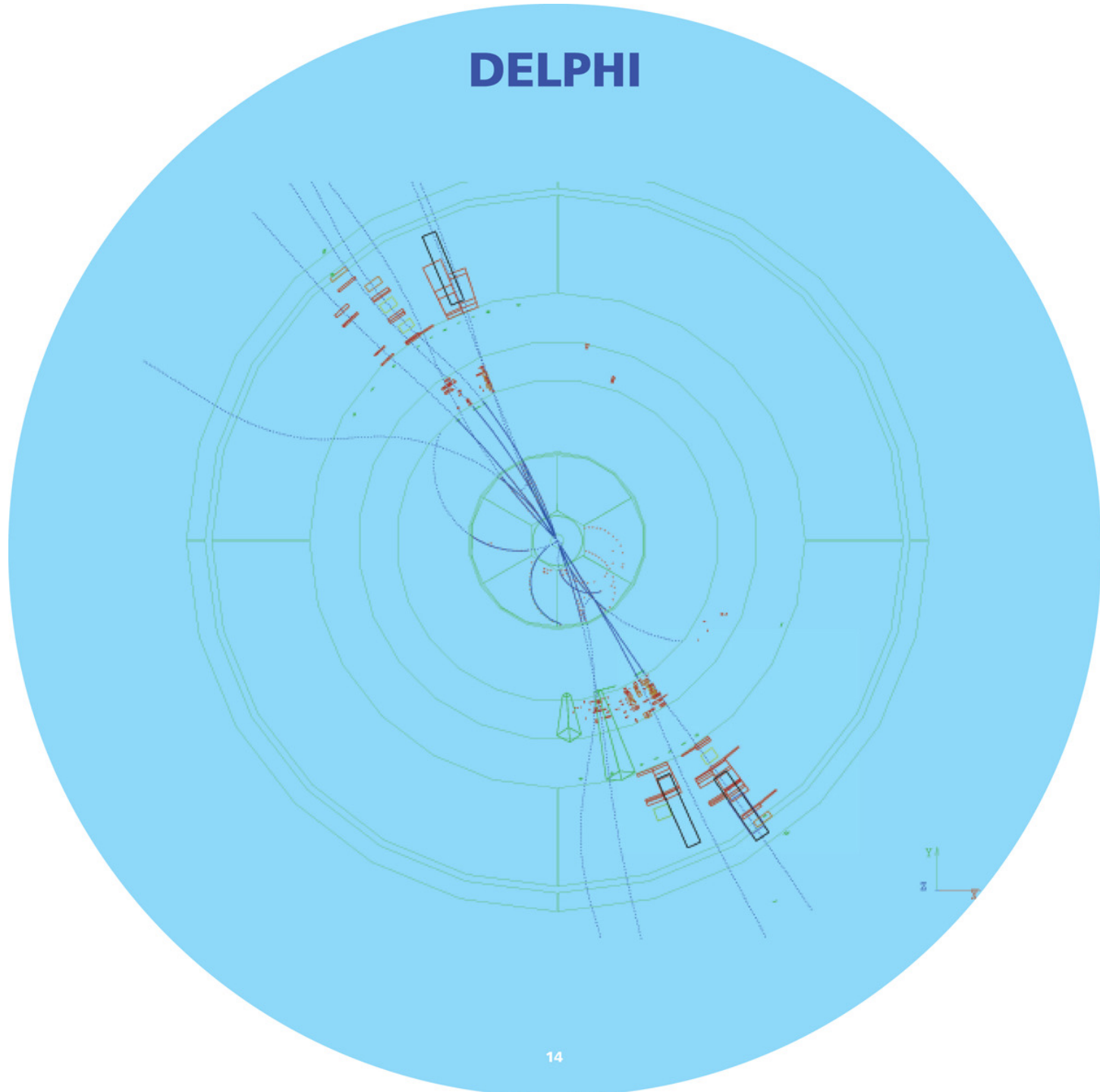

DELPHI

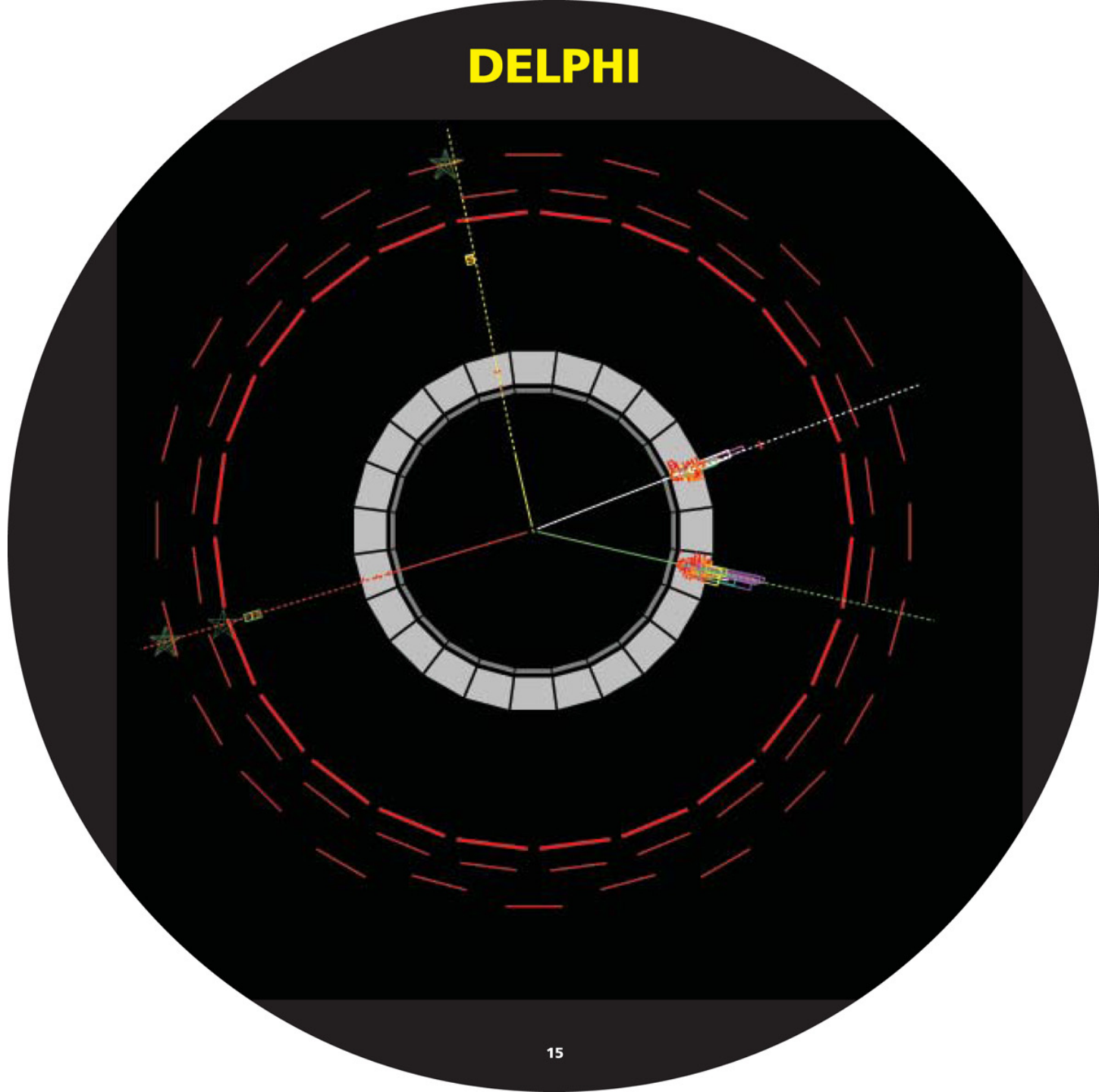

DELPHI

