

CERNBox for simulations on Terminal Servers

Marton Ady - CERNBox user forum, 08.12.2021

Heavy simulations (commercial software)

Vectorfields Opera

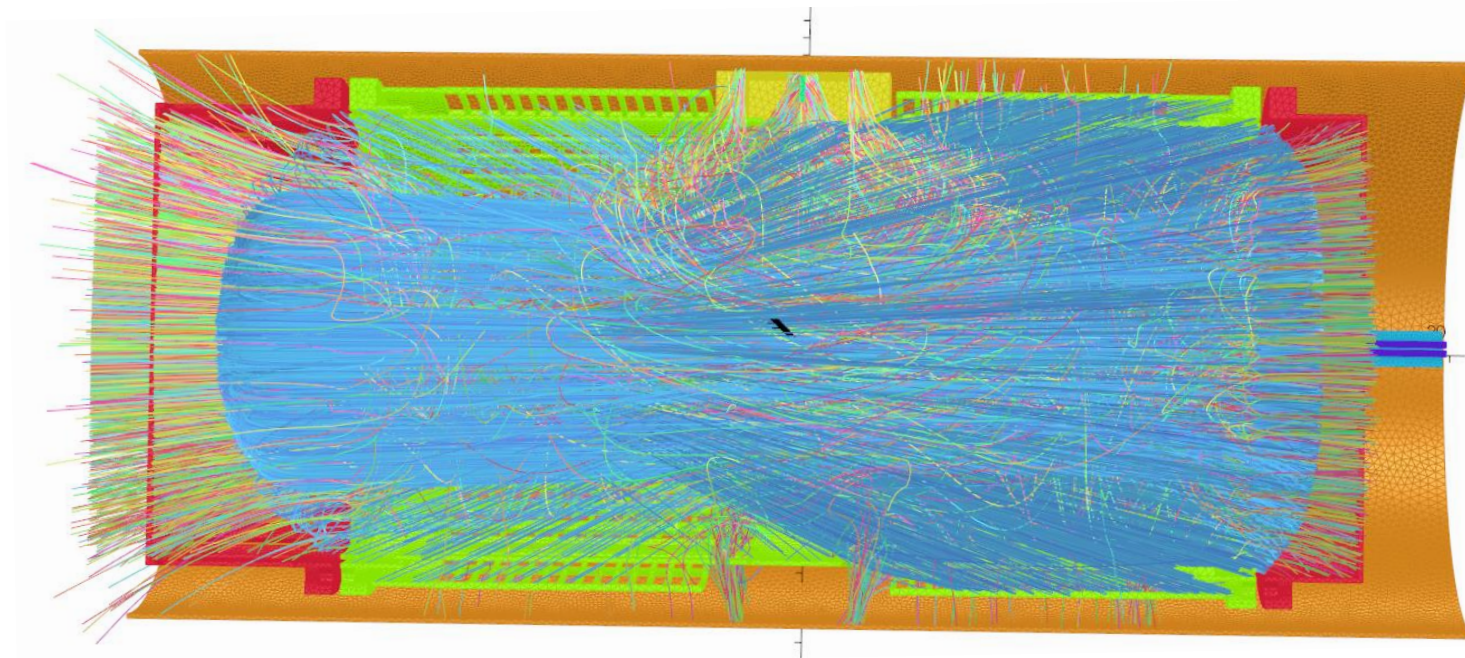

COMSOL Multiphysics

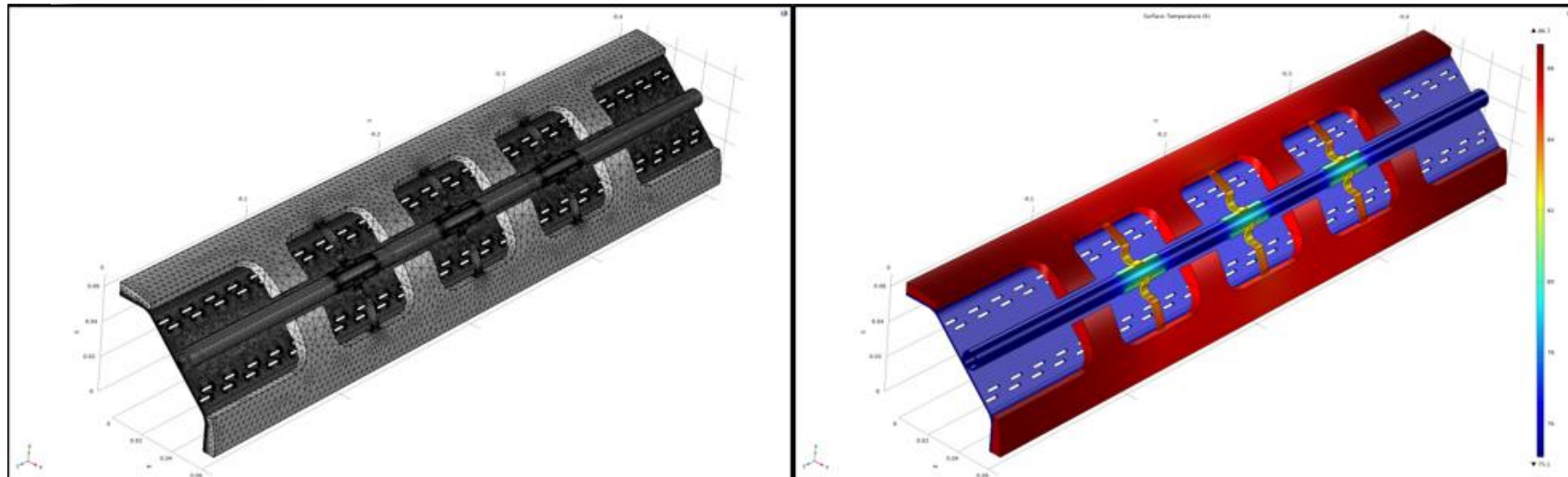

Dedicated Monte Carlo codes

MolFlow+ (ultra high vacuum)

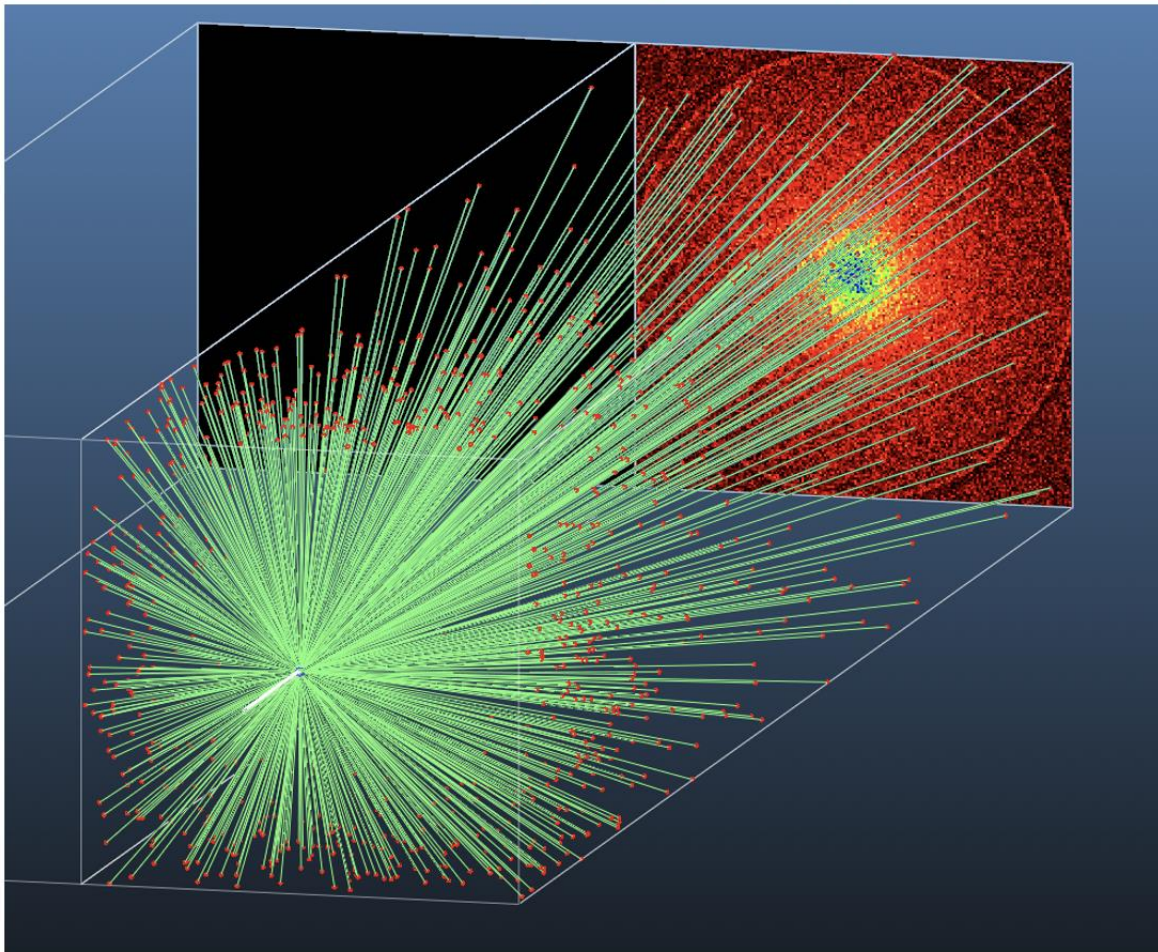

SynRad+ (synchrotron radiation)

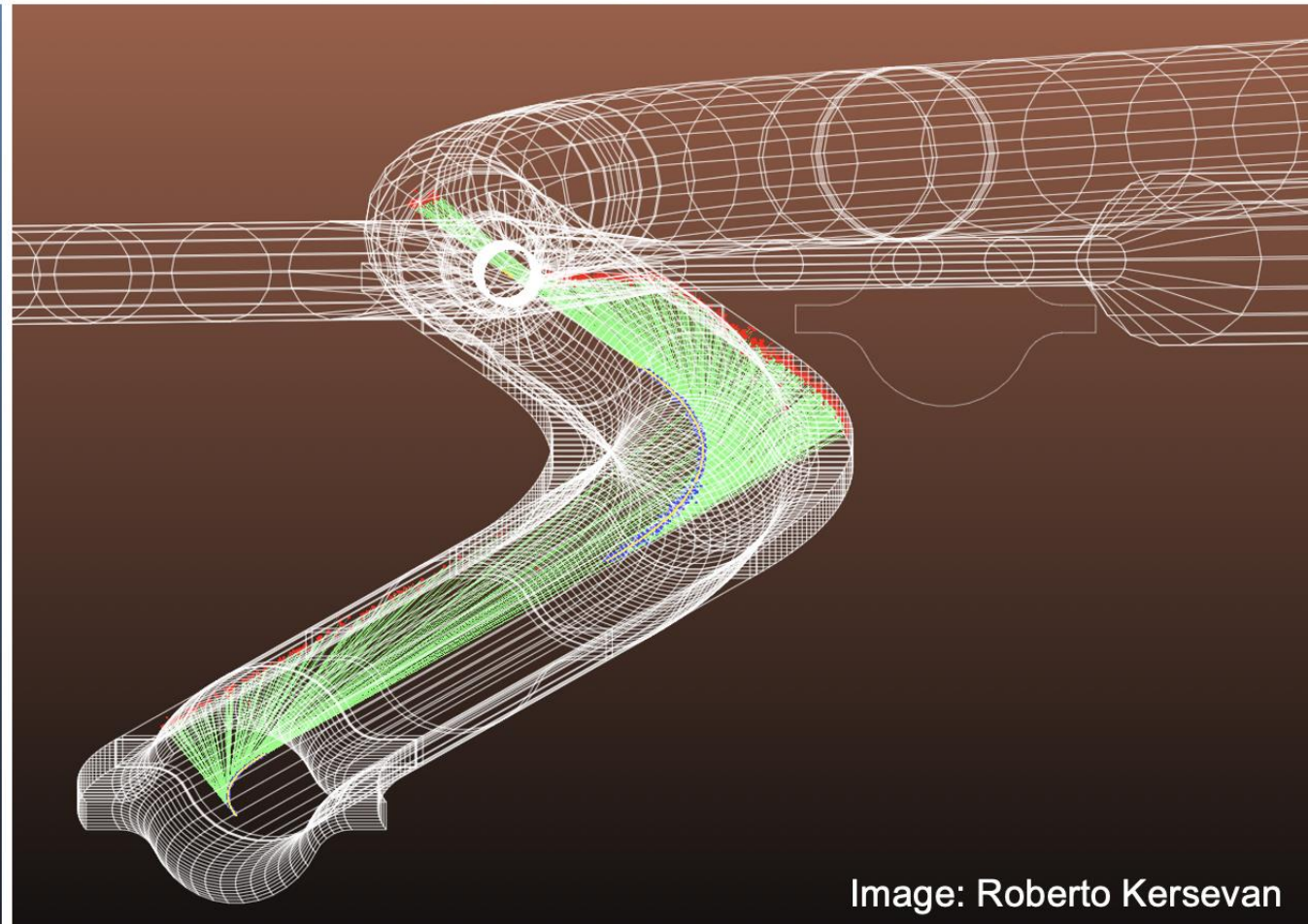
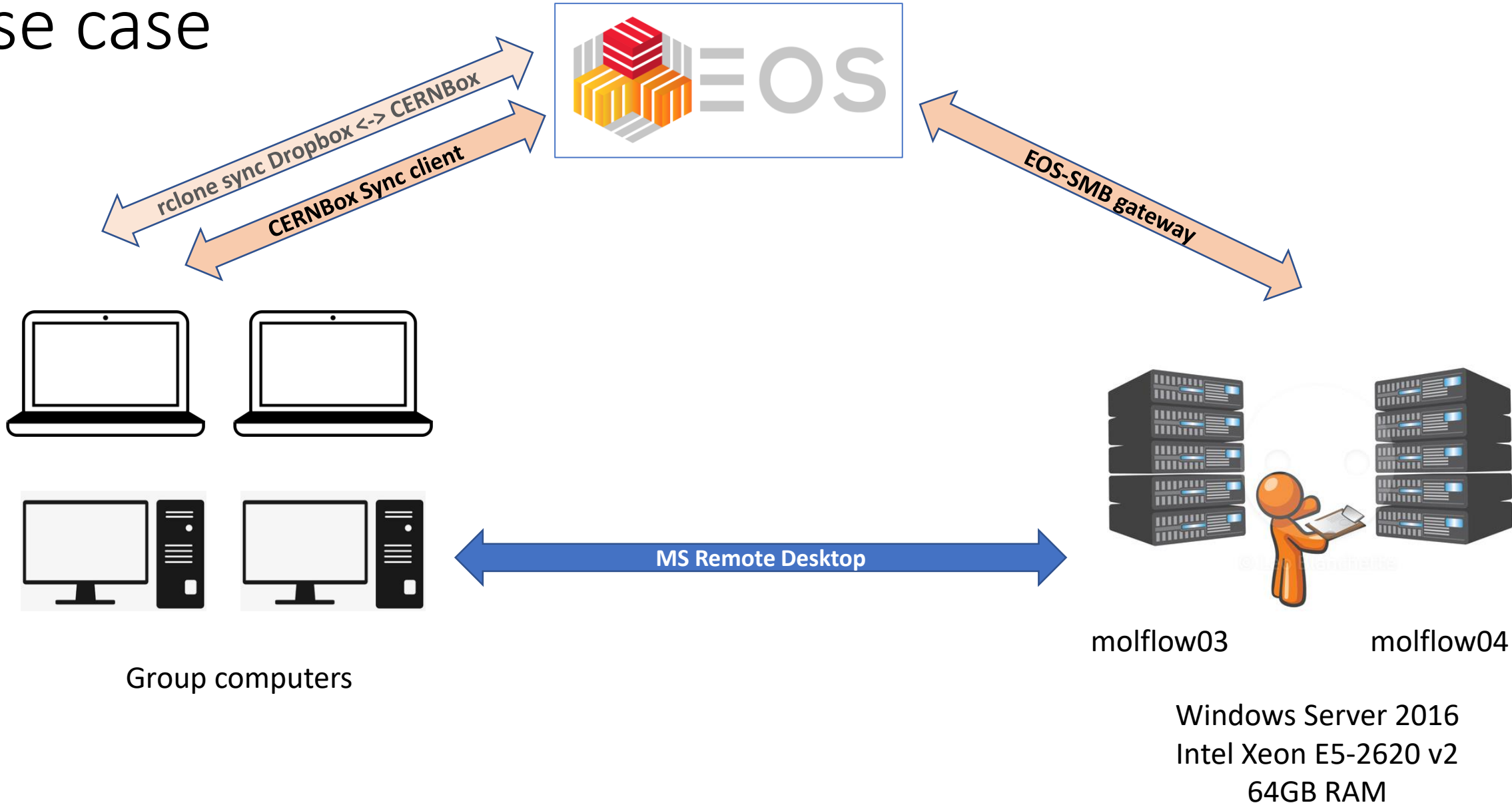

Image: Roberto Kersevan

Use case



Typical workflow

1. Prepare file for simulation locally (RDP is laggy, max. OpenGL2.0)
2. Save file to local home folder, wait to sync
3. Open file on remote terminal (Windows explorer through SMB)
4. Launch simulation remotely, save
5. Open or reload file locally once synced back

Issues

- No file versioning
- No recovery of deleted files

OS/Device	SW being used to access files	Versions are kept?	If versions are kept, can user do a restore?	What is max number of versions kept?	Is the space used by versions taken from user's quota allowance?
Windows	• Web browser	Yes	By Web interface	10 ³)	Yes
	• Sync Client	Yes	By Web interface	10 ³)	Yes
	• WebDAV (via Cyberduck)	Yes ¹⁾	By Web interface	10 ³)	Yes
	• Samba	No	<i>Versions are not kept</i>	<i>Versions are not kept</i>	<i>Versions are not kept</i>

([Source](#) in Cernbox manual)

Summer 2020: disconnects and hangs

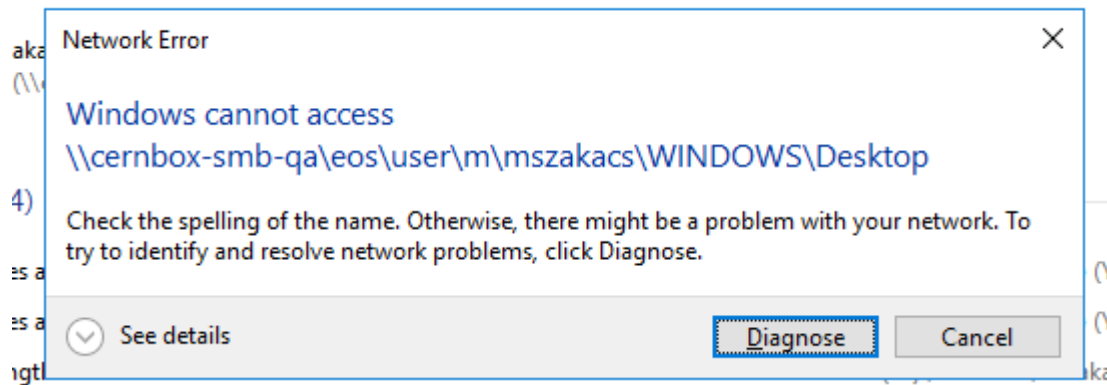
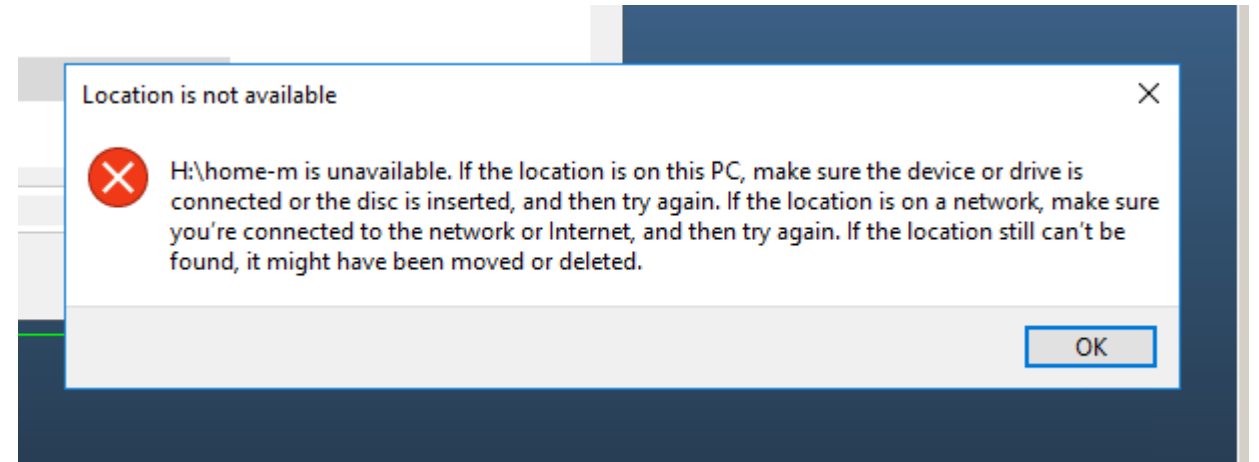
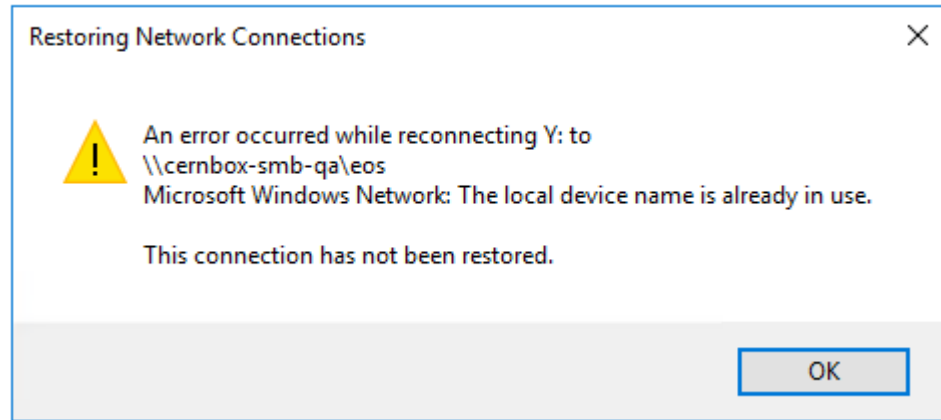

- Folder listing takes minutes
- Any problem completely hangs the app or Windows

Tried alternative: client sync on servers

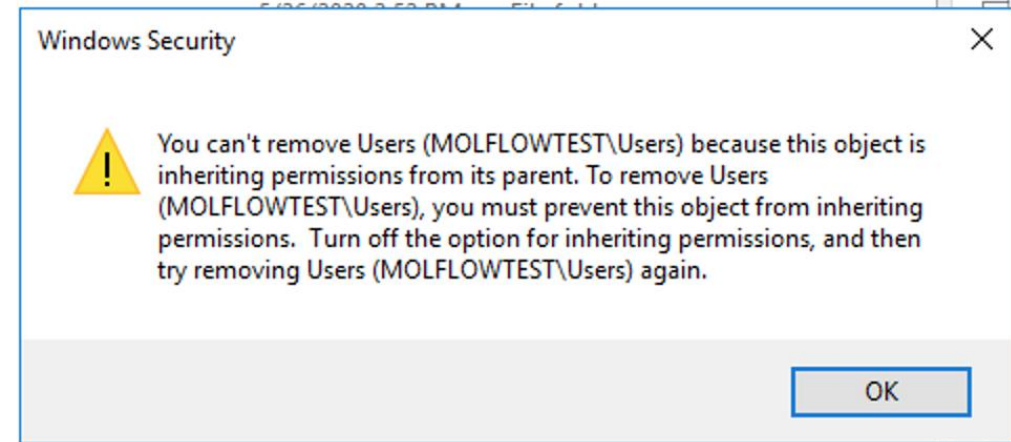
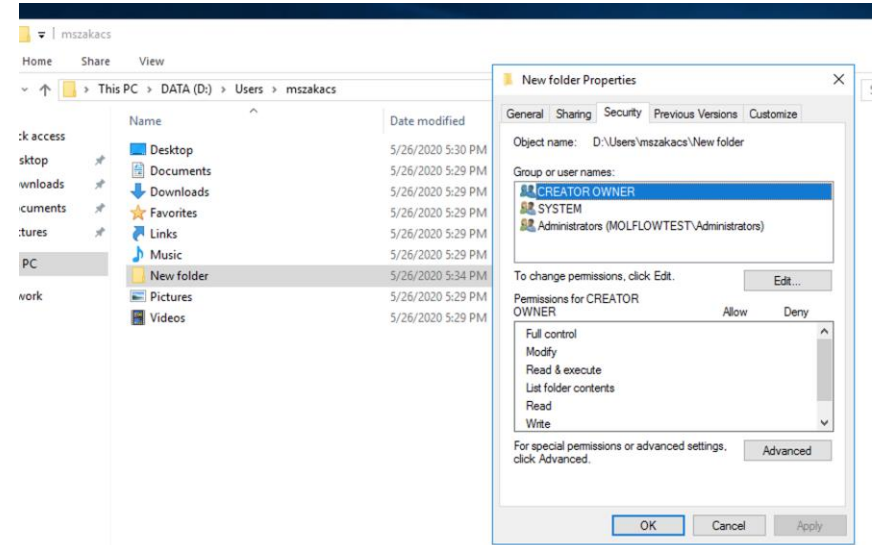
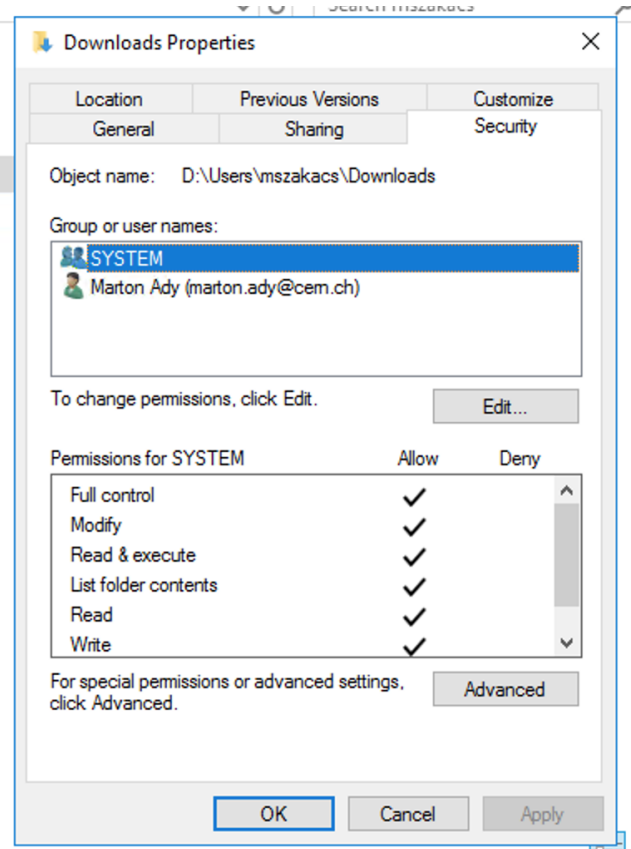

Replace all child object permission entries with inheritable permission entries from this object

Huge thanks to Pablo ZAMORA for relentless effort!

Tried alternative: client sync on servers

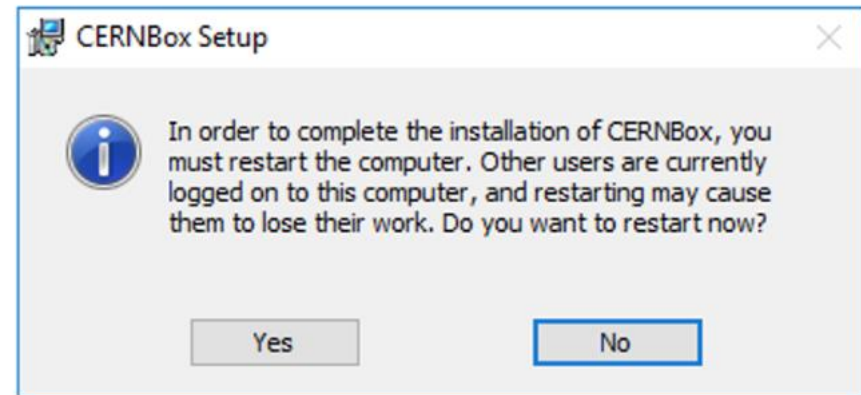
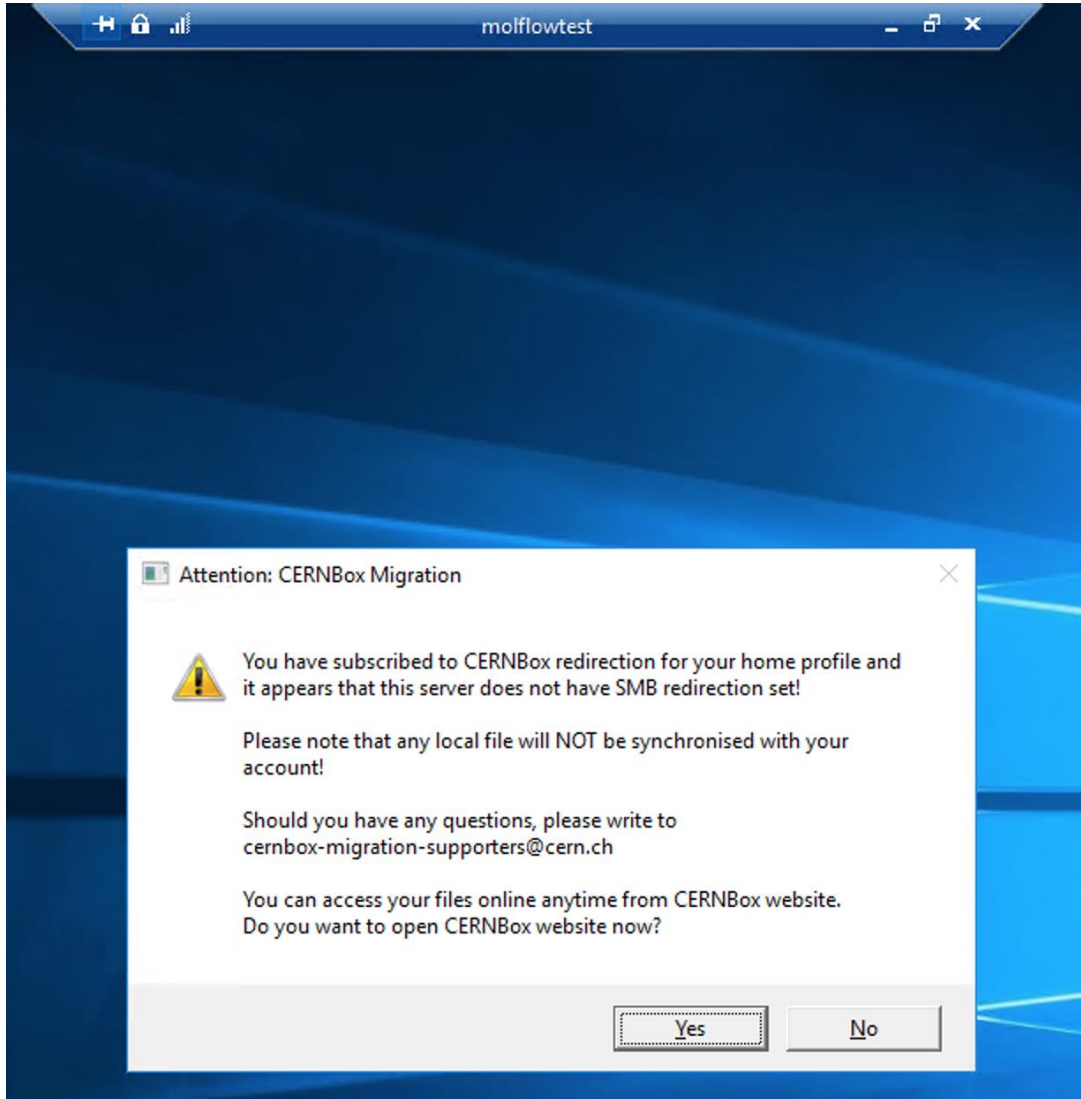

Solved around end of 2020, kind of works now.

Opening 6MB text file in Notepad:

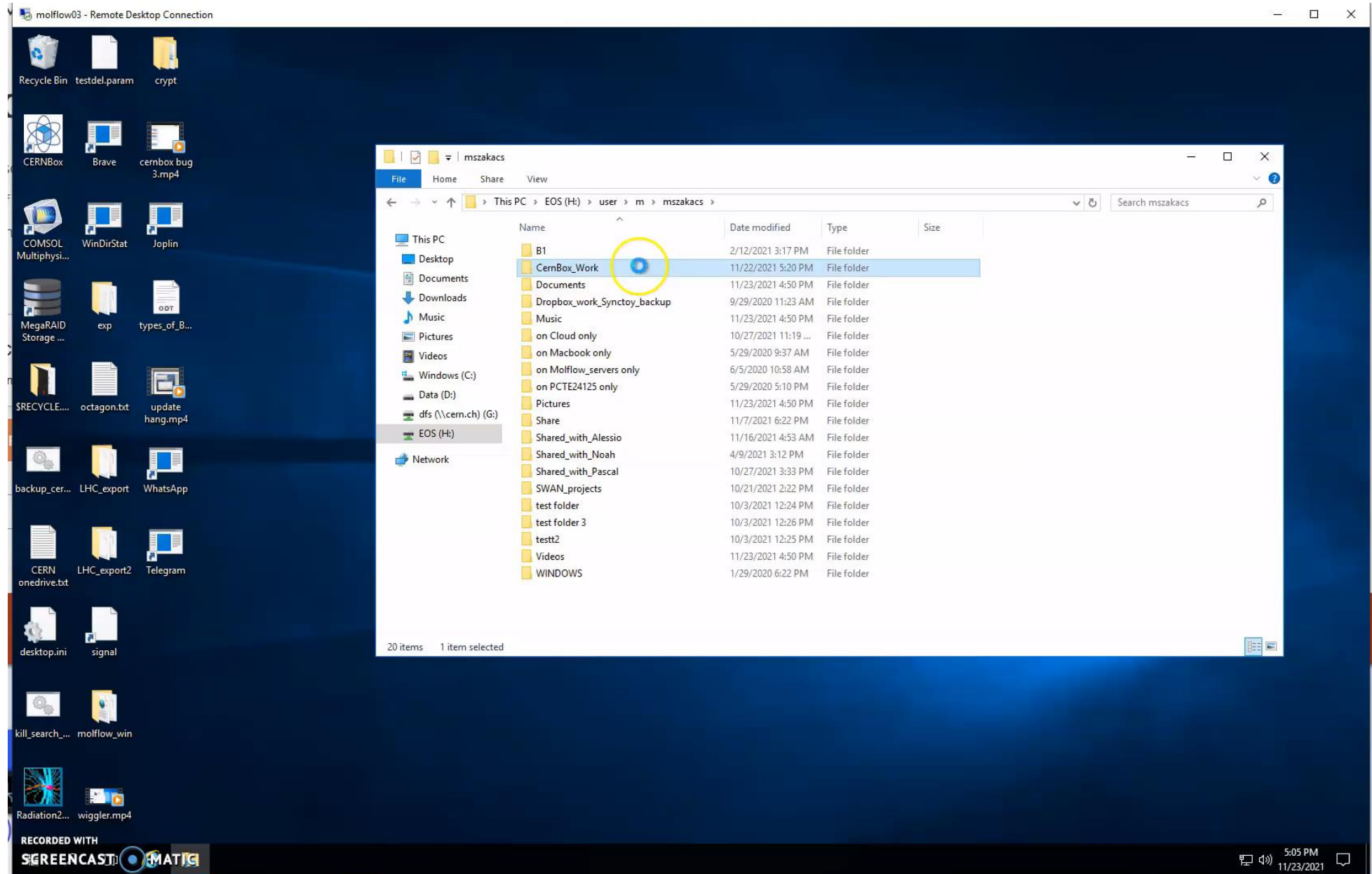

In-house product: extreme effort to keep alive and bug-free

Incidents						
Created	Number	Incident state	Incident Location	Short Description	Closed	
10-11-2021 16:57:28	INC2976157	Closed	30/2-004	CERNbox iOS client folder listing times out	23-11-2021 00:08:20	
04-08-2021 09:38:19	INC2874935	Closed	30/2-004	CERNBox: "shared by link" doesn't load	01-09-2021 00:16:45	
07-04-2021 15:11:30	INC2756420	Closed	30/2-004	Cernbox client: EOS shared folder can't sync (forbidden)	15-04-2021 00:02:40	
26-10-2020 15:28:25	INC2585238	Closed	30/2-004	CERNBOX: versioning unavailable for shared folders	07-11-2020 00:08:49	
14-07-2020 11:23:15	INC2491778	Closed	30/2-004	CERNBox down	22-07-2020 00:04:54	
29-05-2020 09:56:36	INC2430367	Closed	30/2-004	CERNBox multiple issues	30-07-2020 00:02:47	
21-02-2020 09:37:51	INC2337147	Closed	30/2-004	CERNBox: degraded service	03-03-2020 00:04:12	
19-02-2020 16:08:07	INC2311902	Closed	30/2-004	CERNBox SMB mount intermittent outage	24-04-2020 00:03:57	
11-04-2019 19:39:27	INC1963854	Closed	112/1-021	CERNBox down	24-04-2019 00:01:51	
20-02-2019 15:19:27	INC1922295	Closed	112/1-021	CERNBox: Explorer context menu sharing not working	29-11-2019 00:00:57	
18-09-2018 12:00:09	INC1795343	Closed	112/1-021	CERNBox: iOS client doesn't show files shared by link	04-10-2018 00:04:30	
08-05-2018 15:44:58	INC1671197	Closed	112/1-021	CERNBox bug: sharing by app expires the same day	23-05-2018 00:00:11	
06-06-2016 10:31:57	● INC1049335	Closed	112/1-021	CERNbox sync error: "Server replied: insufficient storage"	13-06-2016 13:48:57	
02-10-2015 11:02:40	INC0868348	Closed	112/1-021	CERNbox iOS client: can't install	09-10-2015 11:50:57	
01-07-2015 13:28:09	INC0816345	Closed	30/1-011	CERNBox: Error 400 (bad request)	03-08-2015 15:50:47	
28-05-2015 16:08:05	INC0794747	Closed	30/1-011	CERNbox - search field not working	08-06-2015 09:49:14	
28-05-2015 16:01:02	INC0794738	Closed	30/1-011	CERNbox - delete files folder wrong date	08-09-2015 17:49:04	
08-05-2015 15:39:41	INC0784301	Closed	30/1-011	CERNBox: "Error fetching URL"	23-06-2015 15:50:48	
13-02-2015 15:31:33	INC0734126	Closed	30/1-011	CERNbox bug report: browser doesn't list all directories	11-09-2015 15:48:28	
03-02-2015 15:27:21	INC0726017	Closed	30/1-011	CERNbox: can't download iOS client	12-02-2015 14:48:26	

But CERNBox team was always very helpful!

(Custom client debugging through proxy, etc)

Conclusion

- CERNBox trivial tool to sync files to remote servers
- Deployed for nearly everyone, workarounds for the rest
- Performance and reliability issues, but very active support
- Suitable for our case (large files)