

**On behalf of Katy Foraz,
Head of the EN Department,**

**Welcome
to all of you!**



The Engineering Department in a Nutshell

Katy Foraz



ENGINEERING
DEPARTMENT

When will we be doing
what we are expected to do?

A long-term perspective

Long Term Schedule for CERN Accelerator complex

Mar. 2022

Agreed Working Baseline

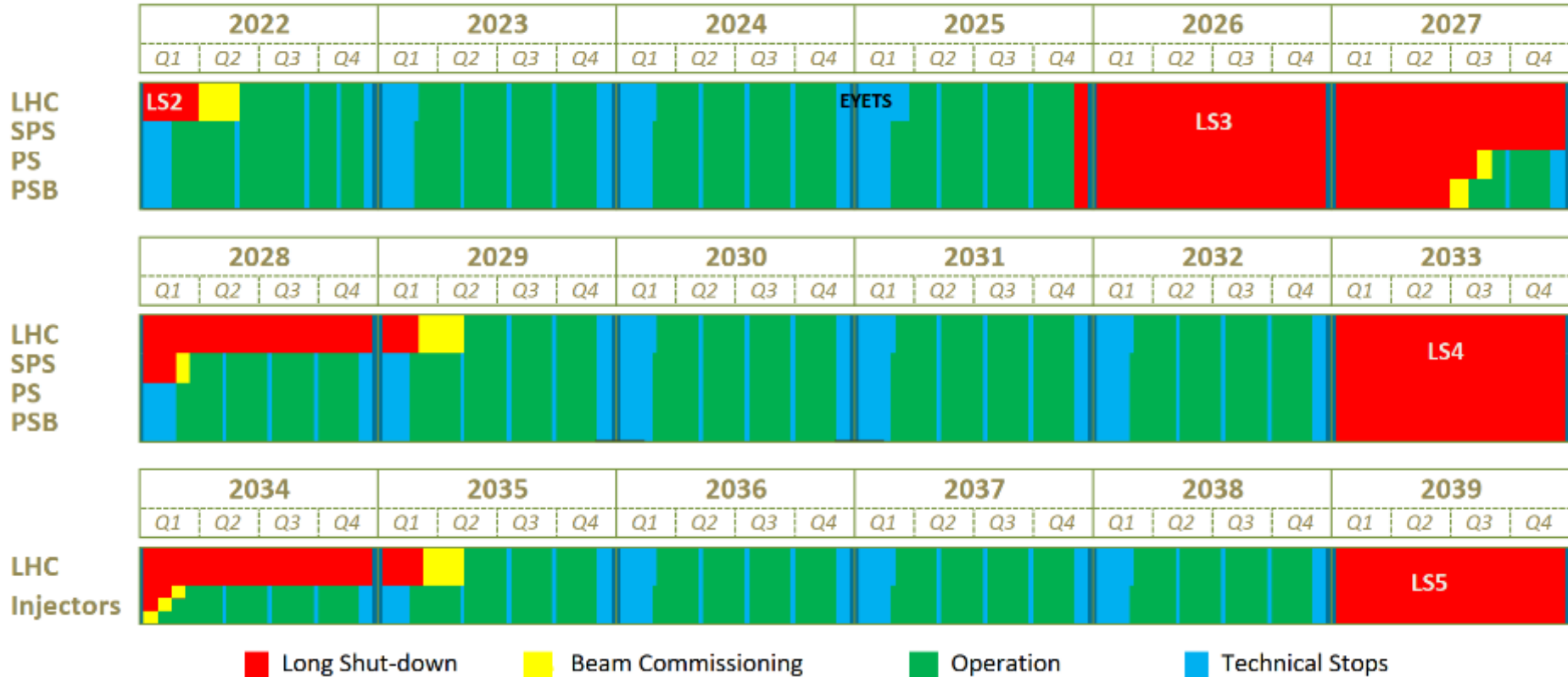

Who are we?

CERN Structure

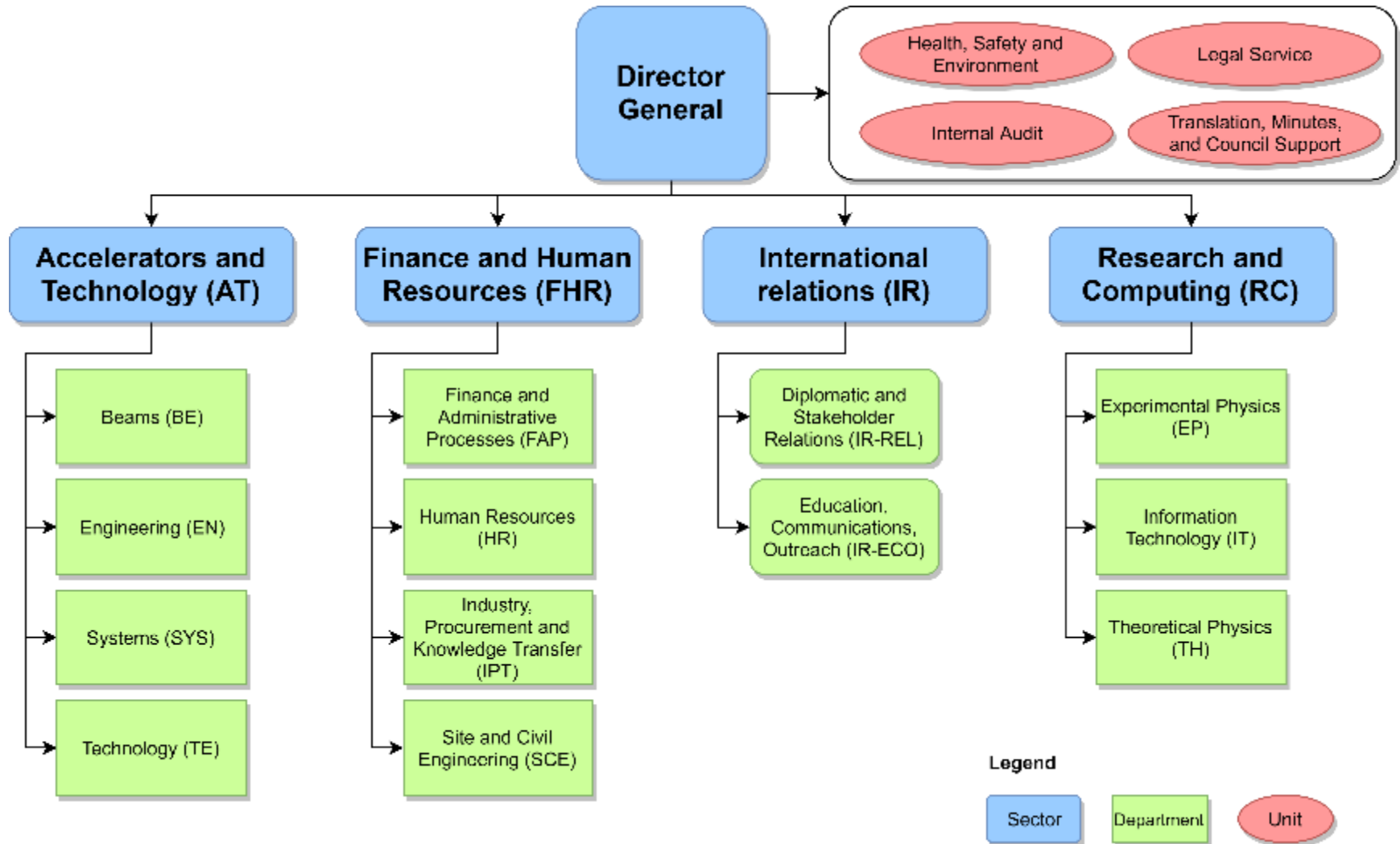

CERN Structure

Directorate

Director-General	Fabiola Gianotti
Director for Finance and Human Resources	Raphaël Bello
Director for Accelerators and Technology	Mike Lamont
Director for Research and Computing	Joachim Mnich
Director for International Relations	Charlotte Warakaulle



CERN Structure

Heads of departments

Accelerator Systems	Brennan Goddard
Beams	Rhodri Jones
Engineering	Katy Foraz
Experimental Physics	Manfred Krammer
Finance and Administrative Processes	Florian Sonnemann
Human Resources	James Purvis
Industry, Procurement and Knowledge Transfer	Christopher Hartley
Information Technology	Enrica Porcari
Site and Civil Engineering	Mar Capeans Garrido
Technology	José Miguel Jiménez
Theoretical Physics	Gian Francesco Giudice

Department Head: Katy Foraz

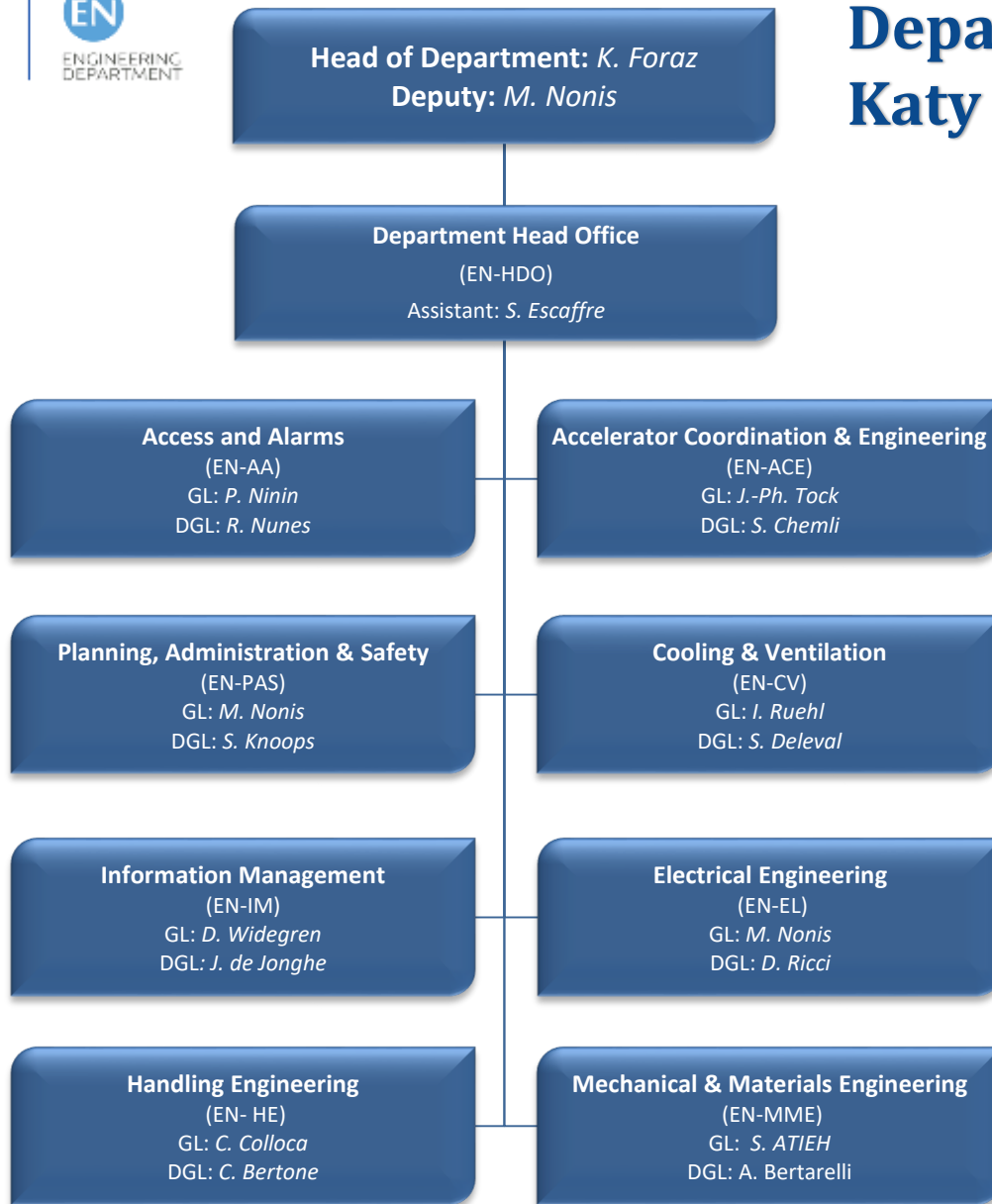

- Operation
 - Infrastructure
 - Accelerators
- Projects
 - Consolidation
 - Upgrades
 - New facilities
 - Design & Manufacturing
- Studies

Who are we in EN?

26 Nationalities

AT	BE	BG	CH	CZ	DE	DK	ES	FI	FR	GB	GR	HU	IE	IN	IT	NL	NO	PK	PL	PT	RS	SE	SK	TR	UA
4	22	2	20	1	10	3	33	7	185	15	9	1	1	2	46	4	1	1	15	18	2	2	1	1	1

Professional Category

Administrative work	3	4%
Office & Administrative work	14	
Scientific & Engineering Work	195	48%
Scientific Work (Experimental & Theoretical Physics)	3	
Technical work	195	47%
Manual work, Crafts & Trades	1	

F	M
15%	85%

Status

Cooperation Associates	3
Doctoral Students	3
Fellows	46
Project Associates	9
Staff	327
Technical Students	11
Trainees	12
TOTAL	411

MP age distribution

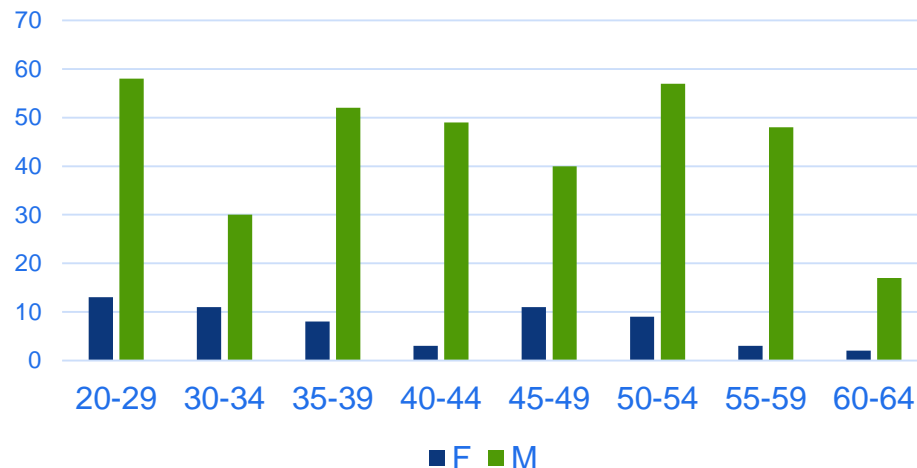

AA : Access and Alarms

The AA group is in charge of the specification, engineering, installation and maintenance of the systems that ensures the Safety of the CERN Personnel, Users and Visitors, on all its site and facilities.

The Safety Systems concerns:

- *Fire and Gas/ODH detection, emergency phones and evacuation, alarm transmission and monitoring,*
- *Interlocks to protect people radioactivity, X rays, lasers, electricity and cryogenics hazards,*
- *Access control to all CERN conventional or nuclear facilities and sites,*
- *Video surveillance, protection and intrusion detection,*
- *Access data management applications.*



Group Leader
Pierre Ninin

SPS-FIRE Safety Project: new automatic fire detection & fire protection

SPS-ACCESS Project: new access and safety system to the SPS underground areas

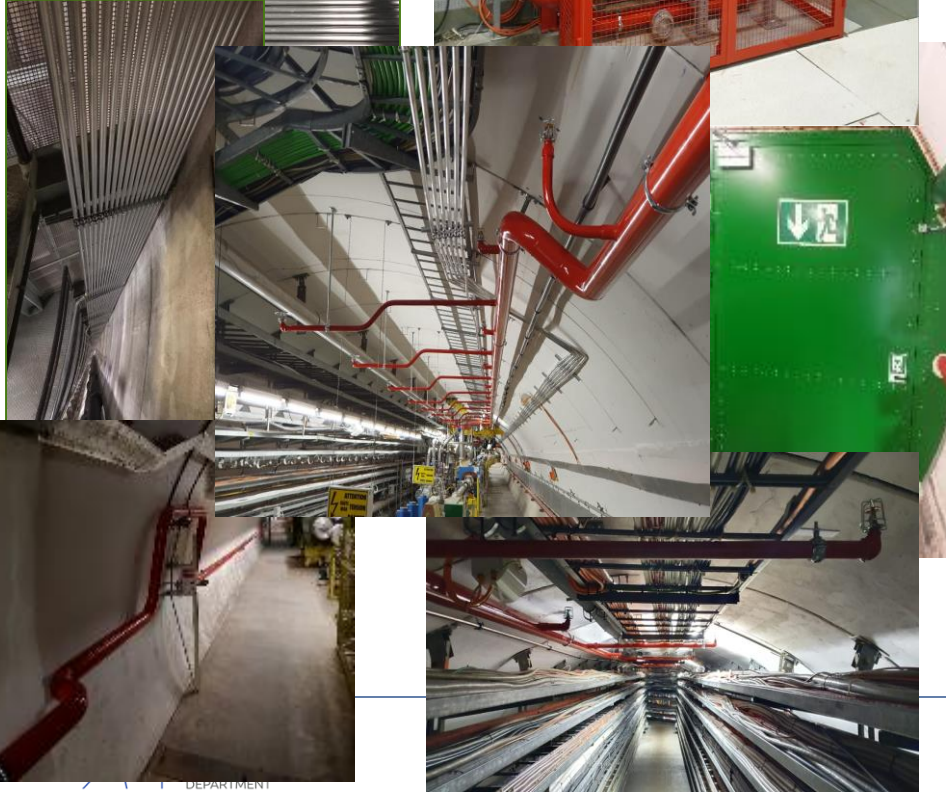
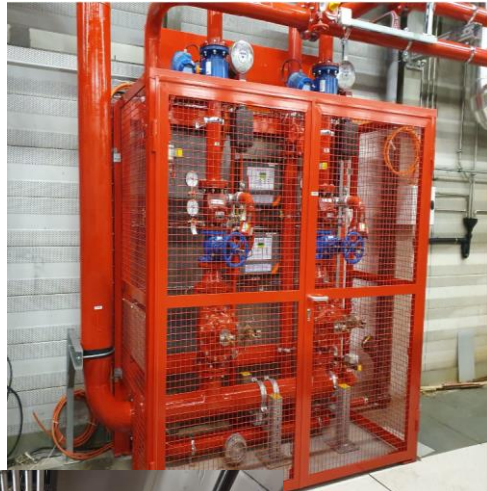

IM : Information Management

The IM group provides applications and support for engineering information management throughout the whole Organization and its different projects.

This includes for example mechanical CAD tools (such as CATIA), Product Lifecycle Management systems (Smarteam / Aras), the Engineering Data Management Service (EDMS) as well as the Enterprise Asset Management platform (Infor EAM).

The group helps implementing and configuring these tools according to user needs while ensuring that coherent processes are applied and provides user training.

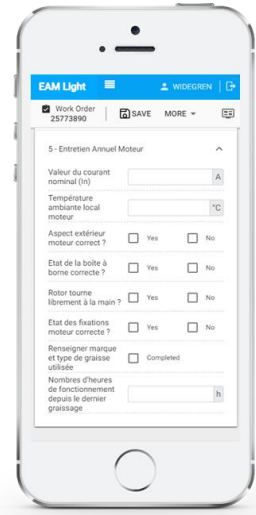
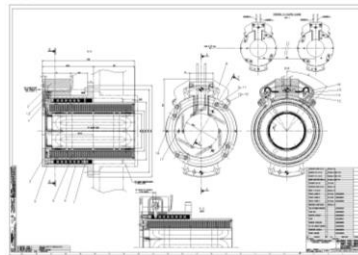
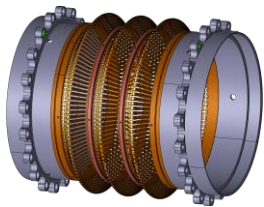

Group Leader
David Widegren

IM : Information Management

A key goal is to provide the tools required to manage and document the entire lifecycles of CERN's equipment and installations – also known as “Digital Thread”.

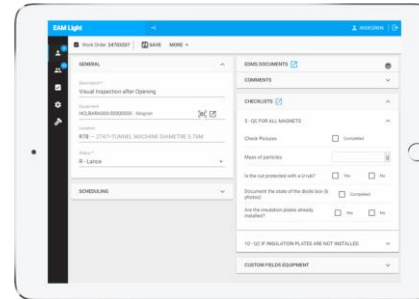
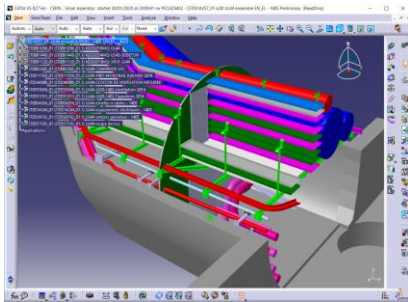
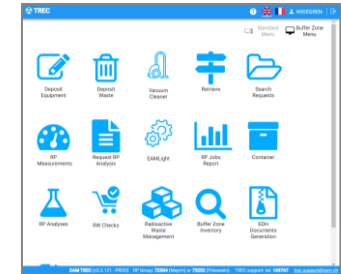
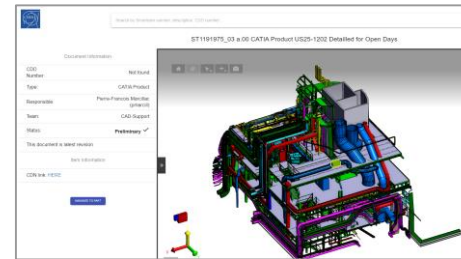
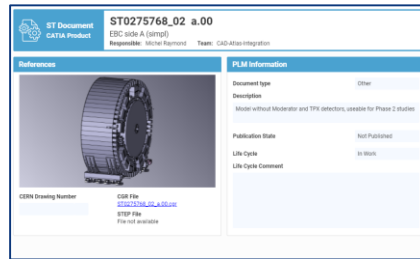
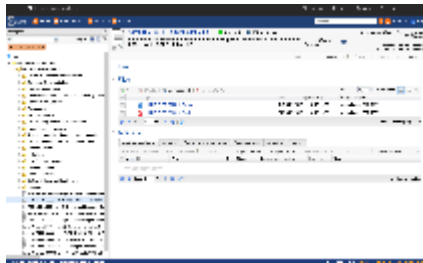

ACE : Accelerator Coordination & Engineering Group

The group coordinates the activities for the interventions and changes to the LHC and its injectors. This includes configuration & layout management, integration studies and maintenance of the related 3D-CAD representations, organization and scheduling of programmed stops, management of the mid- and long-term schedule, worksites follow-up and management of the LHC sites, management of electrical lock-out in LHC and operational safety coordination.

The group is responsible for the ATS Quality Service, giving support to the stakeholders of the ATS.

The group also provides support and/or advices in its key competencies.

Group Leader
Jean-Philippe Tock

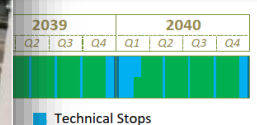
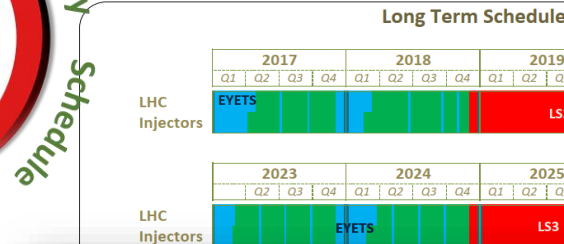

ACE : Accelerator Coordination & Engineering Group

Configuration, Layout, Naming and Integration

Specification Committee

- ▼ LHC Ring
 - ▼ Sector 12 (3001)
 - ▶ LSS R1
 - ▶ DS R1
 - ▶ ARC 12
 - ▶ DS L2
 - ▶ LSS L2
 - ▶ 7L2
 - ▶ 6L2
 - ▶ 5L2
 - ▶ 4L2
 - ▶ 3L2
 - ▶ 2L2
 - ▶ 1L2
 - ▶ VMGBA.B4L2.R
 - ▶ VMTBA.4L2.B
 - ▶ HEIWE.D4L2
 - ▶ TCTPH.4L2.B1
 - ▶ QRIOB.C4L2
 - ▶ BLMTL.B4L2
 - ▶ VAMTZ.4L2.B
 - ▶ VCRLP.4L2.R
 - ▶ PMIAM.D4L2
 - ▶ TCTPV.4L2.B1
 - ▶ HEIWE.C4L2
 - ▶ QRMPE.A4L2.Q

PROCUREMENT LIFECYCLE

Invitation to Tender
Technical Specification
Supply of Fine-Blanked Laminations
for Superconducting Magnets

Abstract
 This technical specification concerns the supply of about 17000 fine-blanked laminations about 12000 working up of kevlar-resin and 5000 made up of non-magnetic materials steel for the fabrication of superconducting accelerator magnets. Deliveries are foreseen over five years from the placement of the contract.

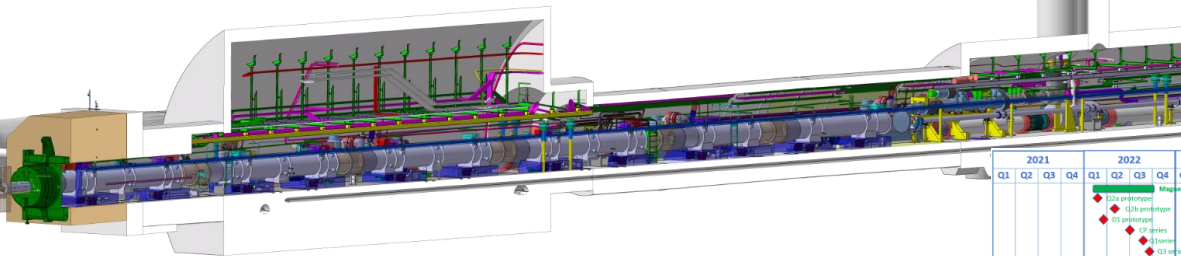

Organisation and Scheduling

2021				2022				2023				2024			
Q1	Q2	Q3	Q4	Q1	Q2	Q3	Q4	Q1	Q2	Q3	Q4	Q1	Q2	Q3	Q4
Dipole test & commissioning				Cryogenic infrastructure				Magnet ready							
				Mezzanine installation				Cold powering delivery							
				Service installation				Cold powering installation							
								Magnet installation on the STRONG							
								Instrumentation							
								Cooling							
								HVAC							

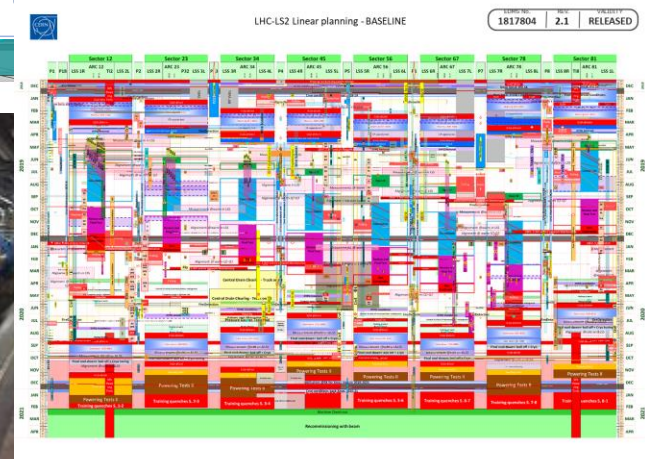
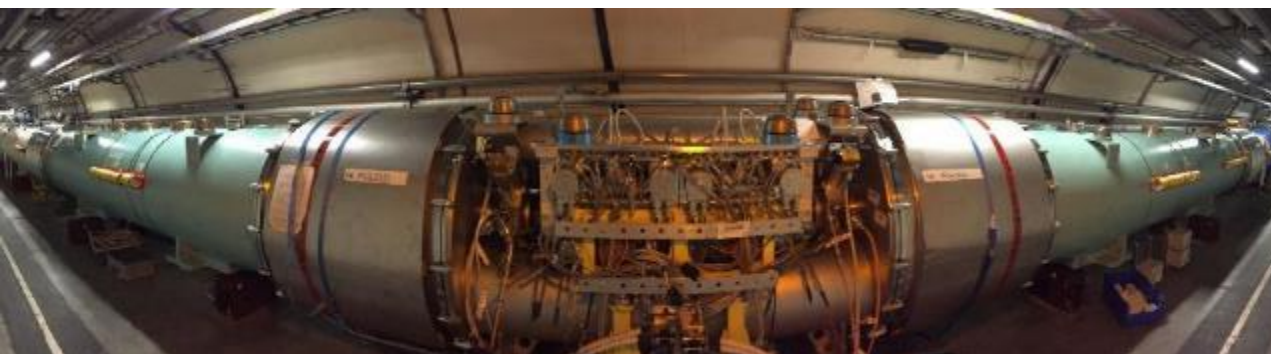
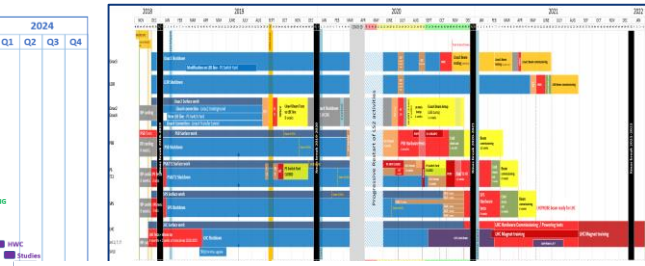

ACE : Accelerator Coordination & Engineering Group

Electrical lock-out



Quality Assurance Service

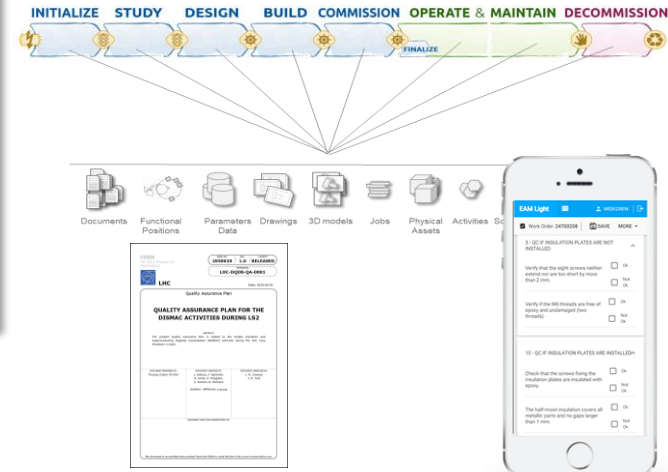

Operational Safety

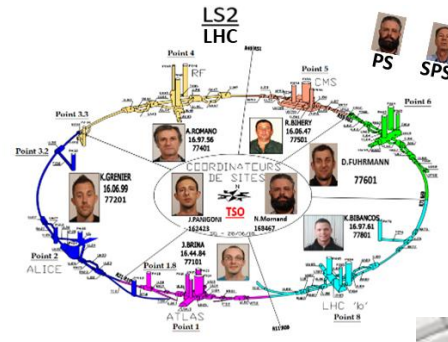

Worksite management

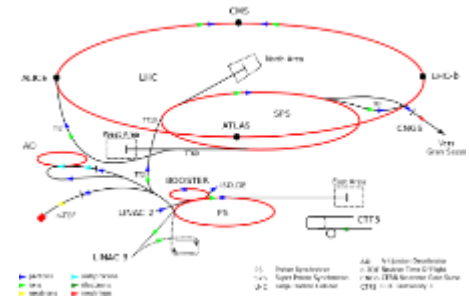

LHC SAFETY REMINDERS

- Lamp & Helmet
- Operational dosimeter ON
- Personal Dosimeter (CERN and company)
- CERN Card ODH Detector (ARCS)
- Self Rescue Mask
- Safety Shoes

No smoking Do not eat / drink



PAS : Planning, Administration and Safety

The group is responsible for supporting the Department Head in the management and planning of the department's **material and personnel resources**, as well as for all matters related to **safety and environment**. It represents the department in CERN-wide or inter-departmental bodies dealing with administrative, personnel, budget and safety matters. It also defines and implements safety and administrative procedures, for both the personnel and the material within the Department.



Group Leader
Mauro Nonis

People

CERN logo and Engineering Department logo. Document ID: 2444911, Version: 0.1, Status: DRAFT. Reference: EN-ARP/2019. Date: 2020-05-06.

REPORT

EN Department Manpower Plan 2020-2025

ABSTRACT:
This document describes the EN Department Manpower Plan 2019. It was ~~established~~ following a bottom-up information gathering from EN group leaders and a top-down calibration during an EN Department retreat held 15 January 2020.

DOCUMENT PREPARED BY: S. Kroops	DOCUMENT CHECKED BY: S. Legarde M. Bortone H. Brugger L. C. ... M. ... M. ... L. ... L. ...	DOCUMENT TO BE APPROVED BY: R. Lofsto
------------------------------------	---	--

PAS : Planning, Administration and Safety

OCTOBER 2020 EDMS 2430149

ENGINEERING DEPARTMENT
Safety Dashboard

Days **WITHOUT** accident: **23/31**

Number and type of events

	Handling	Tool	Workplace	Electricity	Vehicles	Radiation	Fire	Chemical
Accidents (Personnel + Material)	10	3	3	2	1	1	0	0
Near misses and Hazardous situations	8	0	0	2	5	0	1	0

Days lost: 30 | 208 | 776

This month: 2020 | 2019

Observation : The rate of hazardous situations declaration is improving. Please keep your vigilance!

Cumulative number of accidents

MESSAGE OF THE MONTH

- Check carefully all critical points related to a handling activity. **Handling remains an accident-prone activity.**
- 1/3 of accidents are hand related. **Keep always your hands away from sockets.**
- Declaring an electrical hazardous situation improves safety. **Serious accidents have been avoided.**

FLASH INFO ACCIDENT

Echafaudage en contact avec un jeu de barres

Site: Vista TSO
Obj: 2229 (EN)
Date: 14.10.2020 à 12:33
Rapport: 2430149, 2437994

I. FAITS

- Un intervenant de remplacement de câbles a débranché le TSO de la ligne.
- Les modifications sont consignées.
- Plusieurs échafaudages sont installés pour permettre l'entretien.
- Le poste des câbles est fermé.
- La proximité d'un jeu de barres est constatée dans le TSO.
- La responsabilité de ces faits est attribuée à une erreur de perception.
- La préparation des tests est effectuée.
- Le TSO est affecté une partie du bâtiment.
- Il n'est accepté que les échafaudages autorisés dans un contrat.
- Il est interdit de travailler sur les câbles.

II. CAUSES (5M)

- Méthode:
 - Aucun élément de méthode d'échafaudage n'a été vérifié par le superviseur des tests.
 - Lors de la pose de l'échafaudage, l'équipe a changé de la hauteur sans avertissement.
- Matériau:
 - Aucun élément de méthode d'échafaudage n'a été vérifié par le superviseur des tests.
 - Lors de la pose de l'échafaudage, l'équipe a changé de la hauteur sans avertissement.
- Manpower:
 - Une erreur de perception des câbles a été constatée lors de la mise en place des câbles.
 - Le TSO est affecté une partie du bâtiment.
 - Il est interdit de travailler sur les câbles.

III. CONSEQUENCES

- Dommages humains:
- Dommages matériels: Dommages potentiels: Risque électrique lors des tests dans le bâtiment.
- Événement déjà reporté dans le passé:

IV. ACTIONS PRISES

- Régularisation d'accidents (2437994).
- Régularisation d'entretien avec service échafaudage, service électrique, superviseur (1), TSO et ADD EN.
- Régularisation de l'entretien avec service échafaudage, service électrique, superviseur (1) et (2).

V. RECOMMANDATIONS (STOP)

- (1): (1):
- (2): Modification de l'échafaudage par l'équipe échafaudage à l'exception de l'échafaudage ne doit pas mettre à disposition un échafaudage pour un autre travail.
- (3): Rappel: le demandeur de l'échafaudage ne doit pas mettre à disposition un échafaudage pour un autre travail. Il est interdit de travailler sur les câbles.
- (4): Rappel: avant de commencer les travaux, les nouveaux contrôles de sécurité doivent être communiqués.
- (5): Rappel: avant de commencer les travaux, les nouveaux contrôles de sécurité doivent être communiqués.
- (6): Rappel: avant de commencer les travaux, les nouveaux contrôles de sécurité doivent être communiqués.

Decision

Téléphone: 2430149/2437994

Budget

Category	Jan	Feb	Mar	Apr	May	Jun	Jul	Aug	Sep	Oct	Nov	Dec
Material budget release	1st release			1	1	1						
Material plan				1	1	1						
Manpower plan				1	1	1						
Factsheets				1	1	1						
AFC				1	1	1						
Material PR				1	1	1						
Recurrent				1	1	1						

1st release

Carry-forward

MTP requests

APR bottom-up personnel

LD2C plan

Manpower

APR

MTP factsheets

PRE

les contractants

Sur la gestion de la sécurité dans le cadre des contrats du Département

Il y a quelques mois, vous trouvez lors de ce séminaire les réponses à vos questions, le retour d'expérience de la spécification technique, du plan de prévention, des modes opératoires et du suivi du contrat.

Améliorer les résultats sécurité du département.

Travailler avec la participation de IPT, HSE et d'un membre de l'équipe EROS.

NUMEROUS: ZHNElyDgYVWFM2d6mNRz00

CV: Cooling and Ventilation Group

The group is in charge of:

- Design, installation, commissioning, operation and maintenance of the cooling systems, pumping stations, air conditioning plants and fluid distribution systems of all accelerators, their experimental areas and some of the special cooling systems of LHC sub-detectors.
- Computational fluid dynamics (CFD) simulations, as well as studies on fluid dynamics, ventilation, heat transfer, smoke behavior, gas and radio nuclides propagation are performed by the group.



Group Leader
Ingo Ruehl



Cooling

Cooling plants (raw, demin. water, C ₃ F ₈ , C ₆ F ₁₄)	150
Pipelines	800 km
Hydrants	800 points
Cooling towers (450 MW)	22
Chilled water plants 6-12 °C (73 MW)	35
Water consumption (peak)	1'260 m ³ /h
Water network (3 pumping stations)	5'400 m ³ /h



*Equivalent to a small town of 25'000 inhabitants.
Annual consumption reduced by 40% in last 8 yrs.*



Ventilation

Heating, ventilation and air conditioning	> 1'500 units from 2'000 to 120'000 m ³ /h each
Compressed air	14 stations 200 km network

	km	m ³ /h
<i>Eurotunnel</i>	50	540'000
LHC	27	72'000



EL : Electrical Engineering Group

The mandate concerns the **electrical distribution network** from 400 kV to 400/230 V. Its main missions are to operate, maintain, extend and renovate the network, analyse and make projections for CERN electrical energy consumption and manage relations with the energy suppliers.



Group Leader
Mauro Nonis

Electricity Distribution

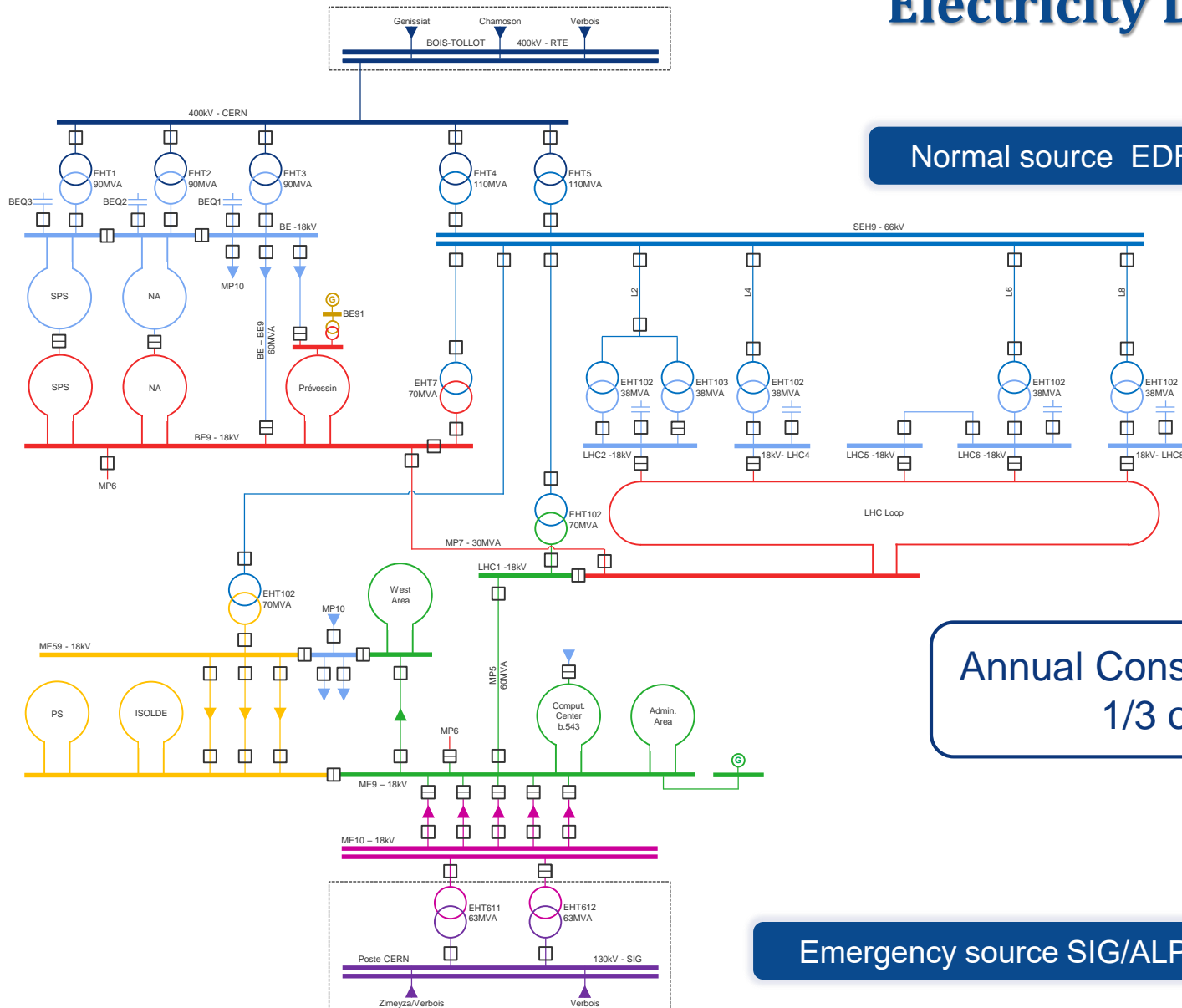

Normal source EDF > 200 MW

Annual Consumption 1.2 TWh
1/3 of Geneva

Emergency source SIG/ALPIQ ≤ 60 MW

EL : Electrical Engineering Group

The mandate also concerns the **cabling activities**. Its main missions are to install control cables, water cooled cables, and fibre optics for users. This activities include the management of infrastructures (cable trays, ducts, patch panels,etc.) and the necessary removal of old and unused installations.

EN-EL is also in charge of the controls of their distribution network.

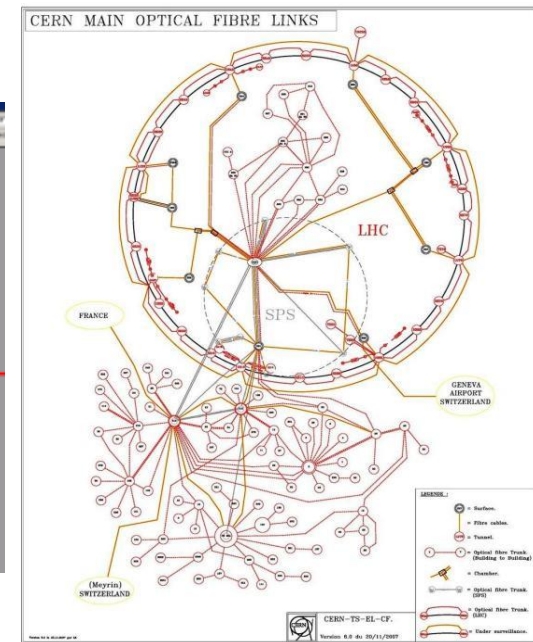
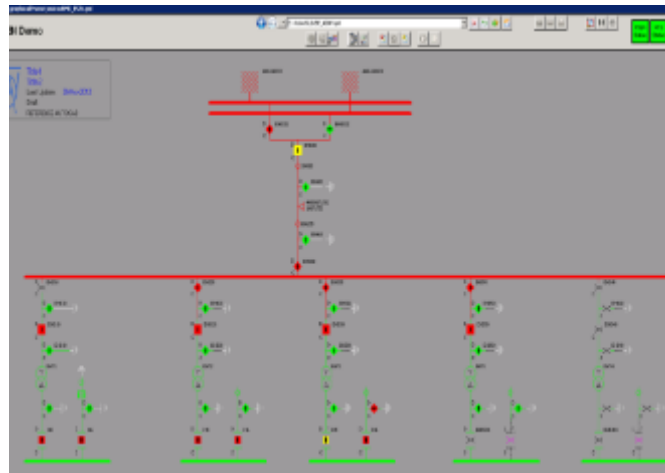

HE : Handling Engineering Group

From enormous pieces of equipment with unconventional shapes, to extremely delicate detector parts, the careful handling and transportation of components is essential at CERN.

The Handling Engineering (HE) Group prepares, organizes and coordinates all transport and handling operations for the CERN accelerators and experiments as well as the transport of thousands of conventional items, chemical and radioactive products per year.

The Group is specialized in the design, integration and feasibility studies related to the transport and handling operations. Both standard industrial and custom-built transport and handling equipment is being procured, installed and commissioned.

The Group manages and maintains all the industrial transport, handling and lifting equipment to ensure the perfect performance all along its lifecycle.

With the accelerator complex deep underground and about 700 buildings on surface, both passenger and goods lifts are very important. The HE Group is responsible for the purchase, installation and maintenance of all of them, regularly checking their performance.



Group Leader
Cristiana Colloca



HE : Handling Engineering Group

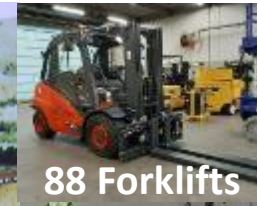

MME: Mechanical and Materials Engineering Group

The mandate of the MME group is to provide to the CERN community specific engineering solutions combining mechanical design, fabrication and material sciences, using in-house and industry facilities, for beam accelerator components and physics detectors.

➔ Prototypes and development work

Beam

Design

Measurements

Simulations

Fabrication & Assembly

Group Leader
Said ATIEH

MME : Domains of activities

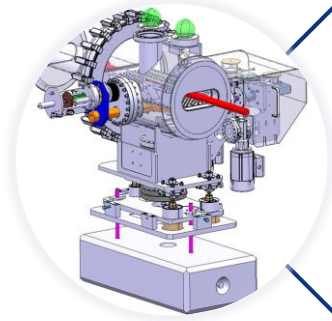

Design

- **Design Office**
 - 50+ designers and 15+ engineers
 - CATIA v5 / SmarTeam, ANSYS, LS-Dyna

- **Mechanical Measurements Lab.**

- **Mechanical workshop** (4000 m²)
 - 60+ technicians and 10+ engineers
 - CNC machining
 - Assembly & metal forming
 - Metal Additive Manufacturing
 - Welding (TIG, MIG, electron beam, laser, vacuum brazing)



Fabrication

- **Technical Subcontracting unit**

- **Material science consultancy**
 - metallurgical analyses, microscopy including FIB, mechanical tests
- **NDT:** UT, radiography, microtomography
- **Metrology:** 350 m² Lab., several CMM



Materials

What are our priorities?

Our priorities



SAFETY: What do we mean?

Occupational Health, Safety and Environmental protection

We mean...

- Put in place all possible measures to prevent:
 - Accidents
 - Illnesses
 - Impact to the environment

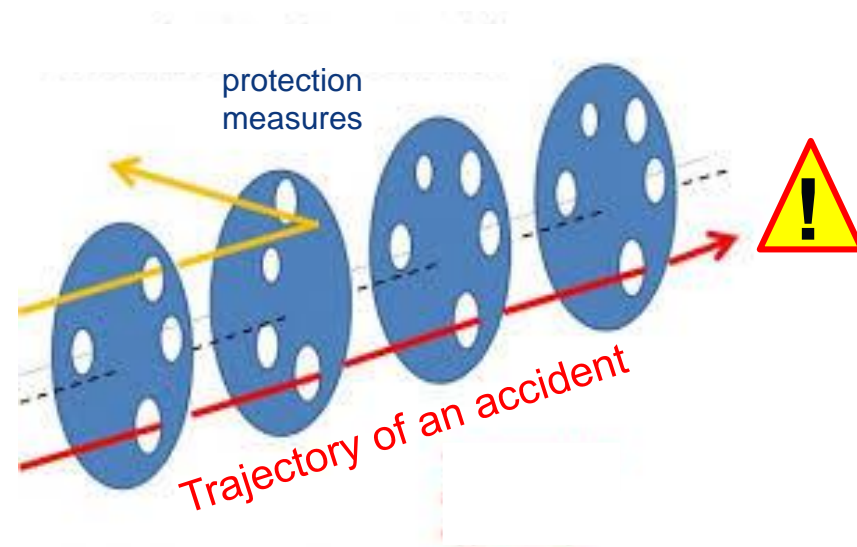

Reason Swiss Cheese Model

RESPONSIBILITIES

- The Director General takes appropriate measures to ensure safety of all participating in the activities of CERN or present in its site
- Each Member of Personnel shall actively contribute to the implementation of CERN Safety Policy through an exemplary conduct, in particular:
 - Comply with Safety Rules and Safety Objectives
 - Actively seek information to minimize risks
 - Avoid hazardous situations

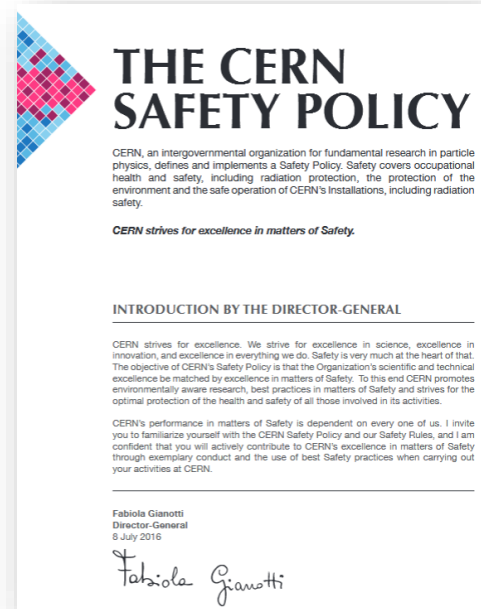

RESPONSIBILITIES in matters of safety **CANNOT BE DELEGATED**

MAGIC OF CERN

- Science is an extraordinary human endeavor
- Our understanding of nature at the fundamental level has reached astounding results
- The complexity of science requires a combined effort **technology + experiments + theory**
- CERN is a superb example of this combined effort at work

The scientific success of CERN belongs to all of us



ENGINEERING
DEPARTMENT

Warm welcome again!