



LHCOPN lambda and fibre routing – Episode 2

Michael Enrico
Network Engineering & Planning Manager
DANTE

LHC Meeting, Munich, 20.04.2007

LHCOPN – current status

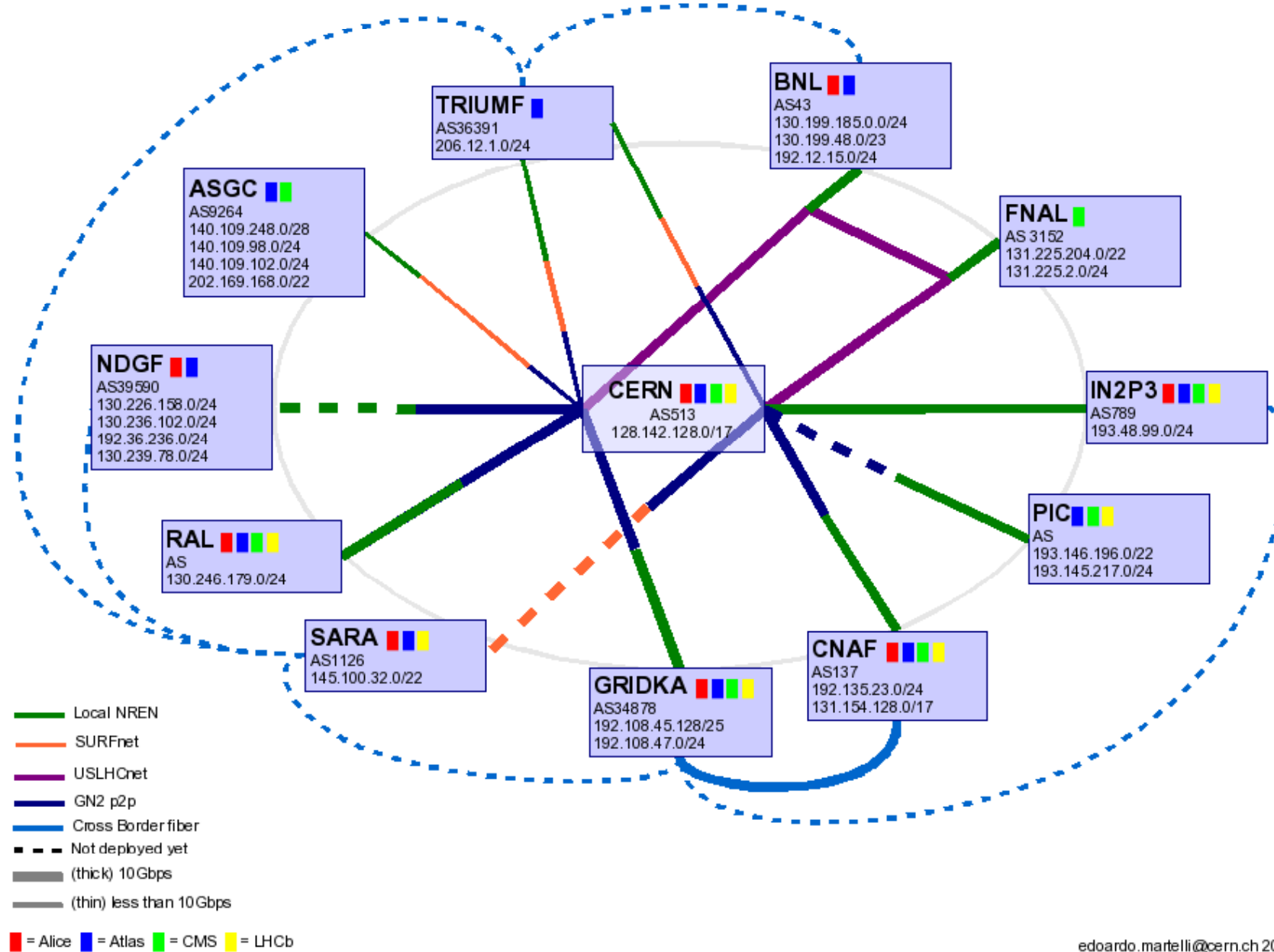

T0-T1 Lambda routing (schematic)

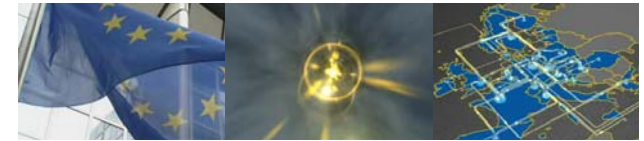

Connect. Communicate. Collaborate

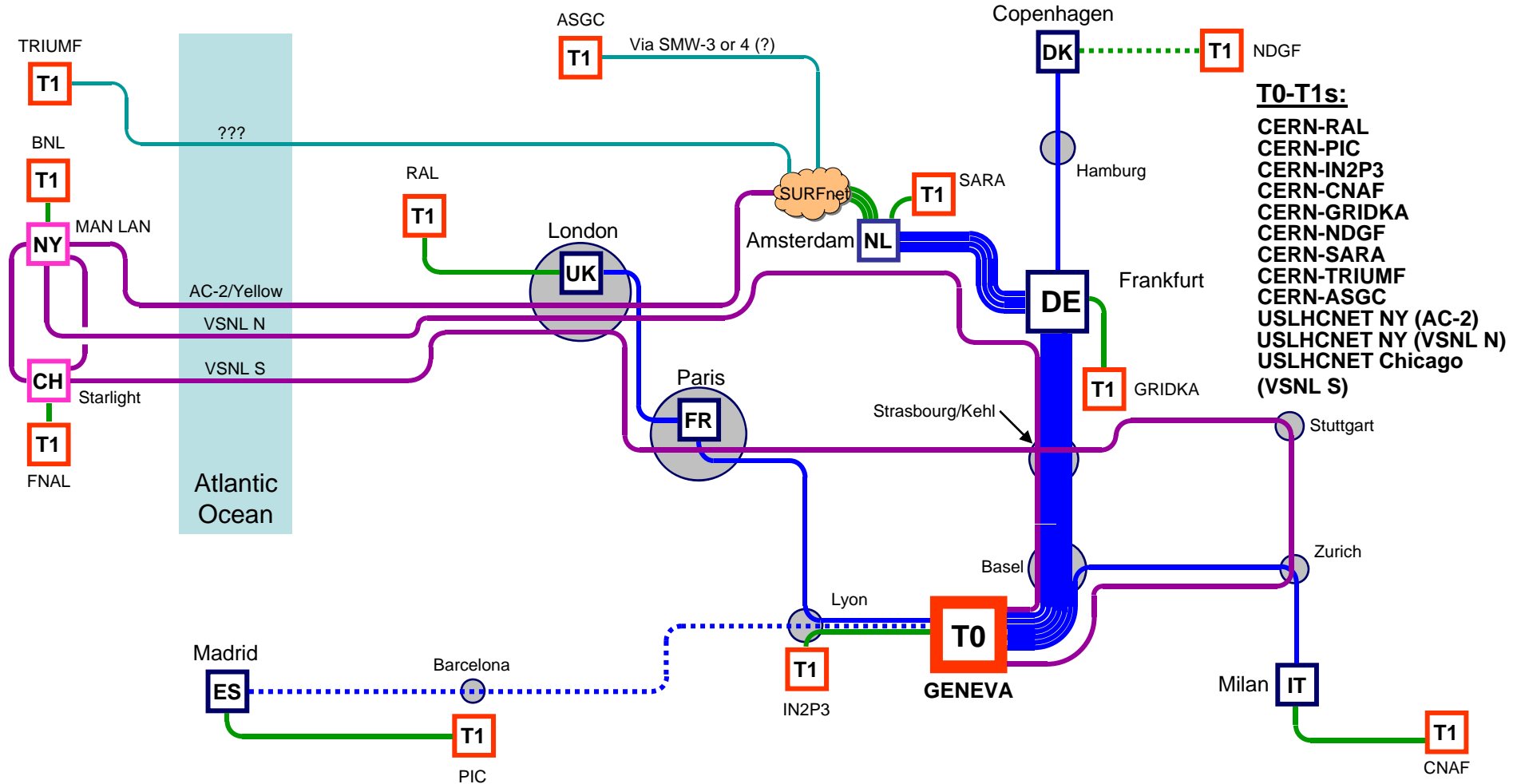

T1-T1 Lambda routing (schematic)

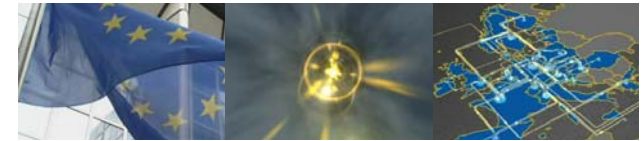

Connect. Communicate. Collaborate

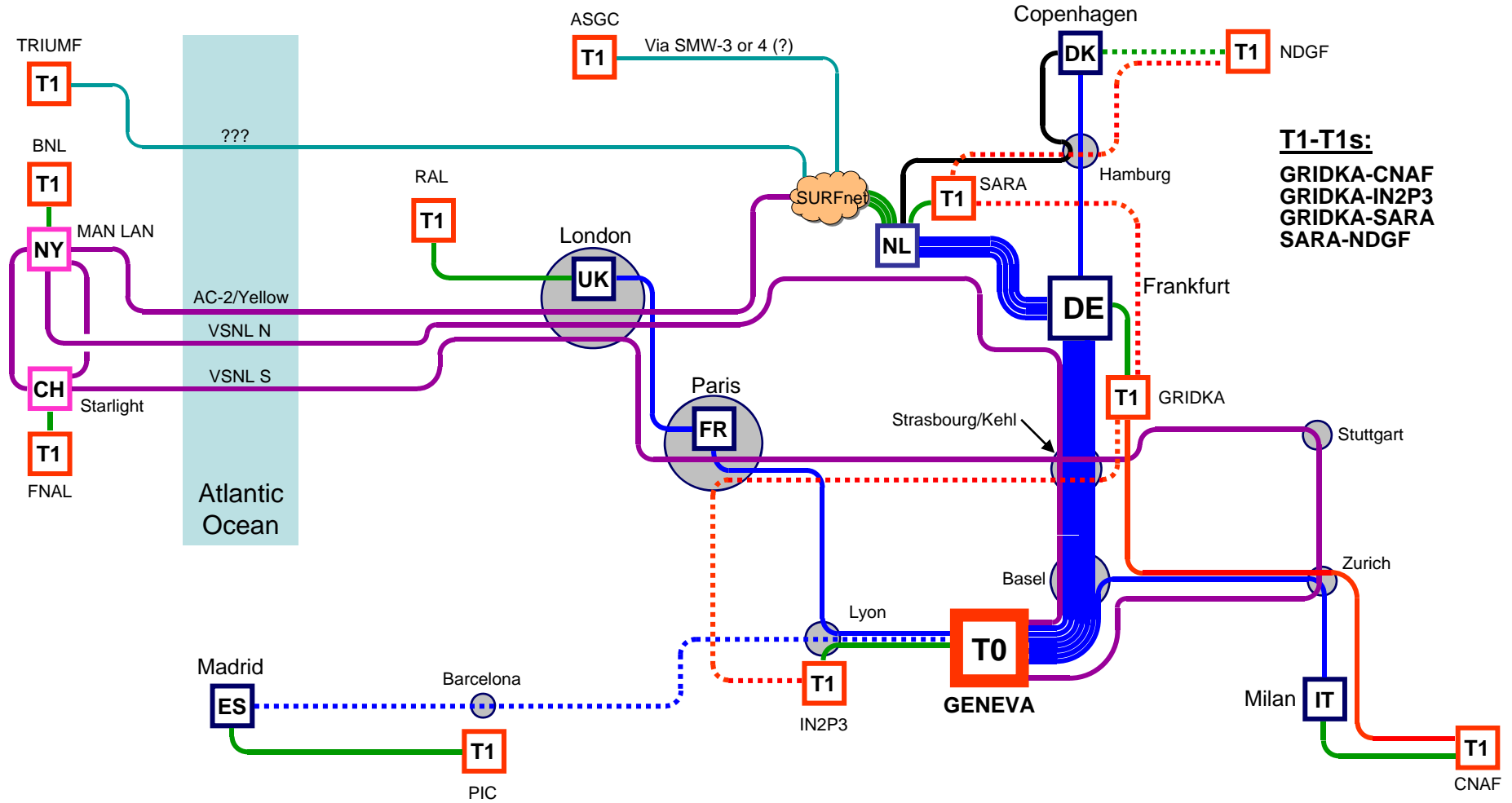

SRLG analysis

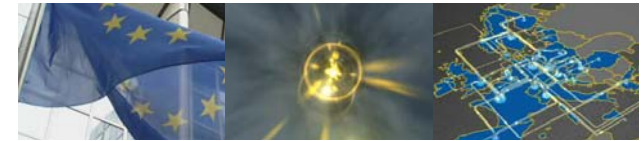

Connect. Communicate. Collaborate

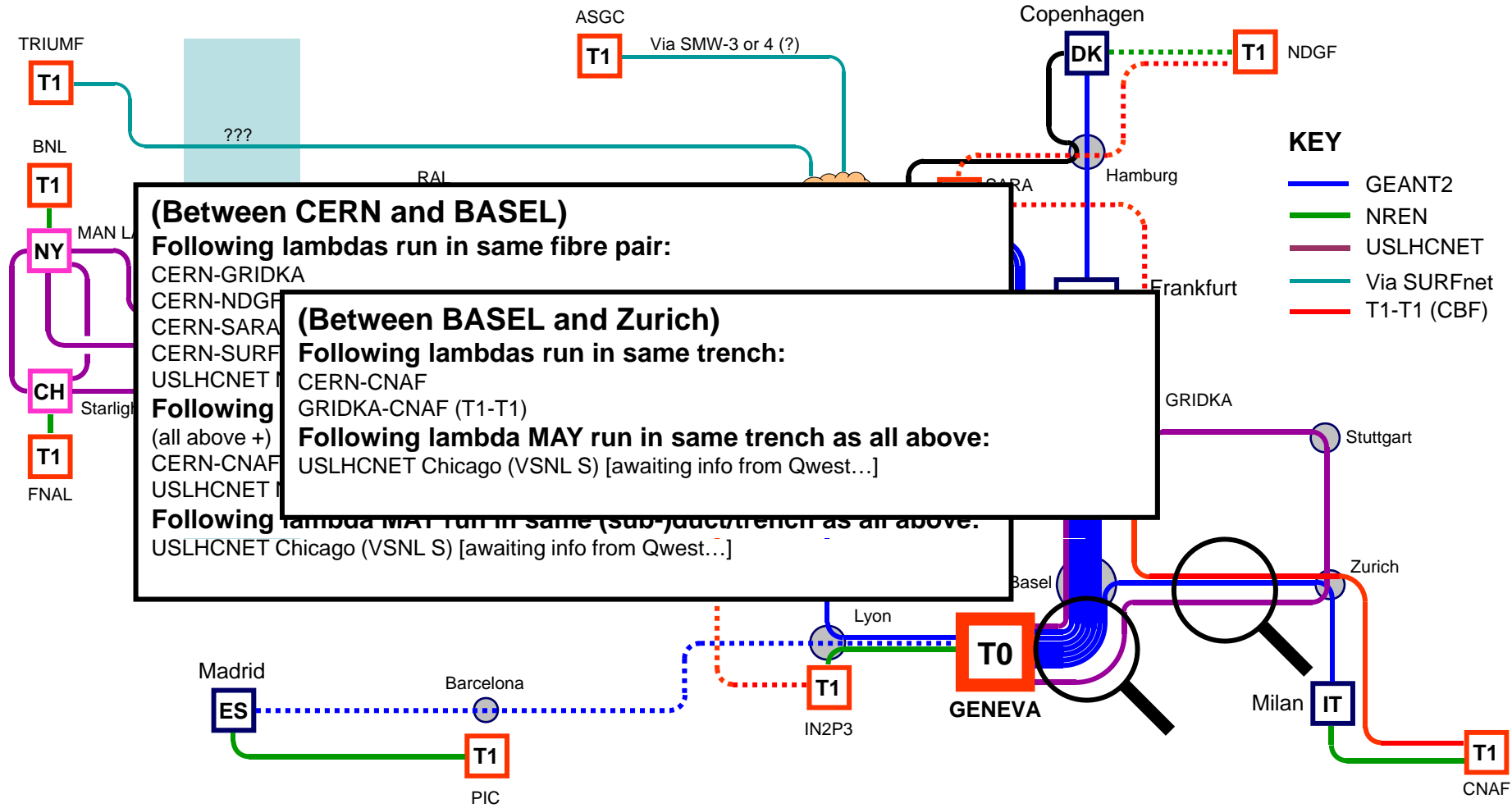

SRLG analysis (cont)

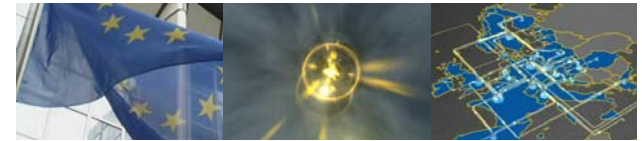

Connect. Communicate. Collaborate

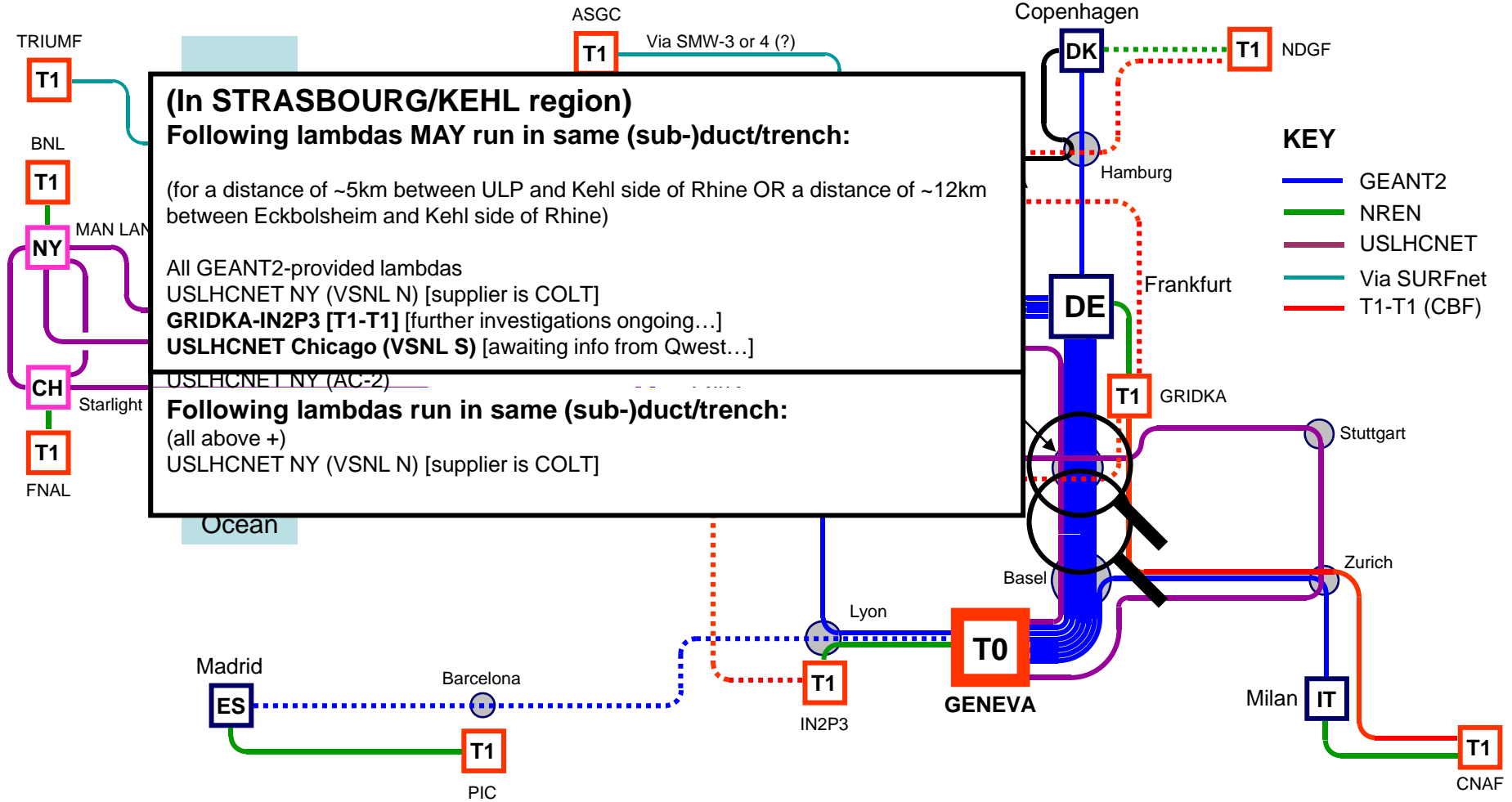

SRLGs analysis (cont)

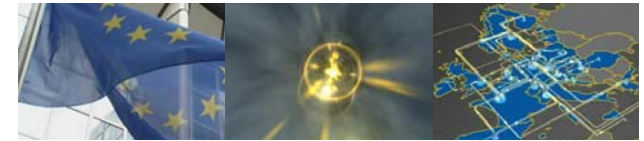

Connect. Communicate. Collaborate

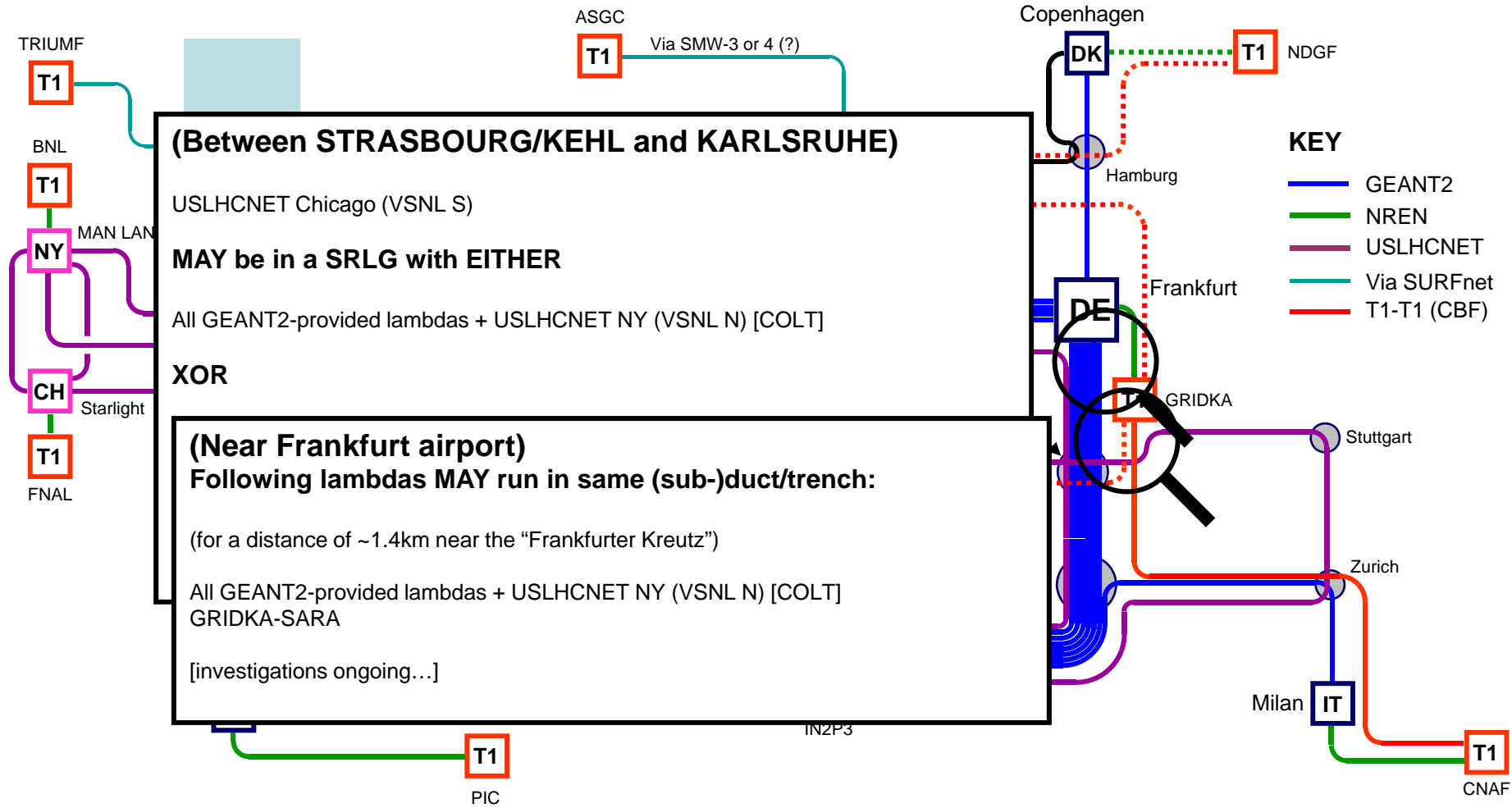

SRLGs analysis (cont)

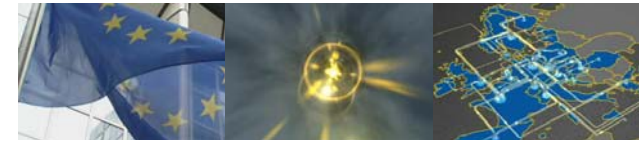

Connect. Communicate. Collaborate

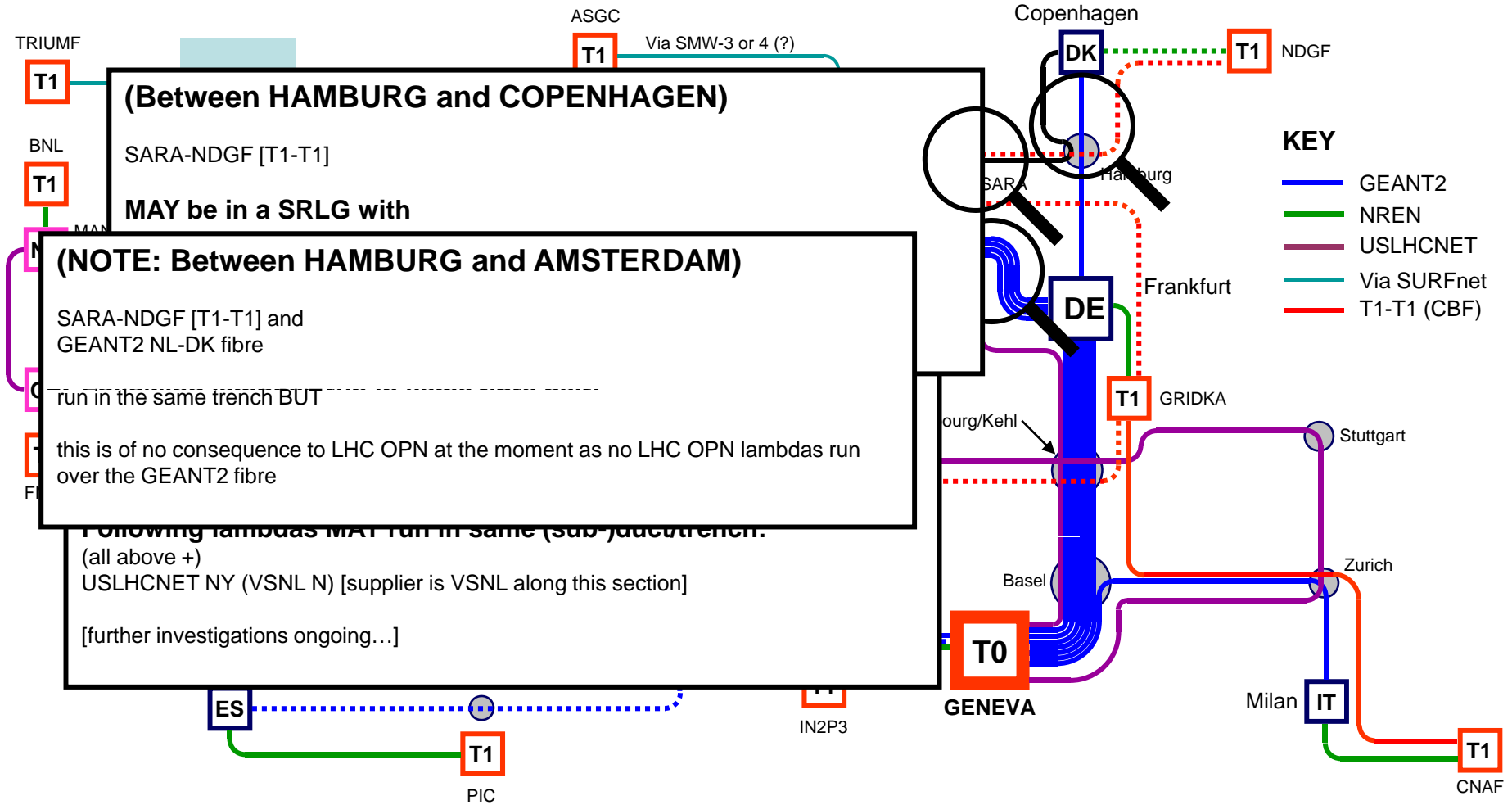

SRLGs analysis (cont)

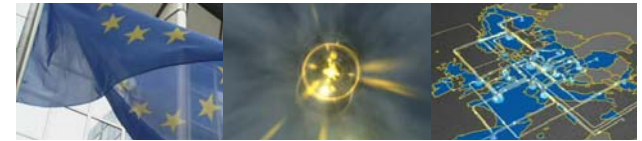

Connect. Communicate. Collaborate

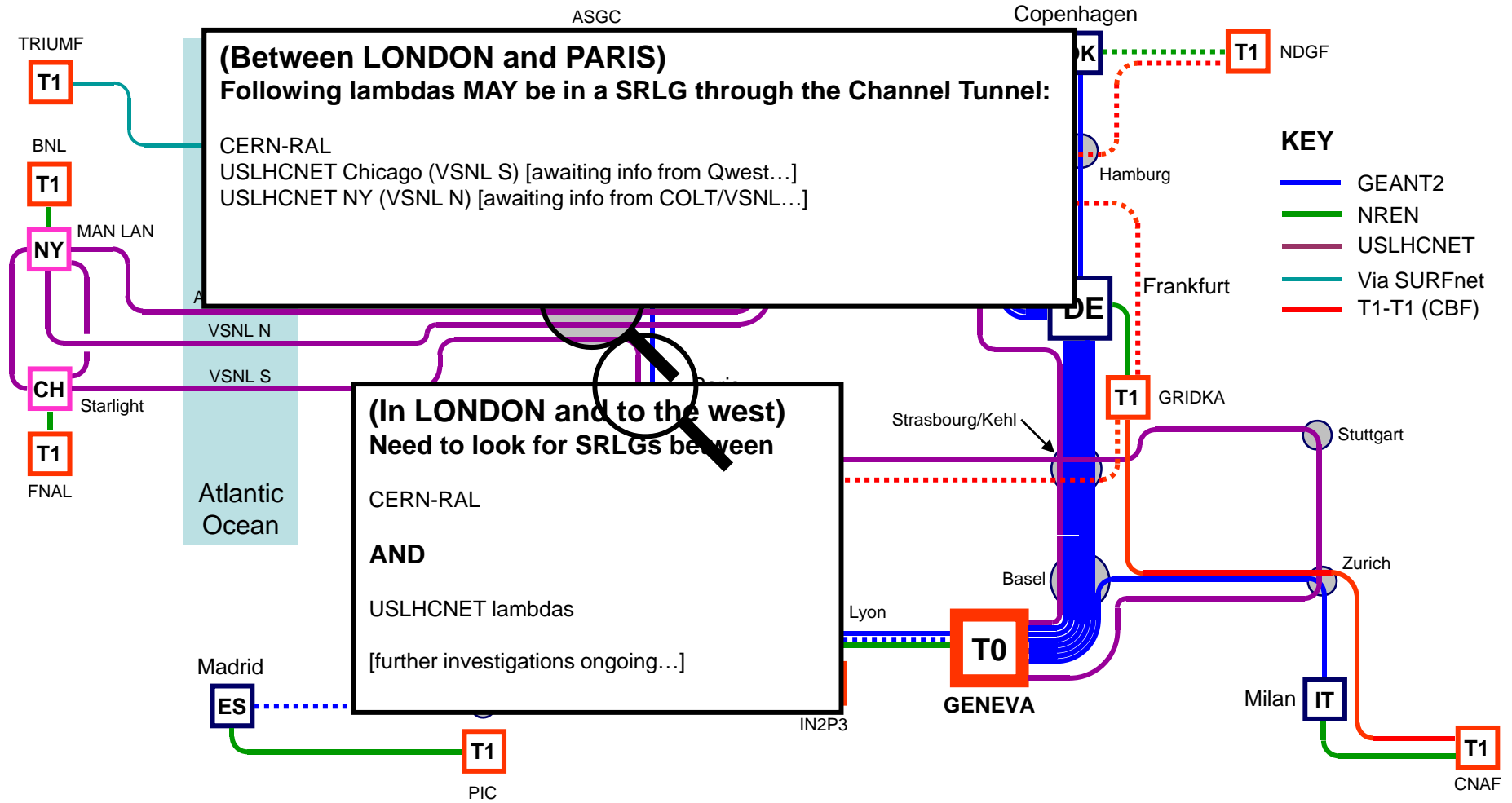

SRLGs analysis (cont, last two!)

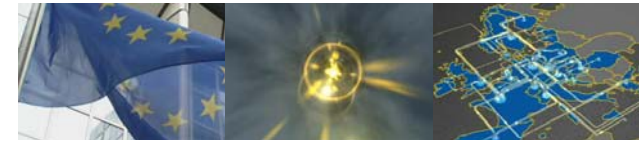

Connect. Communicate. Collaborate

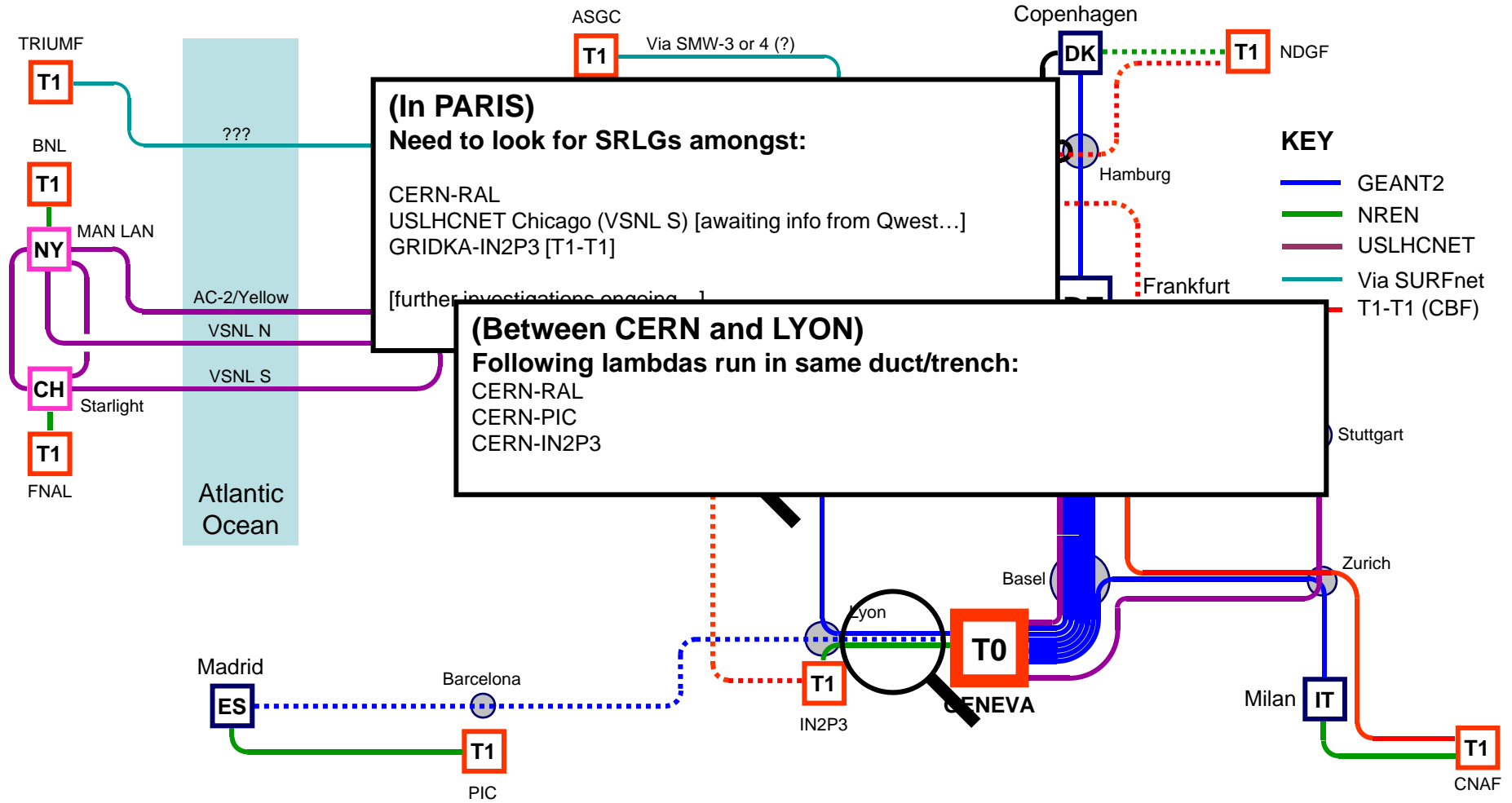



Connect. Communicate. Collaborate

Conclusions

- Obviously Basel-Geneva is very busy
 - Some lambdas can be brought in to CERN via Lyon (but at additional cost)
- Further investigations required in particular concerning:
 - Physical routing of Qwest USLHCNET lambda
 - Physical routing of GRIDKA-IN2P3 in Strasbourg/Kehl
 - Street level routing of GRIDKA-SARA (& GEANT2 fibre) near FFM airport
 - Physical routing of SARA-NDGF (Hamburg-Copenhagen)
 - Physical routing of COLT/VSNL USLHCNET lambda (VSNL N CLS-FFM)
 - Physical routing of GRIDKA-IN2P3 in Paris area
- Firmer conclusions will be drawn after these have been resolved