



www.cern.ch

Introduction to particle accelerators

[S. Gilardoni SY/STI](mailto:simone.gilardoni@cern.ch), simone.gilardoni@cern.ch



Exercises/questions....

- 1) During the LEP run (1996), two bottles of beer have been found inside the vacuum pipe.

In the LHC, neglecting the problem of finding a bottle that can fit in the aperture, **where would you place the bottle to minimise the emittance blow-up due to the multiple scattering** introduced by the glass (Consider the collision optics)? At one of the IPs? In one of the collimation sections? In one of the arcs? Motivate the solution

- 2) How many dipoles form the LHC lattice, knowing that at $p=7$ TeV each magnet has a field of $B=8.33$ T and a length of about $L=14.2$ m?
- 3) Compute the energy stored in the main dipoles at top energy, for an inductance of 98.7 mH and a current of 11850 A.
- 4) How many turns would take for a proton in the LHC to drop out of the LHC vertical aperture of 28 mm due gravitation ? The LHC revolution frequency is 11.245 kHz. Why it doesn't drop?

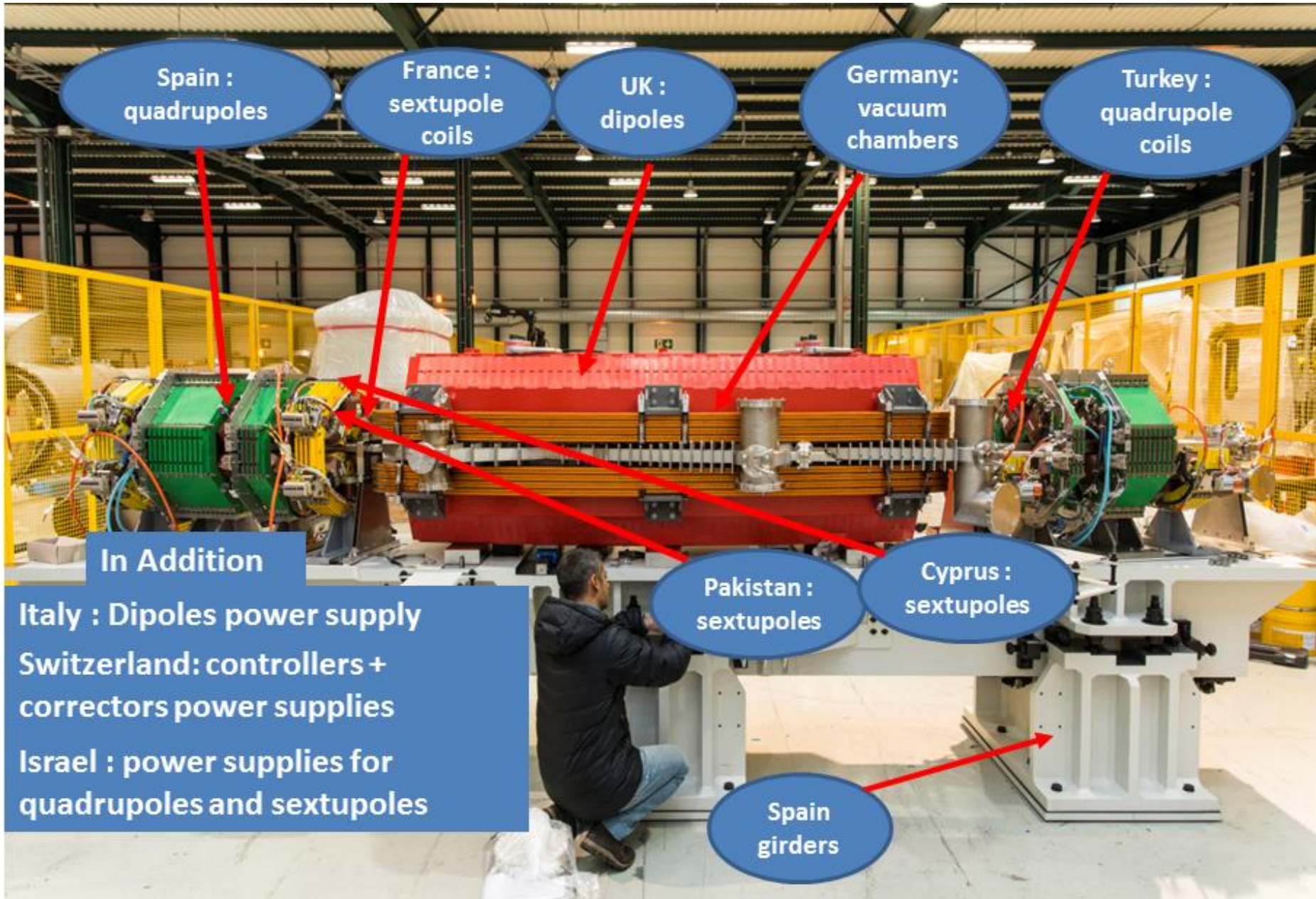

What are we doing today ?

<https://op-webtools.web.cern.ch/vistar/vistars.php>

PROTON PHYSICS: STABLE BEAMS

Energy: 450 GeV I B1: 1.11e+12 I B2: 1.33e+12

Inst. Lumi [(ub.s)^-1] IP1: 0.05 IP2: 0.05 IP5: 0.05 IP8: 0.00

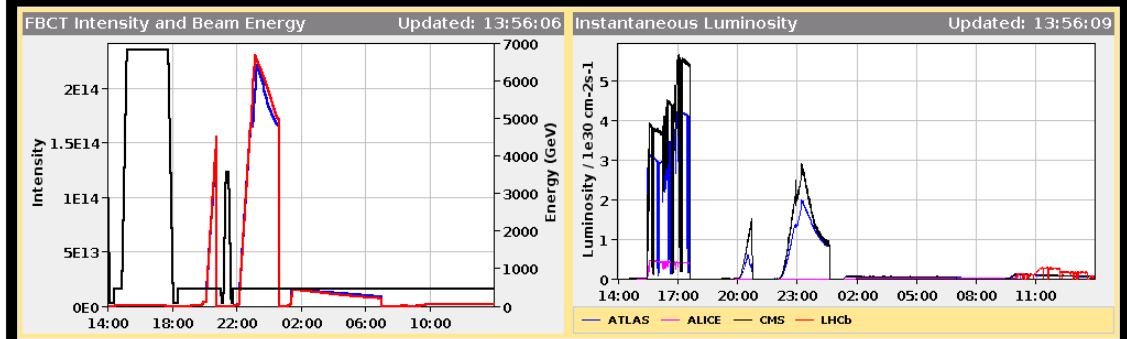

Comments (20-Jun-2022 13:19:22)
 ** STABLE BEAMS **
 16 bunches per beam, 8 collisions per IP
 gas injection at the BGC (point 4)
 we will keep this fill until ~14:00, then access
 AFS: Single_16b_8_8_noLR2

BIS status and SMP flags	B1	B2
Link Status of Beam Permits	false	false
Global Beam Permit	true	true
Setup Beam	false	false
Beam Presence	true	true
Moveable Devices Allowed In	true	true
Stable Beams	true	true
PM Status B1	ENABLED	ENABLED
PM Status B2	ENABLED	ENABLED

PROTON PHYSICS: INJECTION PHYSICS BEAM

I TI2: 8.33e+10 I B1: 3.19e+11 I TI8: 8.87e+10 I B2: 3.23e+11

TED TI2: BEAM TDISA B1 gap/mm: up: 8.15 down: 7.87

TED TI8: BEAM TDISA B2 gap/mm: up: 7.64 down: 7.71

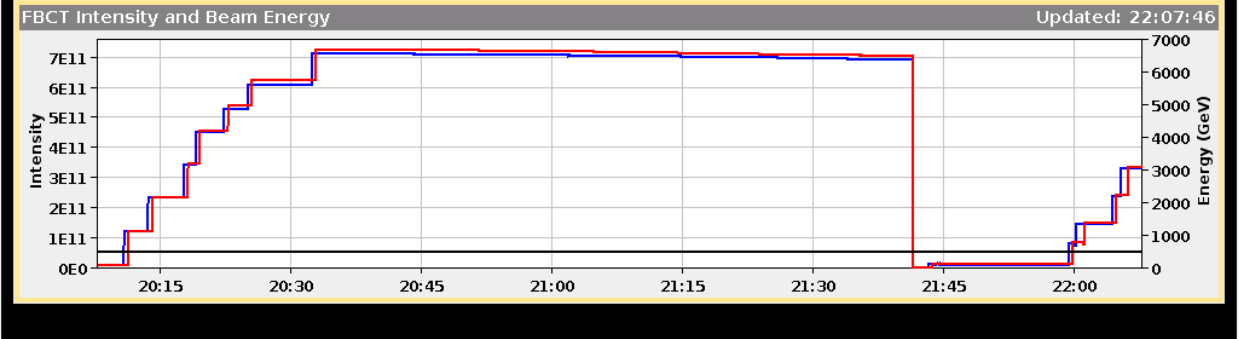

Comments (04-Jul-2022 20:55:59)
 BSRT calibration
 Next: Stable Beams at injection
 foreseen for ~2am
 AFS: Single_12b_9_1_3_BSRT_2018_pilot

BIS status and SMP flags	B1	B2
Link Status of Beam Permits	false	false
Global Beam Permit	true	true
Setup Beam	true	true
Beam Presence	true	true
Moveable Devices Allowed In	false	false
Stable Beams	false	false
PM Status B1	ENABLED	ENABLED
PM Status B2	ENABLED	ENABLED



LHC cycles: typical days (good and bad)

Dumped energy = **proton energy** × **beam intensity** at the moment of beam extraction

Good day:

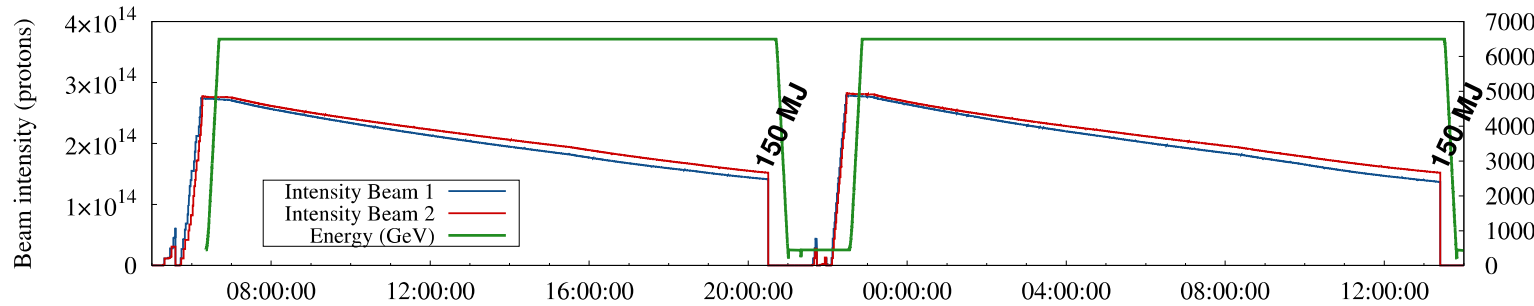

Bad day:

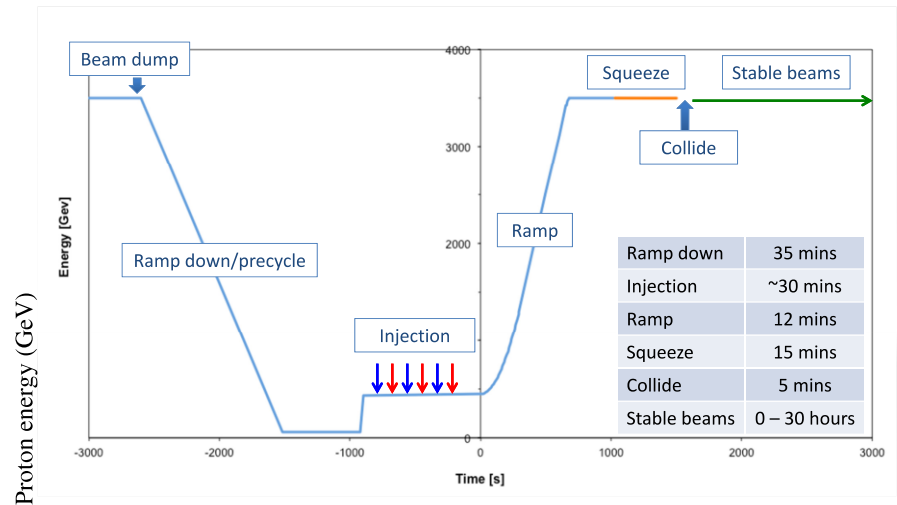
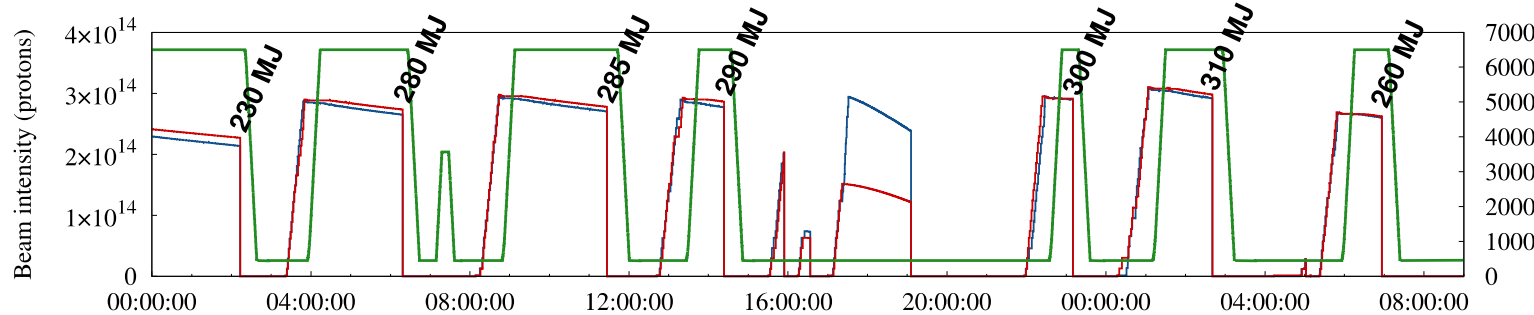

LHC Page1 Fill: 5282 E: 6499 GeV t(SB): 16:12:02 07-09-16 09:25:44

PROTON PHYSICS: STABLE BEAMS

Energy: 6499 GeV I(B1): 1.63e+14 I(B2): 1.68e+14

Inst. Lumi [(ub.s)^-1] IP1: 5097.01 IP2: 5.17 IP5: 5290.36 IP8: 369.43

FBCT Intensity and Beam Energy Updated: 09:25:43

Instantaneous Luminosity Updated: 09:25:44

Comments (07-Sep-2016 08:56:28)

fill for physics 2220 bunches
 Programmed dump at 9:30am
 Access: CMS and ALFA

BIS status and SMP flags		B1	B2
Link Status of Beam Permits		true	true
Global Beam Permit		true	true
Setup Beam		false	false
Beam Presence		true	true
Moveable Devices Allowed In		true	true
Stable Beams		true	true

AFS: 25ns_2220b_2208_1940_2036_96bpl_24inj PM Status B1: ENABLED PM Status B2: ENABLED

First question: what is the relationship between this, the moon, and a train?

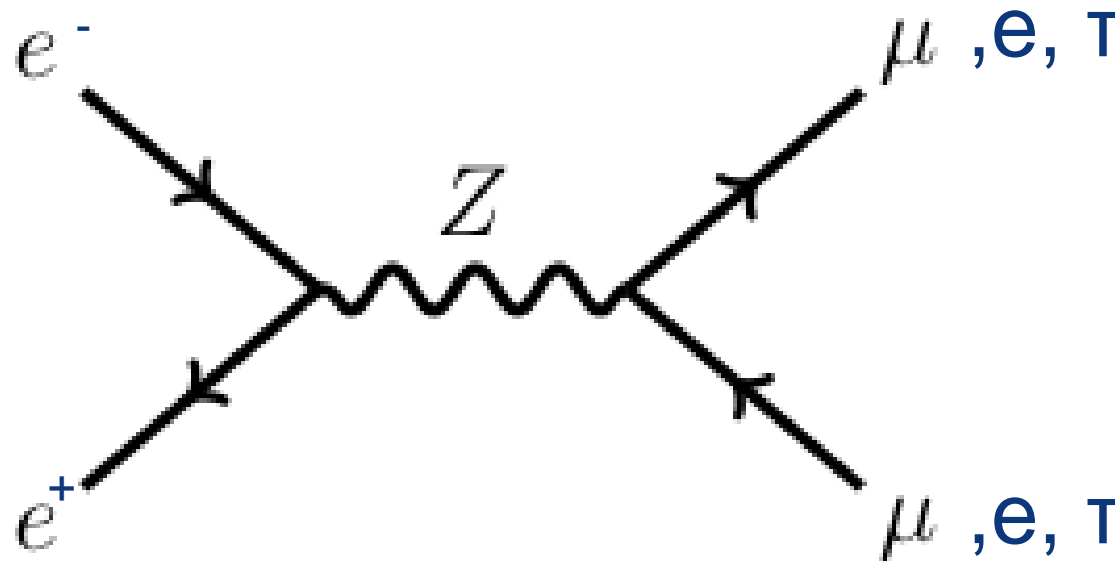
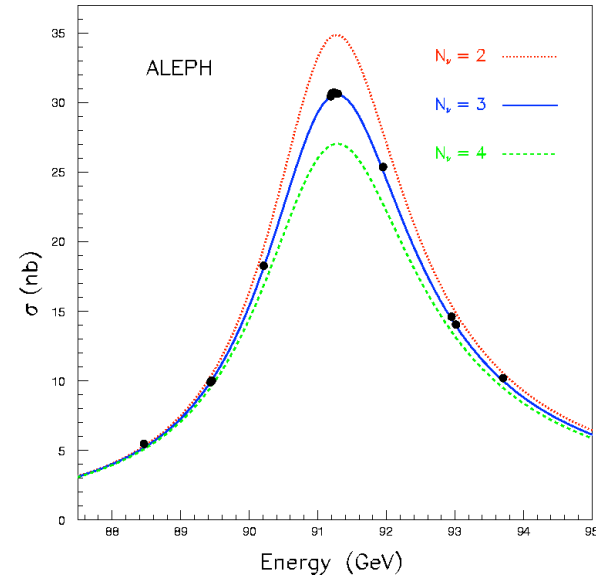

The “law” for these days : right hand rule

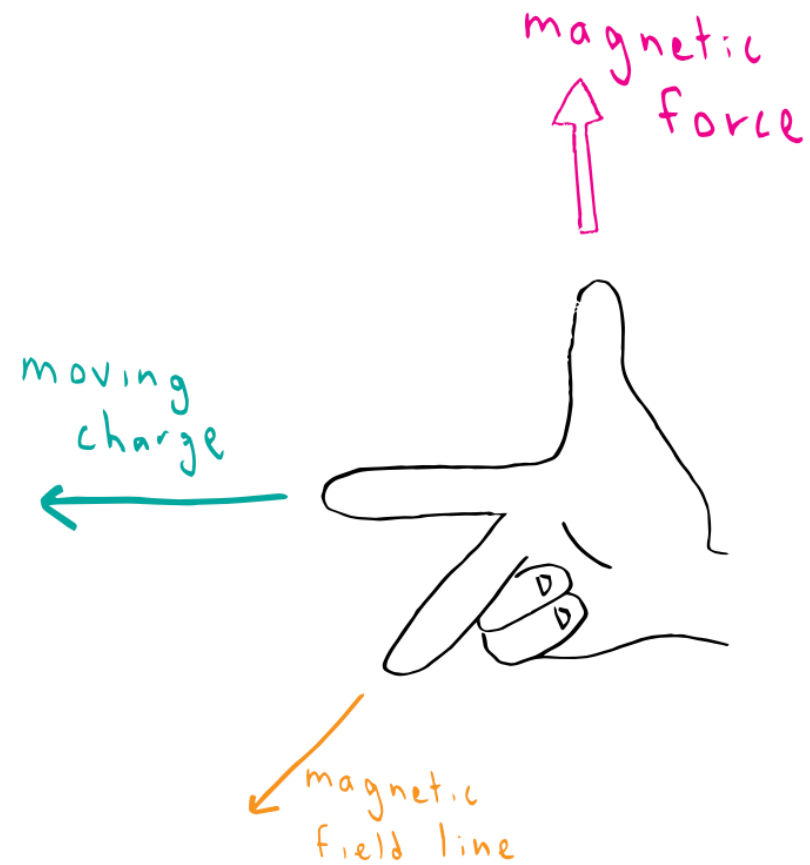

$$\overline{F}(t) = q \left(\overline{E}(t) + \overline{v}(t) \otimes \overline{B}(t) \right)$$

Interlude: a brief recall of energy scales

- **WARNING:** for purists or non-experts: Energy, Masses and Momentum have different units, which turn to be the same since c (speed of light) is considered equal to one.
 - Energy[GeV], Momentum [GeV/c], Masses [GeV/c²]
(Remember golden rule, $E=mc^2$ has to be true also for units...)
- Just as a rule of thumb: **0.511 MeV/c²** (electron mass) corresponds to about **9.109 10⁻³¹ kg**



An Example about energy scales: my cellular phone battery.

Voltage: 3.7 V

Height: 4.5 cm

proton mass ~ 1 GeV

To accelerate an electron to an energy equivalent to a proton mass:

1 GeV/3.7 eV = 270 270 270 batteries

270 270 270 batteries * 0.045 m ~ 12 000 000 m

12 000 000 m ~ THE EARTH DIAMETER



Obviously one has to find a smarter way to accelerate particles to high energies instead of piling up cellular phone batteries

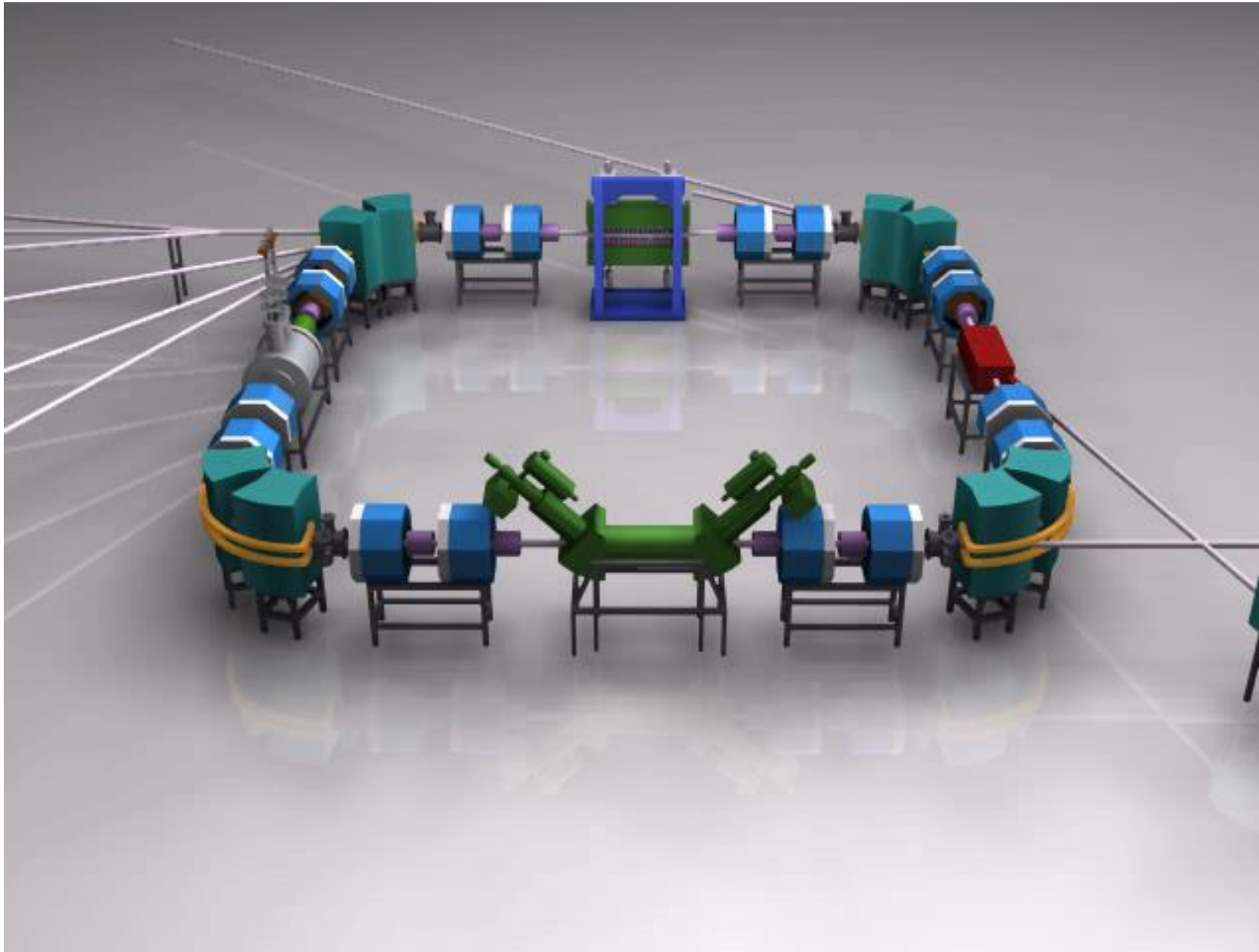

Building Blocks of an accelerator



1) A particle source

3) A series of guiding and storage devices

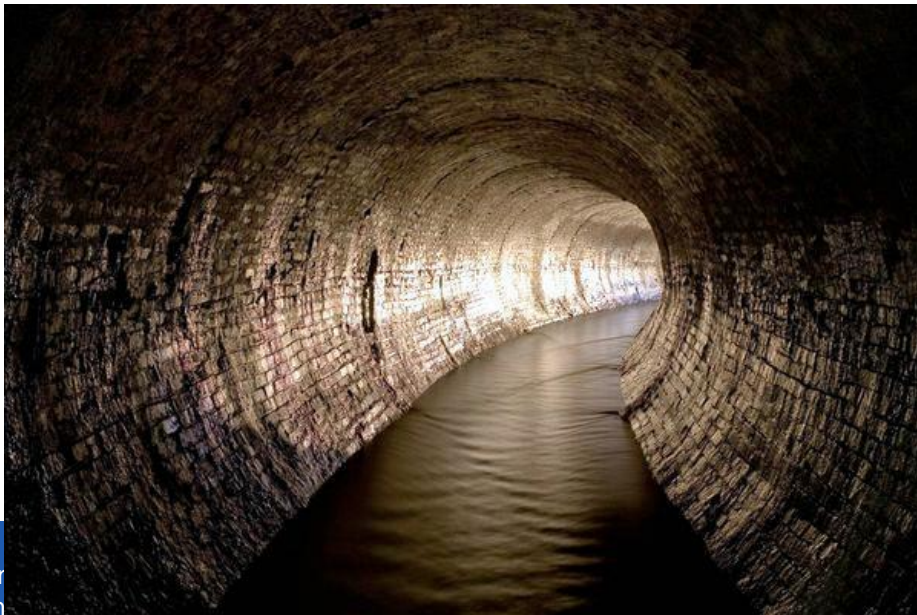

2) An accelerating system



Everything under vacuum



A Google view of high energy accelerators

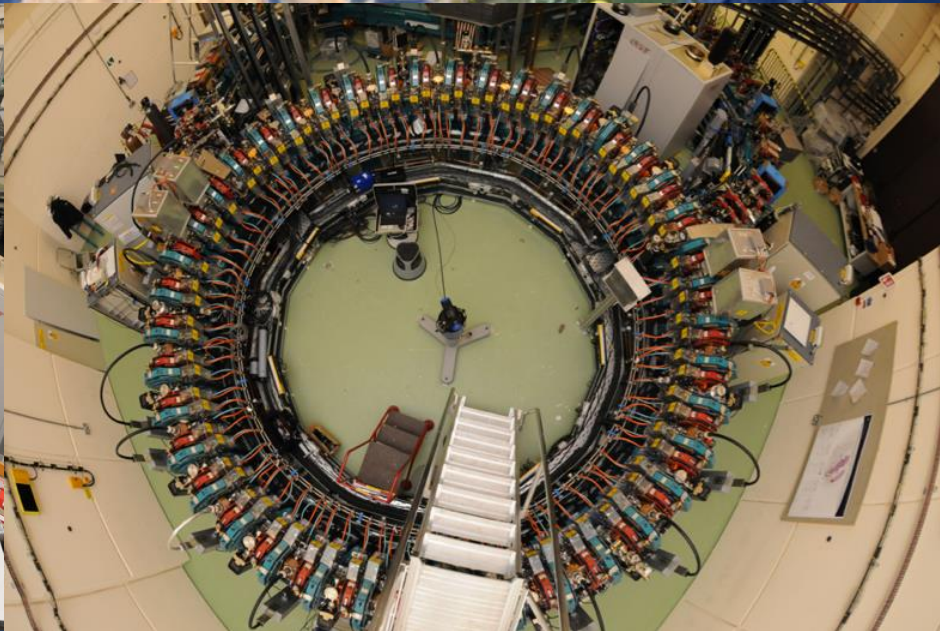
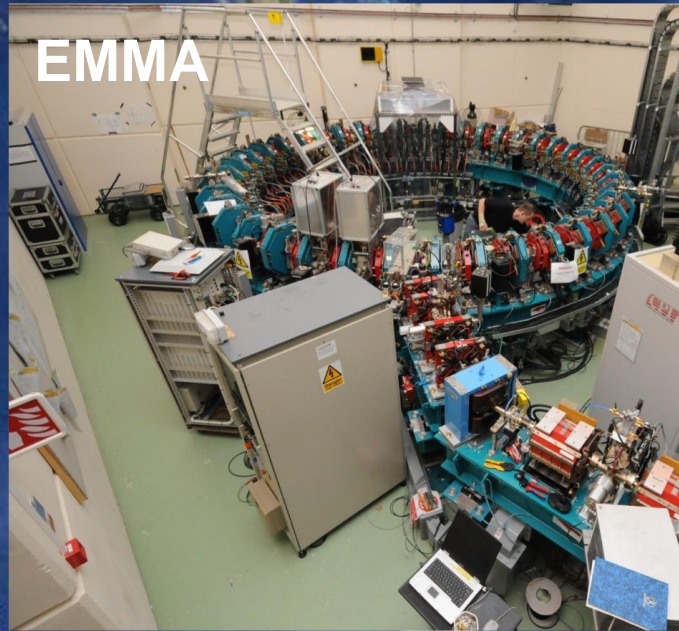

Where we are going to go

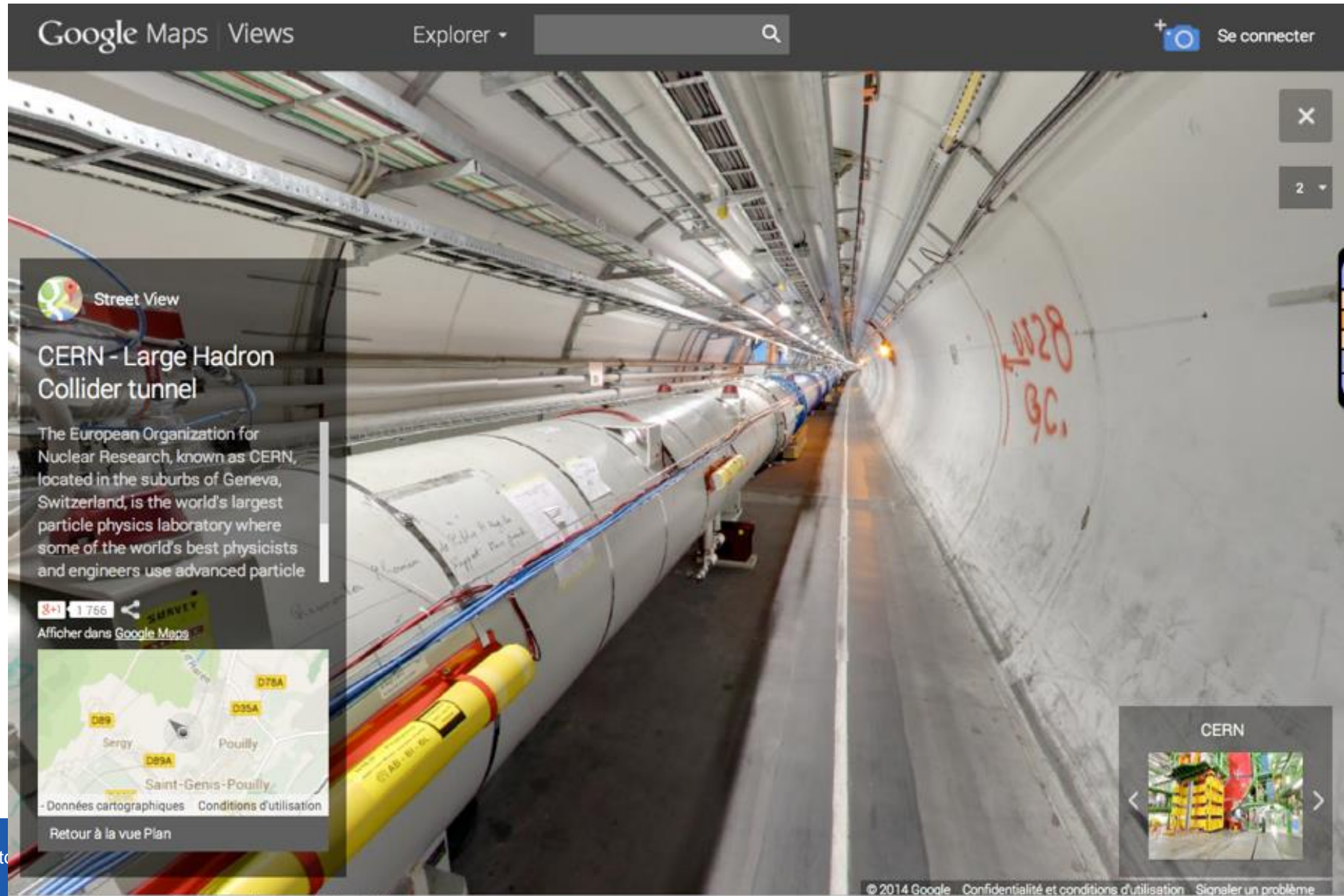

CERN accelerator complex overview

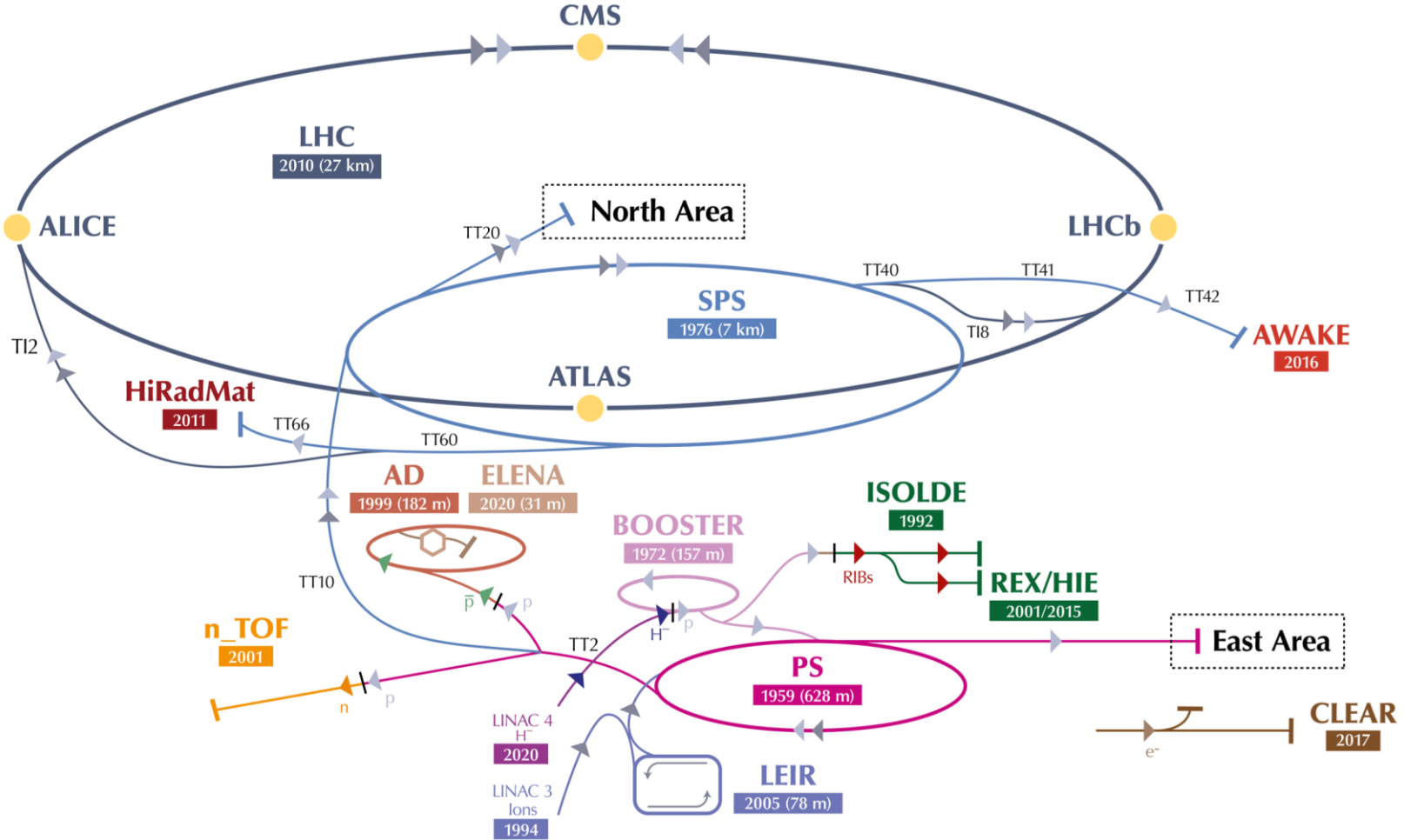

▶ H^- (hydrogen anions)
 ▶ p (protons)
 ▶ ions
 ▶ RIBs (Radioactive Ion Beams)
 ▶ n (neutrons)
 ▶ \bar{p} (antiprotons)
 ▶ e^- (electrons)



A view from the sky...



CERN accelerator complex as now

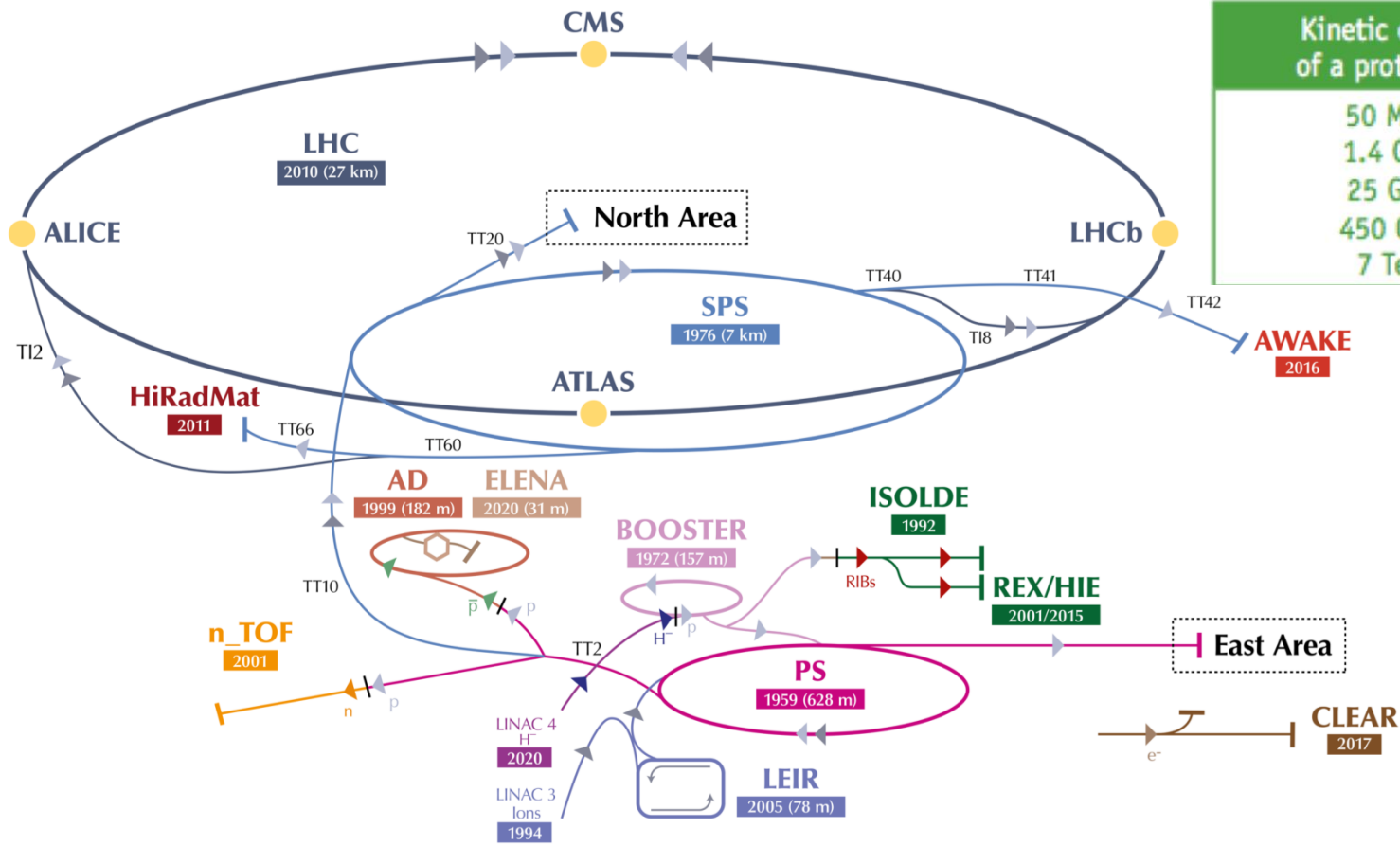

Kinetic energy of a proton (K)	Speed (%c)	Accelerator
50 MeV	31.4	Linac 2
1.4 GeV	91.6	PS Booster
25 GeV	99.93	PS
450 GeV	99.9998	SPS
7 TeV	99.9999991	LHC

▶ H^- (hydrogen anions) ▶ p (protons) ▶ ions ▶ RIBs (Radioactive Ion Beams) ▶ n (neutrons) ▶ \bar{p} (antiprotons) ▶ e^- (electrons)

Basically accelerators brings you ...

from nearly a bottle of hydrogen

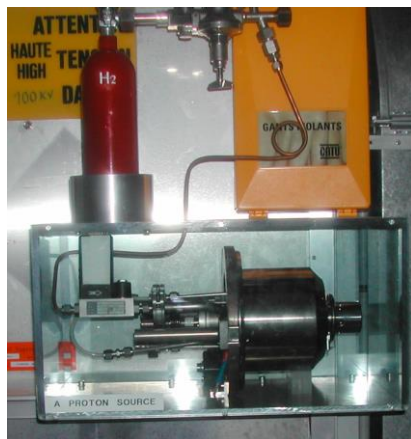

to a little bit before this

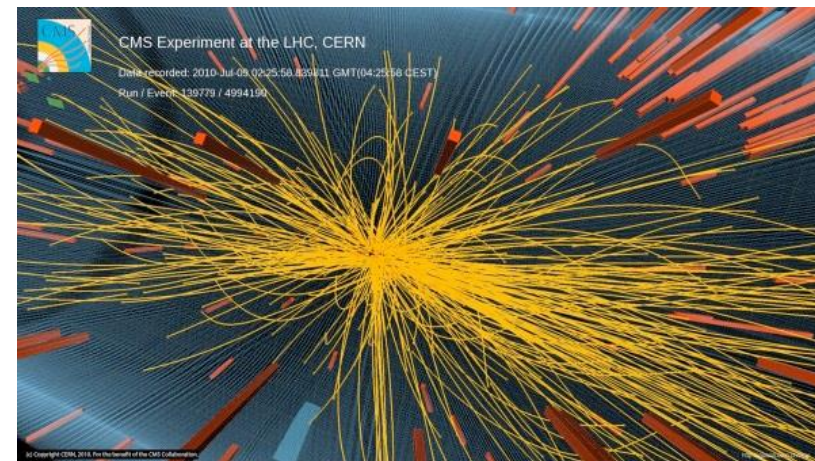

**How much time(distance) does it take from the source to collisions ?
(assumption, protons travels always at the speed of light)**

- In the Linac 4, basically nothing.
- In the **PSB**, a bit less than than 1.2 s.
- In the **PS**, a bit less than 3.6 s
- In the **SPS**, a bit less than 16.8 s
- In the **LHC**, minimum 30 minutes



1 821.6 s → 546 480 000 km

about 3.7 time the distance Sun-Earth

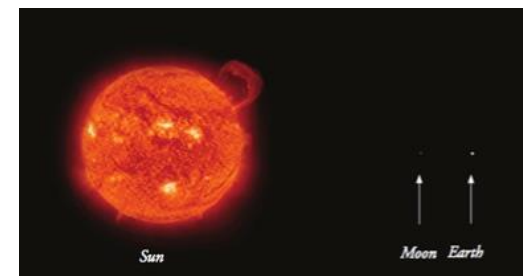

How long does it takes a turn in the LHC ?

89 microseconds → 1 LHC turn

5 milliseconds – a honey bee's wing flap OR ~ 56 LHC turns

The average human eye blink takes 350 milliseconds OR ~ 3930 LHC turn

Why particle accelerators ?

- ▶ *Why accelerators?*: need to produce under controlled conditions HIGH INTENSITY, at a CHOSEN ENERGY particle beams of GIVEN PARTICLE SPECIES to do an EXPERIMENT
- ▶ An experiment consists of studying the results of colliding particles either onto a fixed target or with another particle beam.

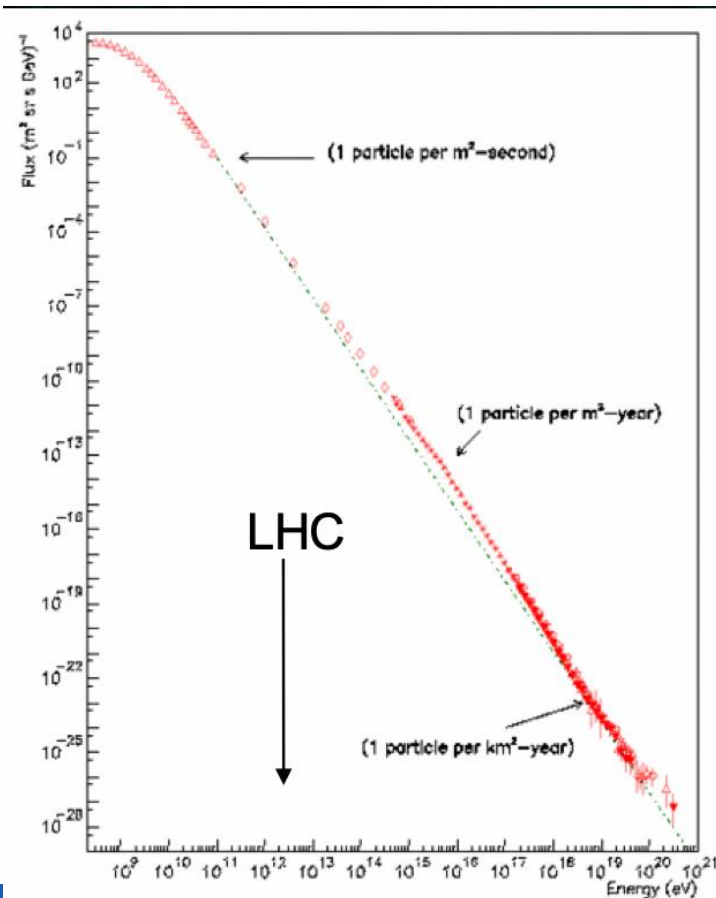

The cosmos accelerates already particles more than the TeV
While I am speaking about $66 \cdot 10^9$ particles/cm²/s are traversing your body, about 10^5 LHC-equivalent experiment done by cosmic rays
With a space distribution too dispersed for today's HEP physics!



To accelerate particles, nature can count on exceptional phenomena

Like supernova explosions...



History/Energy line vs discovery potentials

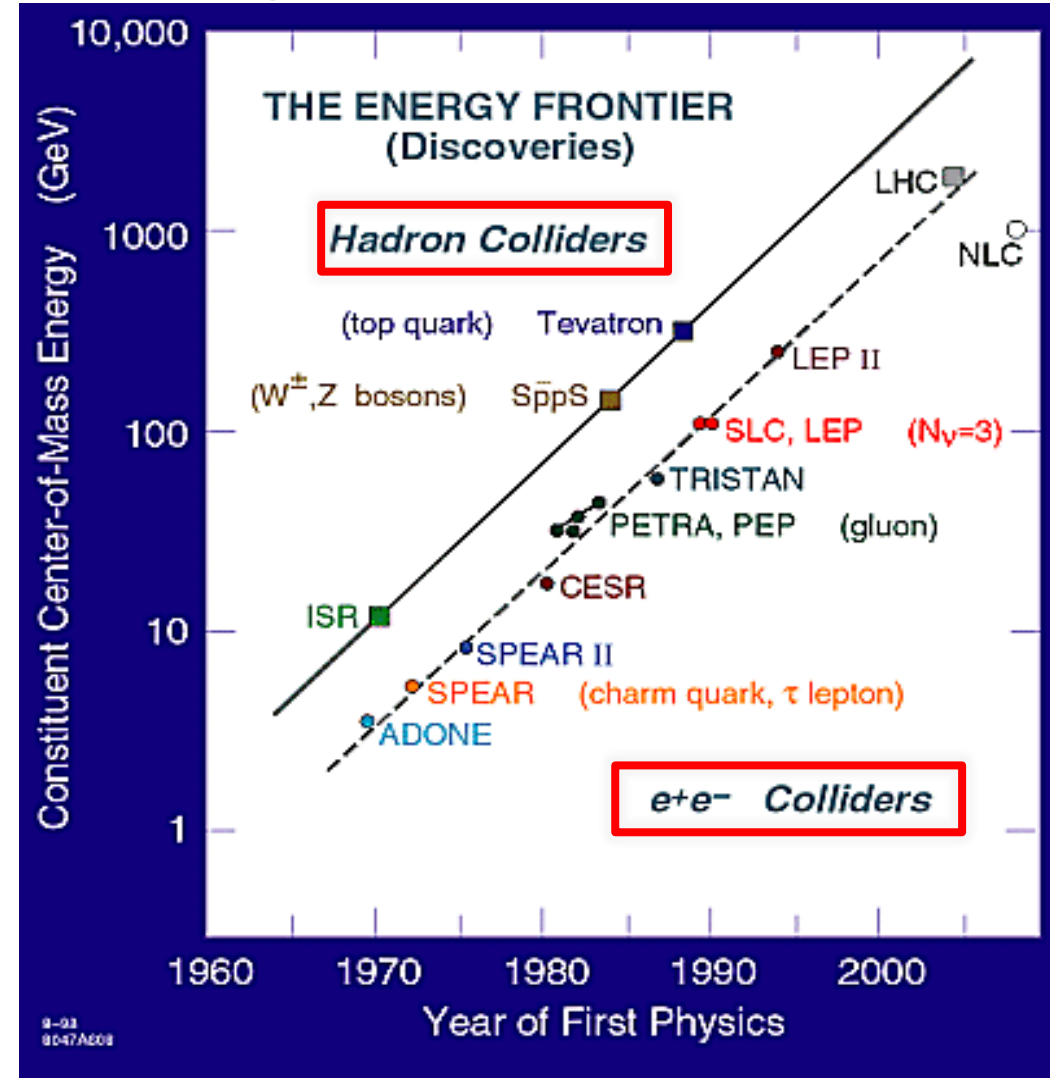
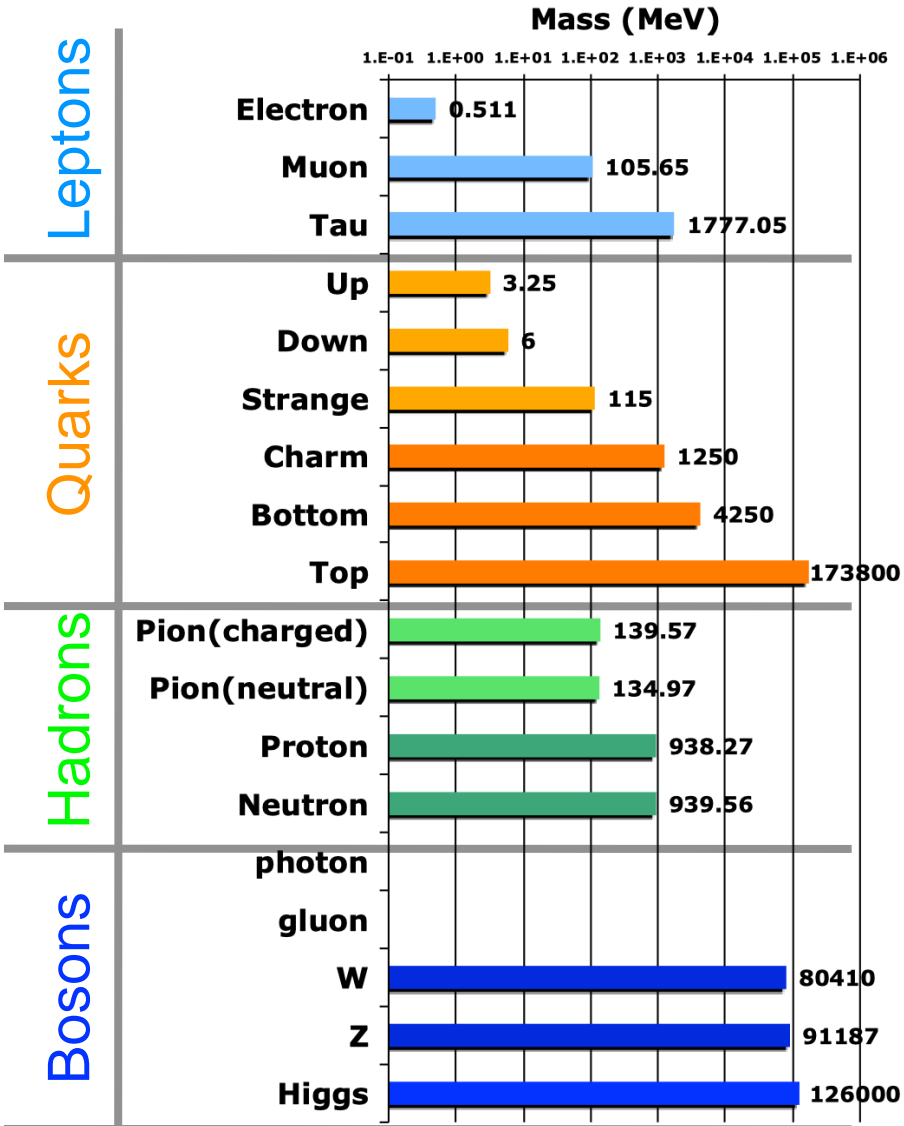

Different particle species used in the different collider: Why?

The right particle for the right scope

Electrons (and positrons) are (so far) point like particles: no internal structure

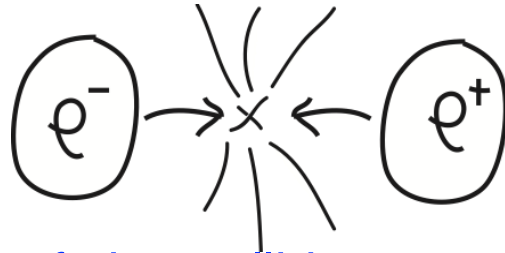

The energy of the collider, namely two times the energy of the beam colliding is totally transferred into the collision

$$E_{\text{coll}} = E_{b1} + E_{b2} = 2E_b = 200 \text{ GeV (LEP)}$$

Pros: the energy can be precisely tuned to scan for example, a mass region.

Precision measurement (LEP)

Cons: above a certain energy is no more possible to use electrons because of too high synchrotron radiation

Protons (and antiprotons) are formed by quarks (uud) kept together by gluons

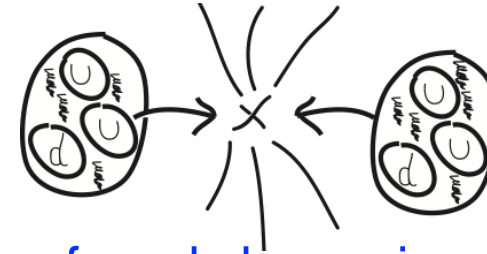

The energy of each beam is carried by the proton constituents, and it is not the entire proton which collides, but one of his constituent

$$E_{\text{coll}} \text{ (about 2 TeV at LHC)} < 2 E_b \text{ (14 TeV)}$$

Pros: with a single energy possible to scan different processes at different energies.

Discovery machine (LHC)

Cons: the energy available for the collision is lower than the accelerator energy

What is the LHC ? H = HADRON

- ▶ Protons are hadrons because are made of quarks

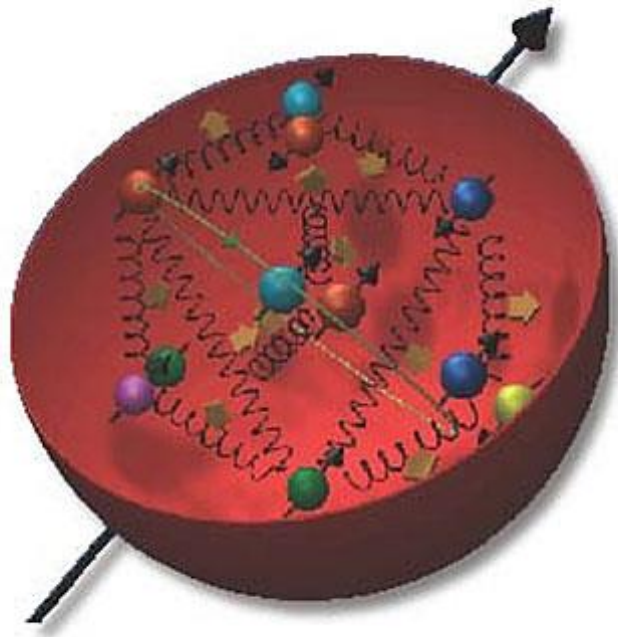

How many quarks in a proton?

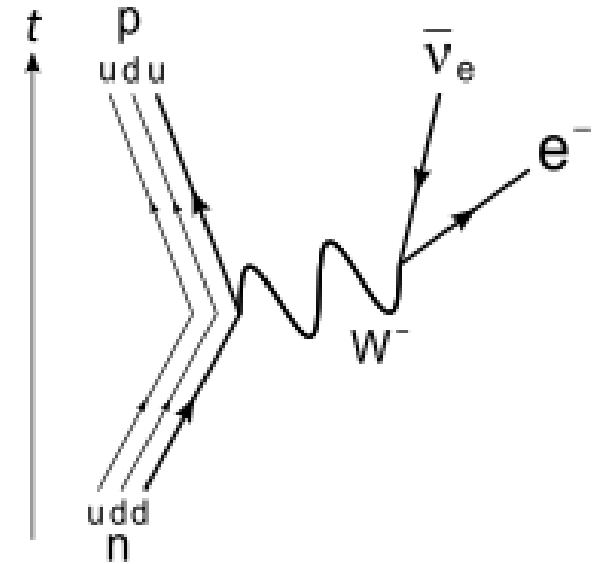
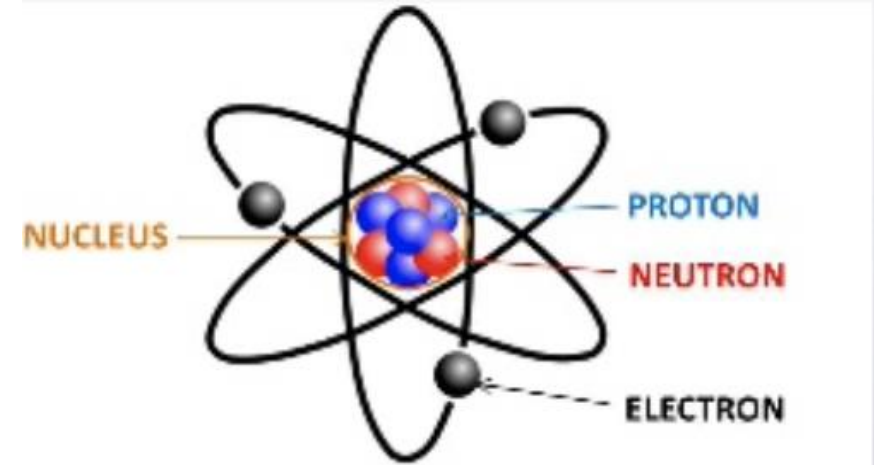

Different approaches: fixed target vs collider

Fixed target

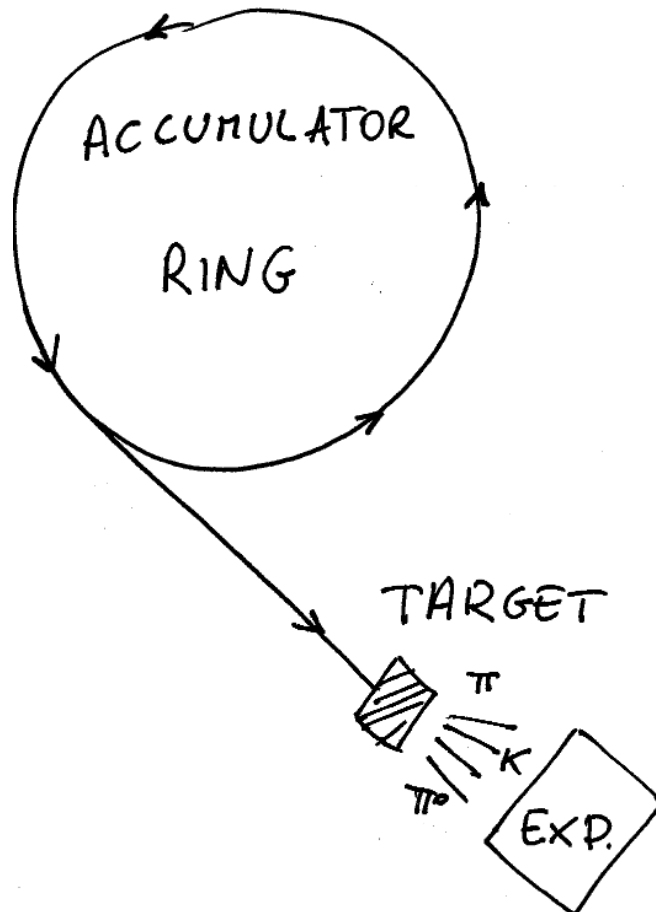

$$E_{CM} = \sqrt{2(E_{beam}mc^2 + m^2c^4)}$$

Storage ring/collider

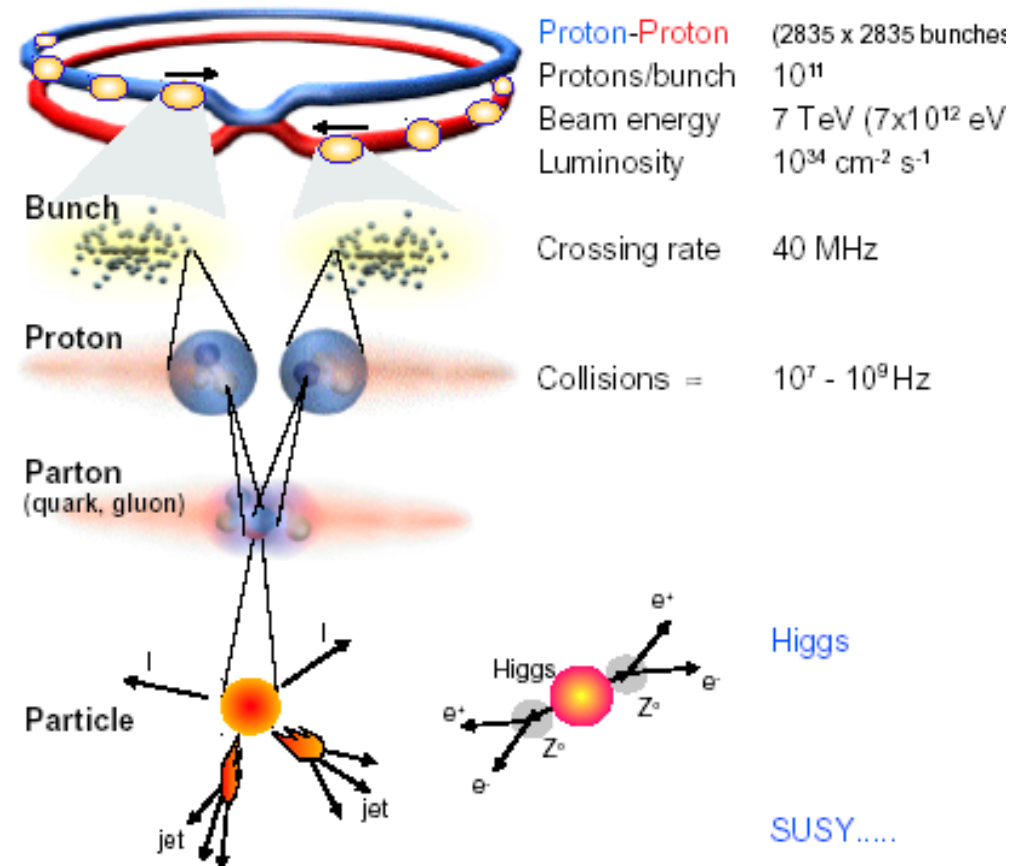

<<

$$E_{CM} = 2(E_{beam} + mc^2)$$

This usually is defined as \sqrt{s}

CNGS, conventional man-made neutrino beam

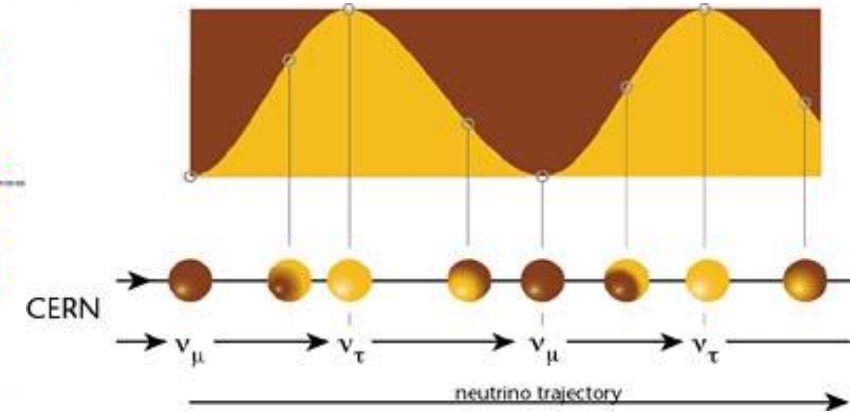
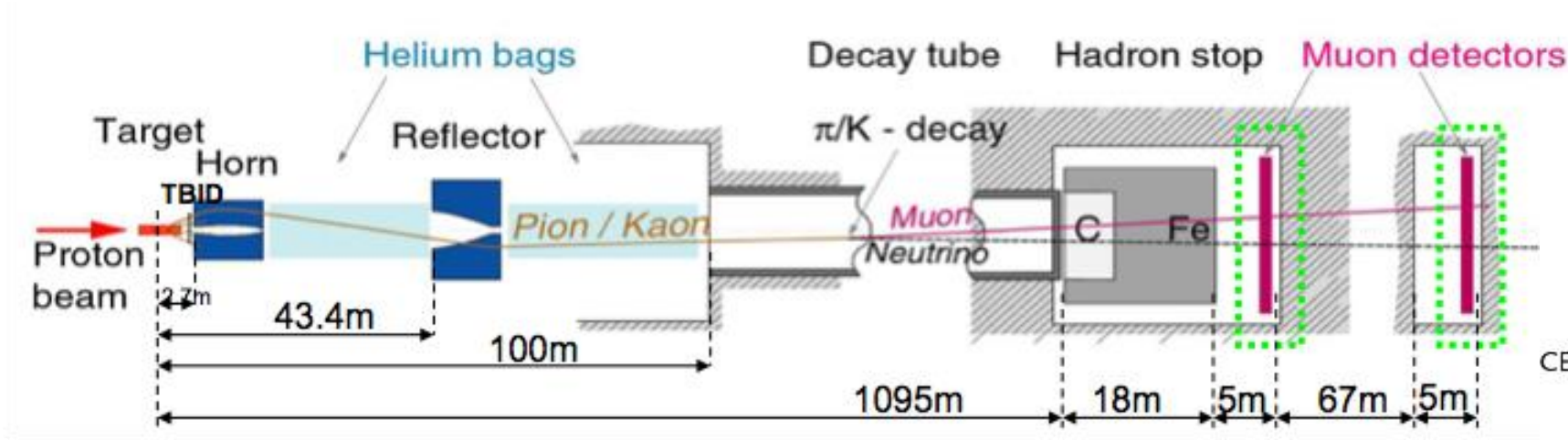

CERN to Gran Sasso

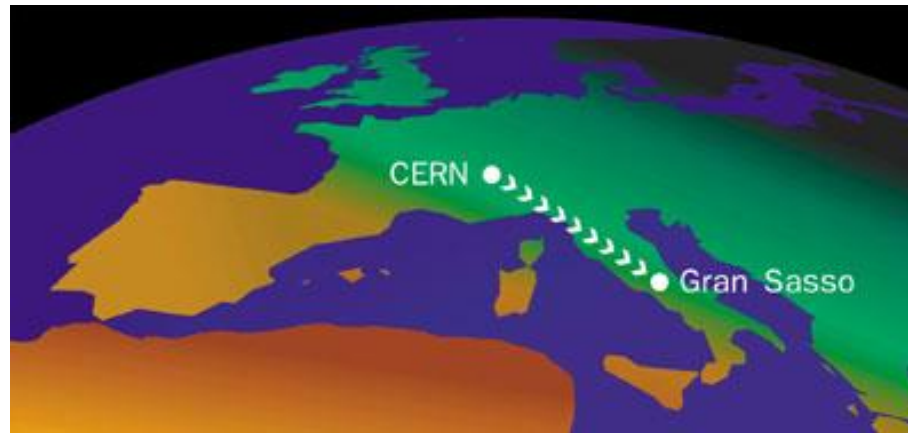
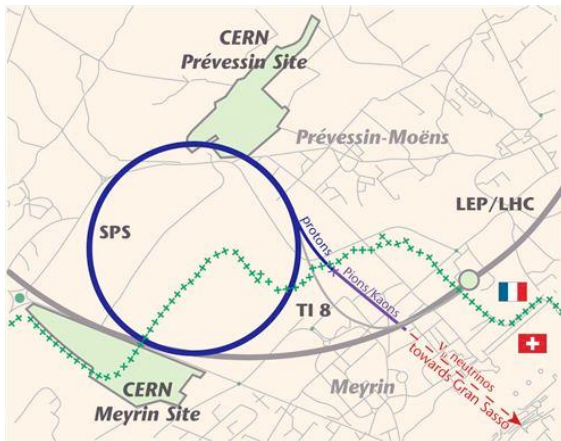

CNGS looked for ν_τ appearance in a beam of ν_μ

The beam was sent from the SPS at 400 GeV/c on the C target. It was “only” a 450 kW beam

Accelerators for cancer therapy

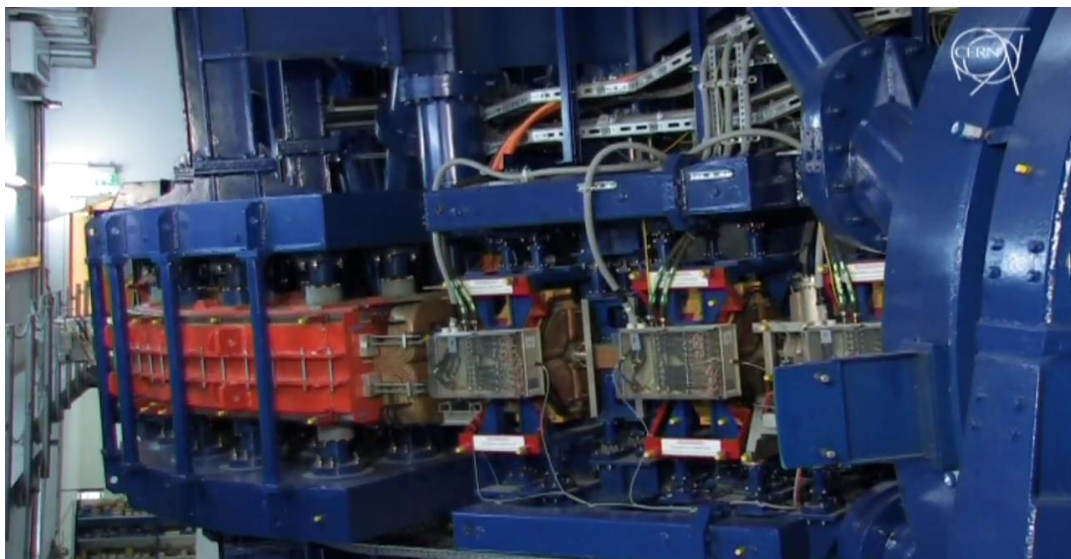

THE HEIDELBERG ION THERAPY (HIT)

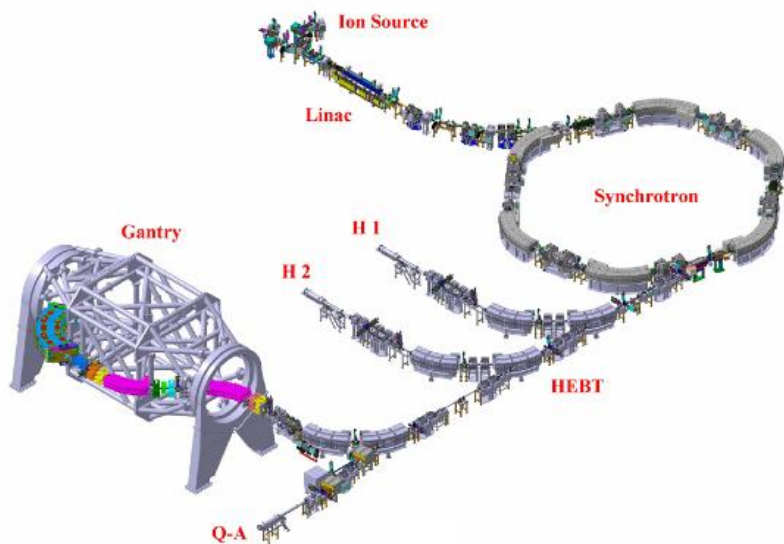

Cyclotron application: cancer therapy, photons vs protons

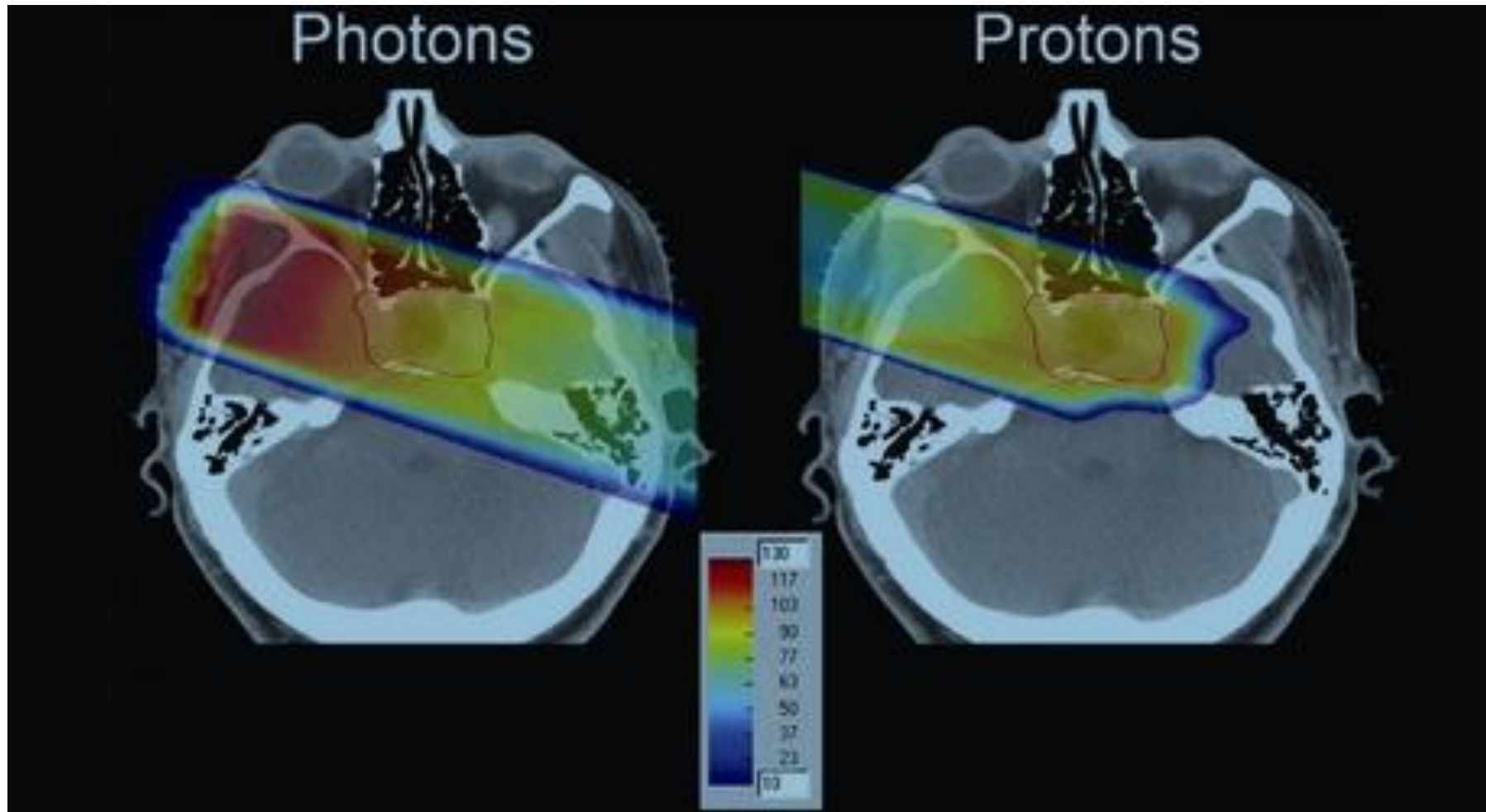

<https://kce.fgov.be/publication/report/hadron-therapy-in-children---an-update-of-the-scientific-evidence-for-15-paediatr#.VehXyluNeDs>

Different approaches: fixed target vs collider

Fixed target

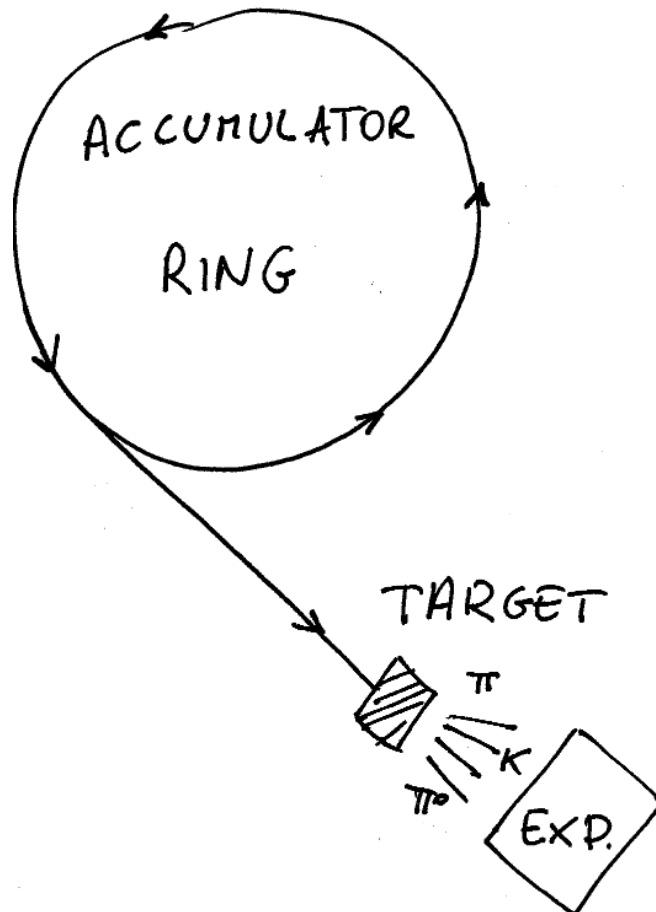

$$E_{CM} = \sqrt{2(E_{beam}mc^2 + m^2c^4)}$$

Storage ring/collider

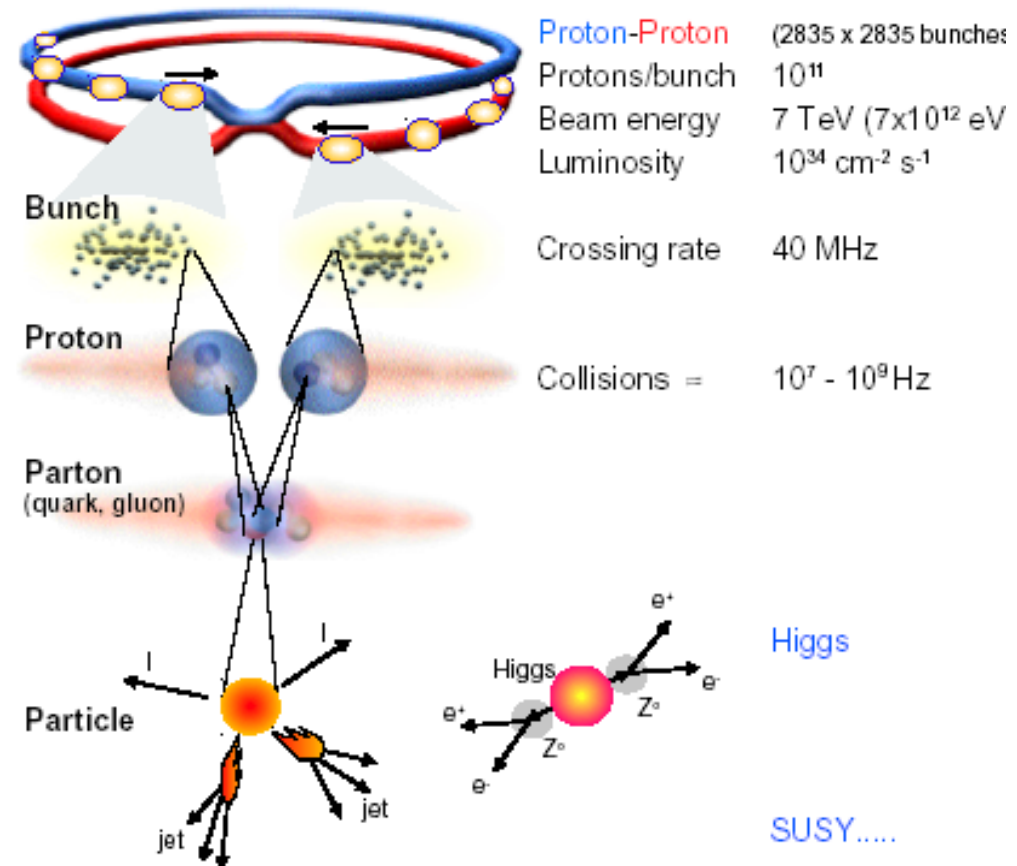

<<

$$E_{CM} = 2(E_{beam} + mc^2)$$

This usually is defined as \sqrt{s}

Collider: LHC with 4 collision points (IP)

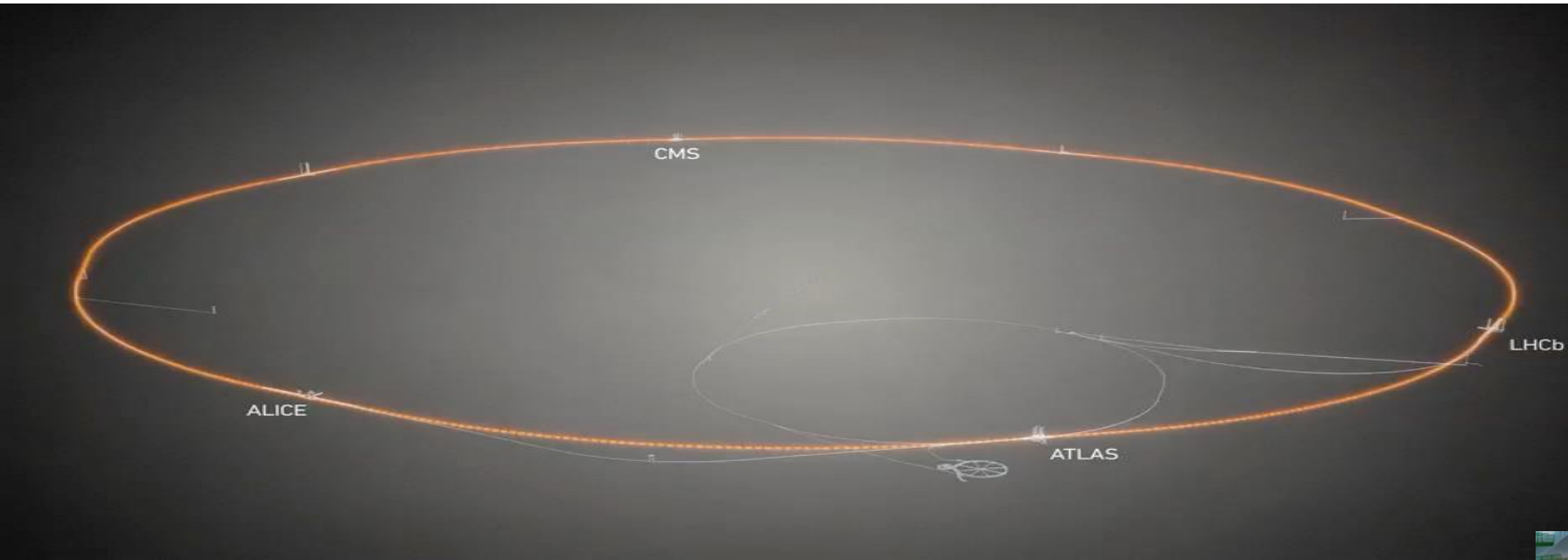

CMS/TOTEM

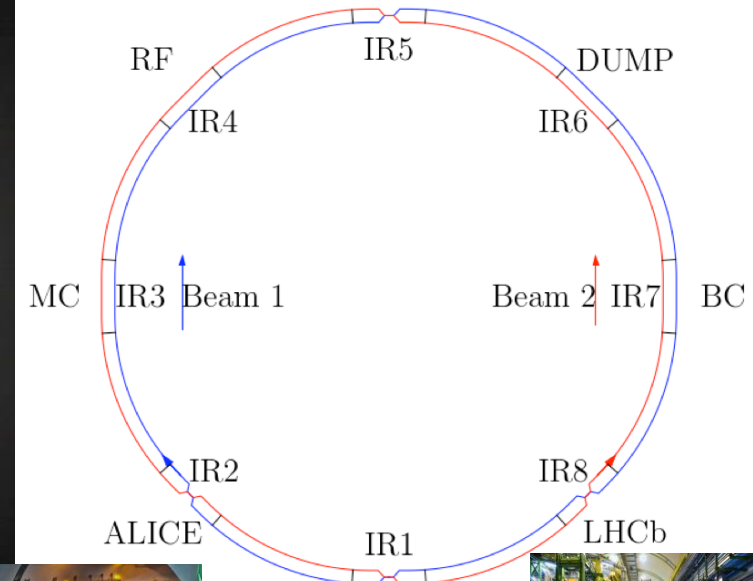

ATLAS/LHCb



4 main experiments → Alice, ATLAS, CMS, LHCb

Where the beam size is reduced to a minimum → important for later on...

The Large Hadron Collider : the LHC

The largest machine and scientific instrument ever built by mankind

.... For the moment....

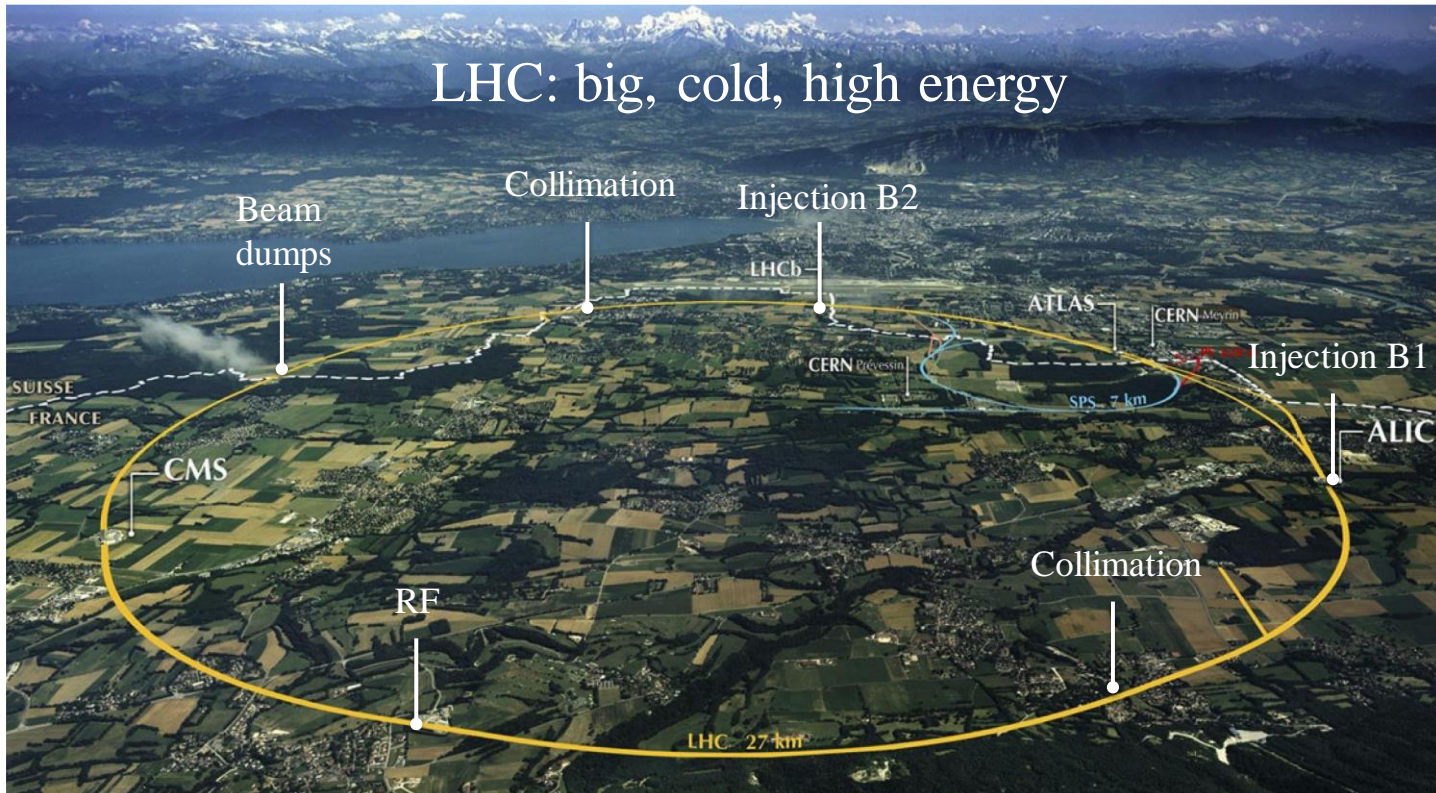

Quantity	Number
Circumference	26 659 m
Dipole operating temperature	1.9 K (-271.3°C)
Number of magnets	9593
Number of main dipoles	1232
Number of main quadrupoles	392
Nominal energy, protons	6.5 TeV (6.8 TeV)
Nominal energy, protons collisions	13 TeV (13.6 TeV)
No. of protons	Some 10^{14}
Number of turns per second	11245
Number of collisions per second	1 billion

Why the LHC is so complicated?

One has to control **~2000 needles travelling at the speed of light** with the **energy sufficient to melt 2.5 tons of copper** in such a way that they meet each and every single second about **11000 times**.

While leaving at a temperature which is cooler than the empty space and 100 m underground.

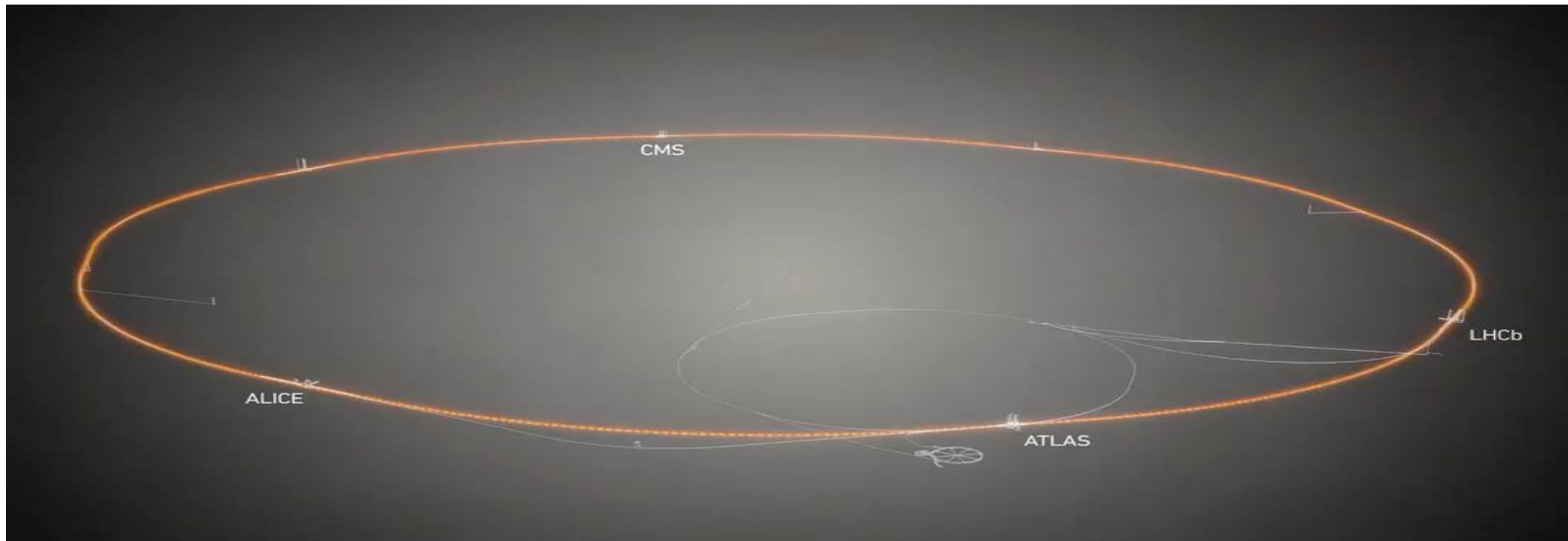

A collider event

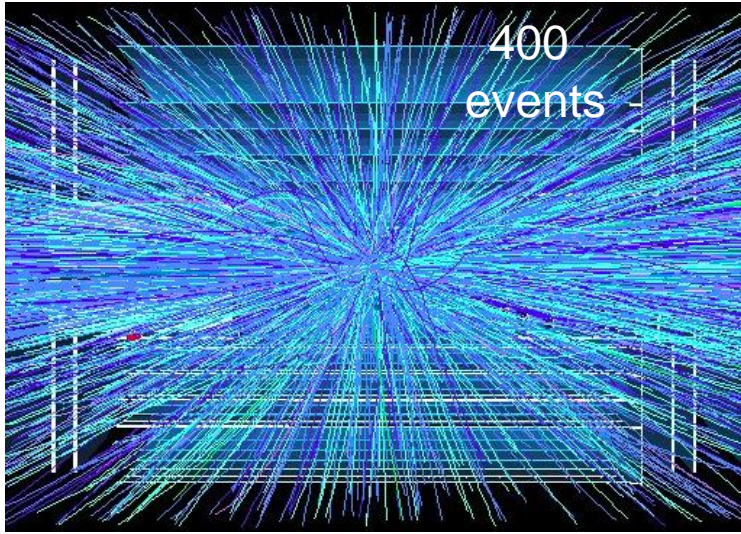
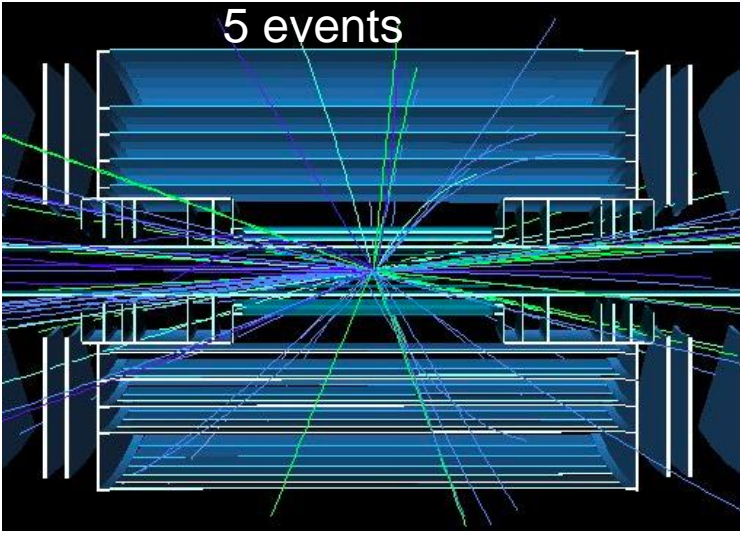
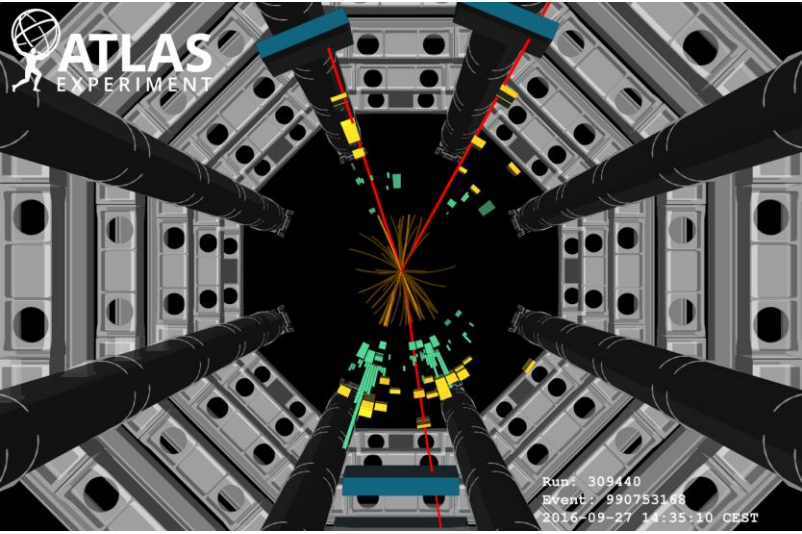

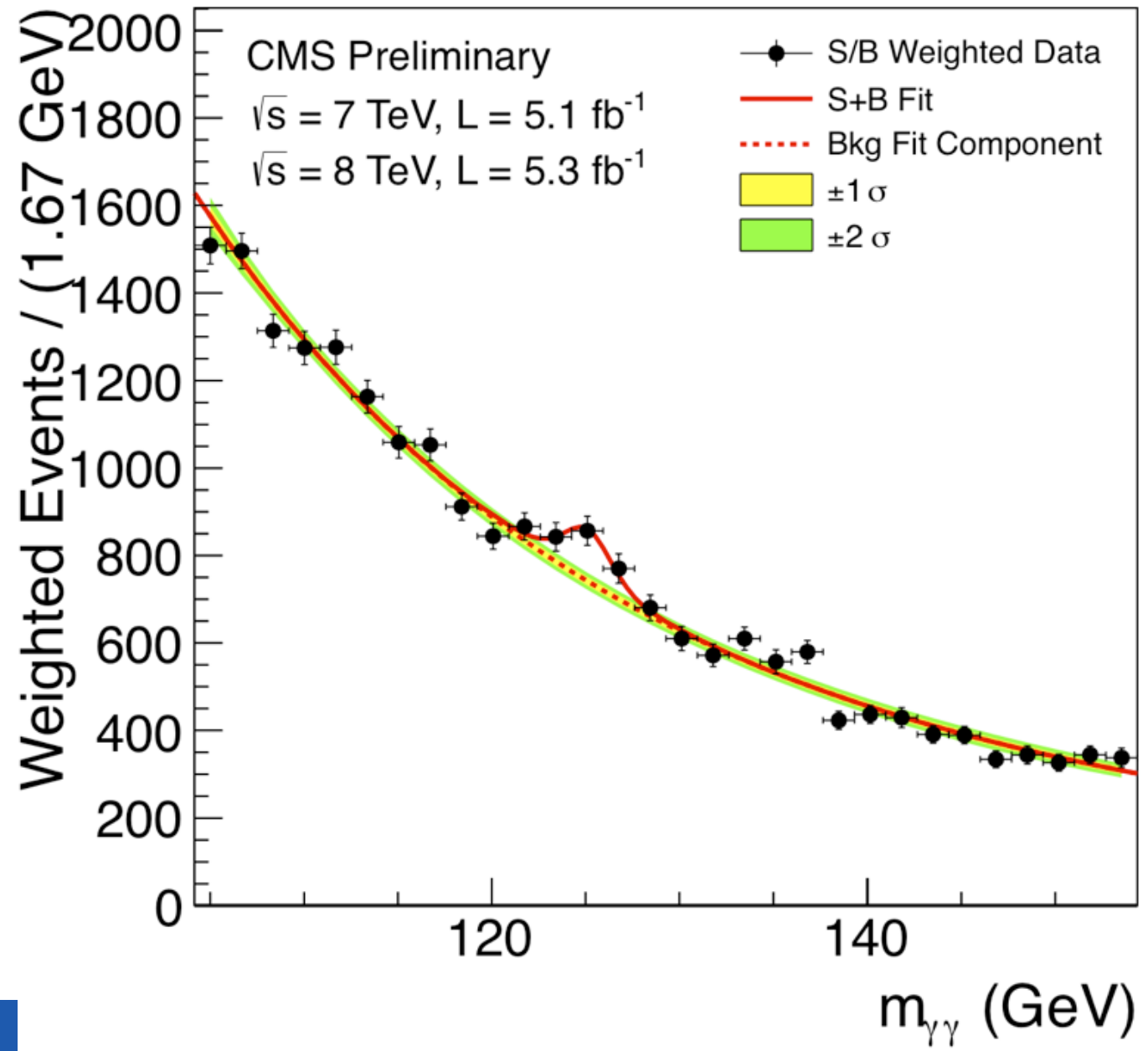

SPEECH DELIVERED BY PROFESSOR NIELS BOHR
ON THE OCCASION OF THE INAUGURATION OF THE CERN PROTON SYNCHROTRON

ON 5 FEBRUARY, 1960

Press Release PR/56
12 February, 1960

It may perhaps seem odd that apparatus as big and as complex as our gigantic proton synchrotron is needed for the investigation of the smallest objects we know about. However, just as the wave features of light propagation make huge telescopes necessary for the measurement of small angles between rays from distant stars, so the very character of the laws governing the properties of the many new elementary particles which have been discovered in recent years, and especially their transmutations in violent collisions, can only be studied by using atomic particles accelerated to immense energies. Actually we are here confronted with most challenging problems at the border of physical knowledge, the exploration of which promises to give us a deeper understanding of the laws responsible for the very existence and stability of matter.

All the ingredients are there: we need **high energy** particles produced by **large accelerators** to study the **matter constituents** and their **interactions laws**. This also true for the LHC.

Small detail... Bohr was not completely right, the “**new**” **elementary particles** are not elementary but mesons, namely formed by quarks

What is the LHC ? L = LARGE → 27 km

Large: high energy needs large bending radius due to the maximum magnetic field existing technology can produce 26.7 km circumference

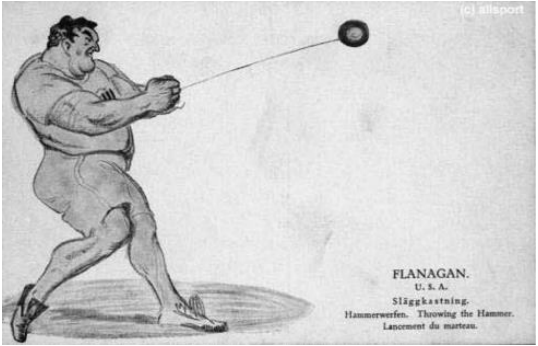

Something related to the force to keep particles on track

Magnetic Field
Limited by technology

$$k = \frac{1}{\rho} = \frac{e}{p} B = \frac{e\mu_0 nI}{p h}$$

Radius: limited by cost, and by the radius of the Earth...

Energy : given by the physics
This will depend on the mass of the particles we want to discover

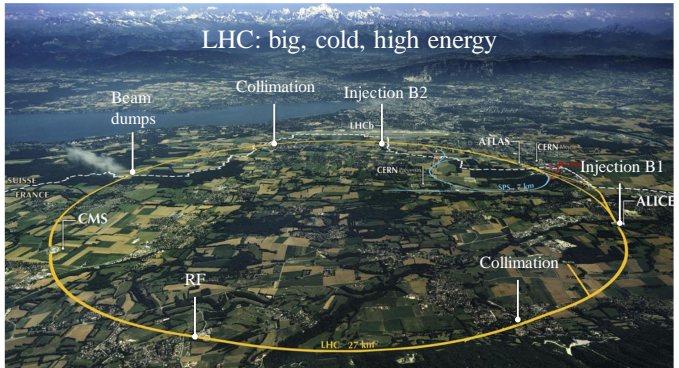
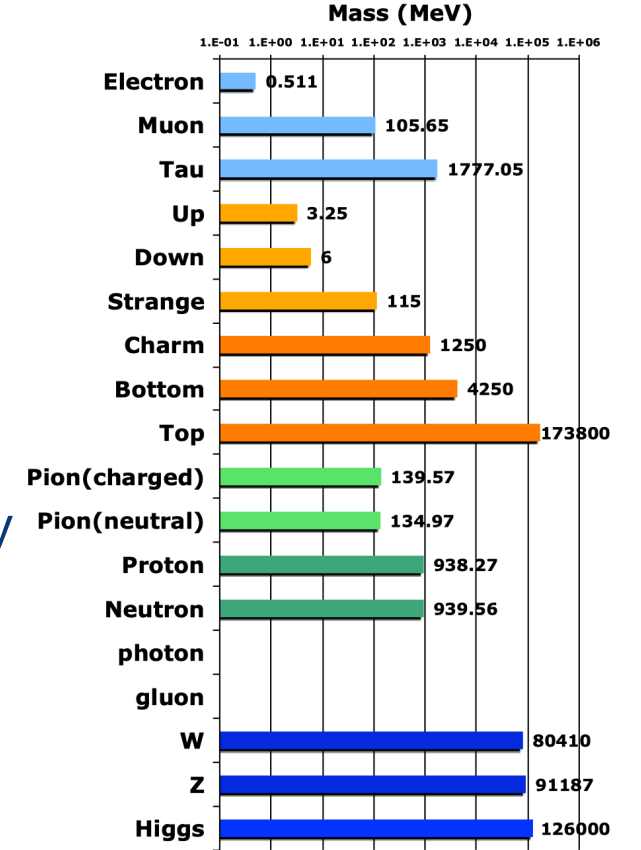

What's next: LARGE?

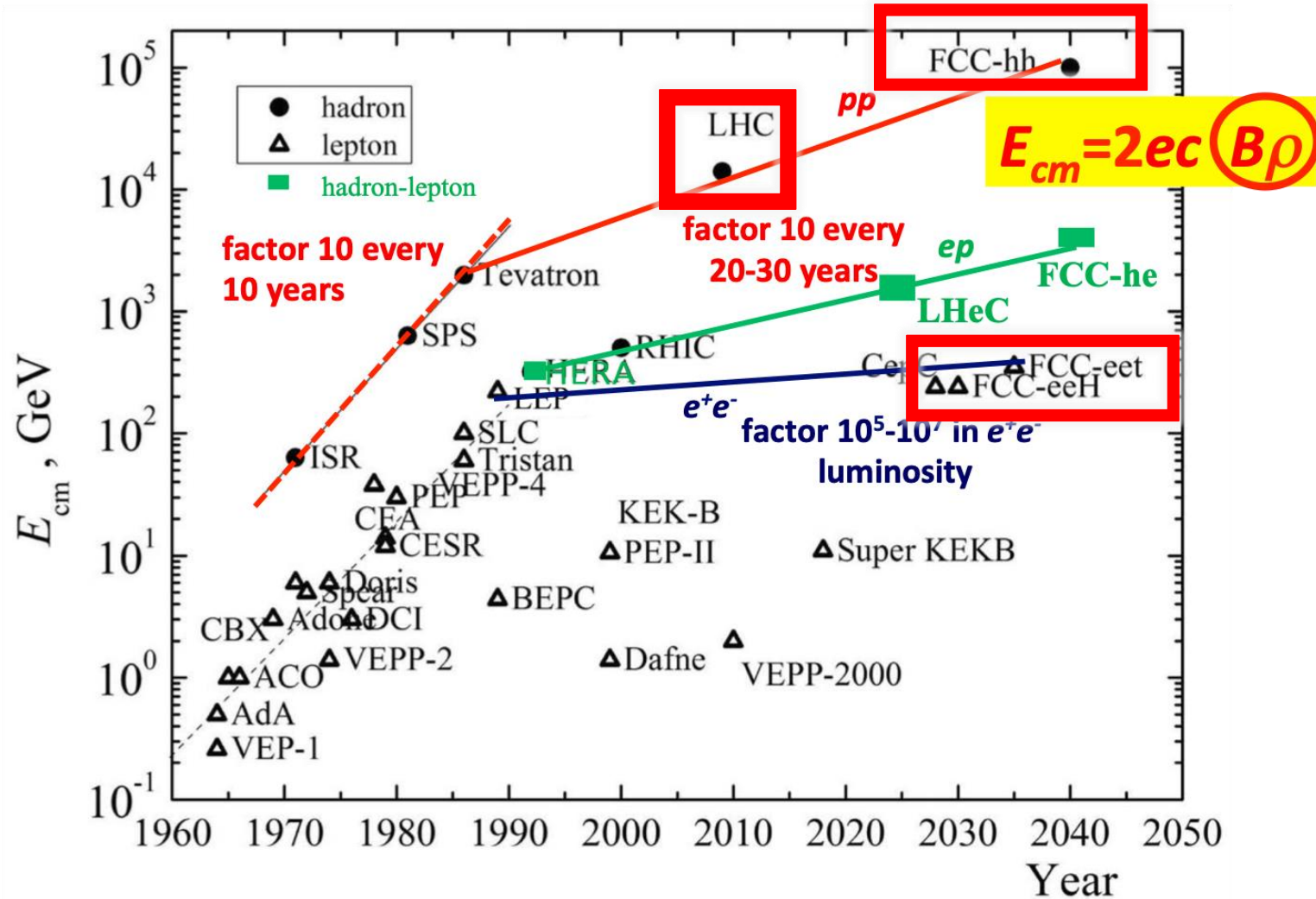

$$k = \frac{1}{\rho} = \frac{e}{p} B$$

Courtesy V. Shiltsev

What's the future ? Going bigger

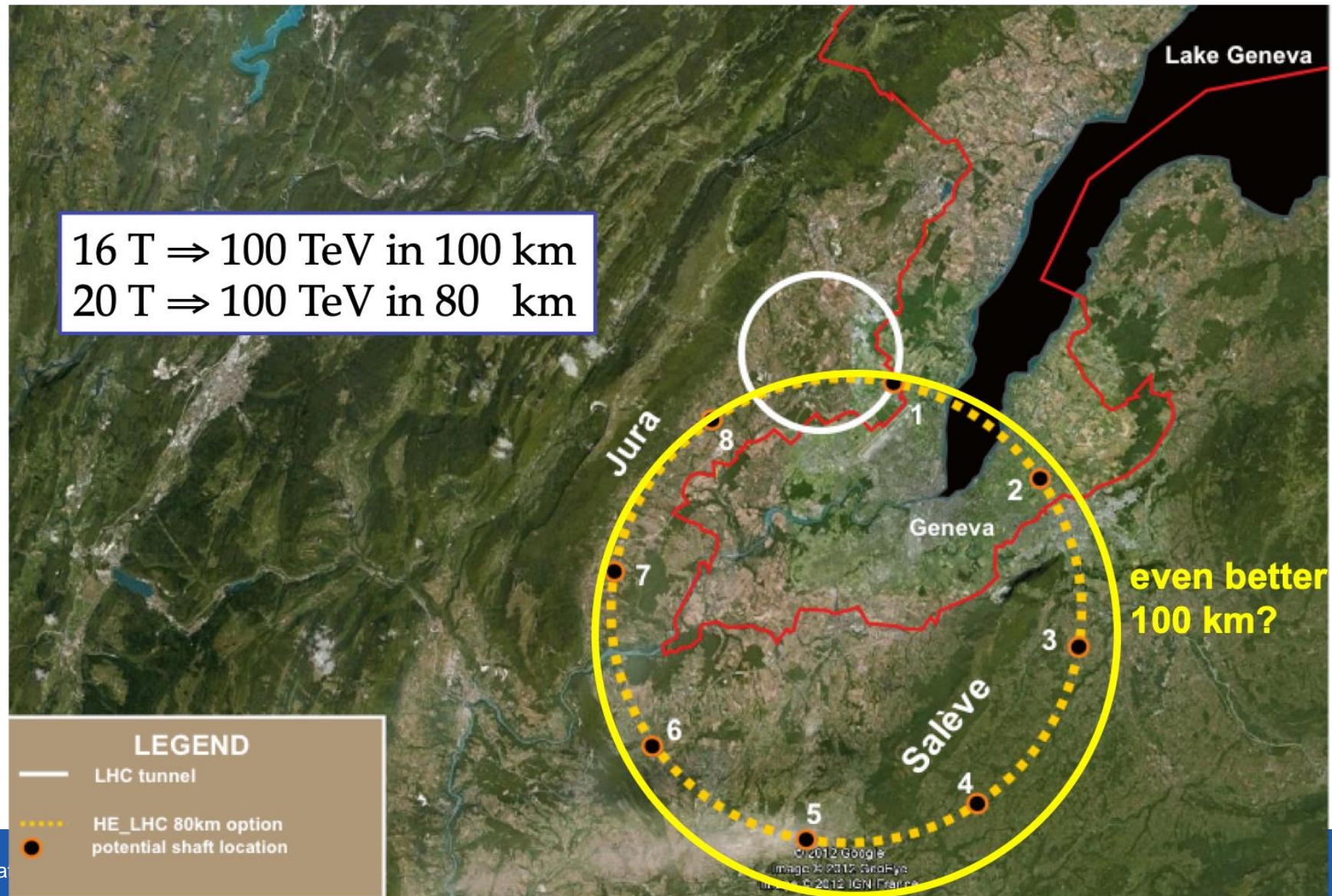

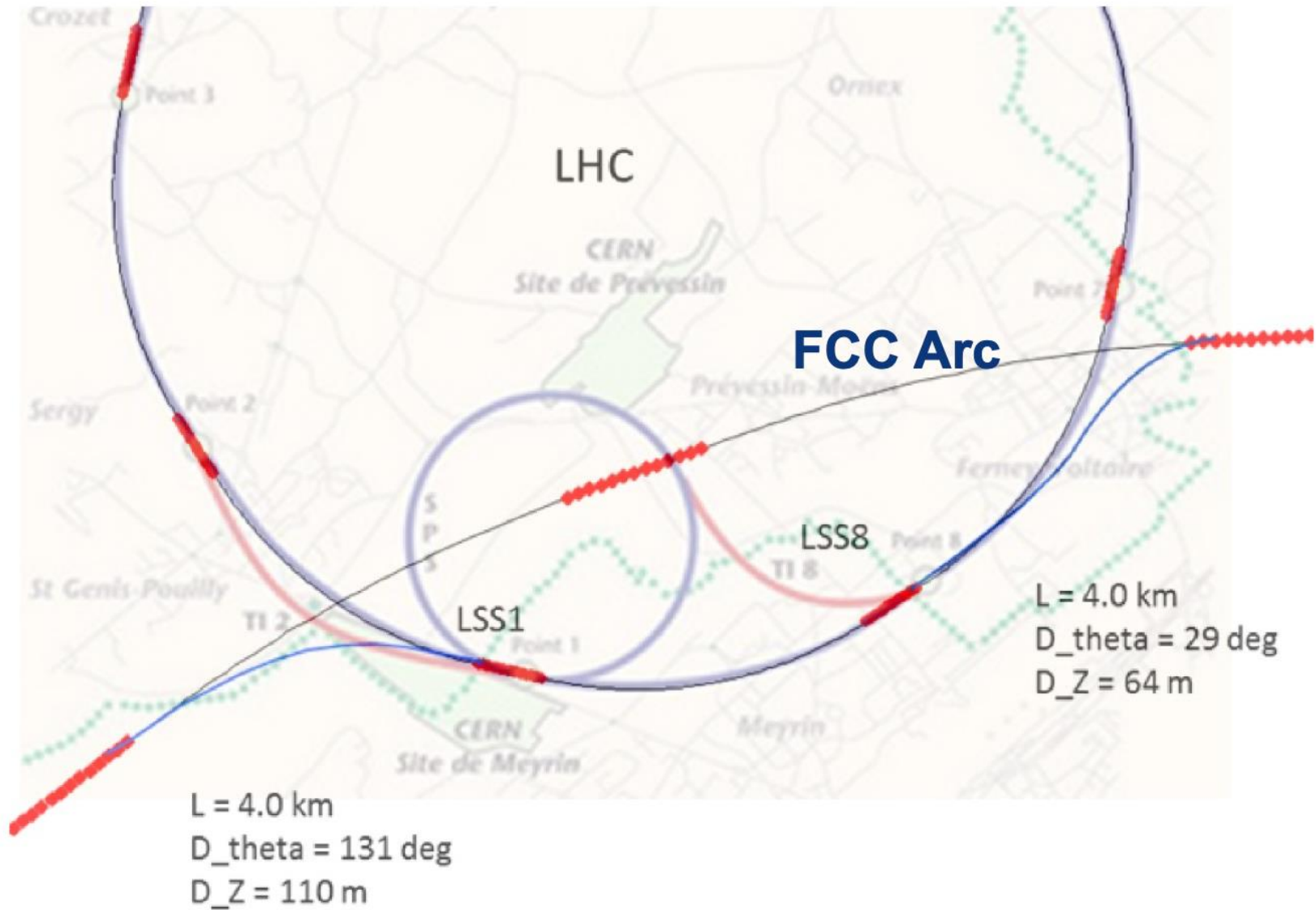

FUTURE CIRCULAR COLLIDER (FCC) - 3D Schematic

Underground Infrastructure - Single Tunnel Design

John Osborne - Charlie Cook - Ángel Navascués

- █ FCC Tunnels
- █ Experimental points
- █ Access points
- █ Service caverns
- █ Connection tunnels
- █ LHC

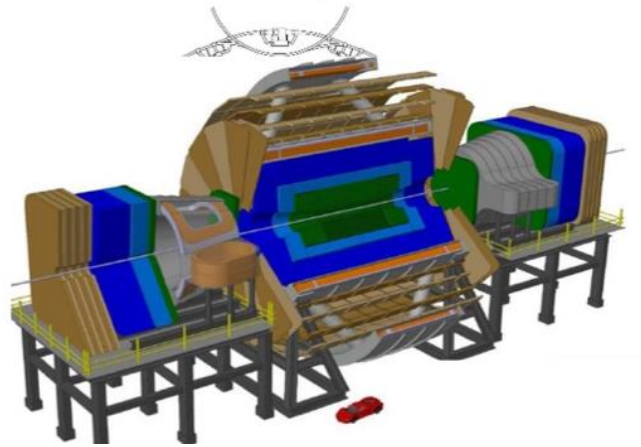
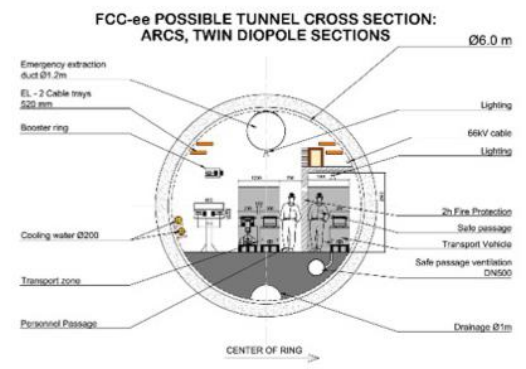
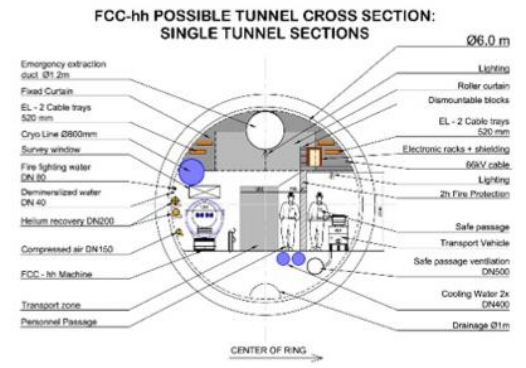
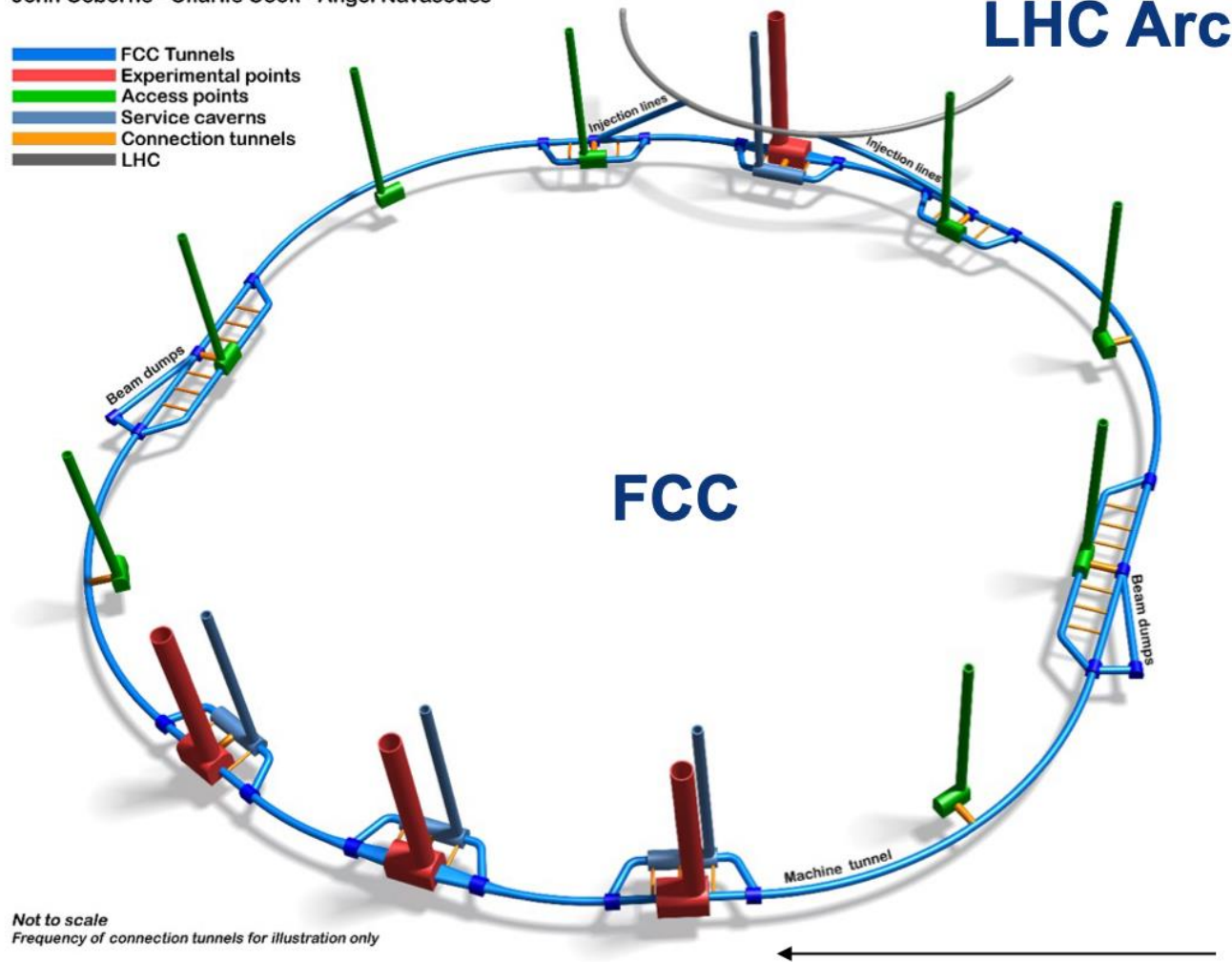

FCC landscape (with options)

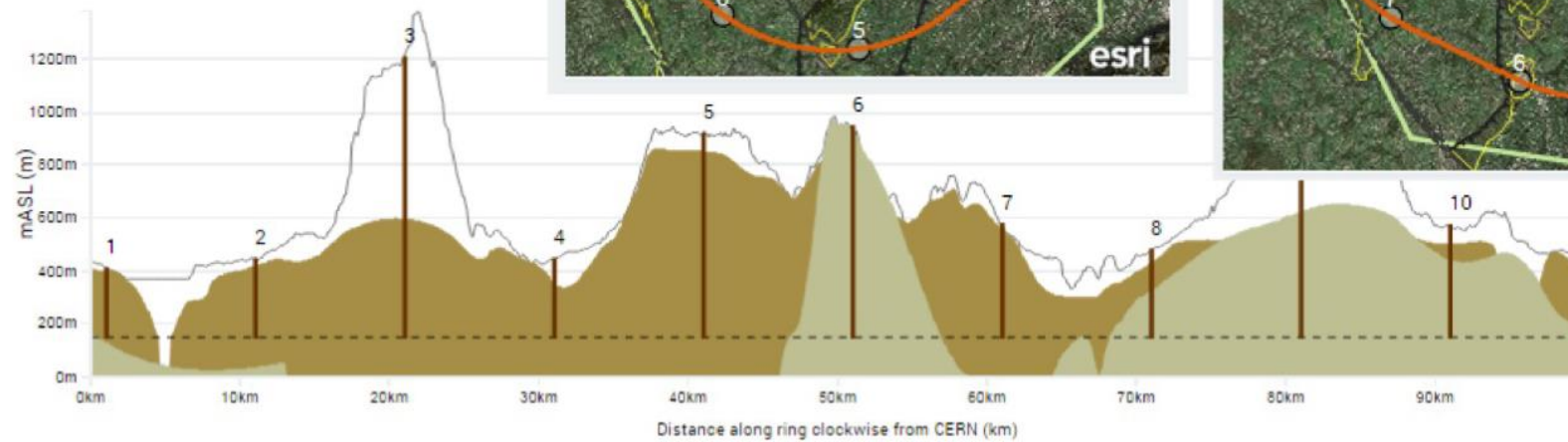
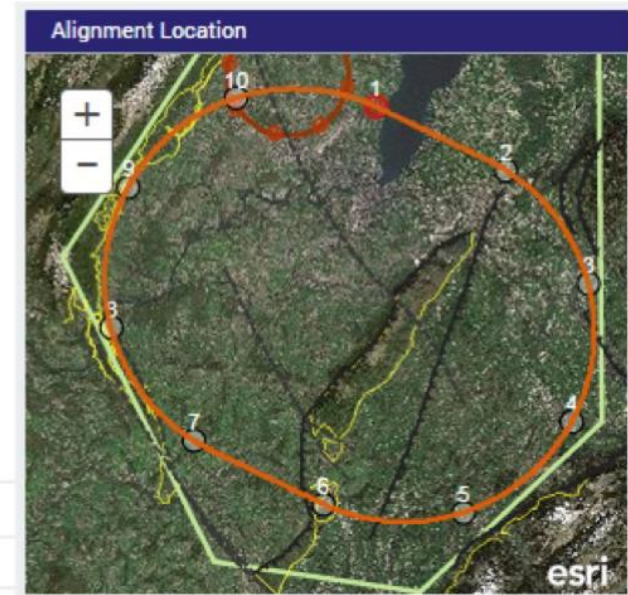
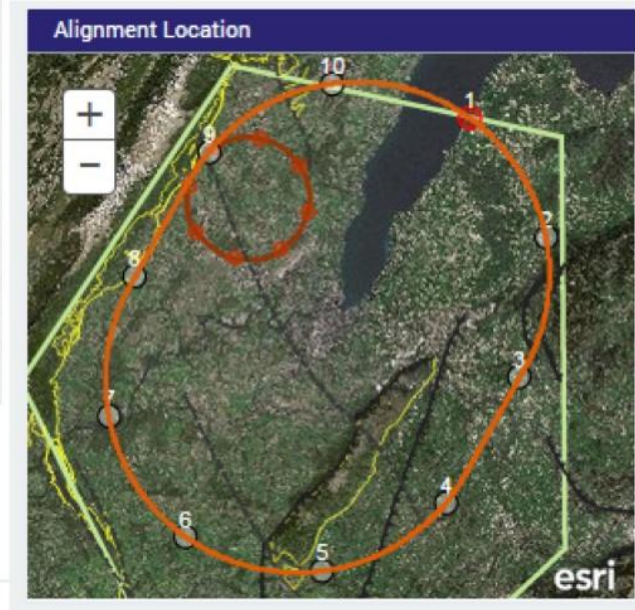
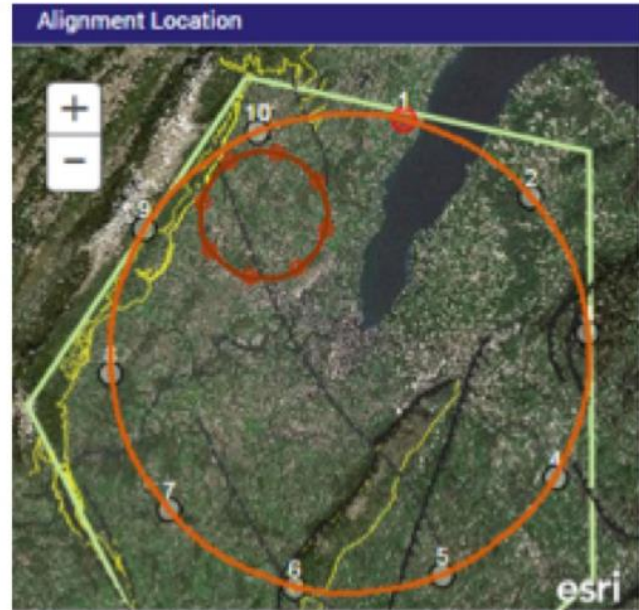

CERN Circular Colliders : FCC

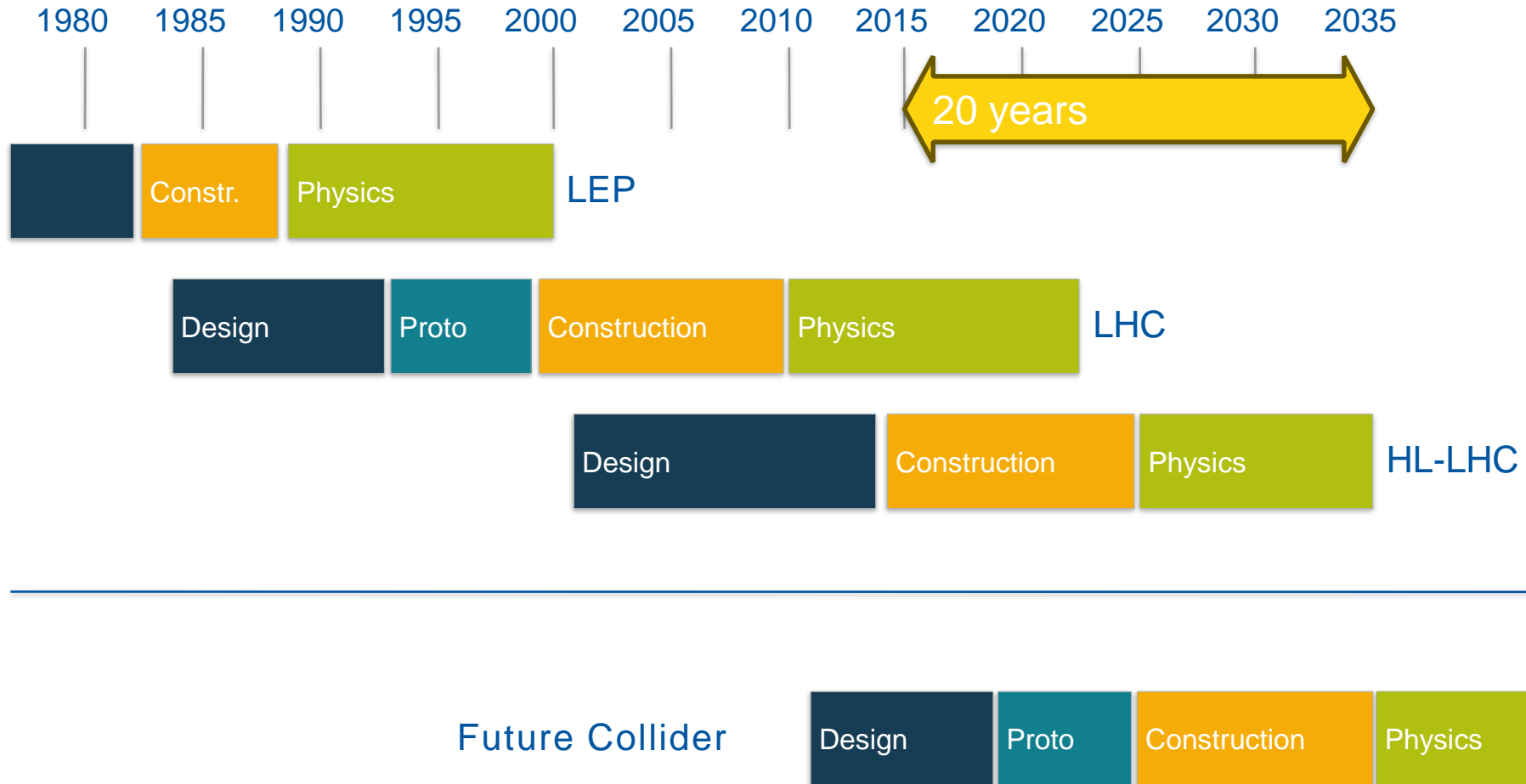

An alternative: the muon collider

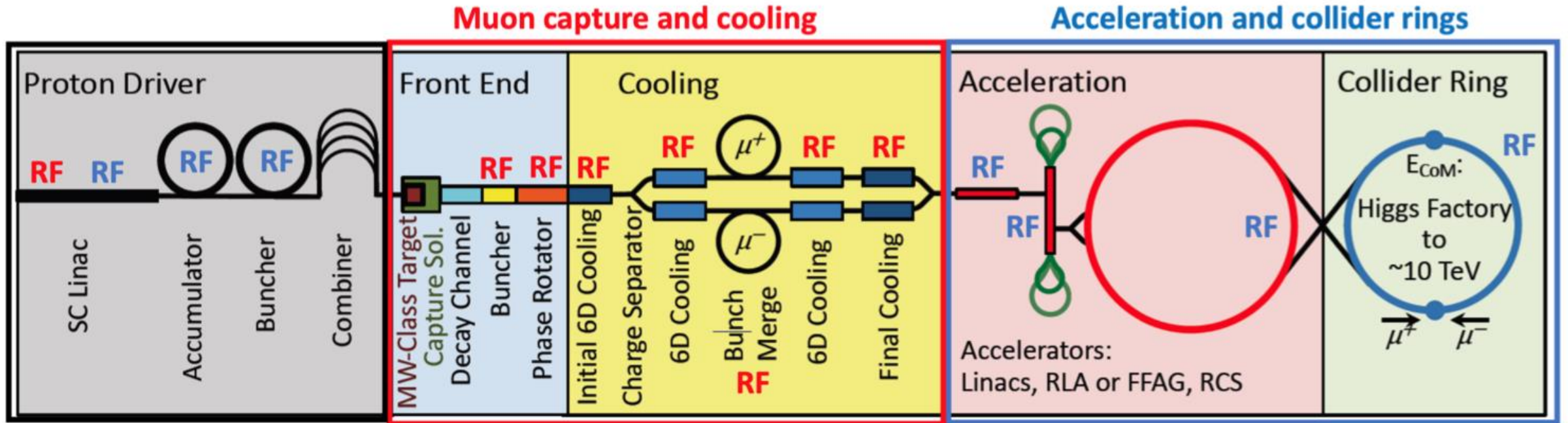

Are muons stable particles?

Courtesy of A. Grudiev et al.

Muon collider proposal at Fermilab (US)

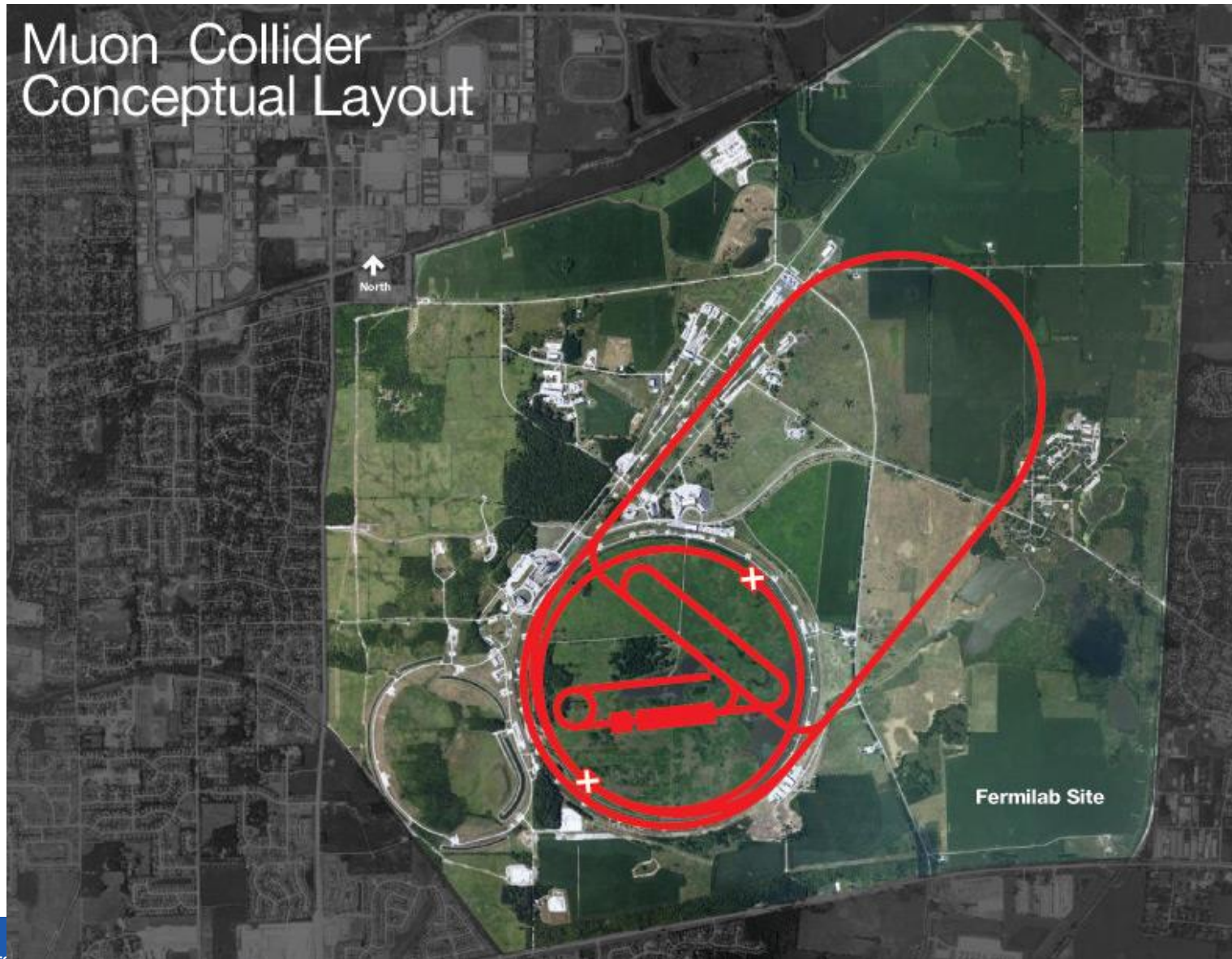

... or back to the future

5000 TeV

B=2 T

R = 8000 km

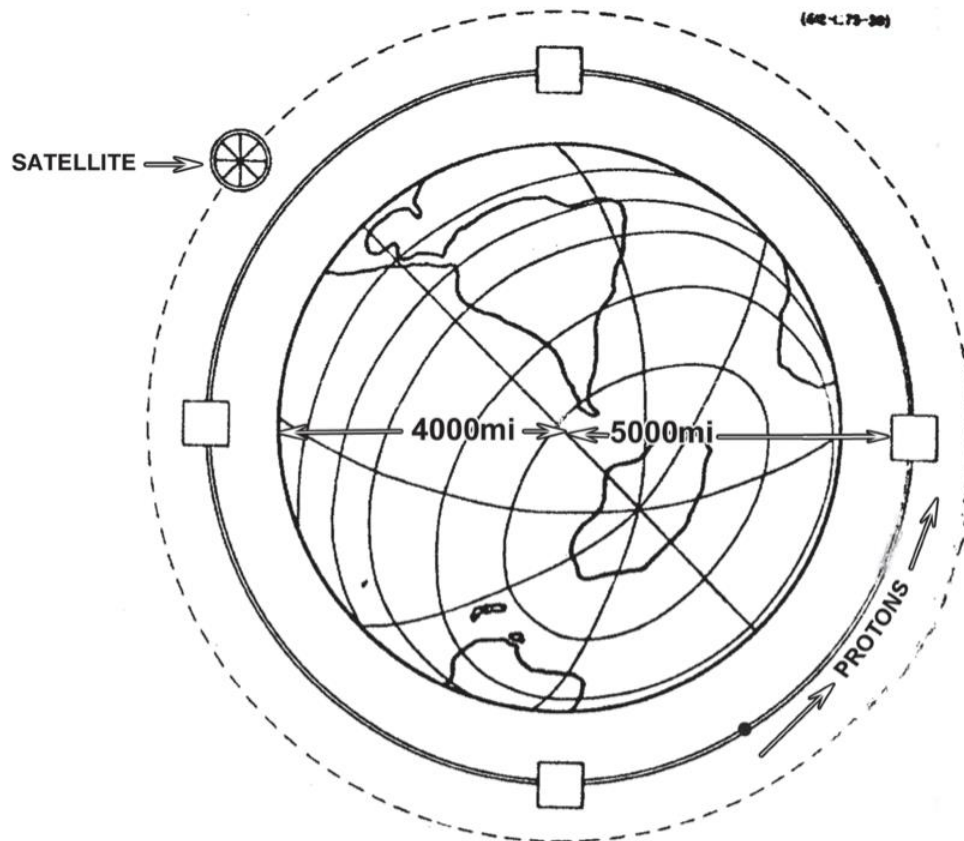

By E. Fermi

“Preliminary design...8000 km, 20.000 gauss” for 1994

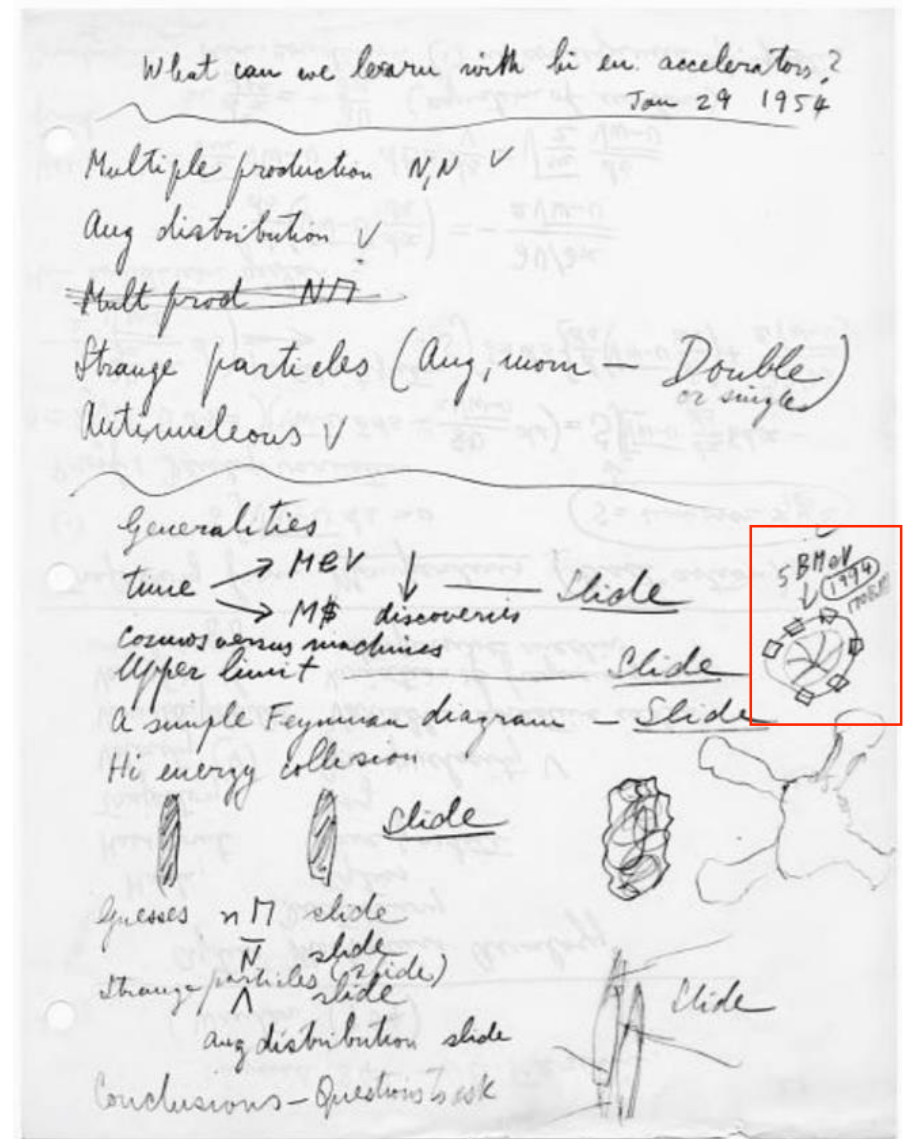

Images courtesy of the Special Collections Research Center, University of Chicago Library and Cronin J (ed.) Fermi Remembered (University of Chicago Press, 2004)

Ultimate physical limits?

Where is the limit?

- Maximum voltage gradient: limited by spontaneous e+e- pair production in vacuum to *Swinger critical field* of 10^{18} V/m
 - Assume a comfortable engineering margin: take 10^{17} V/m
- Linac length to reach Planck scale: $\sim 10^{11}$ m (per Linac)
- Earth-sun distance: 149'000'000 km = 1.5×10^{11} m
- So: Linear collider at scale of earth orbit, at 10% of vacuum critical field gradient
- Circular colliders are out: with 1'000 T bend field, takes a 10 light year diameter to reach 10^{28} eV. Beam revolution period is 31 years....

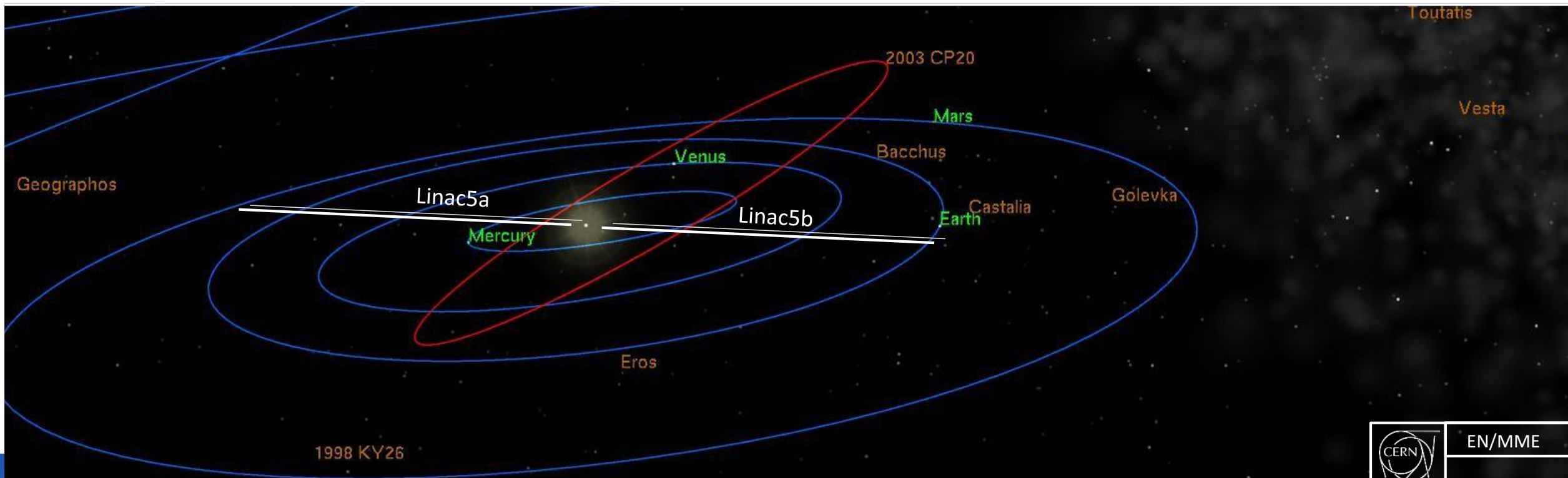

Beam loss control will be important: a single proton at $1e28$ eV = 1'600 MJ



EN/MME

Not for execution

A bit of hystory

The first electron-positron 250 MeV collider/storage ring, AdA (1960), built and operated at Frascati

AdA = Anello di Accumulazione

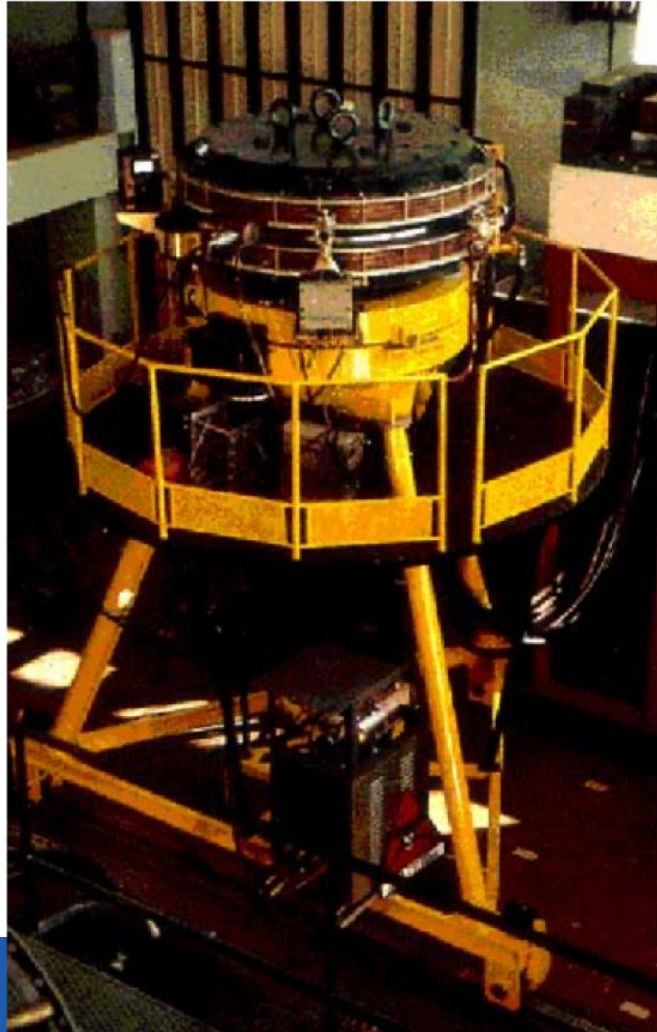

First collisions in 1963: not for producing HEP data but to bring better understanding of beam dynamics



The most recent CERN (de)celerator... ELENA

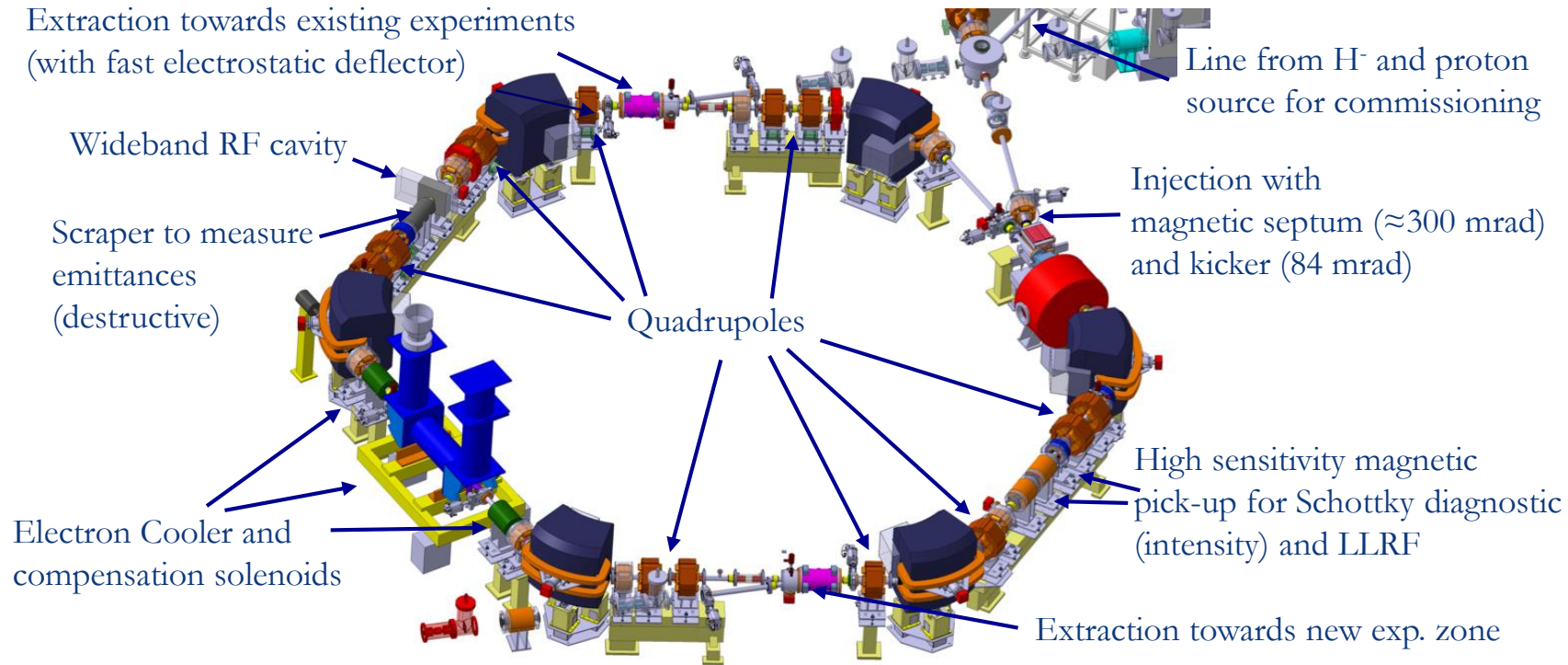

- Deceleration of antiprotons from 5.3 MeV to 100 keV to improve efficiency of antimatter experiments
- Circumference 30.4 m
 - Fits in available space in AD hall and allows installing all equipment without particular efforts
 - Lowest average field (beam rigidity over average radius) $B\rho/R = 94$ G (smaller than for AD 115 G)

ELENA in AD hall

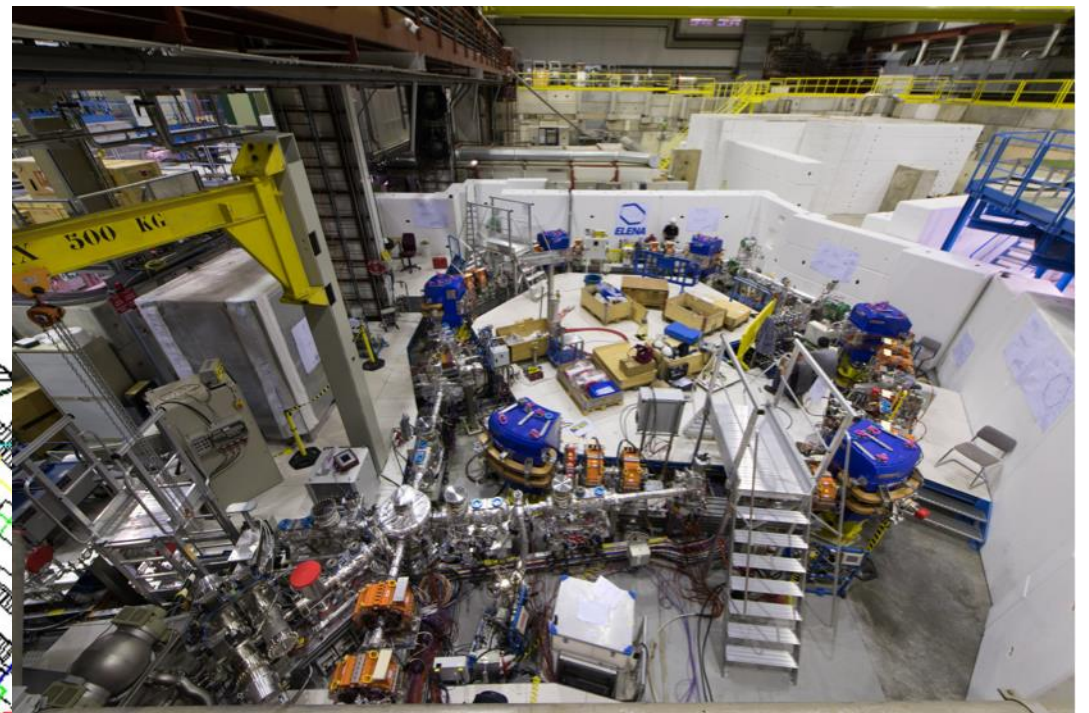
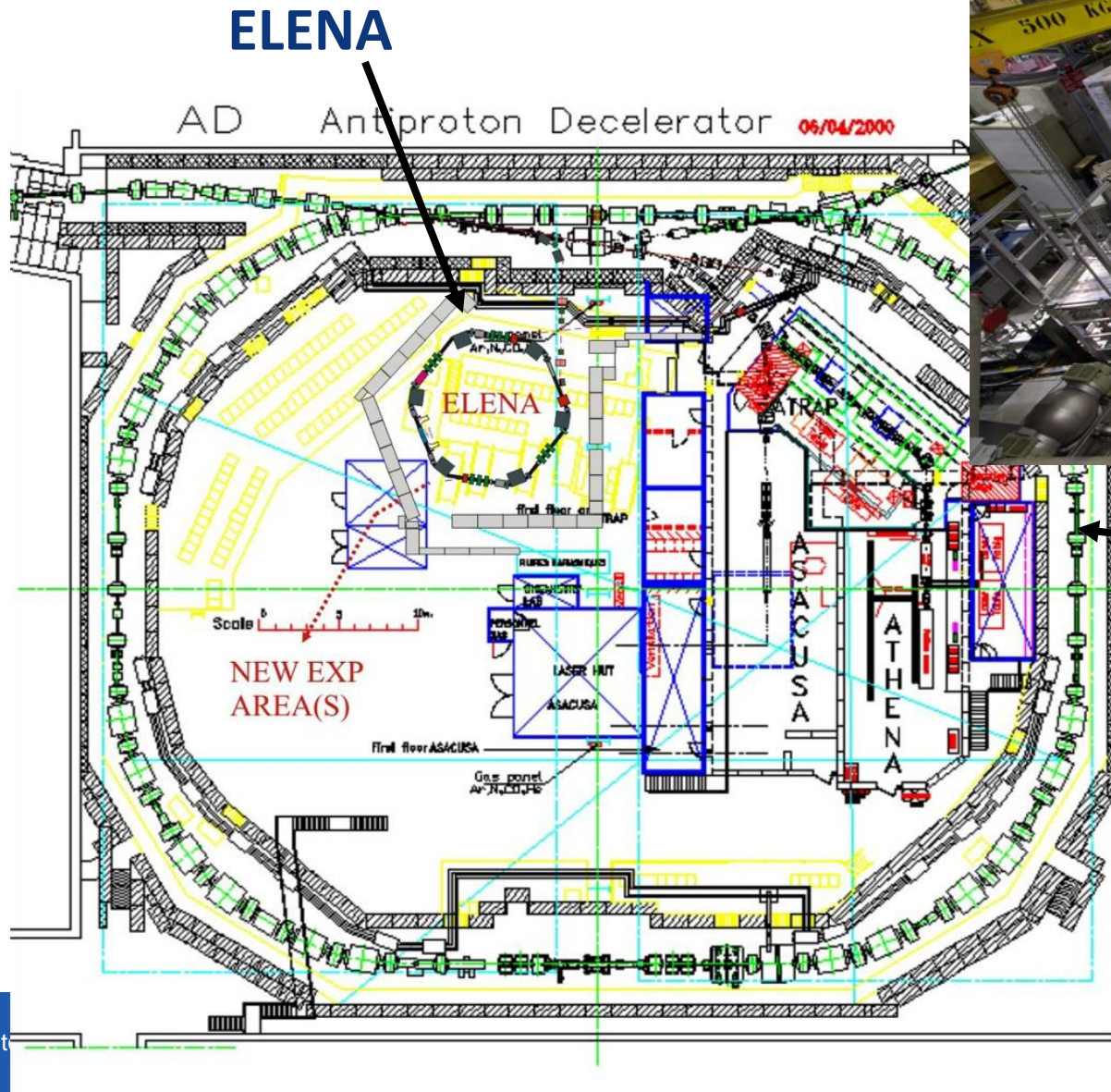

AD

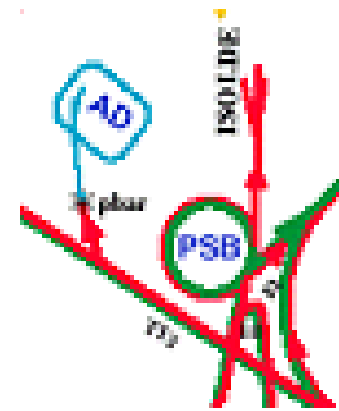

Influence of environmental magnetic fields

General tolerance for the background field 0.1 G i.e. $10 \mu\text{T}$ ($\sim 1 \text{ mm/m}$ deflection @ 100 keV)

Lowest field at extraction : 94 G

Field sources:

- geomagnetic field
- DC and AC currents: power lines, busbars ...
- remanent magnetization in steel components (typical in welded/cold worked parts)
- electrical machinery (motors, pumps ...)

Field decays with distance from source r as $1/r^n$

Steel structures (beams, scaffolding, rebars in concrete etc.) may both shield or amplify locally the field according to the geometry, material properties, magnetic history

Magnetic field measured at 1.3 m from the floor as the crane passes overhead $\pm 2.5 \mu\text{T}$ B_{vertical} fluctuation correlated with the position of the beam.

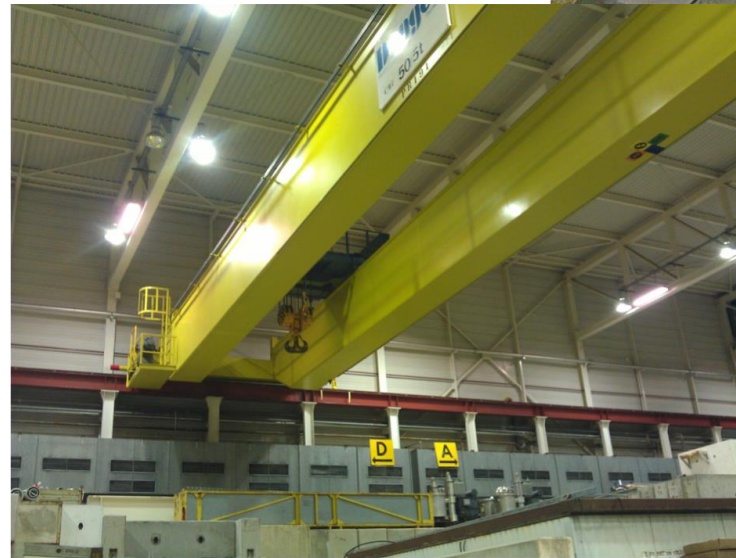
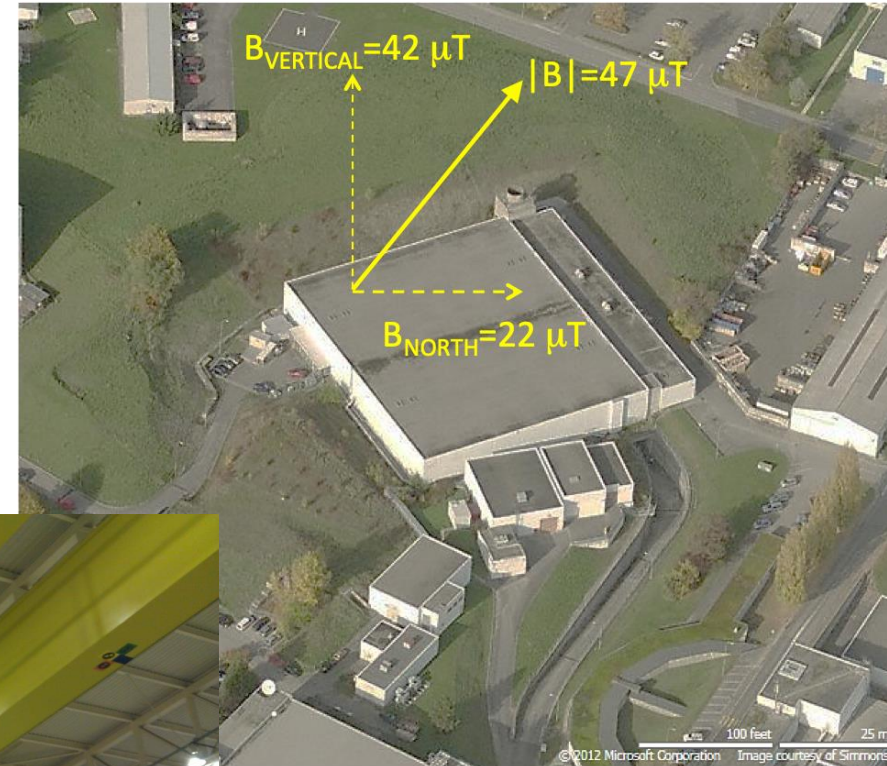

Daily and yearly change < 1%

From M. Buzio

Cockroft-Walton. Old CERN proton pre-injector

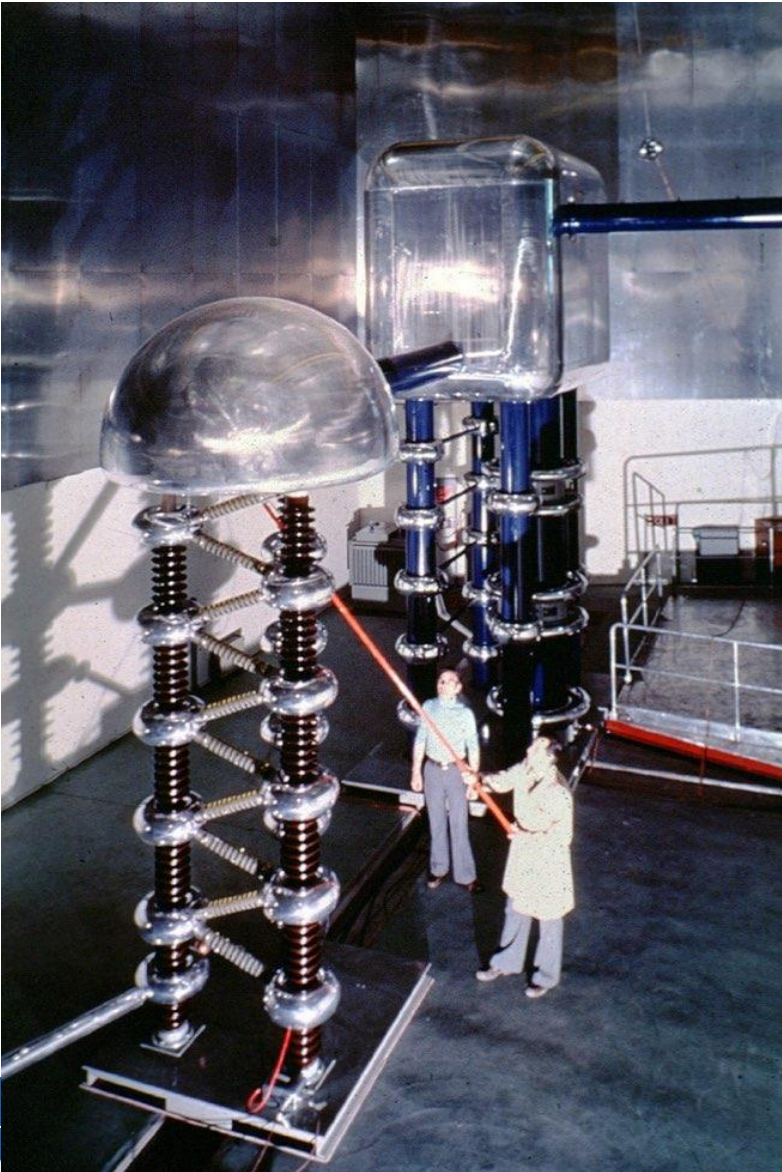

High voltage unit composed by a multiple rectifier system

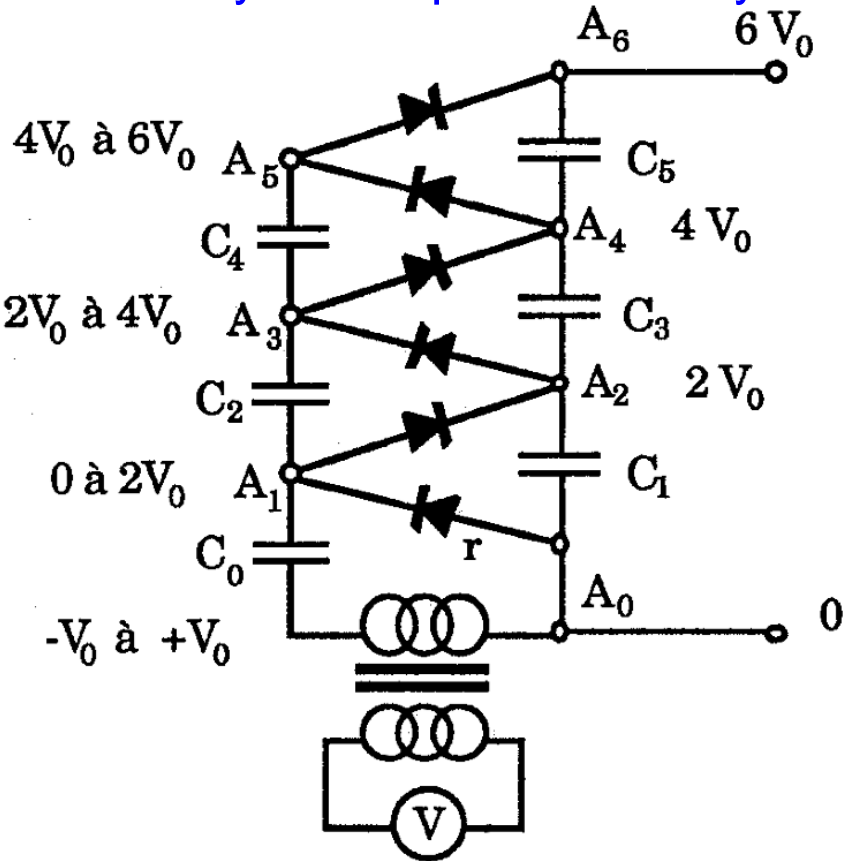

CERN: 750 kV

Accelerator



Experimental
Hall



Walton

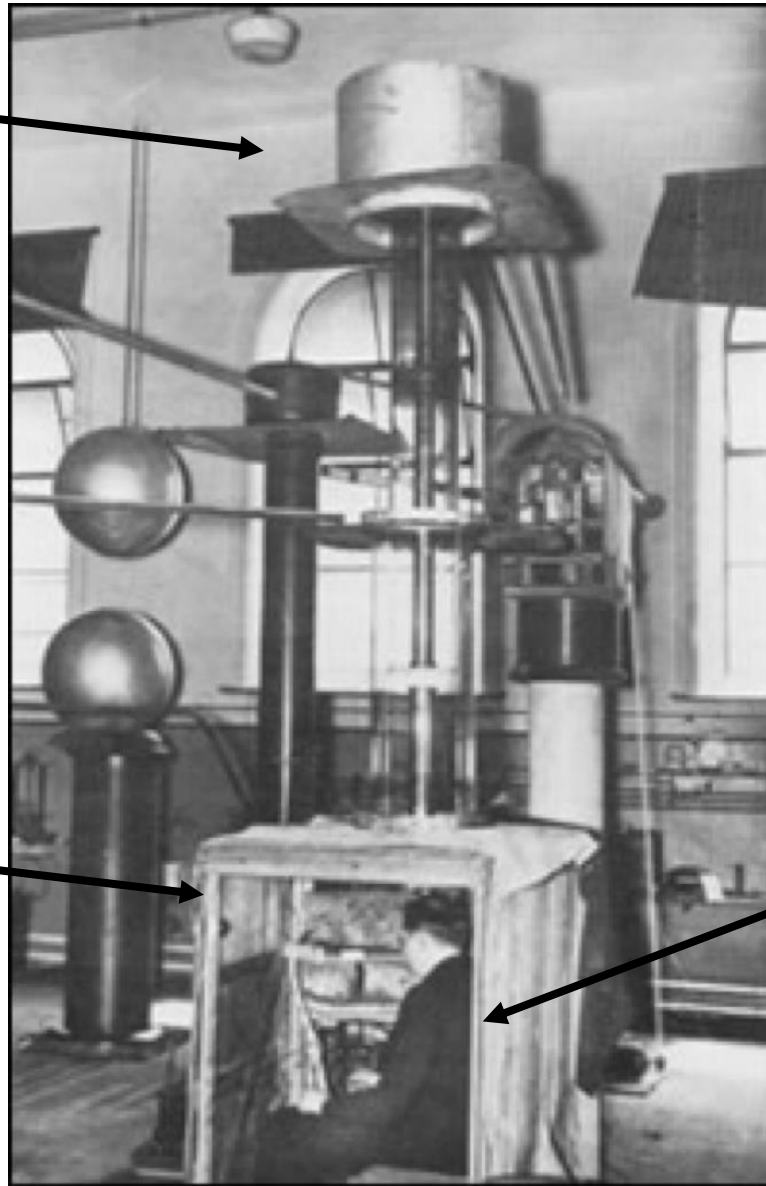
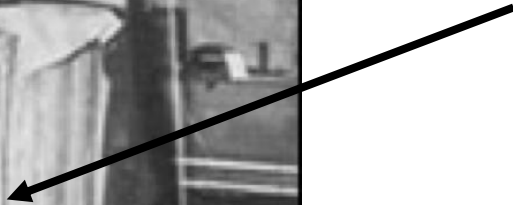

Walton and the machine used
to "split the atom"

Van De Graaf electrostatic generator (1928)

A rotating belt charges a top terminal up to the maximum voltage before sparking.

Maximum accelerating Voltage: 10 MV

Typical speed: 20 m/s

Height: 0.5 m

Top terminal: 1 MV - 10 MV

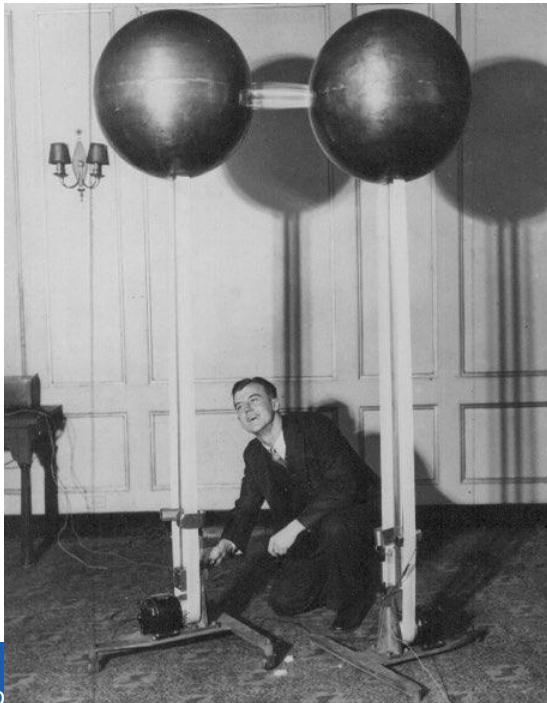

R. J. VAN DE GRAAFF WITH FIRST GENERATOR

© MIT Museum all rights reserved

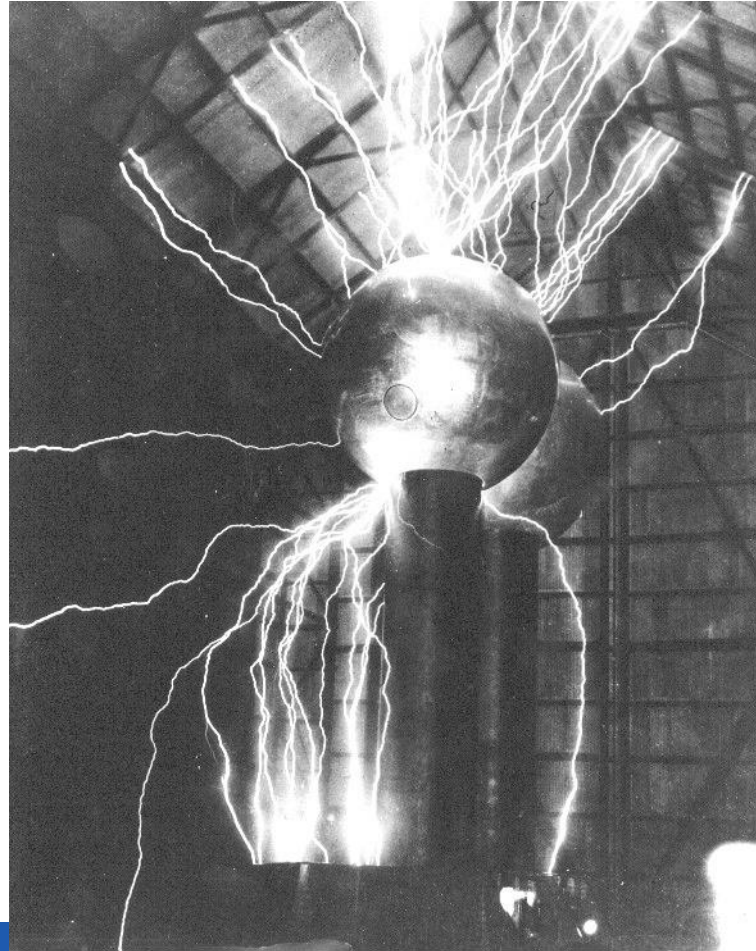

AT ROUND HILL SPARKING TO HANGAR (LONG EXPOSURE)

©MIT Museum All rights reserved

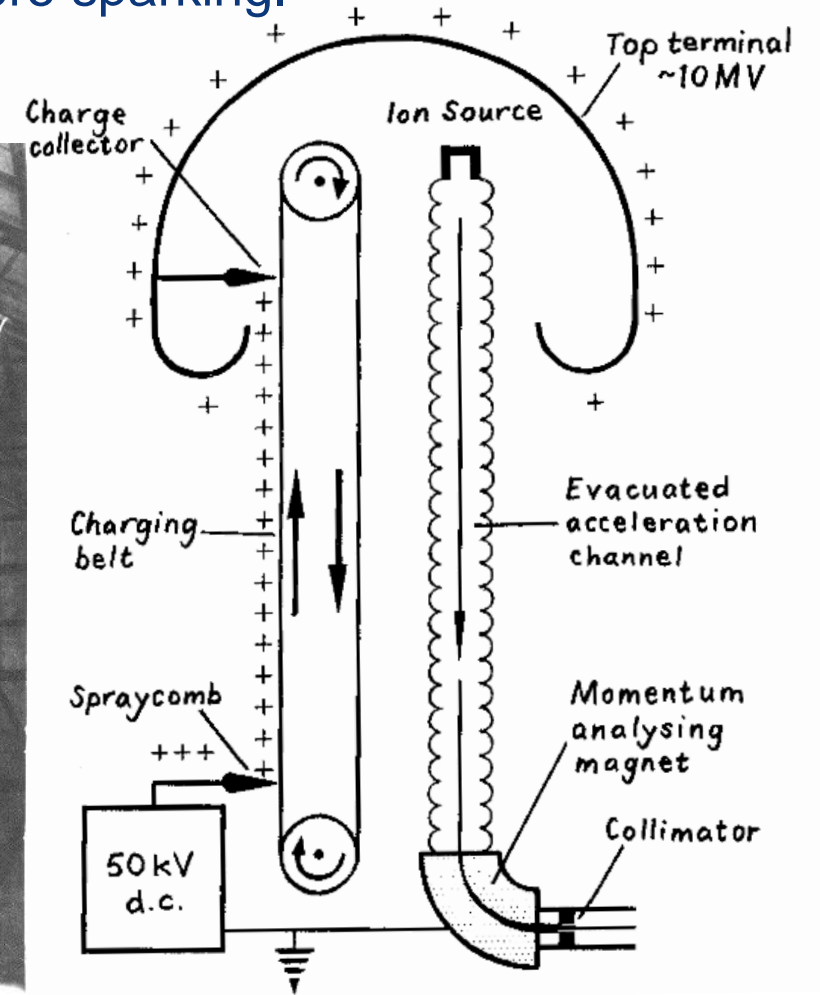

Tandem

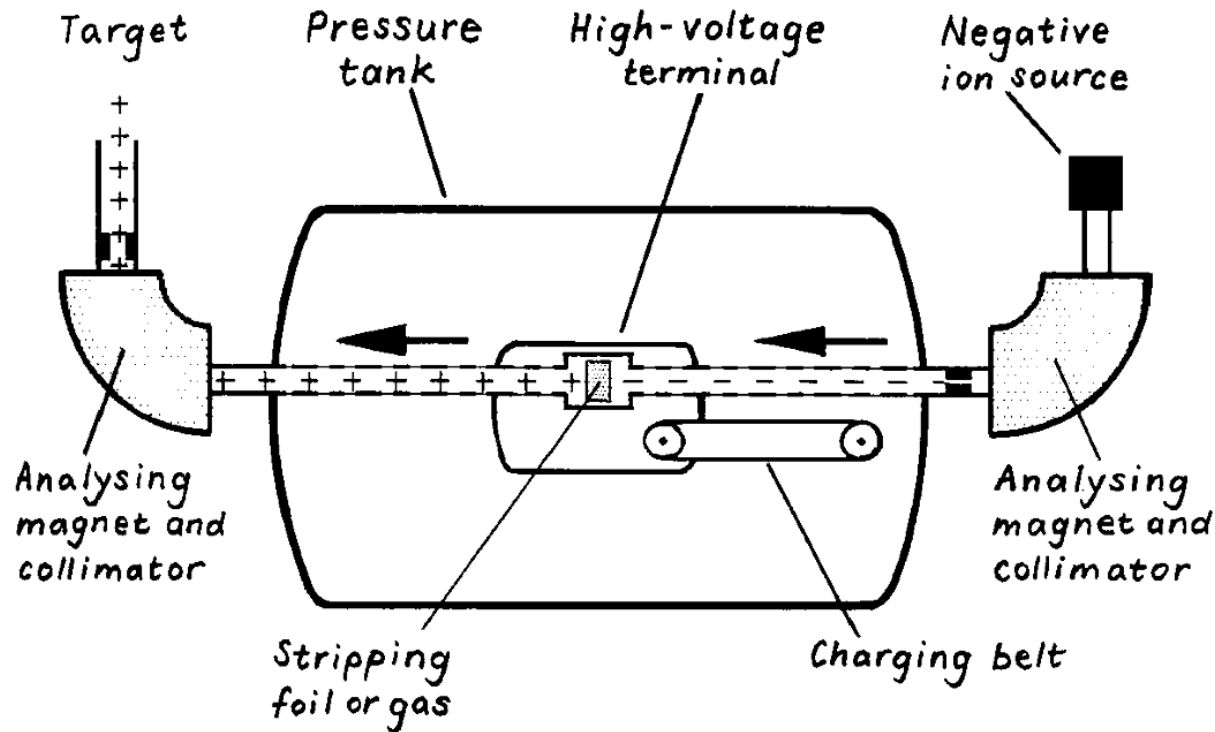

Application of Van der Graaf generator

- a) Source of negative ions (150 keV)
- b) Van Der Graaff column (25 MV)
- c) Stripping foil
change in charge
- d) Further re-acceleration

Everything in a pressurized vacuum tank

Since negative and positive multicharge states are used, different energies can be obtained



Current applications:

- a) Low energy injector for Ions
Still in use at Brookhaven (US) as injector for Cu and Au ions
- b) Compact system for "other uses" : Dating of samples at Louvre.

Application of Louvre Tandem: composition of scribe eyes

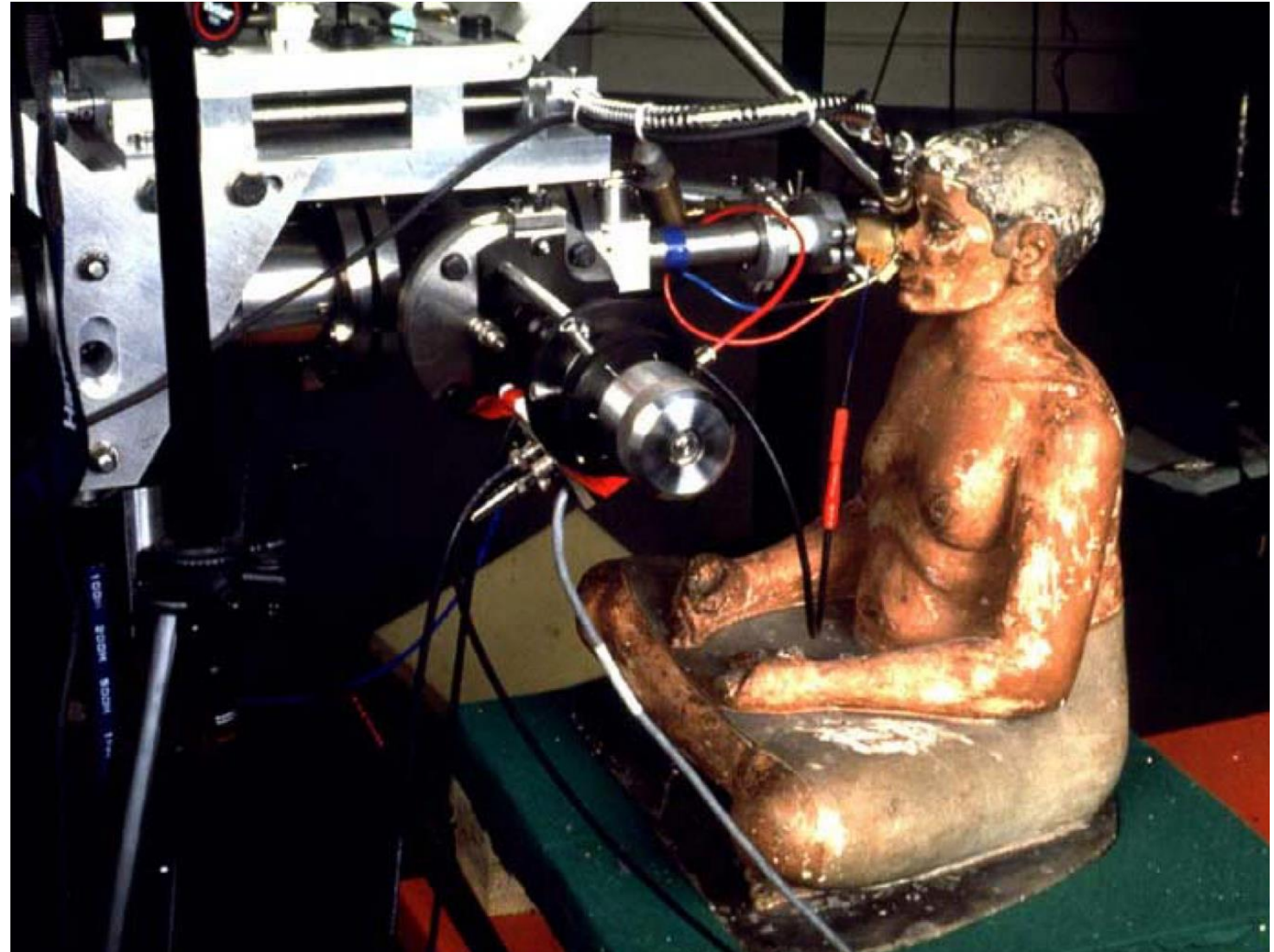
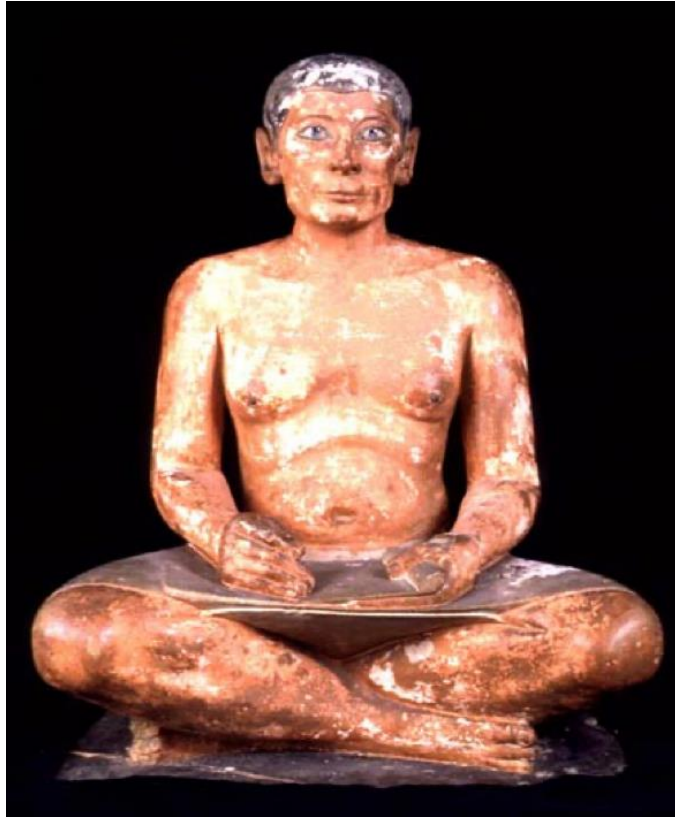

Discovering forgeries of modern art by the ^{14}C Bomb Peak



Contraste de formes, Fernand Leger (?)
Peggy Guggenheim Collection, Venice.

Accelerator Mass Spectrometry (AMS) to measure rare isotopes abundance with 3MV Tandatron accelerator of INFN-LABEC in Florence.

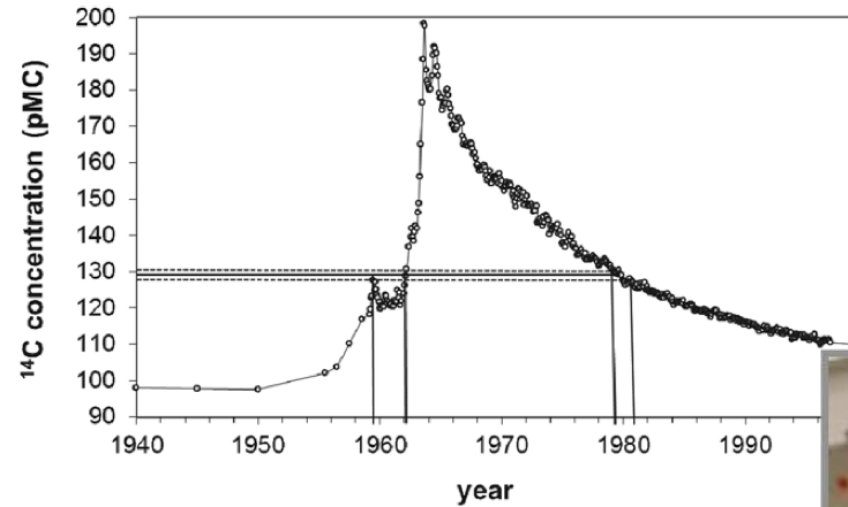

Eur. Phys. J. Plus (2014) **129**: 6
DOI 10.1140/epjp/i2014-14006-6

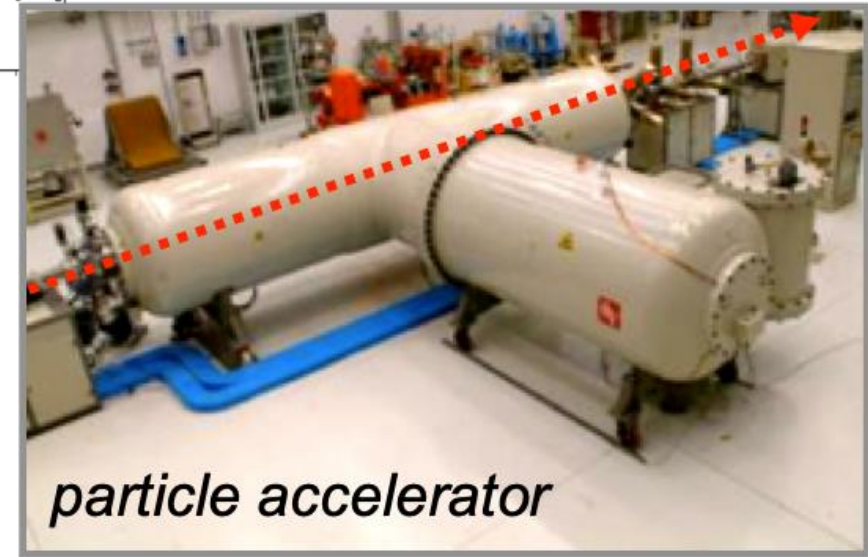

Synchrotron (1952, 3 GeV, BNL)

New concept of circular accelerator. The magnetic field of the bending magnet varies with time.

As particles accelerate, the B field is increased proportionally.

The frequency of the accelerating cavity, used to accelerate the particles, has also to change.

$B = B(t)$ magnetic field from the bending magnets

$p = p(t)$ particle momentum varies by the RF cavity

e electric charge

ρ constant radius of curvature

Bending strength limited by used technology to max ~ 1 T for room temperature conductors

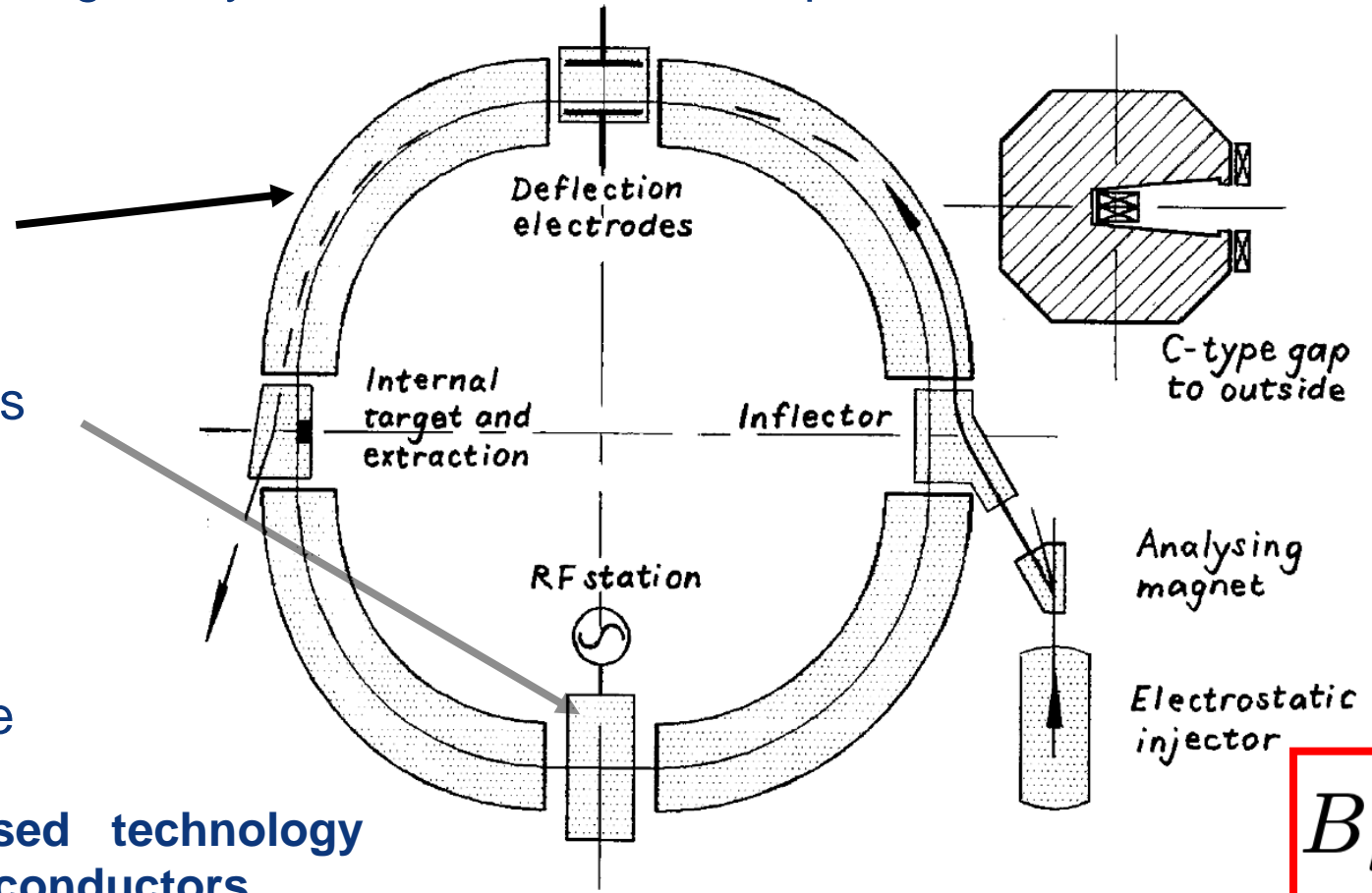

$$B\rho = \frac{p}{e}$$

Particle rigidity:

Synchrocyclotron

Synchrocyclotrons have a constant magnetic field with geometry similar to the uniform-field cyclotron. The main difference is that the rf frequency is varied to maintain particle synchronization into the relativistic regime.

