

# 2021 Update of the 380 GeV CLIC power consumption

Alexej Grudiev

CLIC project meeting

13/12/2021

# Outline

- Reminder
  - 2016 Power consumption estimate for the 1<sup>st</sup> stage optimization
  - 2018 Power consumption estimate for the Project Implementation Plan (PIP)
- Update for 100 Hz operation for high luminosity studies in 2019
- Update for the new DR design proposal, 2021
- Update for the new DB klystron parameters, 2021
- Summary

N.B. In the following slides power consumption estimate always refer to the CLIC 380 GeV Drive beam baseline option

# 380 GeV CLIC layout and power consumption

## Updated baseline for a Staged Compact Linear Collider, CERN-2016-004, 2016

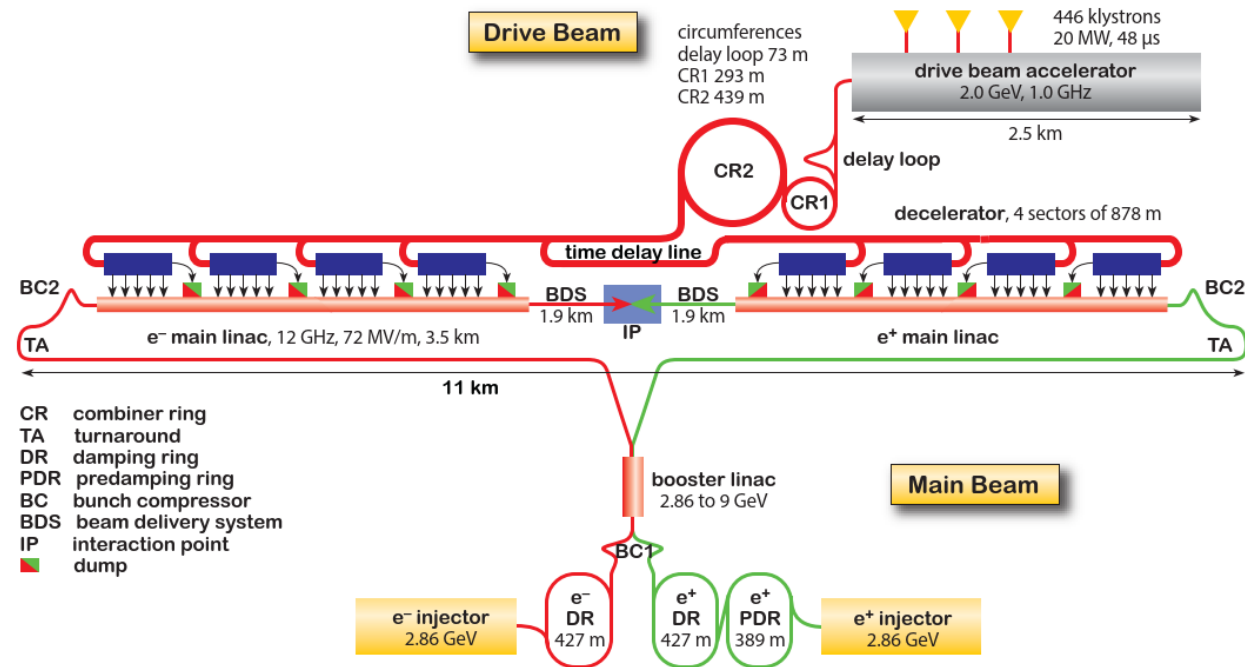
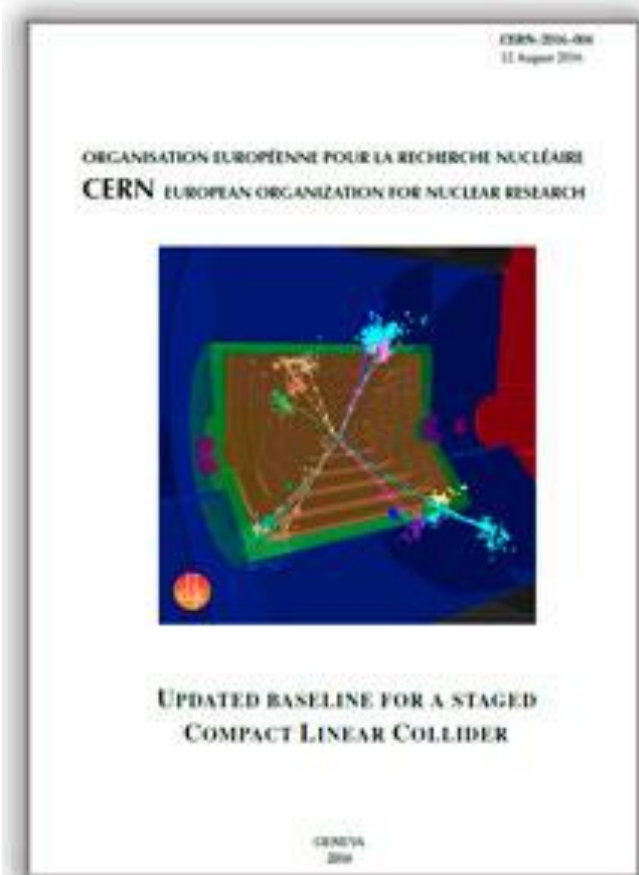

- Total power consumption of 380 GeV CLIC was estimated to be **252 MW**
- It was estimated using parameterized model [\*] derived from the CDR power estimates at 3, 1.5 and 0.5 TeV stages and used for 1<sup>st</sup> stage optimization
- \* B. Jeanneret, CLIC Total Electrical power: a parametrization, CERN-ACC-Note-2013-0020, 2013

# Power consumption estimate for PIP in 2018

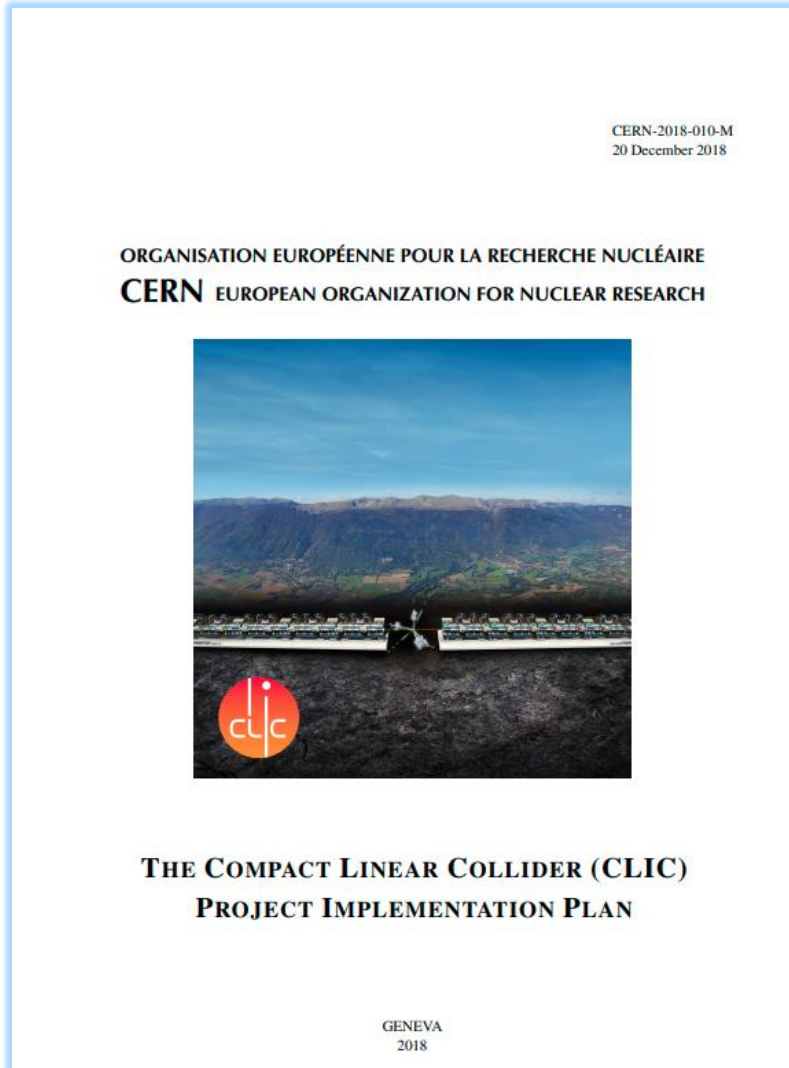

- **Motivations:**
- Parameterized model used in 2016 required verification at 380 GeV
- Several changes in the design parameters had been made:
  - Development of high efficiency klystrons
  - (Pre-)Damping rings bunch-to-bunch spacing reduced from 1 ns to 0.5 ns
  - Drive beam energy is reduced from 2.4 to 2.0 GeV
  - Different design of the BDS at 380 GeV
- Alternative klystron-based option of the first stage at 380 GeV needed power consumption estimate as well.
  
- **Assumptions**
- Project breakdown structure (**PBS**) of the **costing tool** has been used in order to insure the consistency of the power and the cost estimate
- **Expected Operating** (not the specification) **values** have been consistently used for the RF and magnet systems

# Comparison: 2016 vs 2018

252 MW

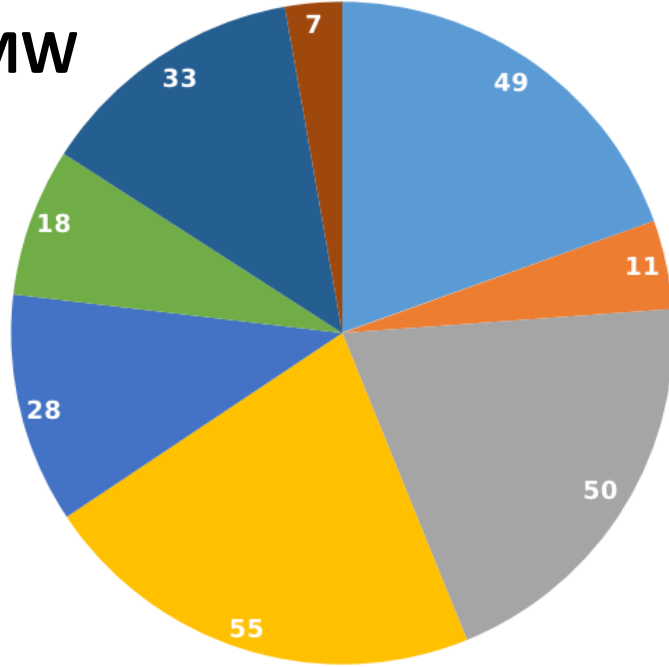

- DB linac
- DB frequency multiplication & transport
- MB production
- MB damping rings
- MB booster linac & transport
- Main linacs
- BDS & experiment
- Instrumentation & Control

Significantly smaller power consumption in the area of MB injector, booster and transport as well as in the BDS has been found

Drive beam option: 165 MW

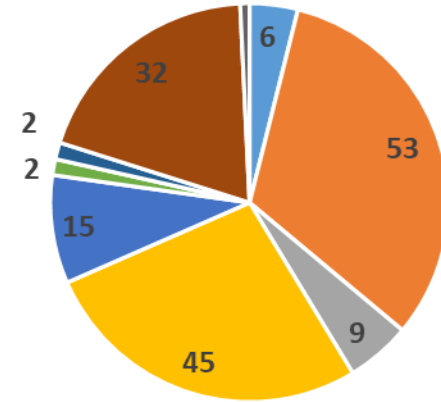

- MB Injectors
- MB Damping Rings
- MB booster & Transport
- DB Injectors
- DB Frequency Multiplication & Transport
- Two-beam accelerators
- Interaction Region
- Infrastructure and Services
- Controls and Operation

Experiment is not included

- The summary data plot is part of PIP document.
- All the details behind the plot are unpublished
- Reference: A. Grudiev, *private communication*

# Distribution of dissipated and beam powers

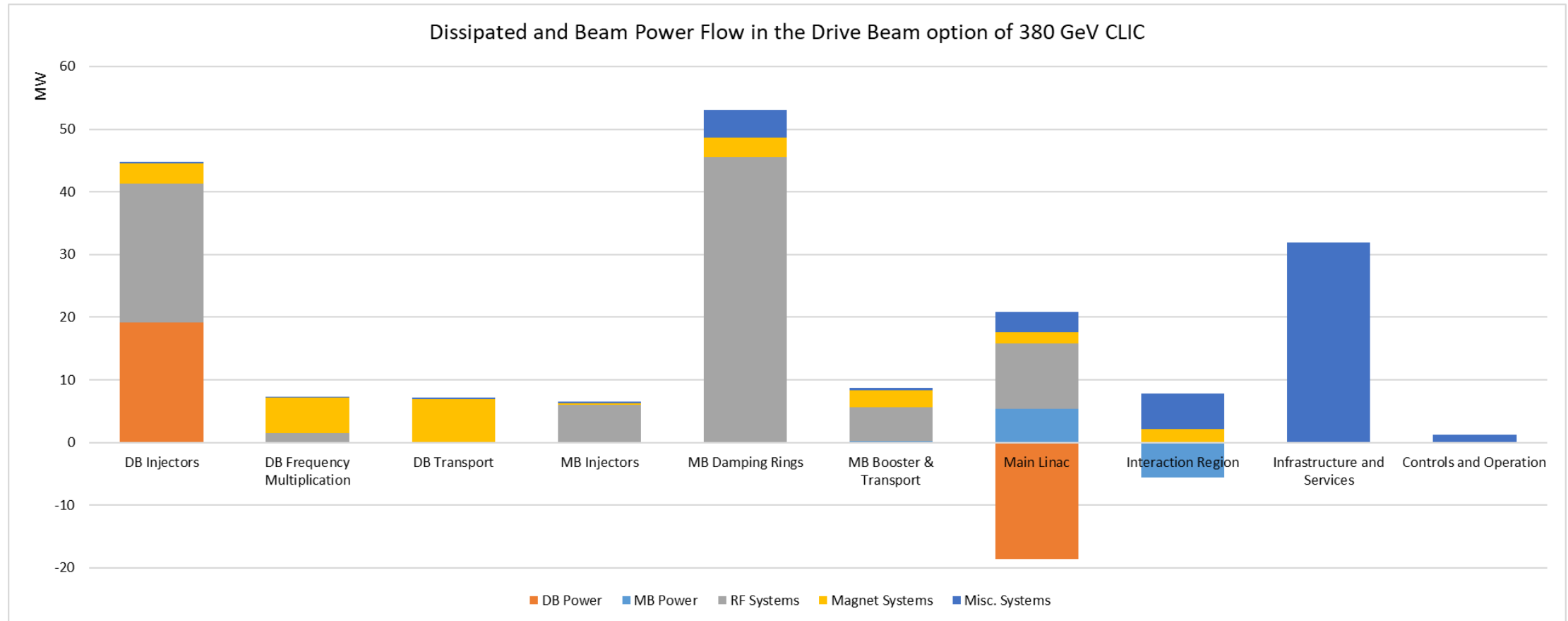

# Power increase for operation at 100 Hz

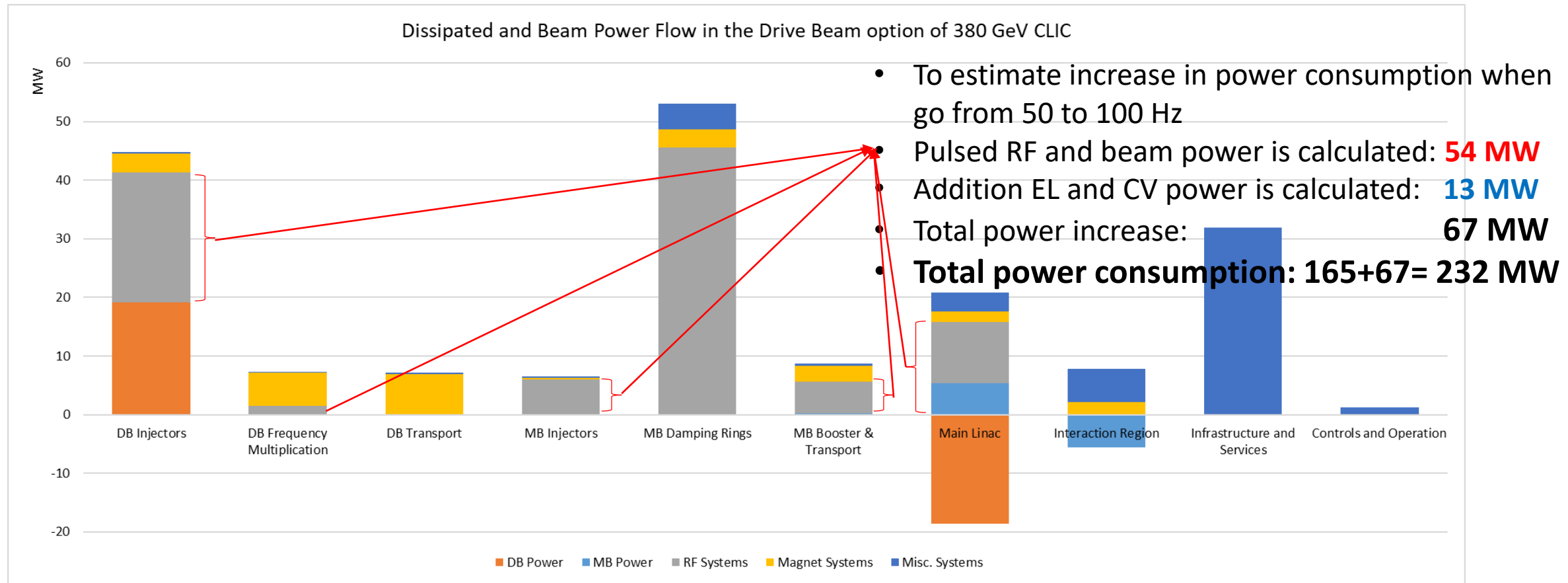

This estimate was mentioned in CLIC – Note – 1143: HIGH-LUMINOSITY CLIC STUDIES

# CLIC DRs

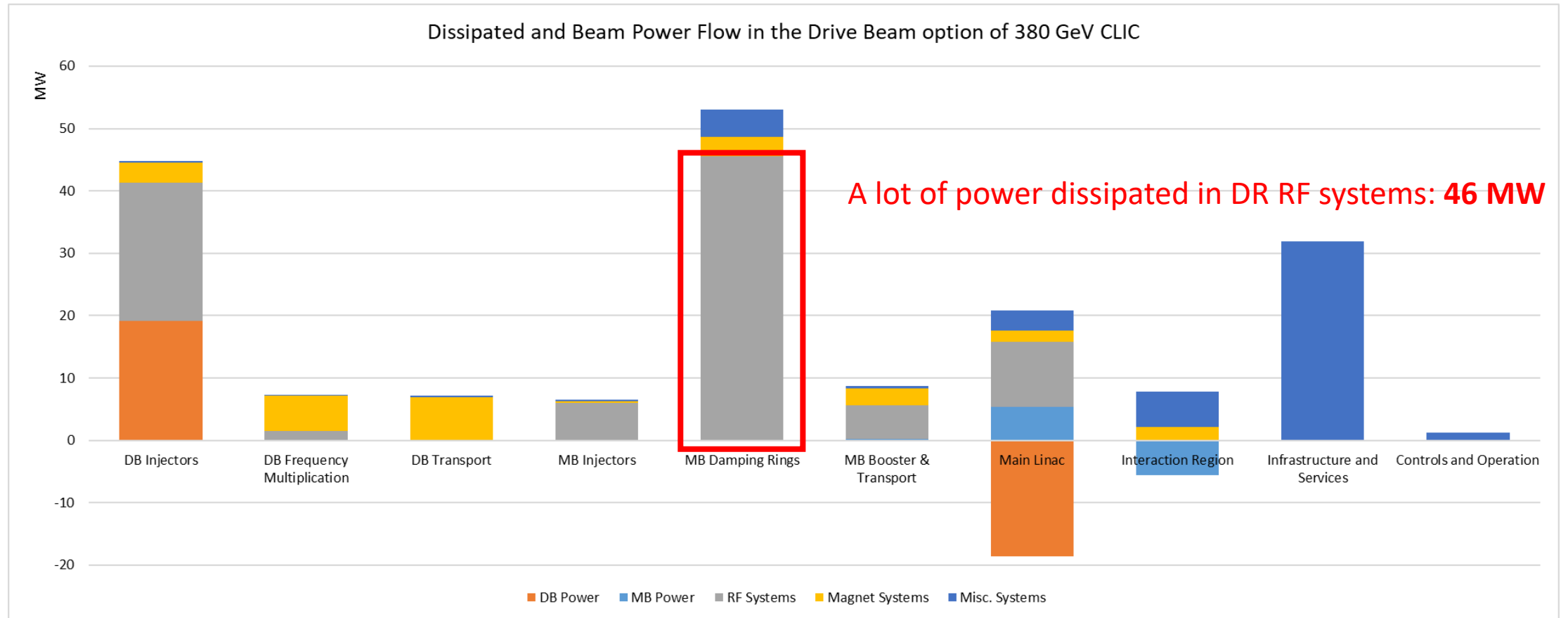



# 380 GeV CLIC DR parameters (PRAB22, 091601)

Parameter of DR		value	unit
Energy	E	2.86	GeV
Circumference	C	373.7	m
Revolution frequency	$f_0$	802	kHz
RF frequency	$f_{RF}$	2	GHz
Harmonic number	h	2493	
Energy loss per turn	$eV_A$	5.8	MeV
RF voltage	$V_C$	6.5	MV
RF stable phase	$\phi$	-26.8	°
Bunch population	$N_e$	5.7	1e9
Number of bunches per train	$N_b$	352	
Number of trains	$N_t$	1	
Peak beam current	$I_b$	1.8	A

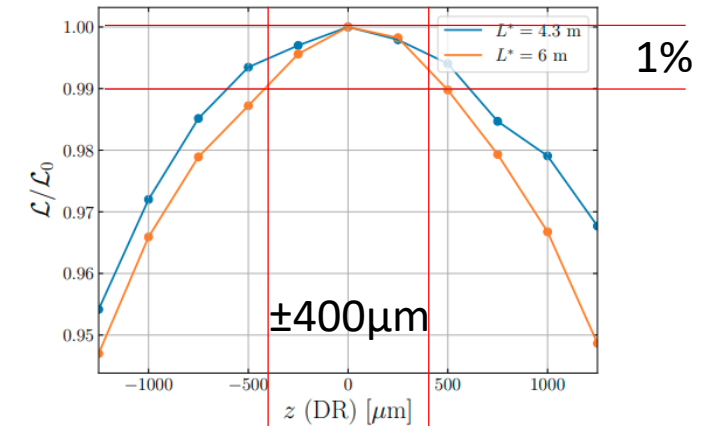

Figure 10: Luminosity against the longitudinal bunch position from the DRs.

Strict specifications on the bunch spacing variation:  $\delta\phi_b < \pm 1^\circ$  at 2 GHz ( $\pm 400\mu\text{m}$ ) for Luminosity loss  $< 1\%$  (CLIC-Note-1138)

This is difficult to maintain due to strong transient beam loading effects caused by large difference between **peak** and **average beam power** values of 10.4 MW and 1.5 MW, respectively

# CLIC DR summary of PIP baseline

Cavity type	ARES
Cavity R/Q [ $\Omega$ ]	<b>7.5</b>
Number of cavities	32
Cavity Q0	55000
BL compensation method	feedforward
Beam phase variation [ $^\circ$ ]	<b><math>\sim 1</math></b>
Peak input power [kW/cavity]	405
Cavity power loss [kW]	$\sim 50$
Total peak input power [kW]	12960

- **Very high peak power**
- **Larger klystron bandwidth**
- **Strong peak power modulations on each turn**
- **Inefficient due to most of average power lost**

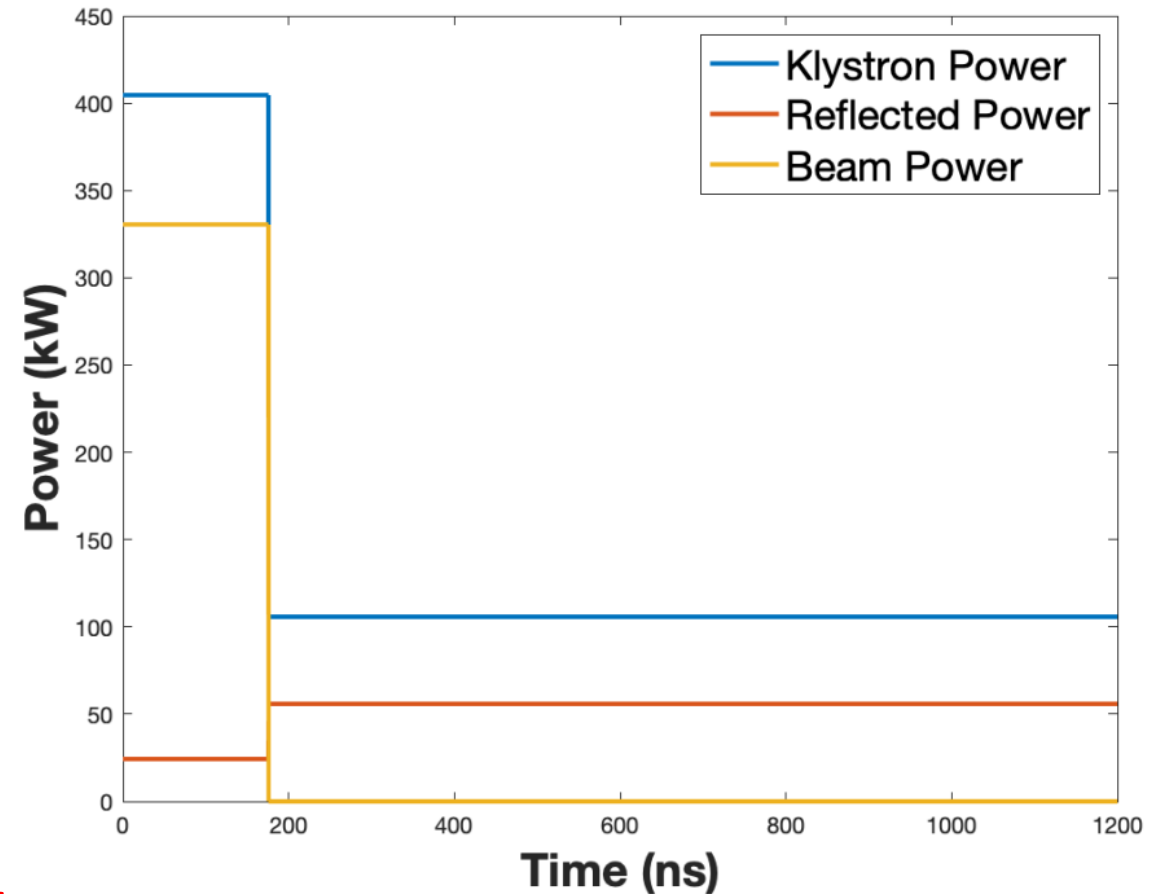

(NIMA V985, 164659, 2021)

# Design philosophy for Ultra low R/Q RF cavity

- Increase cavity aperture to reduce loss factor => reduce R/Q per cavity
- Increase cavity length to reduce transit time factor => reduce R/Q per cavity
- Optimize cavity wall shape to minimize H-field to reach largest stored energy per cavity under the H-field limit of **80 kA/m** (100 mT, private communication, W. Venturini, 2021) => reduce number of cavities
- R/Q per cavity x N of cavities must be below Total R/Q: **14.3  $\Omega$**

More details in: CLIC-note-1173, or in [rf development meeting \(22 September 2021\)](#)

# Novel cavity: Barrel Cell Cavity (BCC) geometry

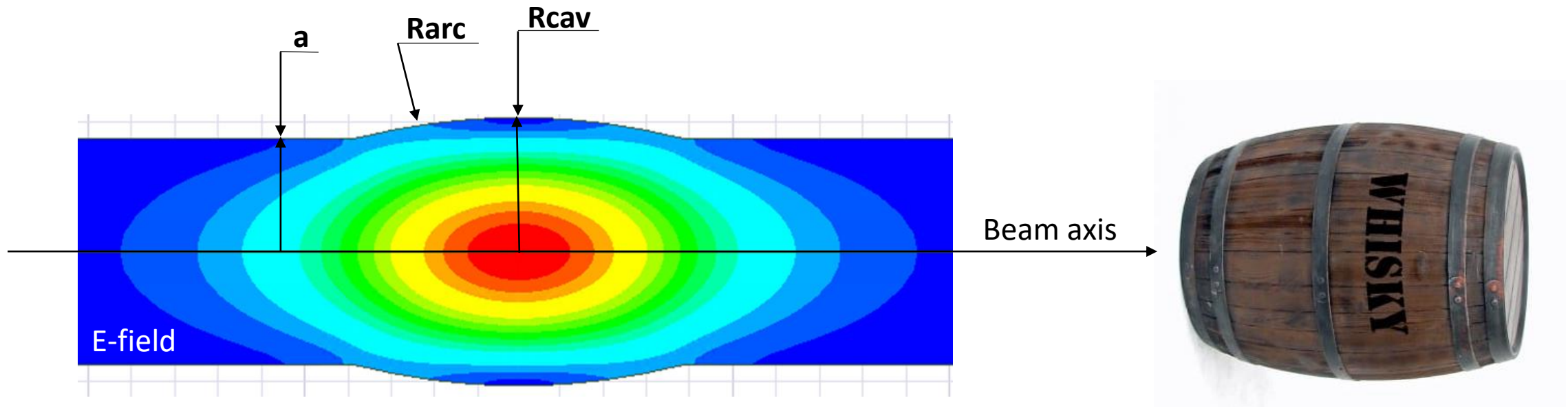

- Large aperture => low R/Q
- Long cell:  $\sim \lambda$  => low transit time factor
- Low field on the cavity wall

# Design of the cavity for total $R/Q=14.3\Omega$

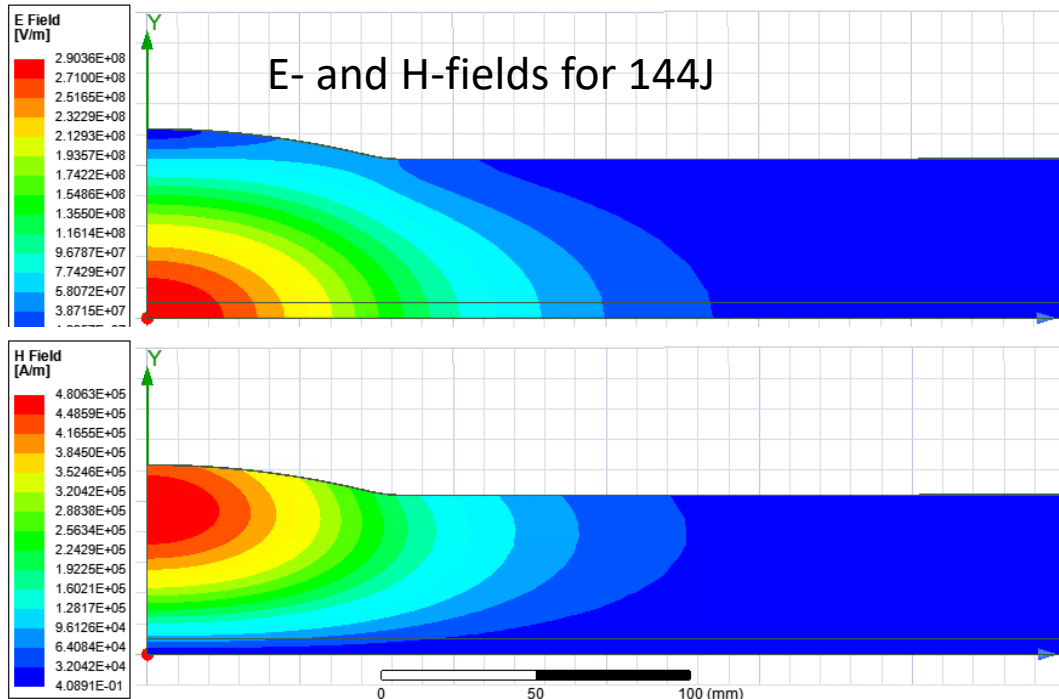

TM011	
a [mm]	52
f [GHz]	2
a/λ	0.347
Lc [mm] (0.01Hmax)	~520
Rarc [mm]	307
Rcav [mm]	61.95
<b>R/Q [Ω]</b>	<b>0.6</b>
E <sub>max</sub> /V <sub>acc</sub> [1/m]	31.6
H <sub>max</sub> /V <sub>acc</sub> [mA/Vm]	291

To get this design parameters, two conditions must be met:

R/Q per cavity is  $14.3\Omega/N_{cav}$

AND

V<sub>max</sub> per cavity is  $6.5\text{MV}/N_{cav}$

**N<sub>cav</sub> = 24**

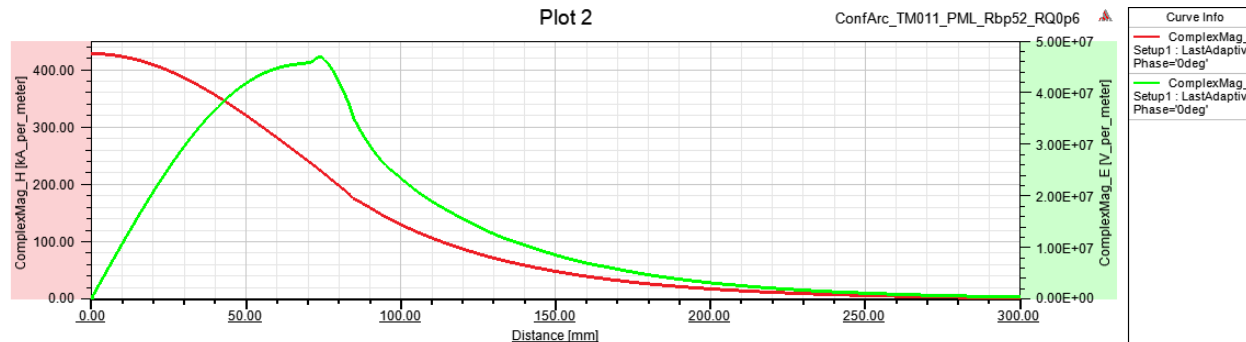

H<sub>max</sub> limit: 80kA/m  
 $\Rightarrow$  V<sub>max</sub> = 0.275 MV  
 $\Rightarrow$  U<sub>max</sub> = 5.0 J  
 $\Rightarrow$  E<sub>max</sub> = 8.7 MV/m

# All LOM and HOMs damped

## The magic flute helps to damp dipole LOM

Particle Accelerators, 1992, Vol. 40, pp.17-41  
 Reprints available directly from the publisher  
 Photocopying permitted by license only

©1992 Gordon & Breach Science Publishers, S.A.  
 Printed in the United States of America.

One of the BCC beam pipes is 'fluted' using 4 longitudinal grooves to reduce TE<sub>11</sub> WG mode cutoff from 1.69 GHz to lower value and let TE<sub>111</sub> mode at f=1.59 GHz escape.

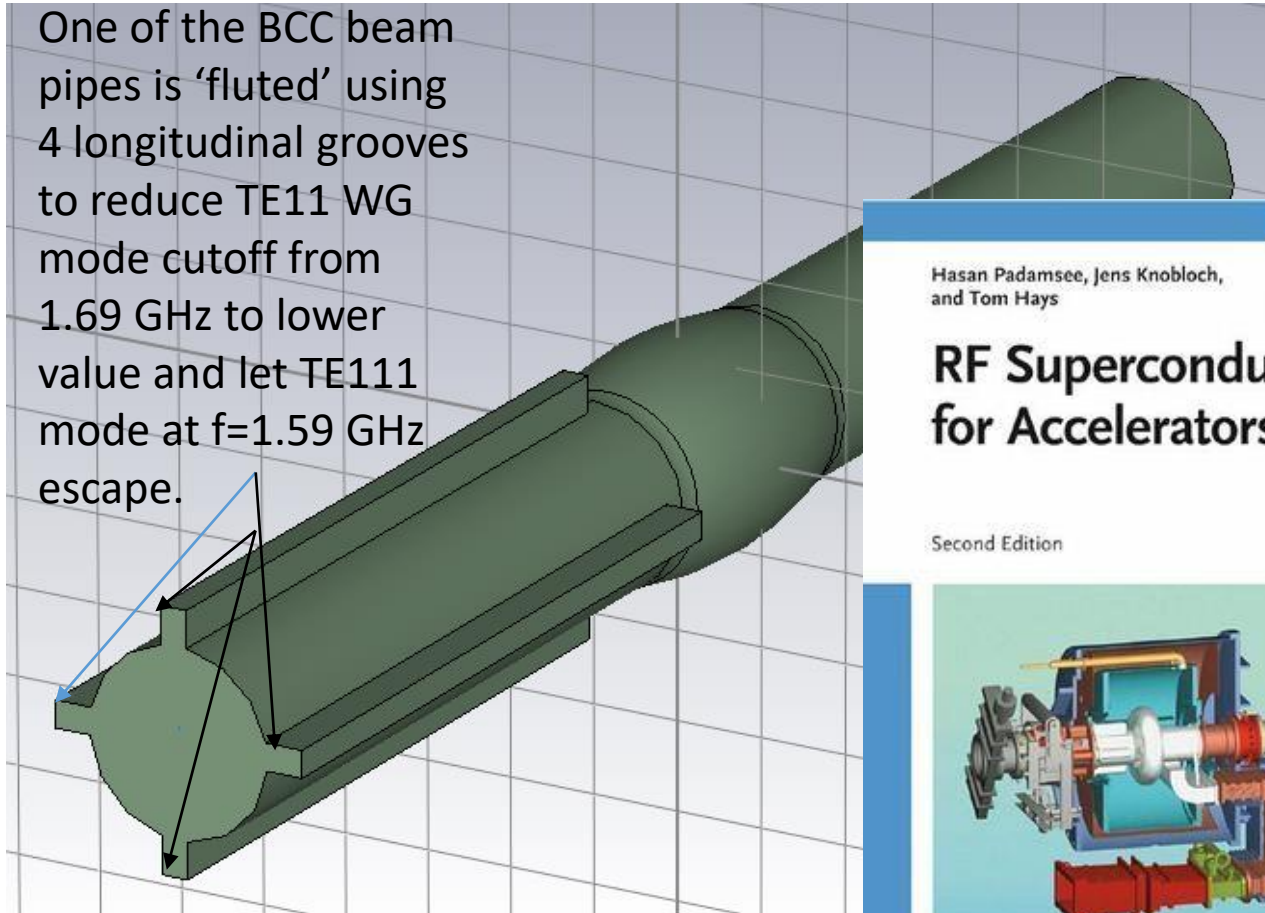

Hasan Padamsee, Jens Knobloch,  
and Tom Hays

WILEY-VCH

### RF Superconductivity for Accelerators

Second Edition

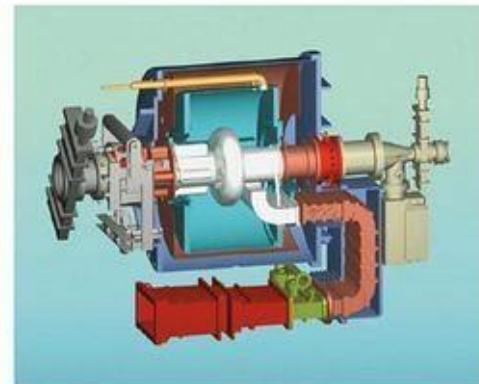

## DESIGN CHALLENGES FOR HIGH CURRENT STORAGE RINGS\*

H. PADAMSEE, P. BARNES, C. CHEN, W. HARTUNG, J. KIRCHGESSNER,  
 D. MOFFAT, R. RINGROSE, D. RUBIN, Y. SAMED, D. SARANITI, J. SEARS,  
 Q.S. SHU and M. TIGNER

Laboratory of Nuclear Studies, Cornell University

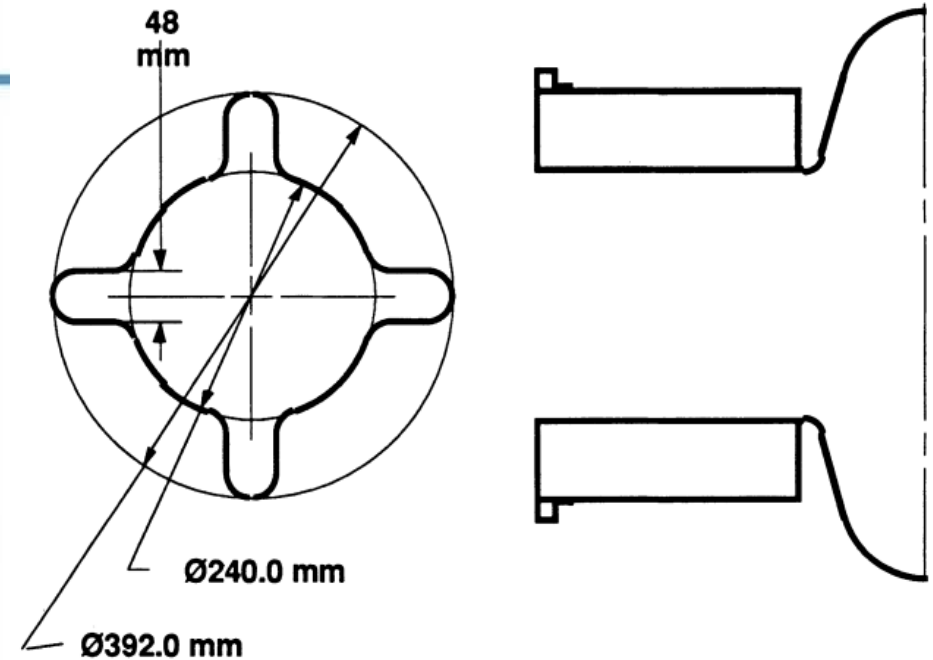





FIGURE 5: Geometry of fluted beam pipe

# Summary table. More details : CLIC-note-1173, or in [rf development meeting](#)

Case	1	2	3	4
Cavity R/Q [ $\Omega$ ]	0.6 		2.04	
a [mm]	52		50	
Lc [mm] (0.01Hmax)	520		500	
Rarc [mm]	307		160	
Rcav [mm]	61.95		63.55	
Total R/Q [ $\Omega$ ]	14.3	7.15	28.6	14.3
Bunch phase variation [ $^\circ$ ] @2GHz	1	0.5	<b>2</b>	1
<b>Ncav</b>	<b>24</b>	12	14	7
Cavity input power Pin [kW]	60	120	103	<b>206</b>
Bmax [mT]	100 	<b>200</b>	100 	<b>200</b>
Hmax [kA/m]	80	160	80	160
Emax [MV/m]	8.7	17.4	11.7	23.4
Cavity voltage Vc [MV]	0.275	0.55	0.47	0.94
Cavity stored energy Uc [J]	5.0	20.0	4.3	17.1



# LLRF simulation results

Design	$\Delta f$ (Hz)	$Q_L$	Peak power per klystron (kW)	Total peak power (MW)	$\phi_b$	$\Delta\phi$
1	-514	983e3	62.2	1.49	-26.8°	<b>0.99°</b>
2	-257	1962e3	125	1.49	-26.8°	<b>0.49°</b>
3	-1020	496e3	107	1.49	-26.8°	<b>1.99°</b>
4	-510	990e3	213	1.49	-26.8°	<b>0.98°</b>

T. Mastoridis

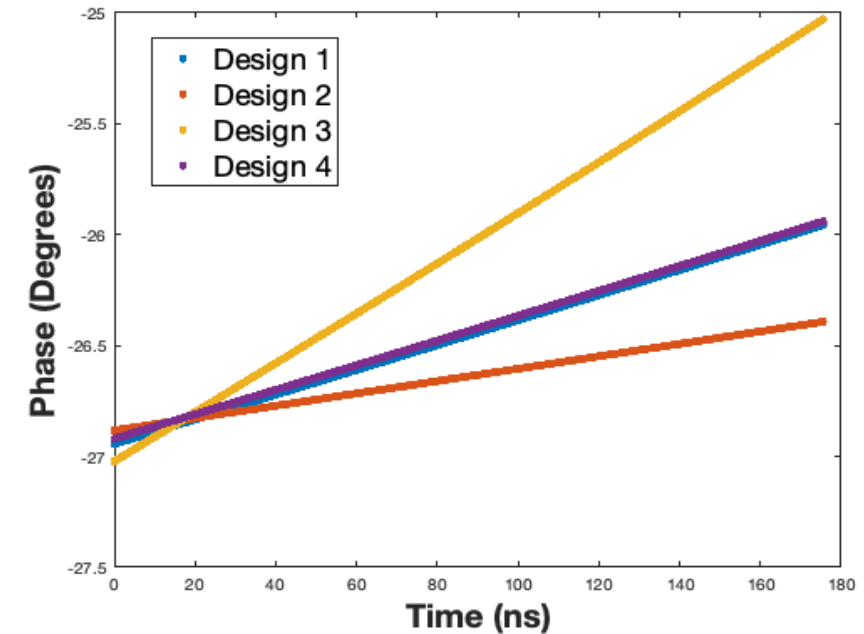
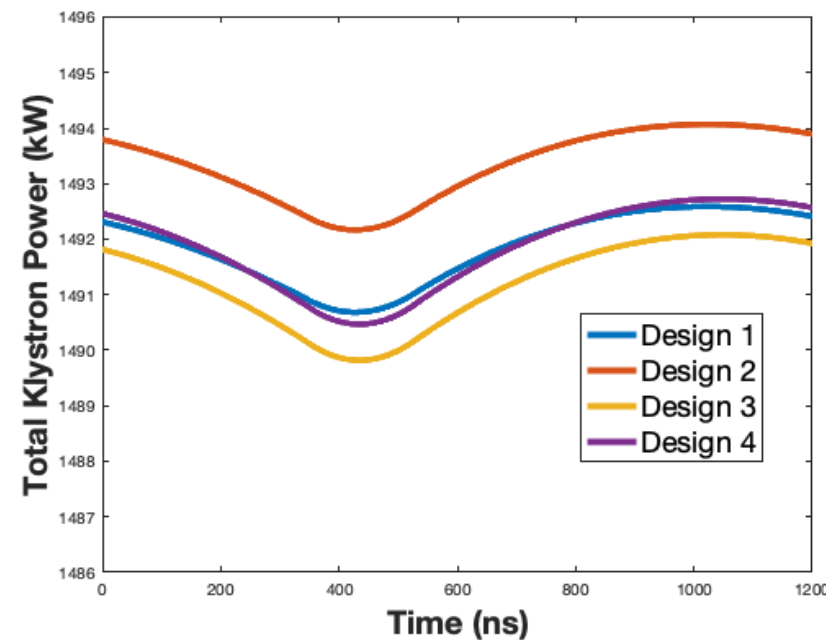
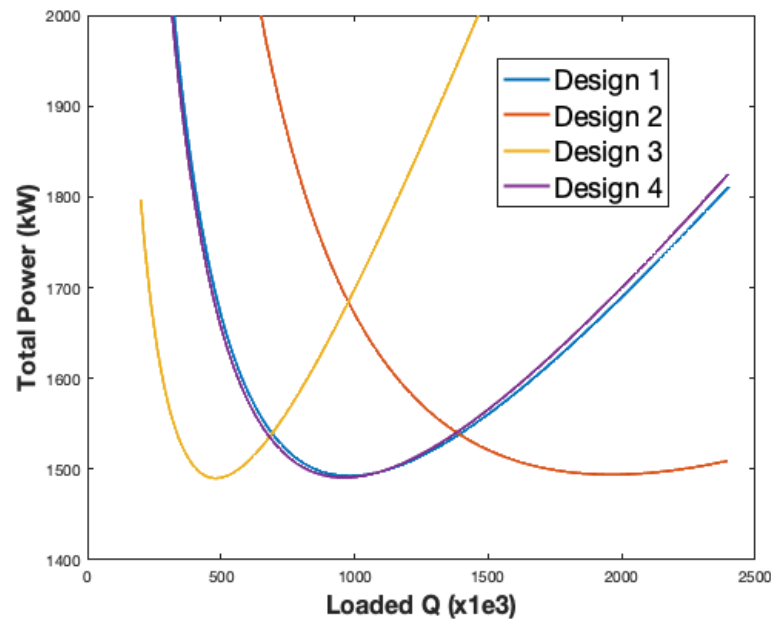

Due to the very high cavity filling time, the closed-loop response of the RF/LLRF system is slow. In addition, there is a 350 ns delay in the RF loop. Very small klystron power modulation



# Comparison: PIP baseline vs new proposal

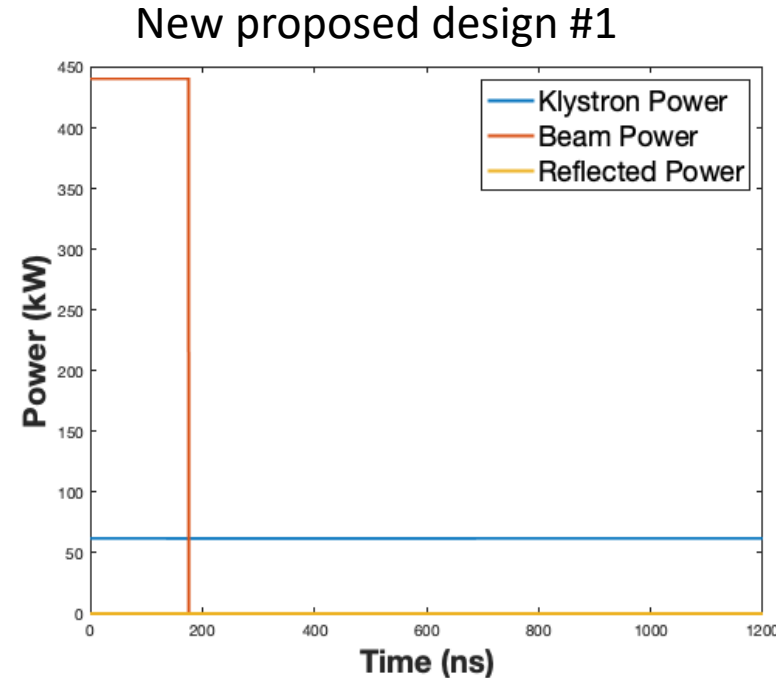
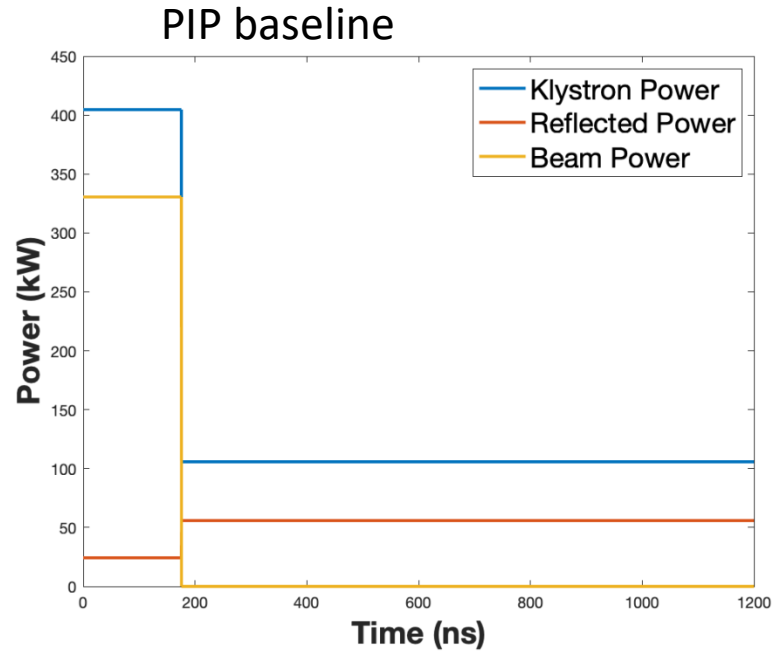

Cavity type	ARES	BCC
Cavity R/Q [ $\Omega$ ]	<b>7.5</b>	<b>0.6</b>
N of cavities	32	24
Peak input power [kW/cavity]	405	62.2
Total peak input power [MW]	<b>13</b>	<b>1.5</b>

- RF power match the average beam power => efficient
- No klystron power modulation => no large bandwidth
- Peak power requirements are SIGNIFICANTLY reduced => cost, size

# Comparison DR: PIP baseline vs new proposal

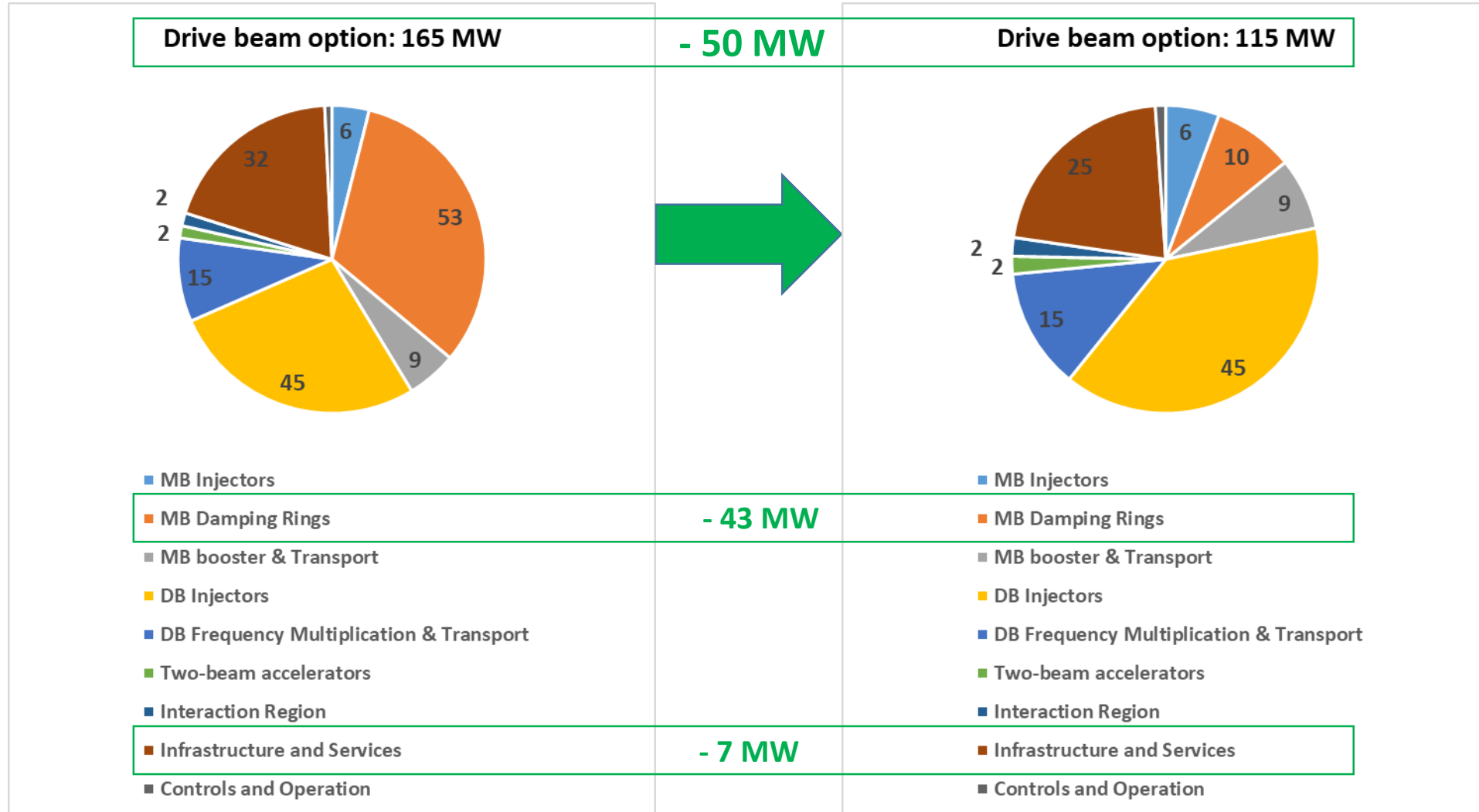

# CLIC DRs: power reduction due to new design

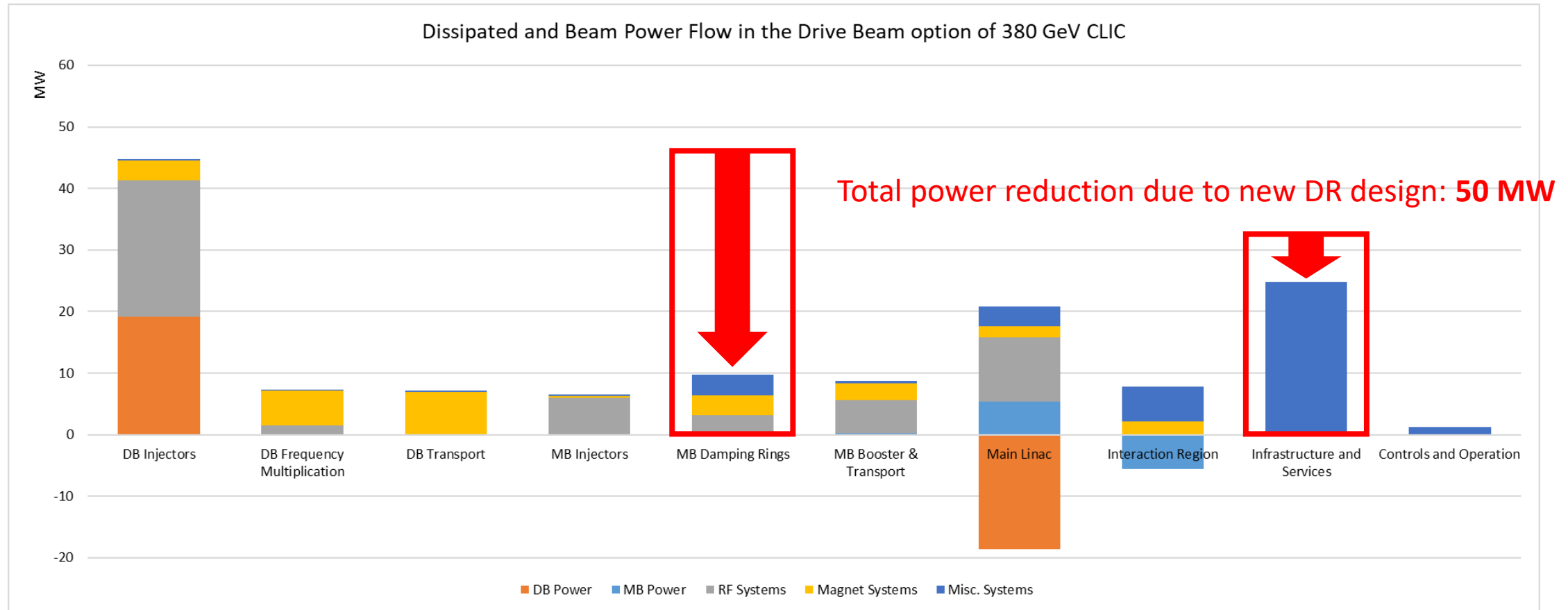

# Drive beam injector complex

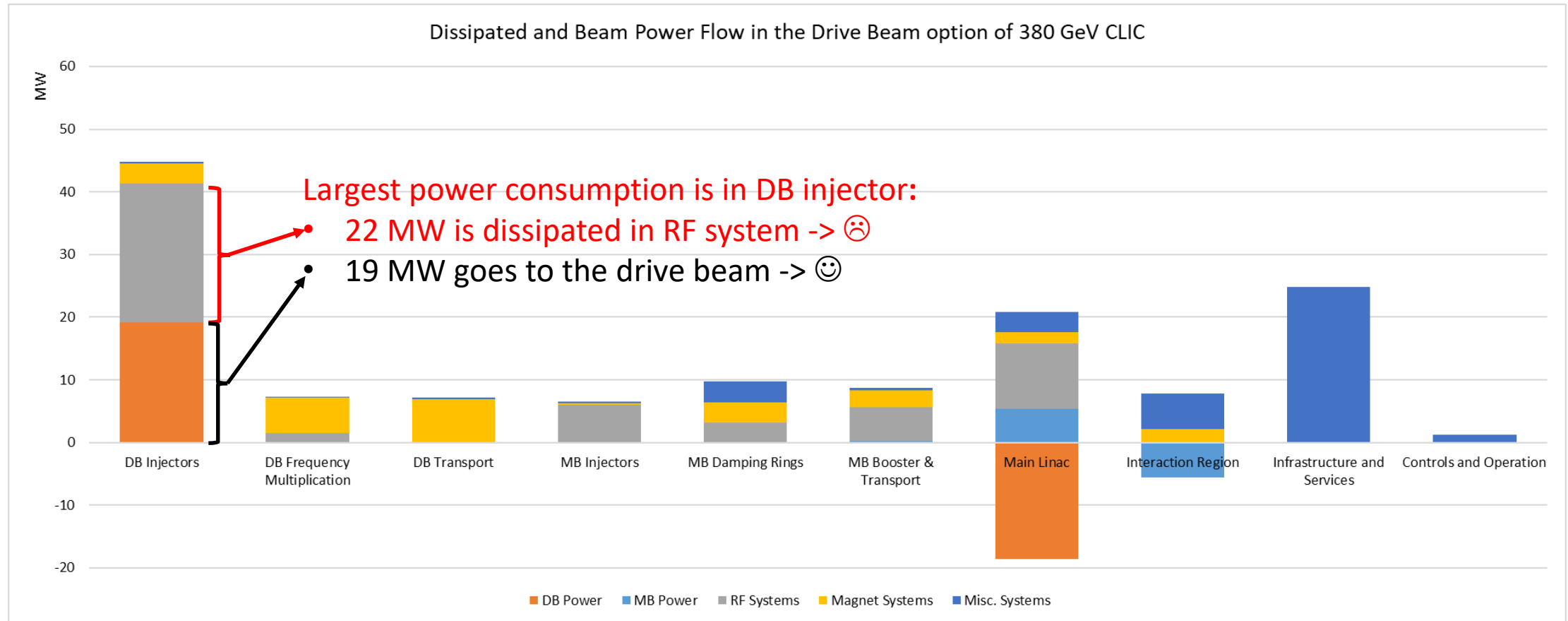

# New ideas for CLIC 1GHz klystron for DB linac

## High Efficiency 24 MW, 1 GHz, **CLIC TS MBK** performance summary (PIC CST/3D)

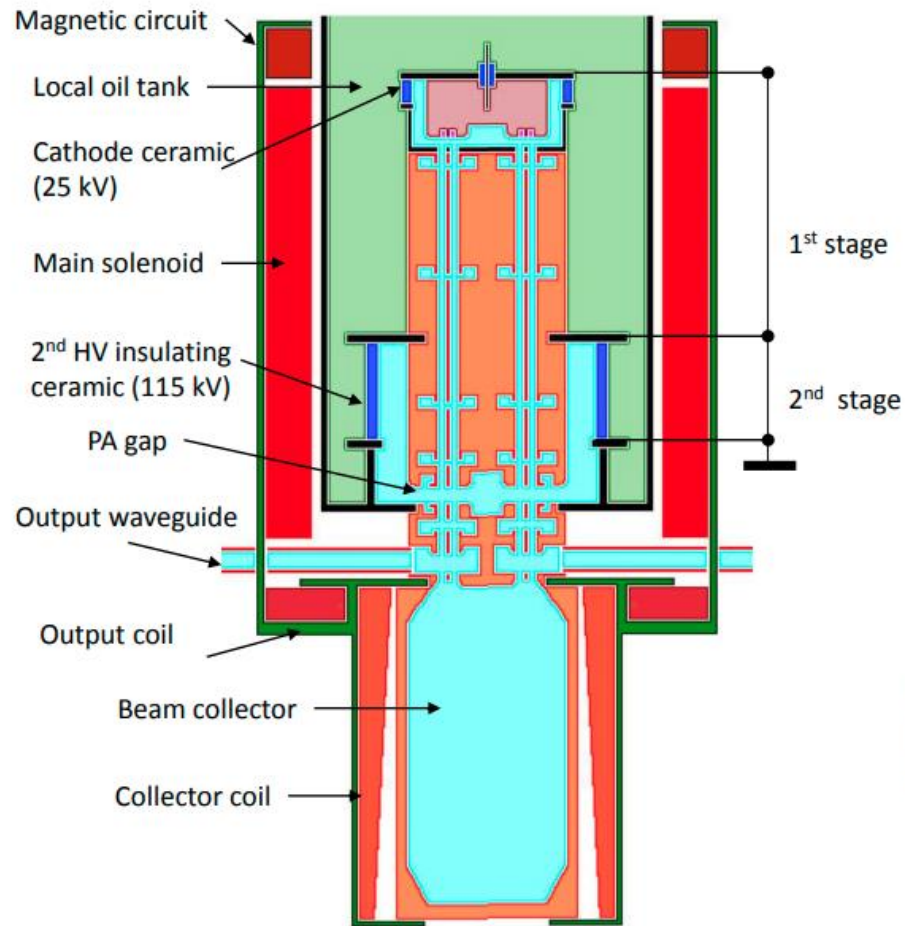

TABLE I. DESIGN AND SIMULATED PARAMETERS (CST/3D) OF THE CLIC TS MBK AND CANON MBK E37503 CATALOGUE DATA

Parameter	TS MBK	E37503	Unit
Operating frequency	1000	1000	MHz
Voltage at the 1 <sup>st</sup> stage	25	160	kV
Voltage at the 2 <sup>nd</sup> stage	140		
Total beam current	212	180	A
Number of beamlets	30	6	
Number of cavities	6	6	
Perveance at the 1 <sup>st</sup> stage	1.77	0.47	$\mu\text{A}/\text{V}^{3/2}$
Perveance at the 2 <sup>nd</sup> stage	0.133		
Output RF power	24.1	20	MW
Saturated power gain	52	54	dB
Saturated efficiency	82	70	%
Length of RF circuit	900	1500	mm

Novel design Two-Stage (TS) Multi-Beam Klystron (MBK)

It has more power per klystron compared to PIP baseline: **20 MW -> 24 MW**  
Significant **cost** impact

It has higher Efficiency compared to PIP baseline: **70 % -> 82 %**  
Significant impact on **power consumption**

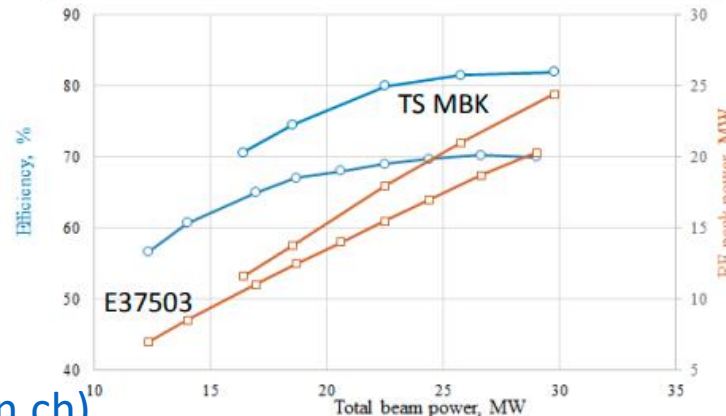

# Step 1: Scaling AS from 20 to 24 MW

RF acc. structure (AS) parameters for CLIC 380	PIP 20 MW MBK	New 24MW TS-MBK
Beam current	4.2	4.2
active length	2.3	2.5
Peak input power for Full Beam Loading (FBL)	18	21.5
Unloaded acc. Voltage	7.92	9.45
Loaded acc. voltage	4.08	4.875
Loaded acc gradient	1.77	1.94
RF-to-beam Efficiency	95	95
<b>Linac parameters</b>		
Number of AS in DBL1	62	52
Number of AS in DBL2	398	333
Total number of AS (klystron, modulators)	460	385
Total number of quads	204	172

Nominal AS input power for FBL is lower than klystron power due to margins:

- WG losses: **5%**
- Power margin for bunching (off crest operation): **3%**
- Power margin for operation and availability: **5%**
- All together **~10%** less power available for FBL acceleration

More power per klystron, modulator, AS unit => less AS, less quads (TBC by BD)

## Step 2: applying higher efficiency 70 -> 82%

- 70% -> **82%** is straightforward to do
- However, it should be noted that there are several other efficiencies at similar level:
- WG losses: 5% -> Efficiency : **95%**
- Modulator CW efficiency: **94%**
- Modulator Pulse efficiency: **88%**
- AS RF-to-beam efficiency: **95%**
- So, there is a limit to which point it make sense to push the klystron efficiency. Maybe we are there !

# Comparison: 20MW MBK vs 24MW TS-MBK

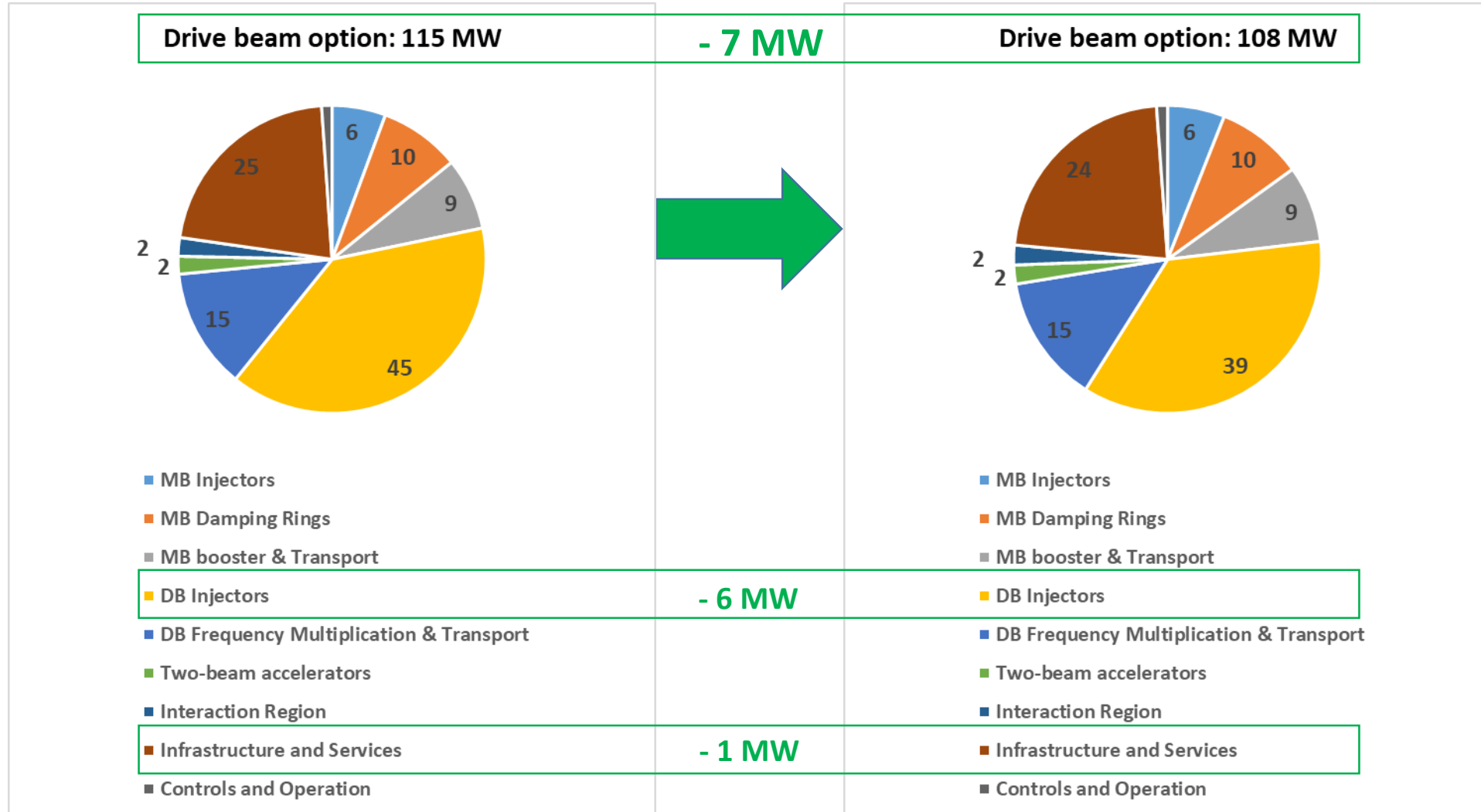



# Comparison of wall plug to beam efficiencies

	PIP baseline	New DR	New TS MBK
DR wall plug to MB efficiency [%]	7.9	56.7	56.7
DB klystron efficiency [%]	70	70	82
DB complex Wall plug to DB efficiency [%]	32.3	32.3	36.1
CLIC Wall plug to MB efficiency [%]	3.4	4.9	5.2

# Summary

- CLIC 380 GeV power estimate has been updated to include several possible changes
- Increase in repetition rate from 50 to 100 Hz result in increase in power consumption by 67 MW from 165 to 232 MW
- New design of the DRs demonstrates significant reduction of the power consumption by 50 MW from 165 to 115 MW
- New 24MW TS MBK with 82% efficiency results in 7 MW reduction in CLIC power consumption