



Exercise: Simple sources and preprocessor

Exercise objectives

- Setting up different simple beams
 - Point source with **BEAM** and **BEAMPOS** card
- Using conditional preprocessor
- Using separate runs
- Visualising the beams
- Plotting the predefined scorings

Problem description

- Start from the provided input
- We want to run a simulation for radiation therapy (the geometry is provided)
- The beams should start in the gantry
($x = 22.5$, $y = 38.97114317$, $z = 0.0$)
and be directed towards the origin $(0,0,0)$
- The following scorings are already included:
 - Side view of the beam
 - Shape of the beam close to the patient
 - Beam energy spectrum

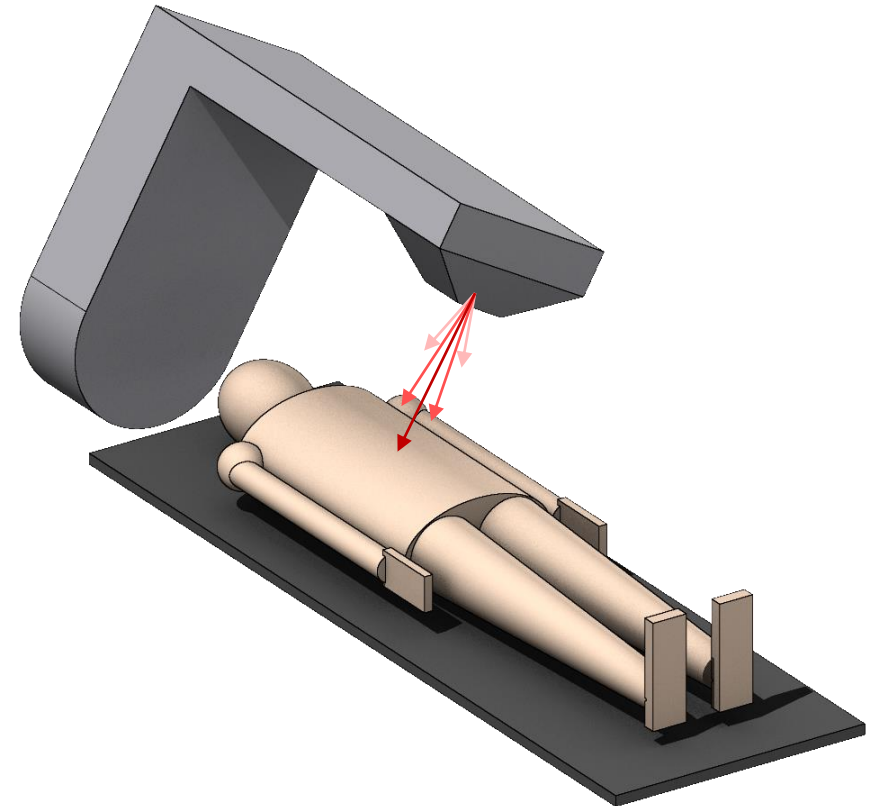

Defining and selecting a beam

- Set up two different photon beams with a flat 0.3 rad angular divergence but different momentum distributions:
 1. Flat momentum distribution between 5 and 10 MeV/c
 2. Gaussian momentum distribution: Mean energy = 10 MeV, FWHM = 1 MeV/c
- Define (**#define**) an identifier named “**Gaussian**”
- Make the two beams selectable using conditional preprocessor directives (**#if**, **#else** and **#endif**)
 - Make sure that if the “**Gaussian**” identifier is enabled, the corresponding Gaussian beam is used

Visualising the beam

- Use the Geometry tab (Geoviewer) to see if the direction and angular divergence are correct
 - Set the scale property to 5000 to be able to see the beam

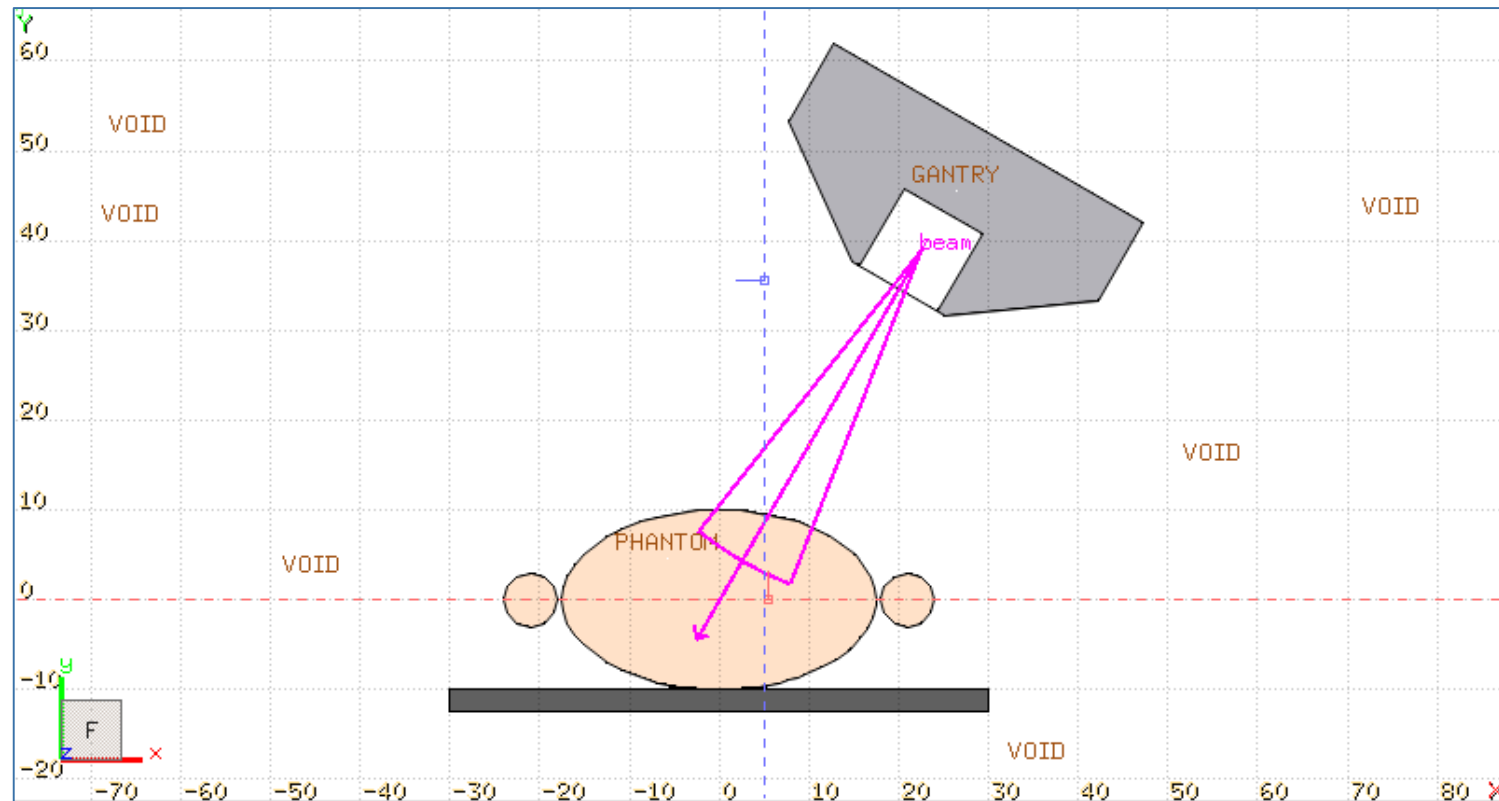

Creating separate runs (in the Run tab)

- Create two new runs called “**Gaussian**” and “**Flat**” in the Run tab

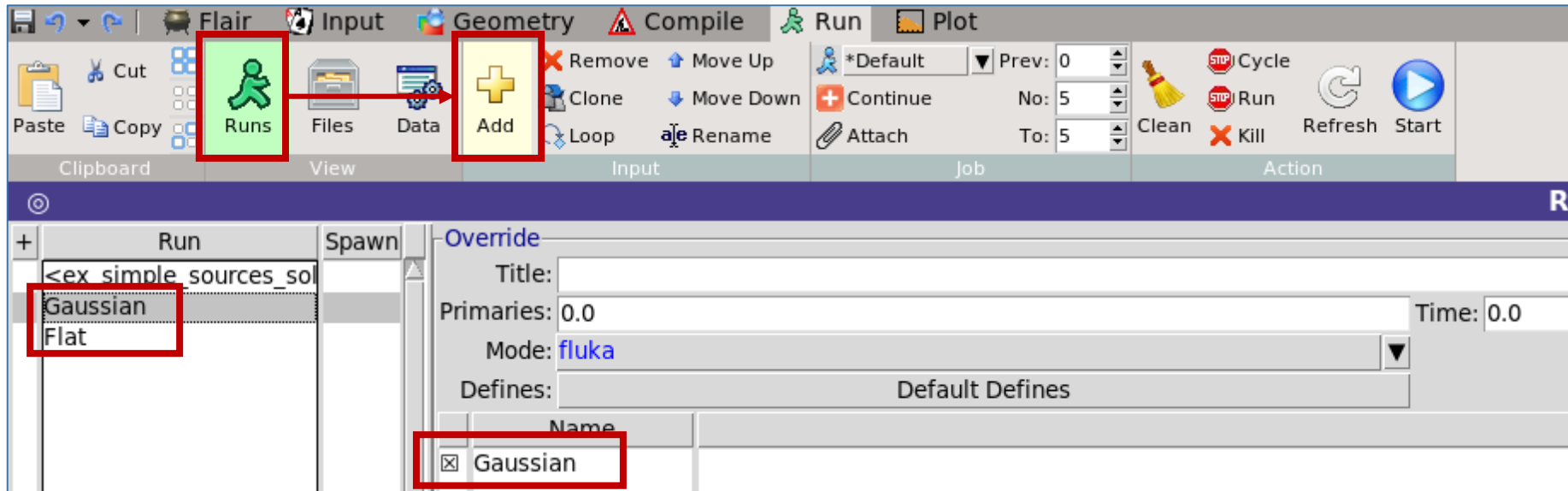

- You can enable or disable an identifier without changing it in the Input tab.
- If the box is checked then the identifier will be enabled, if it is unchecked the identifier will be disabled for the specific run
 - **Enable** the Gaussian identifier for the **Gaussian** run
 - **Disable** the Gaussian identifier for the **Flat** run

Run and process the simulations (in the Run tab)

- Run both simulations:
 - Select the name of the run and click **Start** on the Ribbon

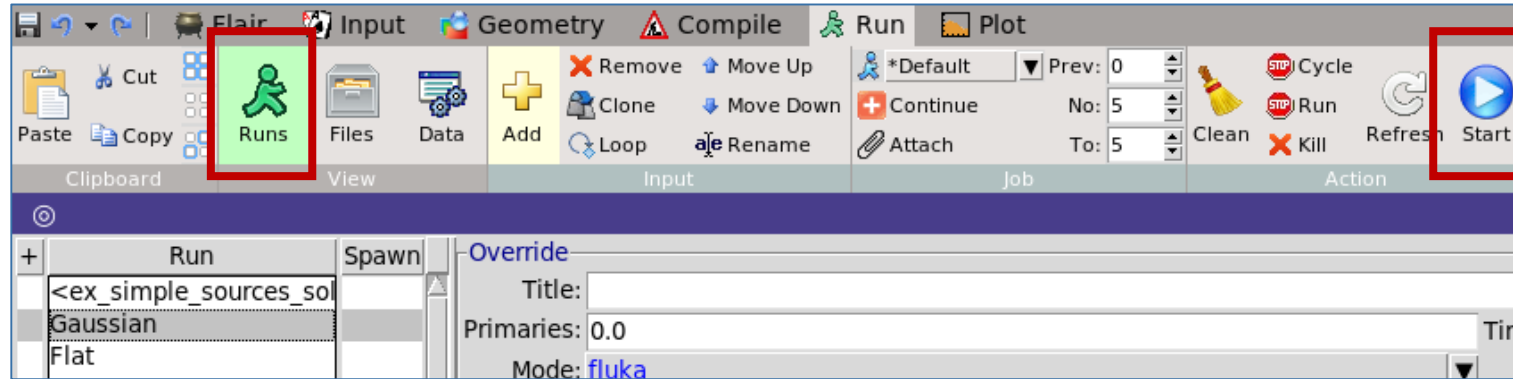

- Process both simulations after the runs are complete:
 - Click **Data** on the Ribbon, select the name of the run and click **Process** on the Ribbon

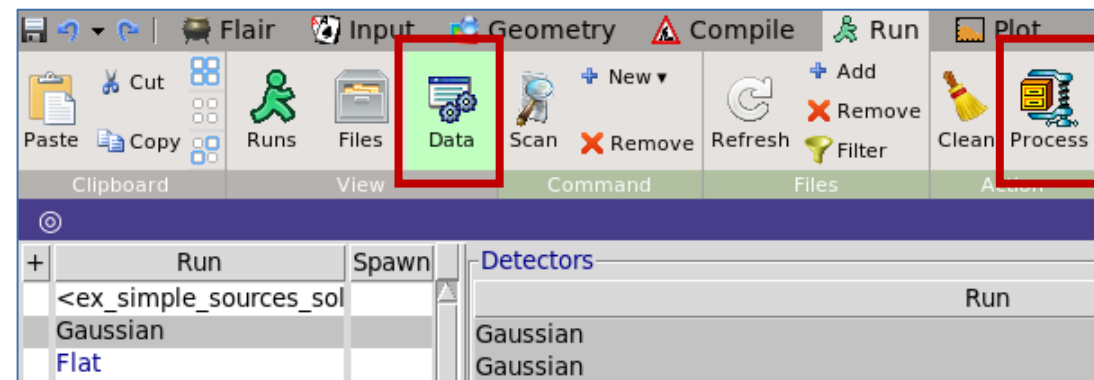

Plot the results

- 4 plots are already prepared:
 - Side profile of the beam
 - Spot shape of the beam
 - Energy spectrum of the Gaussian beam
 - Energy spectrum of the Flat beam

- To plot (in the Plot tab), select the name of a plot on the left side, then click the **Plot** button on the Ribbon

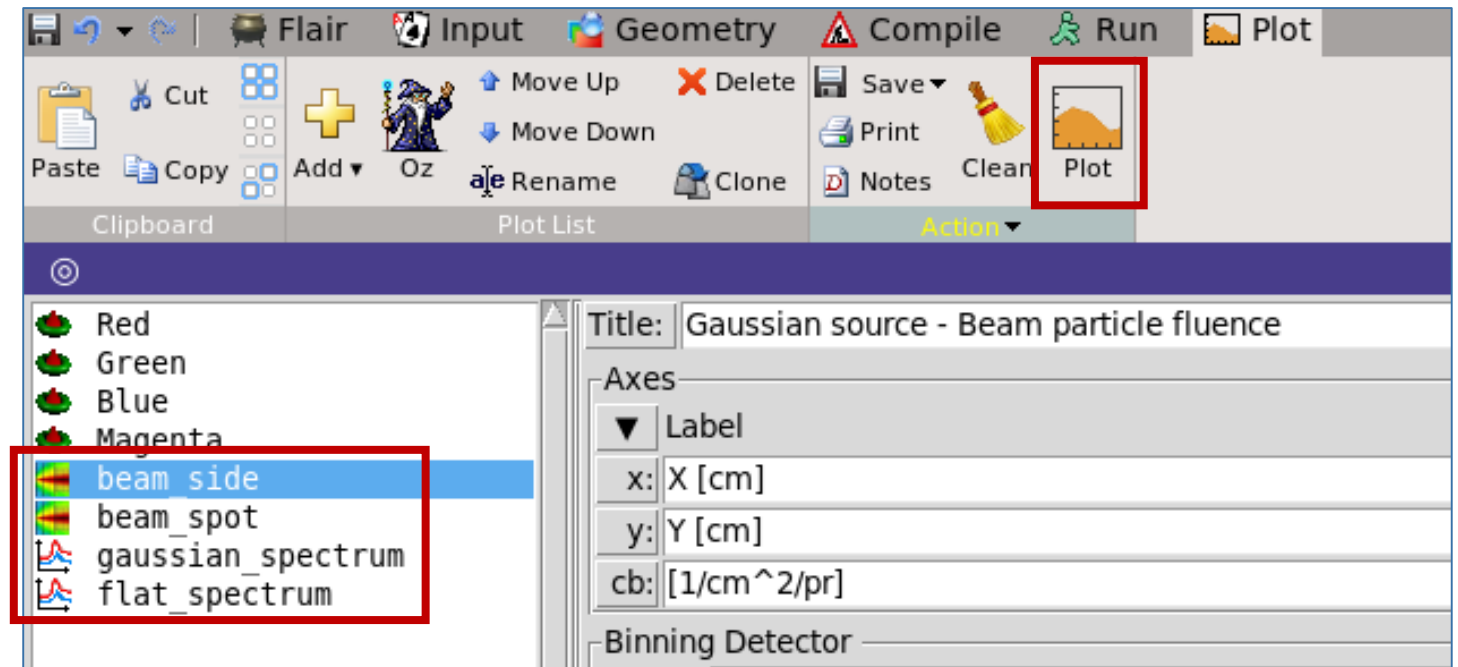

Expected results

beam_side

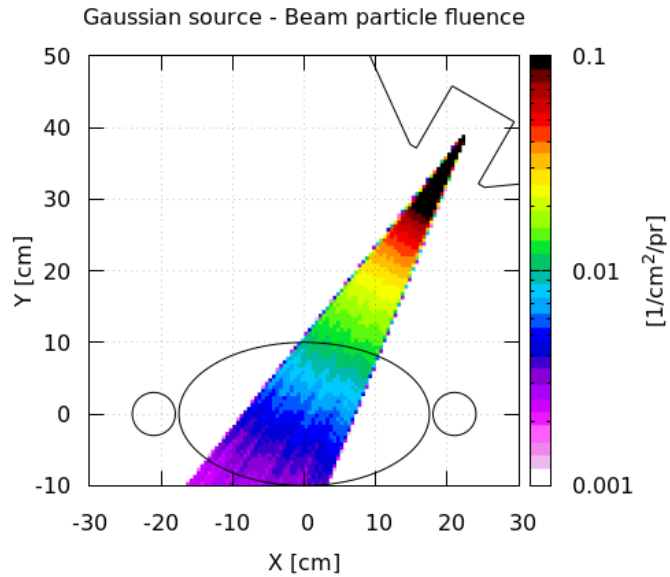

beam_spot

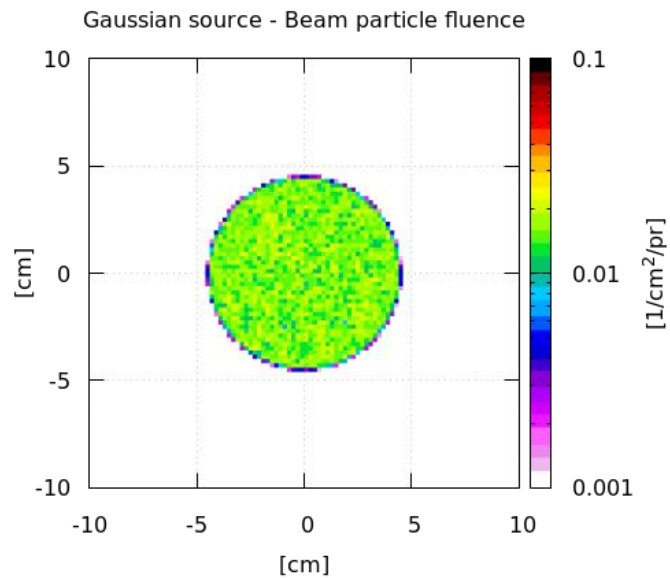

Gaussian source - Energy spectrum

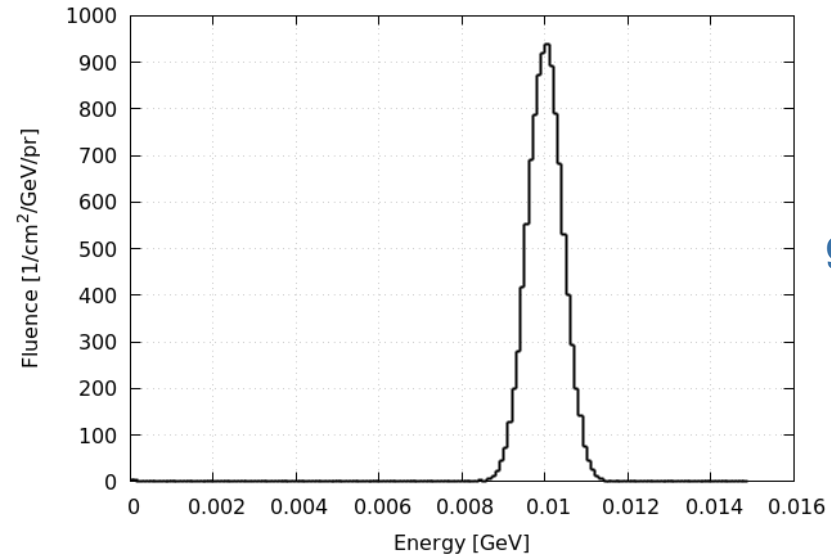

gaussian_spectrum

Flat source - Energy spectrum

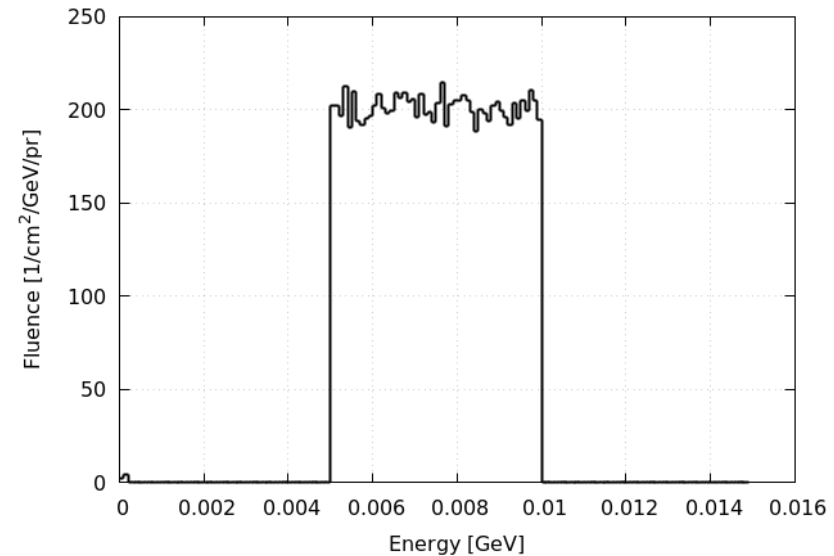

flat_spectrum

