

Caltech

# Dark(**Color**)Unification

A UV-complete theory for Asymmetric Dark Matter

Clara Murgui

In collaboration with Kathryn M. Zurek (Caltech)

June 9th 2022

PPC St. Louis

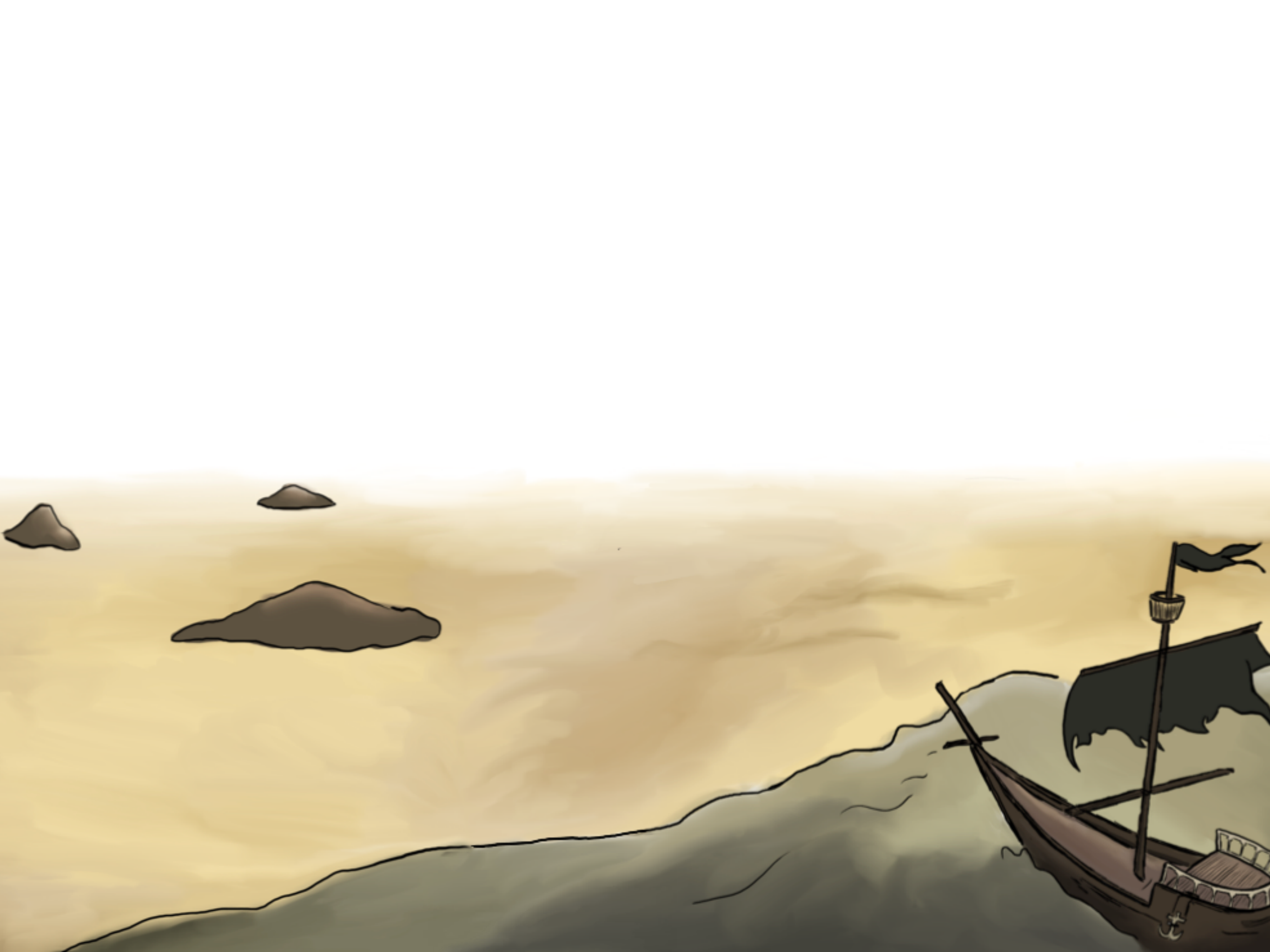

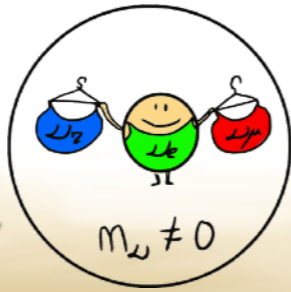
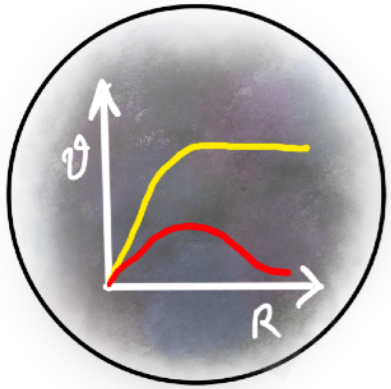

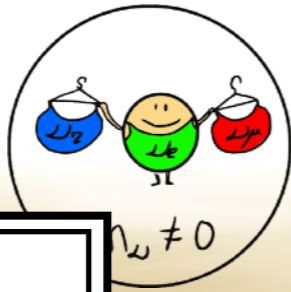
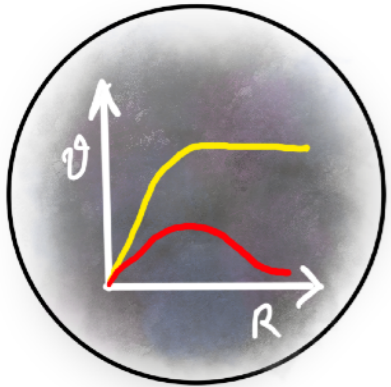

Insert  
Photo  
Here





# Just a coincidence?

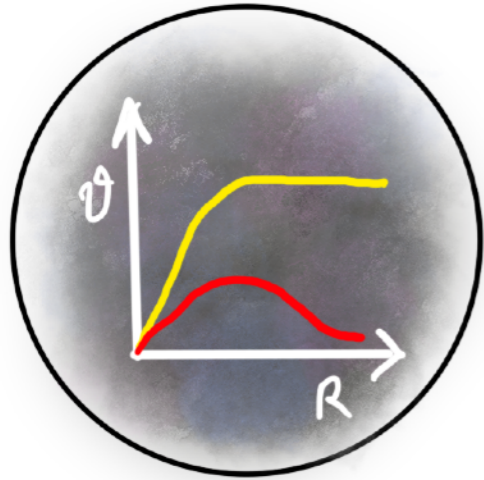

$$\frac{\Omega_{\text{DM}}}{\Omega_B} = \frac{m_{\text{DM}} Y_{\text{DM}}}{m_p Y_B} \sim 5$$

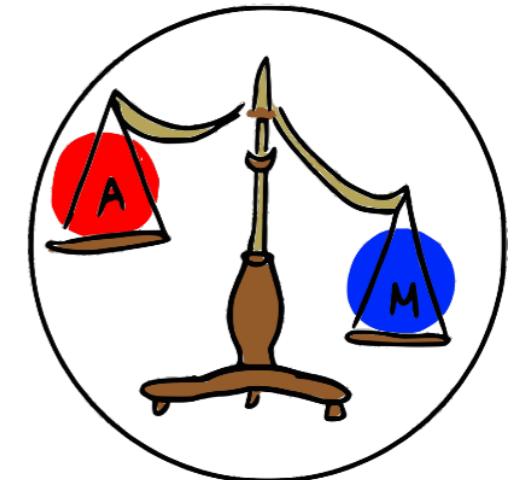

# Just a coincidence?

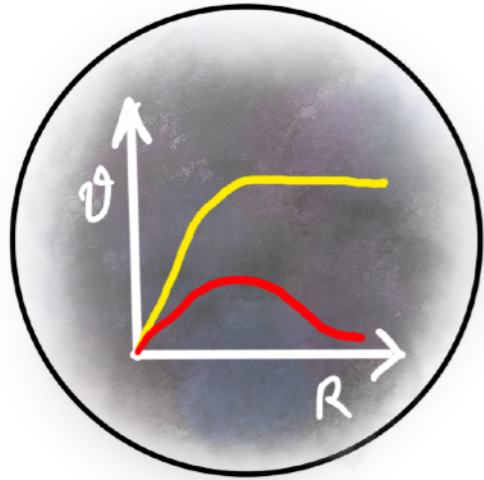

$$\frac{\Omega_{\text{DM}}}{\Omega_B} = \frac{m_{\text{DM}} Y_{\text{DM}}}{m_p Y_B} \sim 5$$

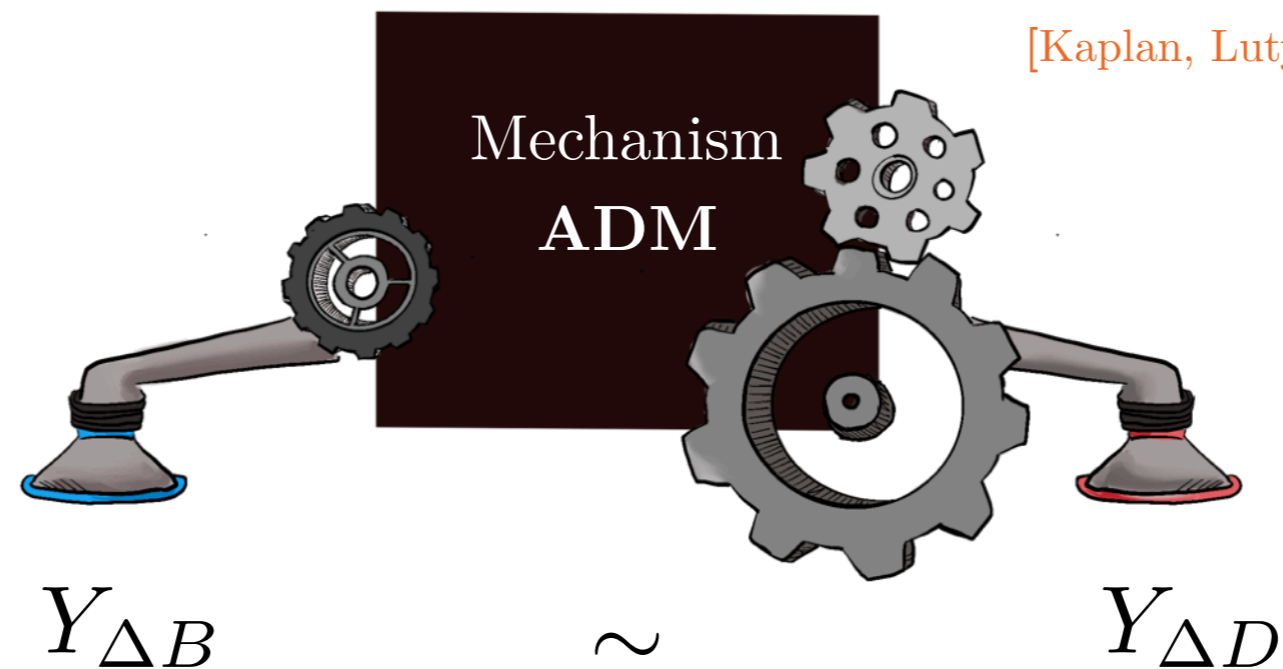
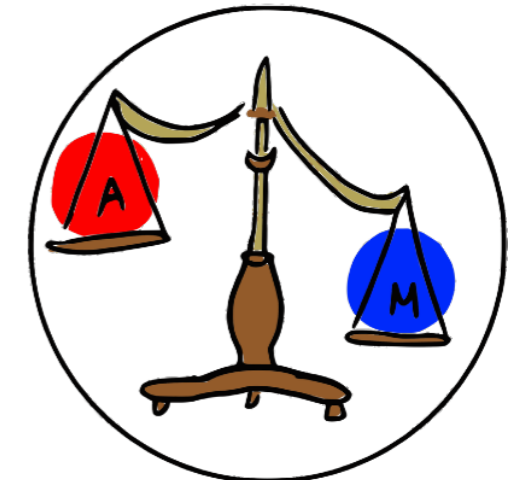

# Just a coincidence?

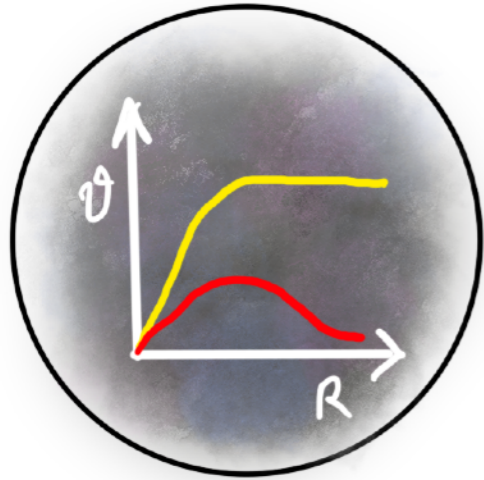

$$\frac{\Omega_{\text{DM}}}{\Omega_B} = \frac{m_{\text{DM}} Y_{\text{DM}}}{m_p Y_B} \sim 5$$

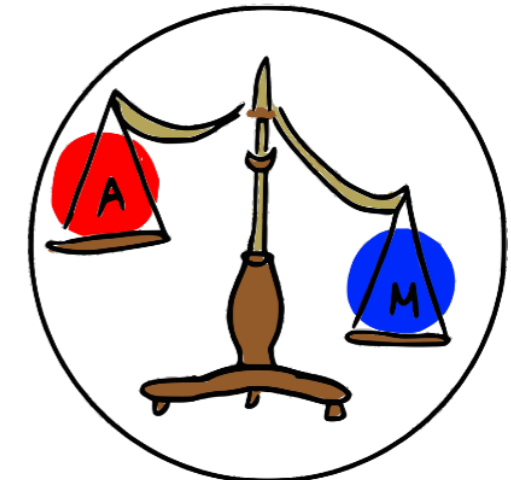

[Kaplan, Luty, Zurek, 2009]

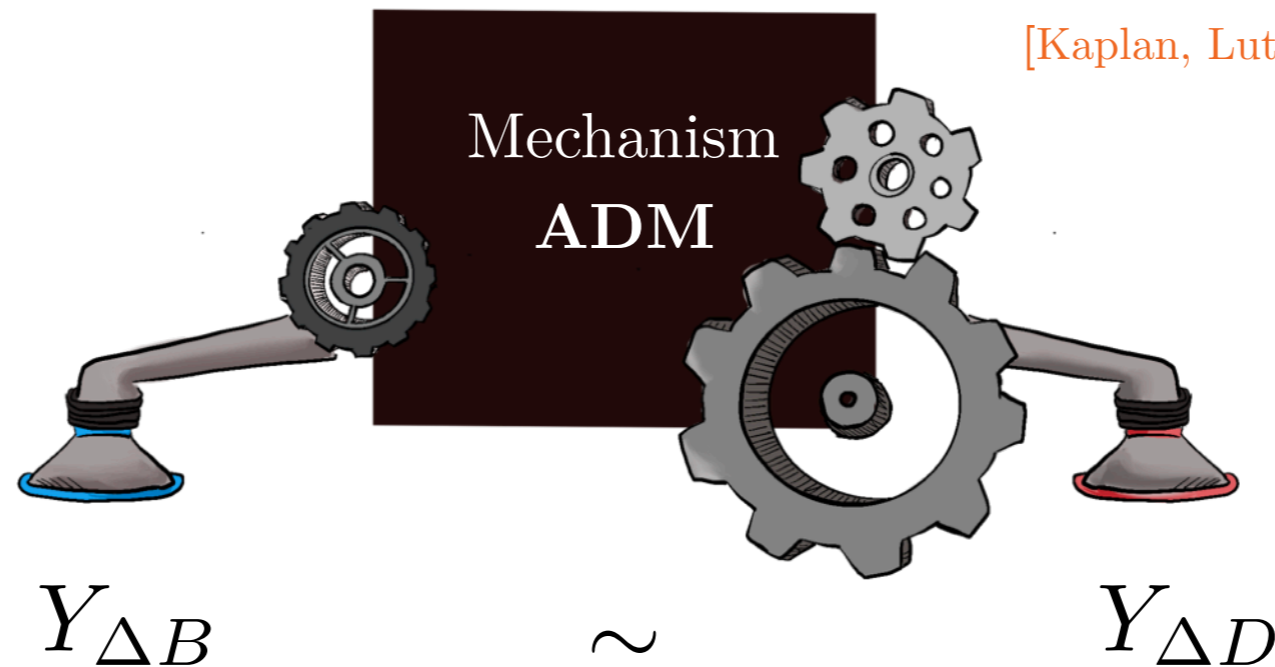

$$\Rightarrow m_{\text{DM}} \sim \mathcal{O}(1) m_p$$



# Just a coincidence?

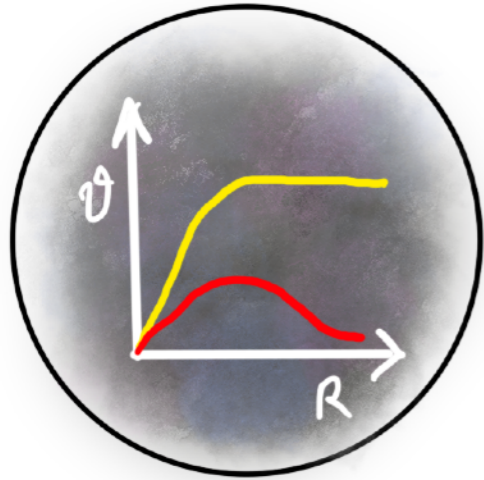

$$\frac{\Omega_{\text{DM}}}{\Omega_B} = \frac{m_{\text{DM}} Y_{\text{DM}}}{m_p Y_B} \sim 5$$

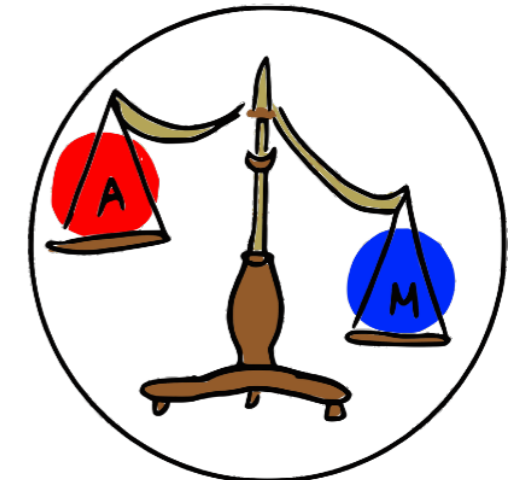

[Foot, Volkas, 2003]

[Foot, Volkas, 2004]

[Lonsdale, Volkas, 2014]

[Lonsdale, 2015]

[Lonsdale, Volkas, 2019]

[Kaplan, Luty, Zurek, 2009]

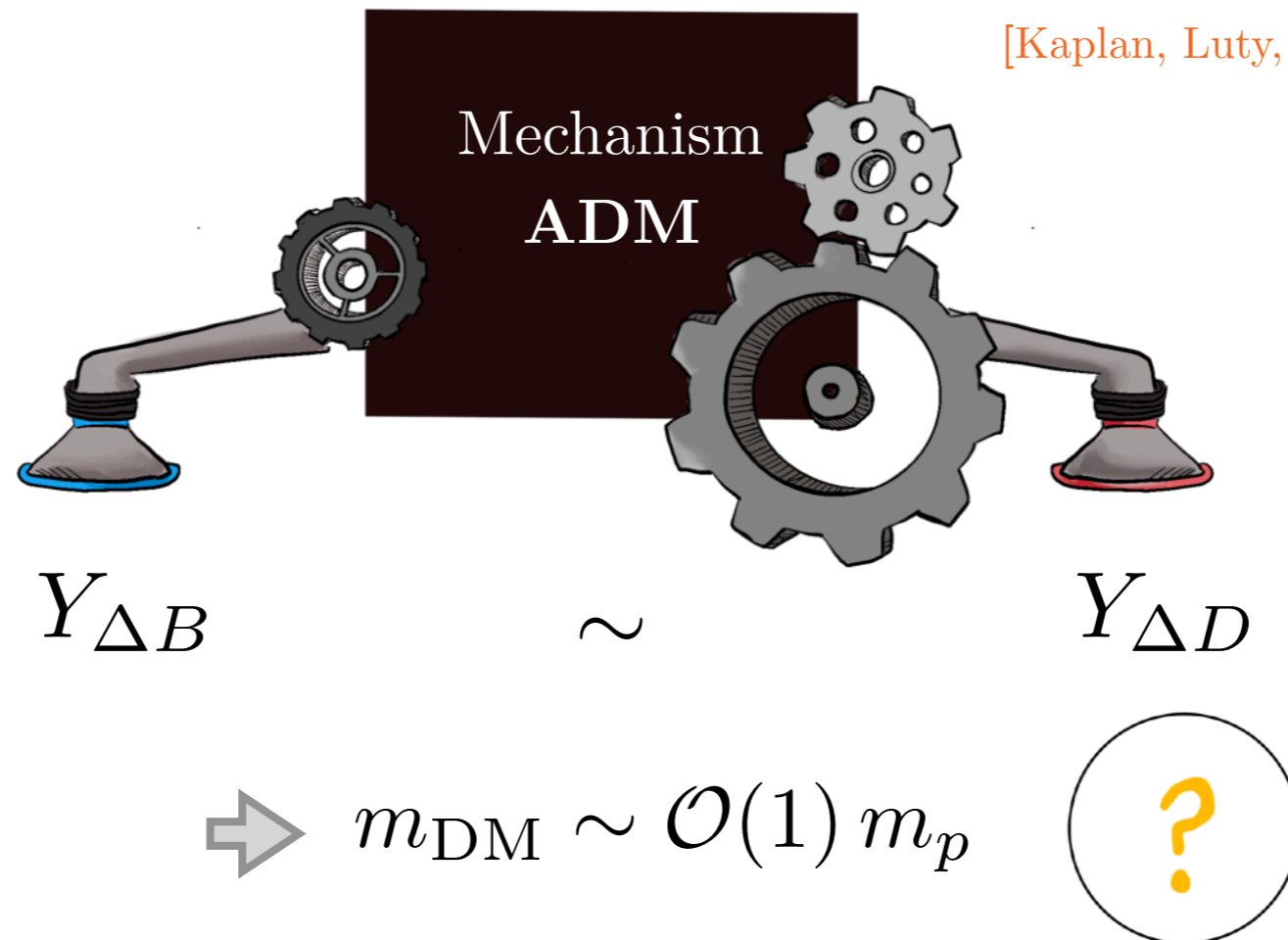



# Just a coincidence?

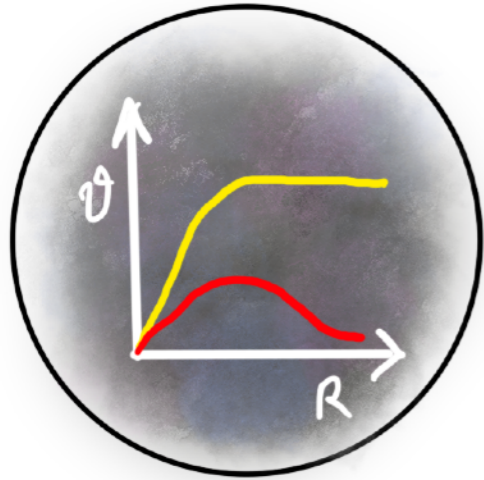

$$\frac{\Omega_{\text{DM}}}{\Omega_B} = \frac{m_{\text{DM}} Y_{\text{DM}}}{m_p Y_B} \sim 5$$

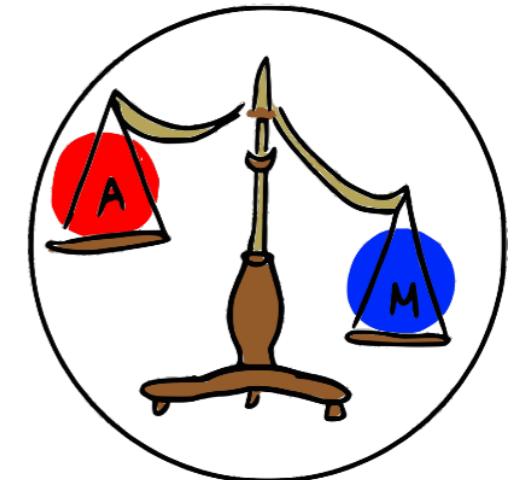

[Kaplan, Luty, Zurek, 2009]

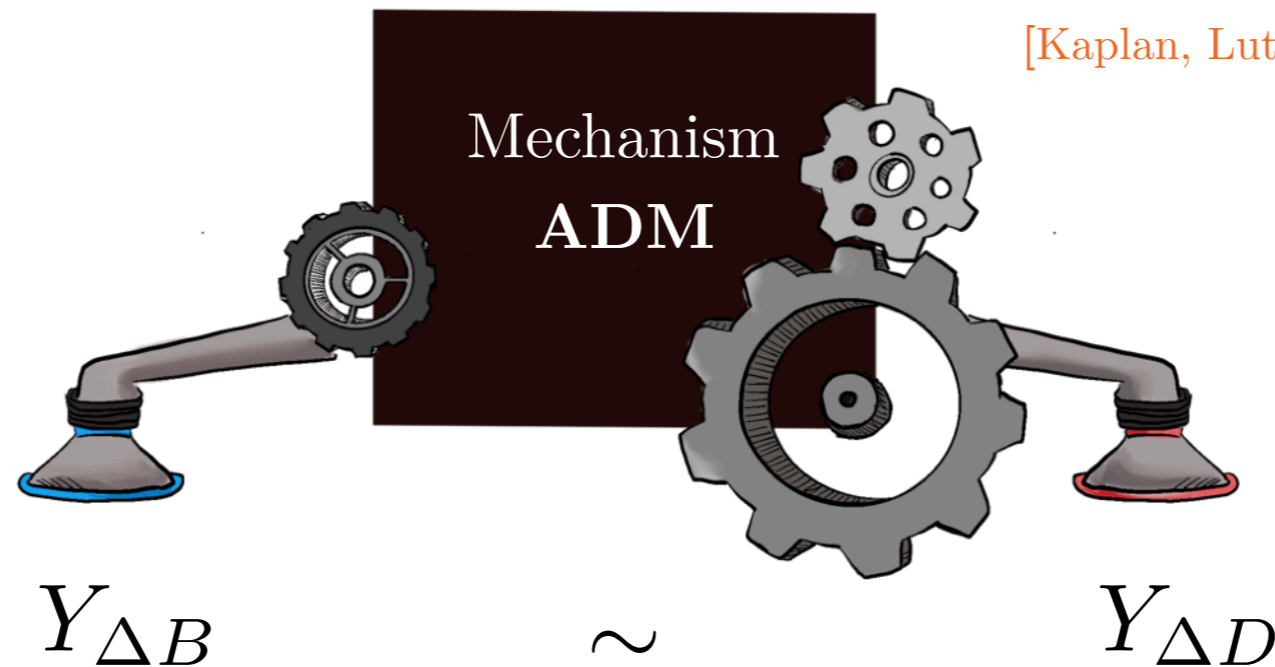

[Foot, Volkas, 2003]

[Foot, Volkas, 2004]

[Lonsdale, Volkas, 2014]

[Lonsdale, 2015]

[Lonsdale, Volkas, 2019]

[Cohen, Phalen, Pierce, Zurek, 2010]

$$\Rightarrow m_{\text{DM}} \sim \mathcal{O}(1) m_p$$



# The idea: DarkUnification

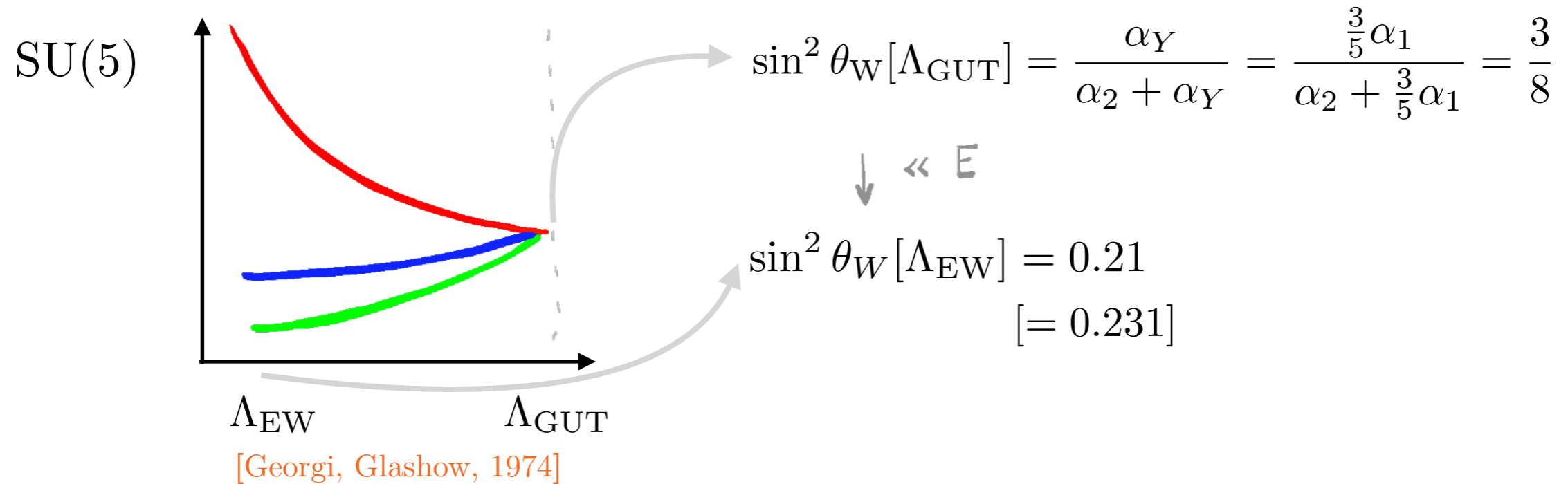

# The idea: DarkUnification

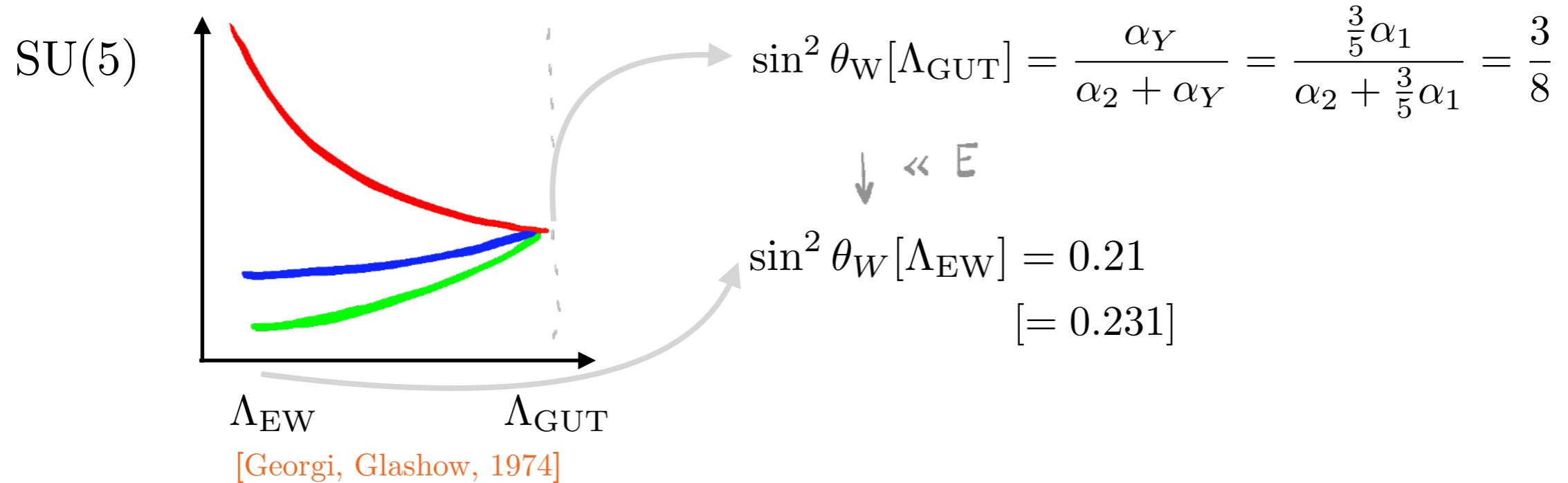

- 1 Pick subjects of similar nature

# The idea: DarkUnification

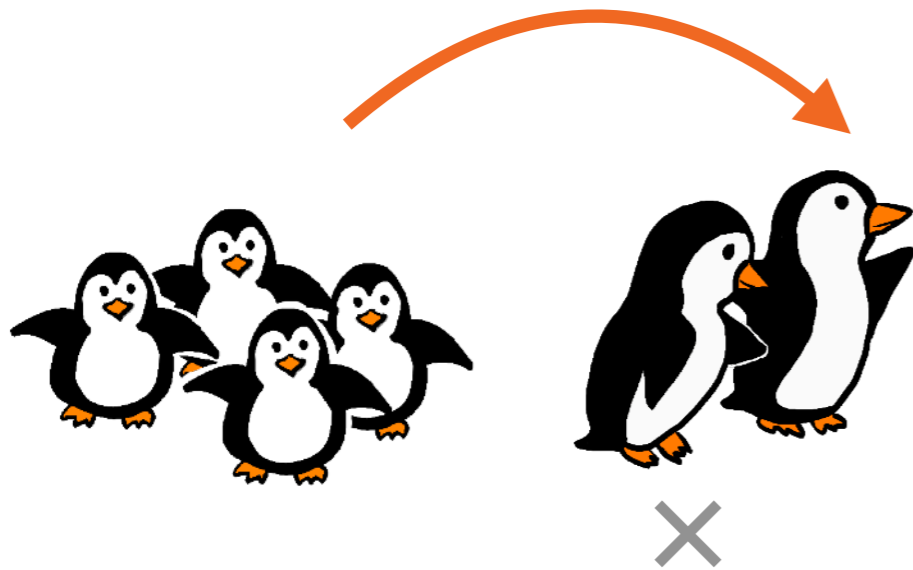
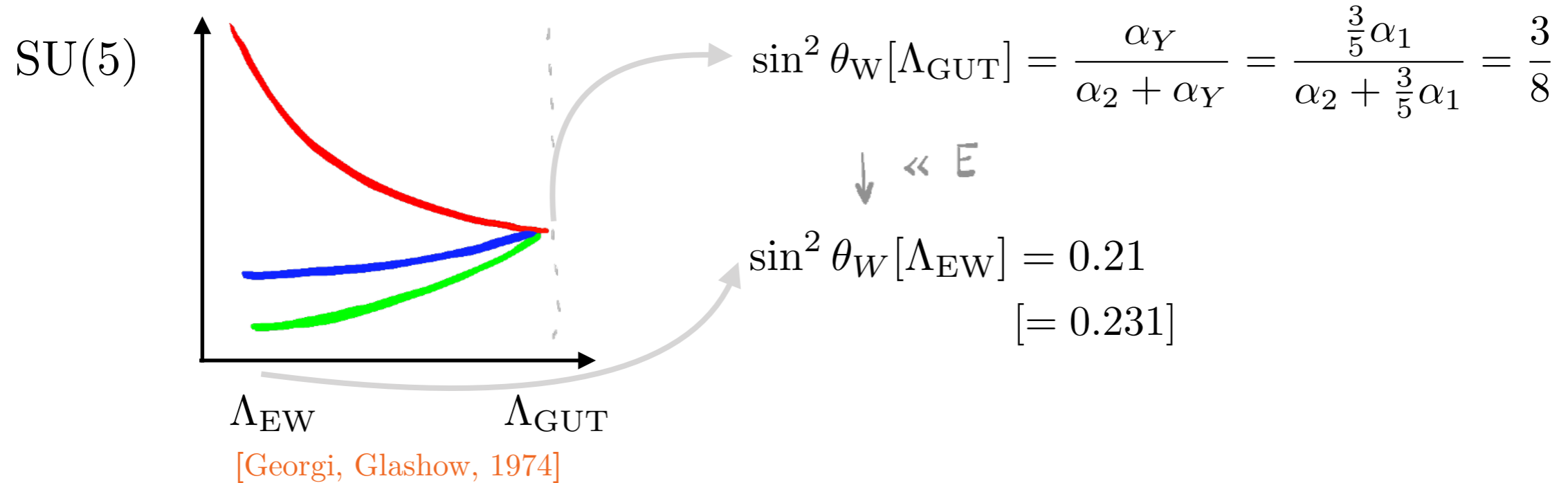

**1** Pick subjects of similar nature

**2** Common starting point



# The idea: DarkUnification

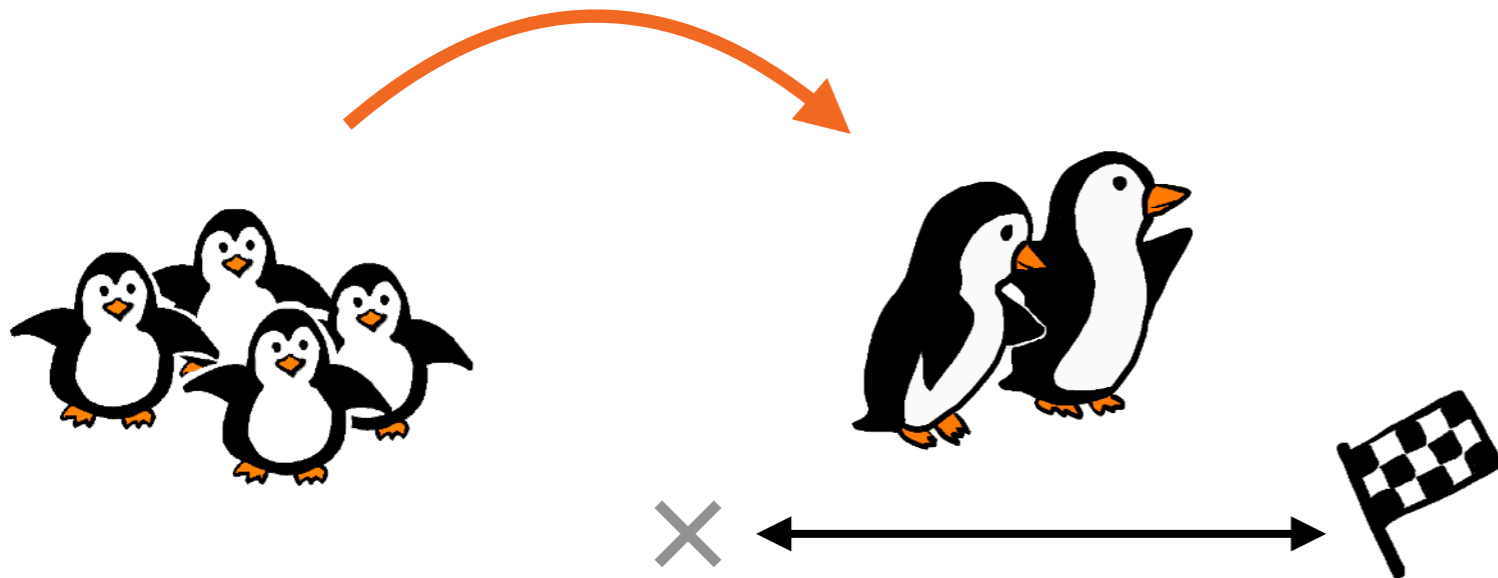
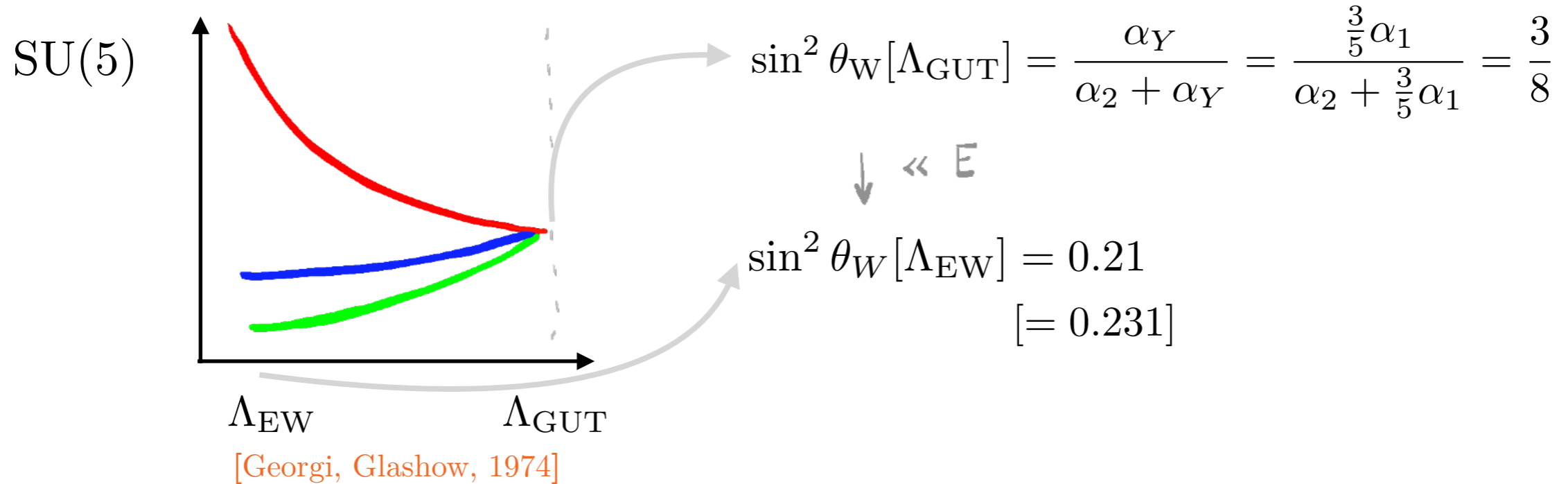

**1** Pick subjects of similar nature

**2** Common starting point

**3** Don't let them run too much and...

# The idea: DarkUnification

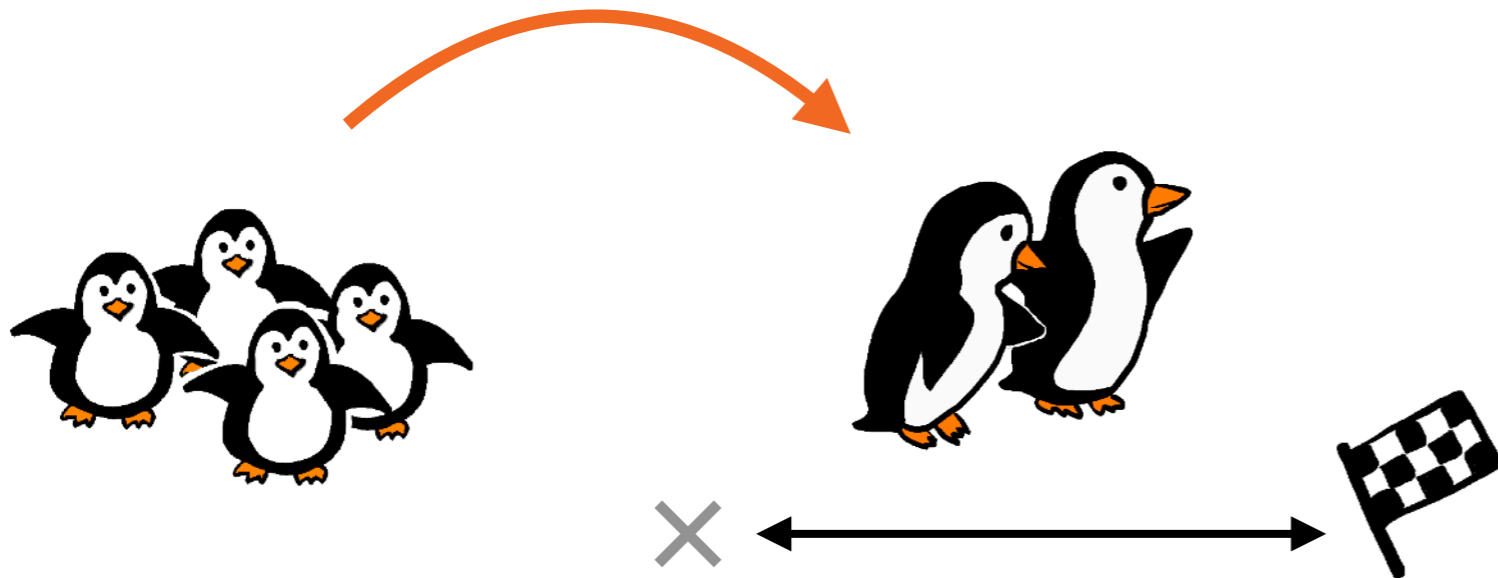
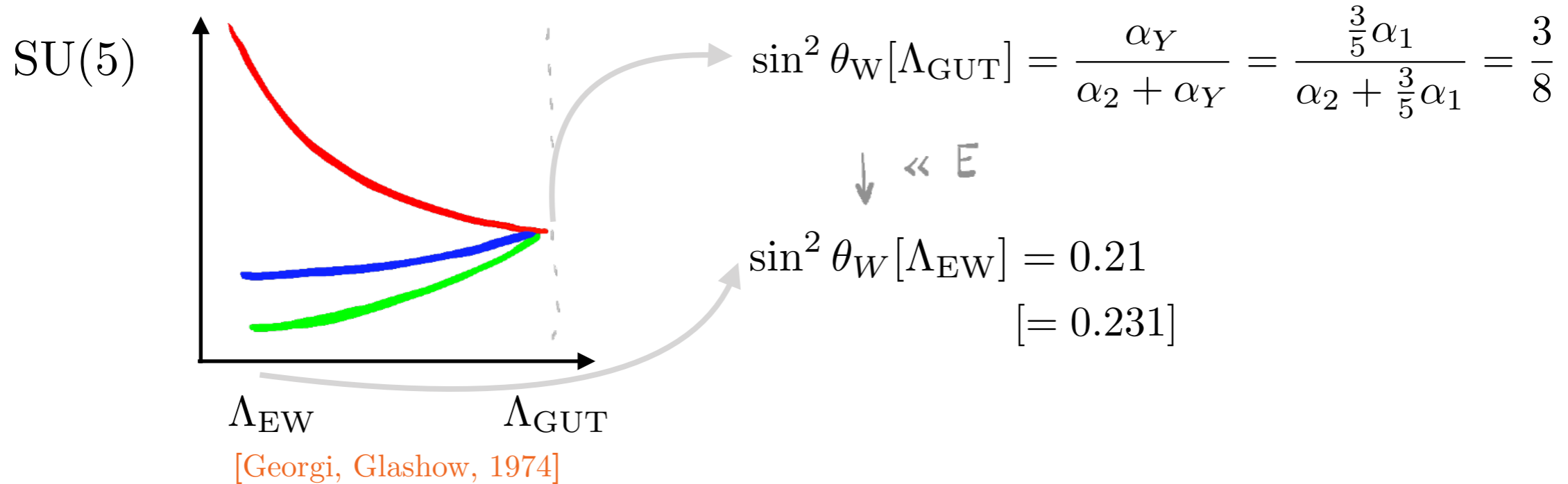

- 1** Pick subjects of similar nature
- 2** Common starting point
- 3** Don't let them run too much and...

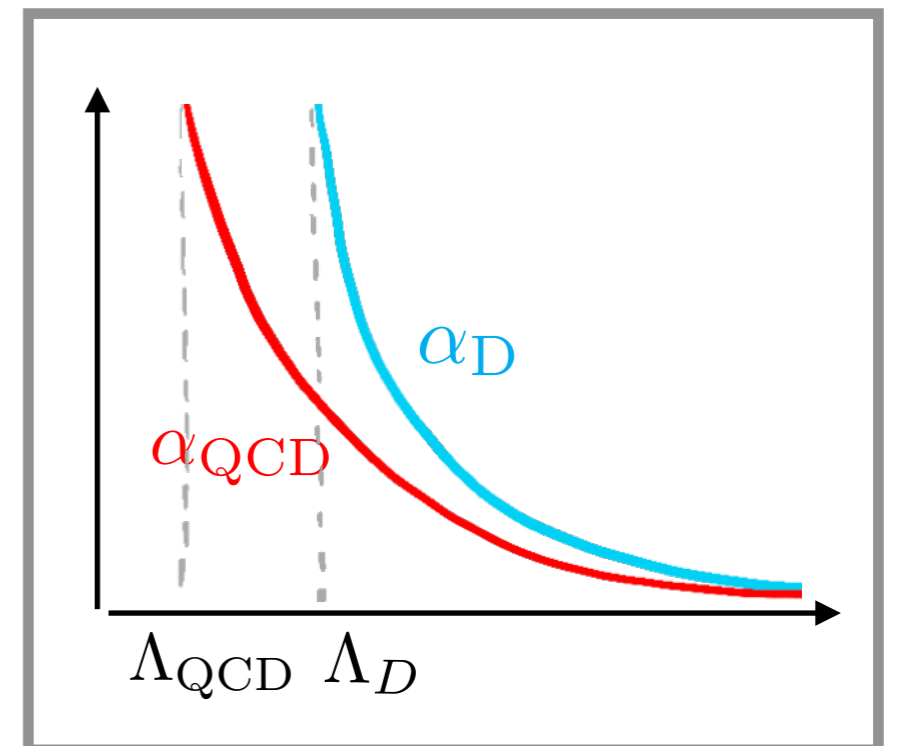

# The framework



# Hyper-Color

$$SU(N) \rightarrow SU(3)_C \otimes SU(N - 3)_D \otimes U(1)_N$$

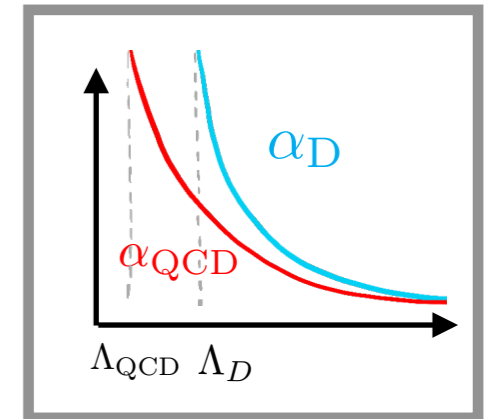

➔ Gauge group:

$$SU(N) \otimes SU(2)_L \otimes U(1)_X$$





# Hyper-Color

$$SU(N) \rightarrow SU(3)_C \otimes SU(N-3)_D \otimes U(1)_N$$

$N$  odd (Witten anomaly)

$$N_Q \sim (N, 2, \#_Q)$$

$$\bar{N}_{u^c} \sim (\bar{N}, 1, \#_{u^c})$$

$$\bar{N}_{d^c} \sim (\bar{N}, 1, \#_{d^c})$$

$$L \sim (1, 2, \frac{1}{2})$$

$$e^c \sim (1, 1, 1)$$

➔ Gauge group:

$$SU(N) \otimes SU(2)_L \otimes U(1)_X$$

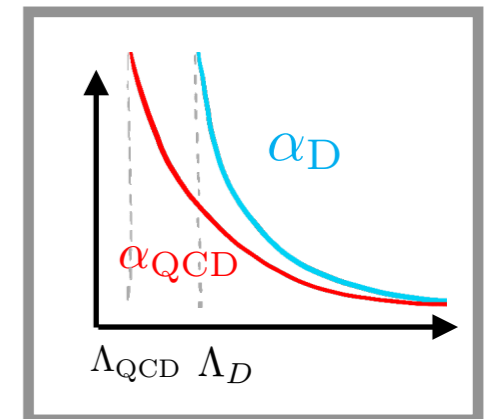

# Hyper-Color

$$SU(N) \rightarrow SU(3)_C \otimes SU(N-3)_D \otimes U(1)_N$$

$N$  odd (Witten anomaly)

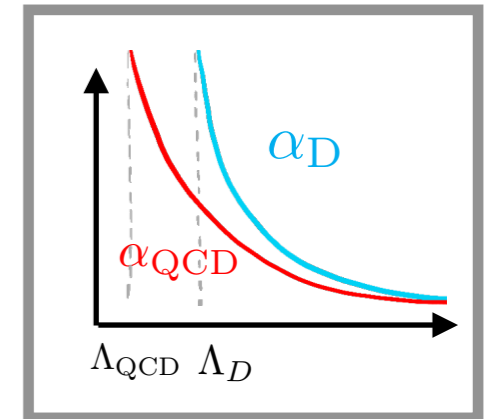

$$N_Q \sim (N, 2, \frac{1}{2N})$$

$$\bar{N}_{u^c} \sim (\bar{N}, 1, -\frac{N+1}{2N})$$

$$\bar{N}_{d^c} \sim (\bar{N}, 1, \frac{N-1}{2N})$$

$$T_{N^2-1} = \frac{1}{\#} \text{diag}(1, 1, 1, -3/N, \dots, -3/N)$$

$$L \sim (1, 2, \frac{1}{2})$$

$$e^c \sim (1, 1, 1)$$

gravity anomaly

$$\propto \underbrace{N\#_Q}_Q + \underbrace{\frac{1}{2}}_L$$

$$\Rightarrow \#_Q = 1/(2N)$$

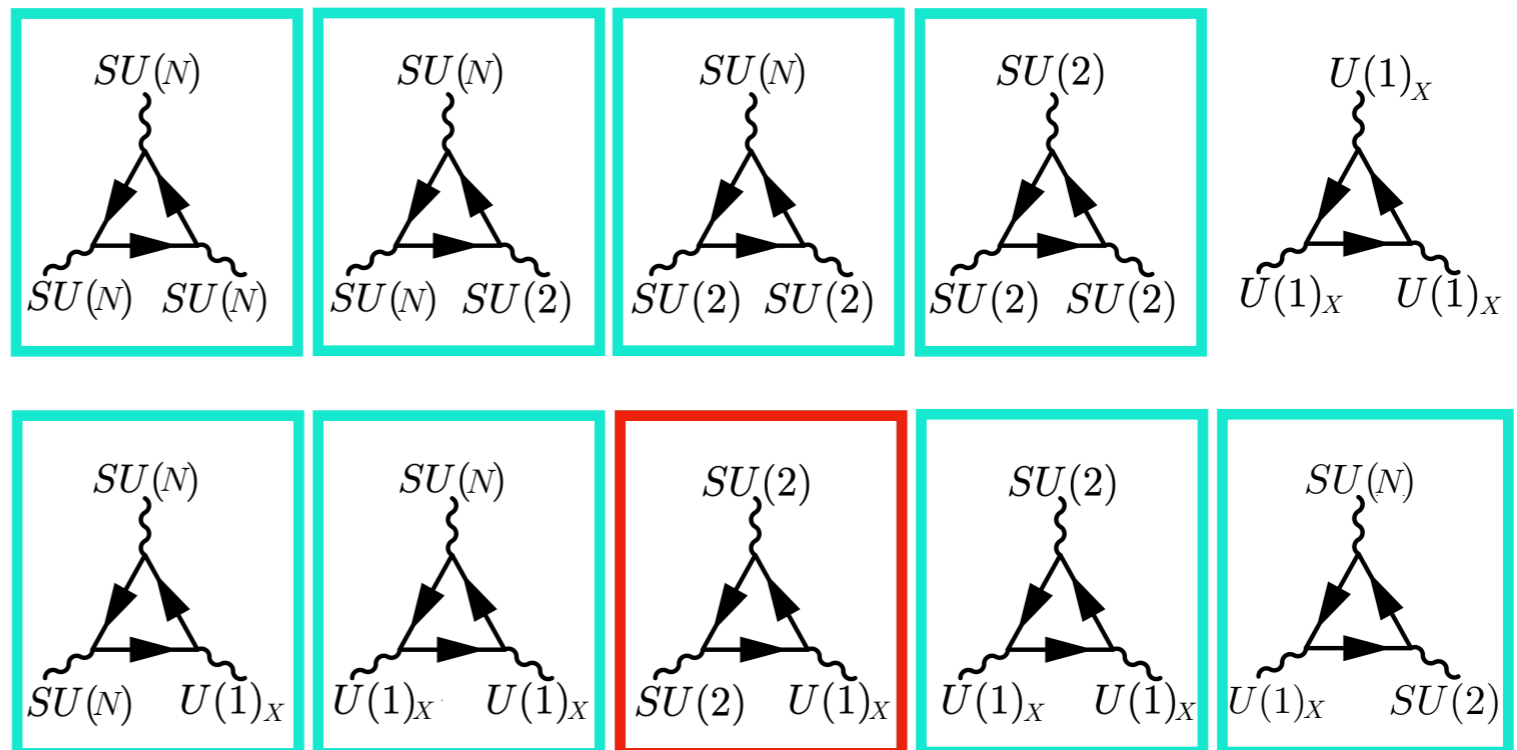

# Hyper-Color

$$SU(N) \rightarrow SU(3)_C \otimes SU(N-3)_D \otimes U(1)_N$$

$N$  odd (Witten anomaly)

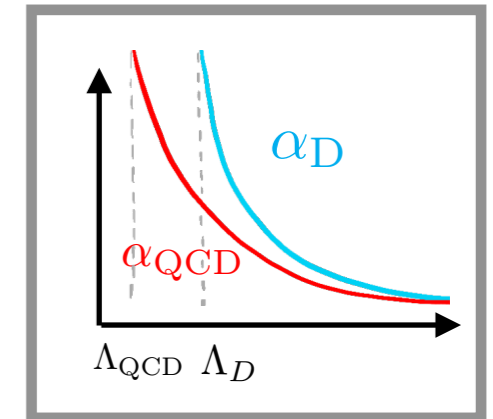

$$N_Q \sim (N, 2, \frac{1}{2N})$$

$$\bar{N}_{u^c} \sim (\bar{N}, 1, -\frac{N+1}{2N})$$

$$\bar{N}_{d^c} \sim (\bar{N}, 1, \frac{N-1}{2N})$$

$$T_{N^2-1} = \frac{1}{\#} \text{diag}(1, 1, 1, -3/N, \dots, -3/N)$$

$$L \sim (1, 2, \frac{1}{2})$$

$$e^c \sim (1, 1, 1)$$

gravity anomaly

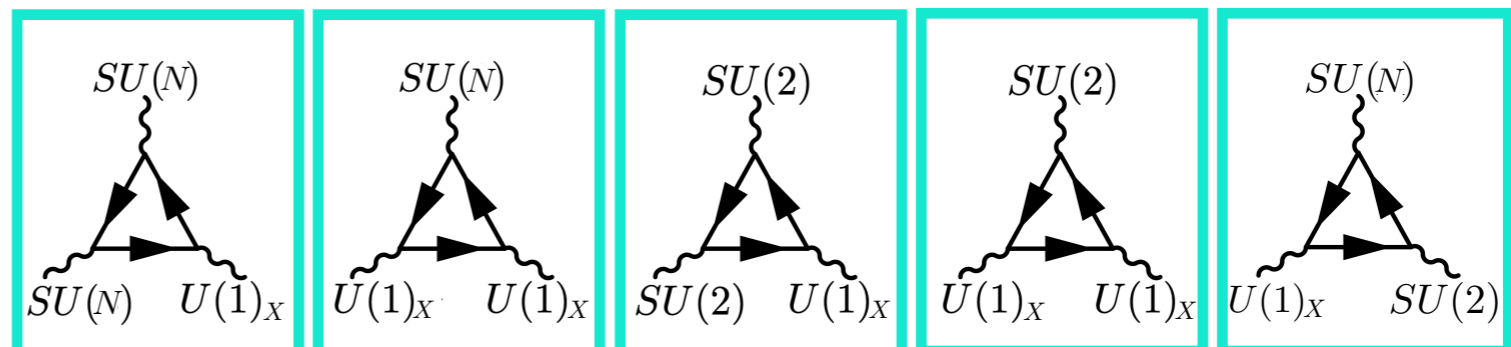
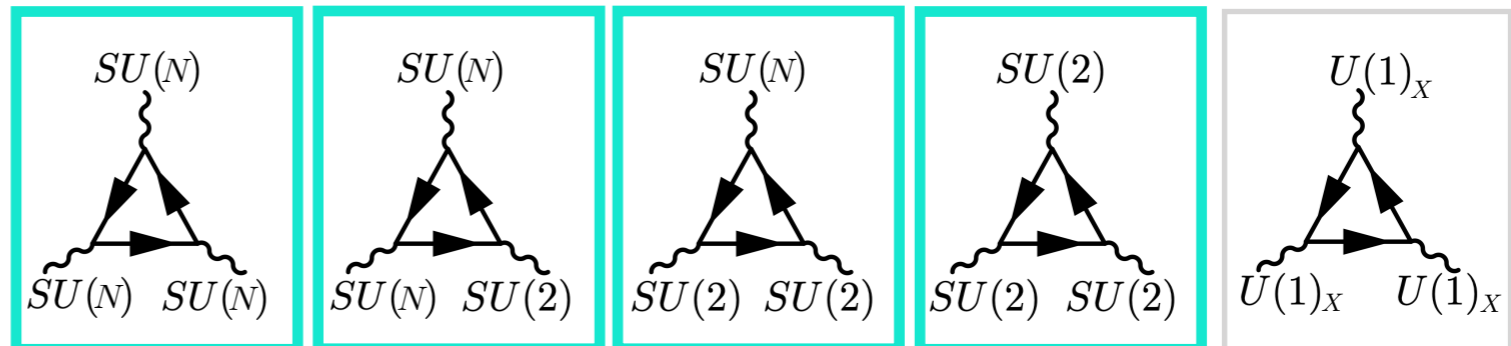

$$\text{In}[4]= \left(\frac{1}{2N}\right)^3 * 2 * N - \left(\frac{N+1}{2N}\right)^3 * N + \left(\frac{N-1}{2N}\right)^3 * N - 2 * \left(\frac{1}{2}\right)^3 + 1^3$$

$$\text{Out}[4]= \frac{(N-1)^3}{8N^2} - \frac{(N+1)^3}{8N^2} + \frac{1}{4N^2} + \frac{3}{4}$$



# Hyper-Color

$$SU(N) \rightarrow SU(3)_C \otimes SU(N-3)_D \otimes U(1)_N$$

$N$  odd (Witten anomaly)

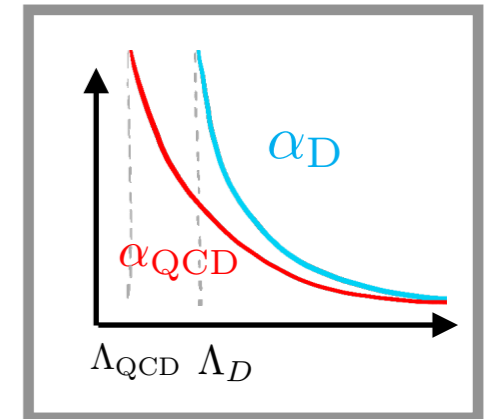

$$N_Q \sim (N, 2, \frac{1}{2N})$$

$$\bar{N}_{u^c} \sim (\bar{N}, 1, -\frac{N+1}{2N})$$

$$\bar{N}_{d^c} \sim (\bar{N}, 1, \frac{N-1}{2N})$$

$$L \sim (1, 2, \frac{1}{2})$$

$$e^c \sim (1, 1, 1)$$

$$T_{N^2-1} = \frac{1}{\#} \text{diag}(1, 1, 1, -3/N, \dots, -3/N)$$

gravity anomaly

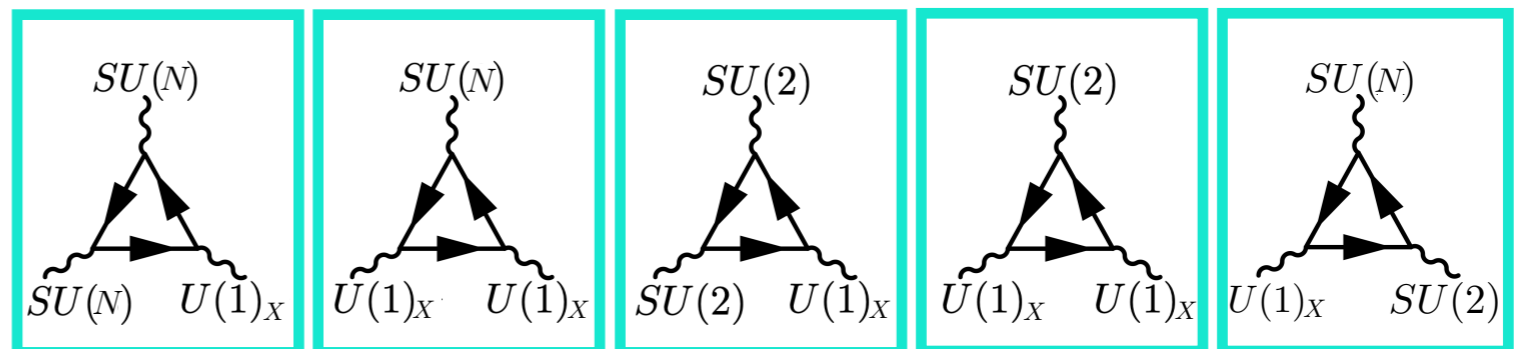
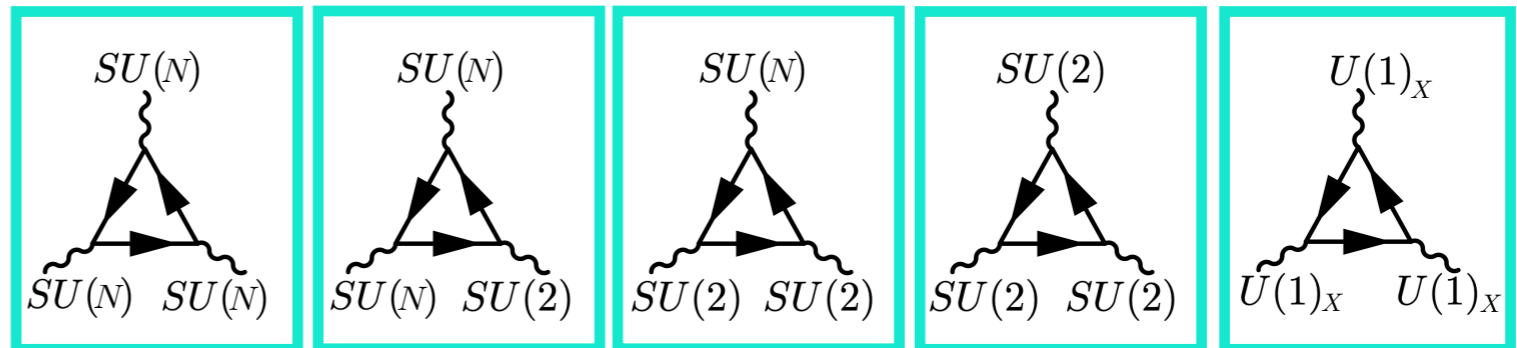

```
In[5]:= (1/(2N))^3 * 2 * N - ((N+1)/(2N))^3 * N + ((N-1)/(2N))^3 * N - 2 * (1/2)^3 + 1^3 //
FullSimplify
```

Out[5]= 0





# Hyper-Color

$$SU(N) \rightarrow SU(3)_C \otimes SU(N-3)_D \otimes U(1)_N$$

$N$  odd (Witten anomaly)

$$N_q \sim (\mathbf{N}, 2, \frac{1}{2N})_{\mathcal{G}_N} \sim \begin{pmatrix} q \\ \Psi \end{pmatrix}$$

$$\bar{N}_u \sim (\bar{\mathbf{N}}, 1, -\frac{N+1}{2N})_{\mathcal{G}_N} \sim \begin{pmatrix} u^c \\ \eta_u \end{pmatrix}$$

$$\bar{N}_d \sim (\bar{\mathbf{N}}, 1, \frac{N+1}{2N})_{\mathcal{G}_N} \sim \begin{pmatrix} d^c \\ \eta_d \end{pmatrix}$$

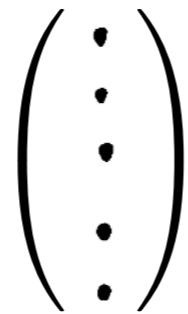

**Quarks**

$SU(3)_C$

$SU(N-3)_D$

**Quirks**

[Kang, Luty, 2008],

[Kribs, Roy, Terning, Zurek, 2009]

just SM leptons

$$\begin{pmatrix} \ell \sim (1, 2, \frac{1}{2}) \\ e^c \sim (1, 1, 1) \end{pmatrix}$$

$$N \sim (1, 1, 0)$$

type-I seesaw



# Hyper-Color

$$SU(N) \rightarrow SU(3)_C \otimes SU(N-3)_D \otimes U(1)_N$$

$N$  odd (Witten anomaly)

$$N_q \sim (\bar{N}, 2, \frac{1}{2N})_{\mathcal{G}_N} \sim \begin{pmatrix} q \\ \Psi \end{pmatrix}$$

$$\bar{N}_u \sim (\bar{N}, 1, -\frac{N+1}{2N})_{\mathcal{G}_N} \sim \begin{pmatrix} u^c \\ \eta_u \end{pmatrix}$$

$$\bar{N}_d \sim (\bar{N}, 1, \frac{N+1}{2N})_{\mathcal{G}_N} \sim \begin{pmatrix} d^c \\ \eta_d \end{pmatrix}$$

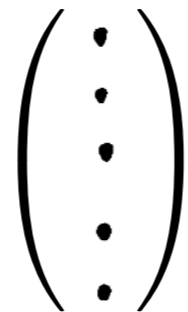

**Quarks**  $SU(3)_C$

**Quirks**  $SU(N-3)_D$

[Kang, Luty, 2008],  
[Kribs, Roy, Terning, Zurek, 2009]

just SM leptons

$$\begin{pmatrix} \ell \sim (1, 2, \frac{1}{2}) \\ e^c \sim (1, 1, 1) \end{pmatrix}$$

$$N \sim (1, 1, 0)$$

type-I seesaw

$$\mathcal{L}_{\text{Yuk}} \supset Y_u N_q H \bar{N}_{u^c} + Y_d N_q H^\dagger \bar{N}_{d^c} + \text{h.c.}$$

$$\xrightarrow{\langle H \rangle} M_u \left( 1 + \frac{h}{v} \right) \boxed{u u^c} + \boxed{\Psi_u \eta_{u^c}} + M_d \left( 1 + \frac{h}{v} \right) \boxed{d d^c} + \boxed{\Psi_d \eta_{d^c}}$$

[See Suchita's talk on Tuesday]



# SU(5) Hyper-Color

$$SU(5) \rightarrow SU(3)_c \otimes SU(2)_D \otimes U(1)_5$$

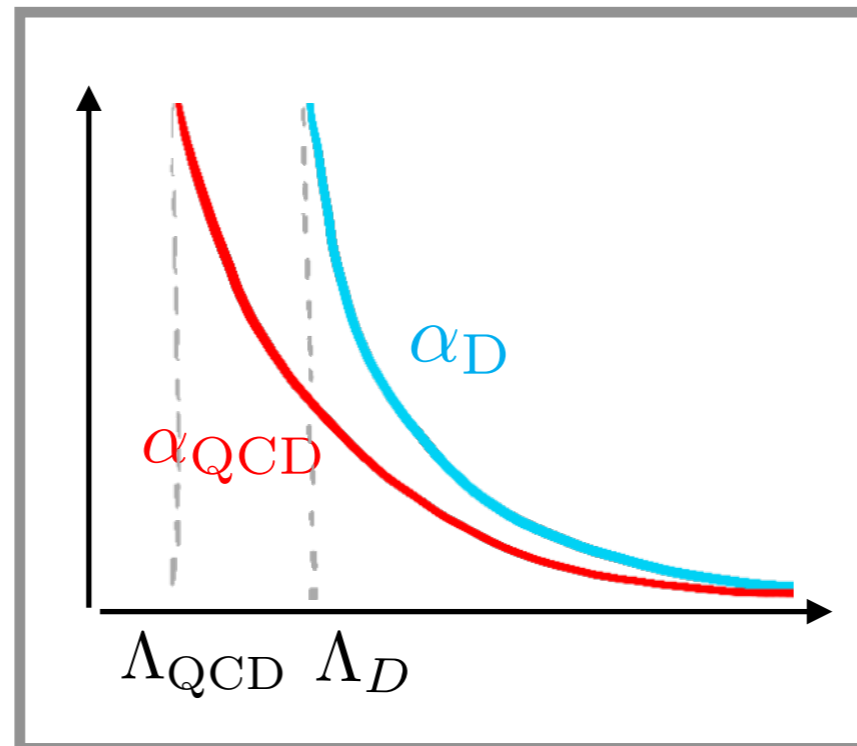

# The simplest gauge group

⇒ Gauge group:

$$SU(5) \otimes SU(2)_L \otimes U(1)_X$$



# The simplest gauge group

⇒ Gauge group:

$$\text{SU}(5) \otimes \text{SU}(2)_L \otimes \text{U}(1)_X$$

$$q \sim \begin{pmatrix} u \\ d \end{pmatrix} \quad \Psi \sim \begin{pmatrix} \Psi_u \\ \Psi_d \end{pmatrix}$$

⇒ Minimal matter content:

$$5_q \sim (5, 2, \frac{1}{10})_{\mathcal{G}_5} \sim \begin{pmatrix} q \\ \Psi \end{pmatrix}$$

$$\bar{5}_u \sim (\bar{5}, 1, -\frac{3}{5})_{\mathcal{G}_5} \sim \begin{pmatrix} u^c \\ \eta_u \end{pmatrix}$$

$$\bar{5}_d \sim (\bar{5}, 1, \frac{2}{5})_{\mathcal{G}_5} \sim \begin{pmatrix} d^c \\ \eta_d \end{pmatrix}$$



# The simplest gauge group

⇒ Gauge group:

$$SU(5) \otimes SU(2)_L \otimes U(1)_X$$

$$q \sim \begin{pmatrix} u \\ d \end{pmatrix} \quad \Psi \sim \begin{pmatrix} \Psi_u \\ \Psi_d \end{pmatrix}$$

⇒ Minimal matter content:

$$5_q \sim (5, 2, \frac{1}{10})_{\mathcal{G}_5} \sim \begin{pmatrix} q \\ \Psi \end{pmatrix}$$

$$\bar{5}_u \sim (\bar{5}, 1, -\frac{3}{5})_{\mathcal{G}_5} \sim \begin{pmatrix} u^c \\ \eta_u \end{pmatrix}$$

$$\bar{5}_d \sim (\bar{5}, 1, \frac{2}{5})_{\mathcal{G}_5} \sim \begin{pmatrix} d^c \\ \eta_d \end{pmatrix}$$

⇒ Breaking pattern:

$$SU(5) \otimes SU(2)_L \otimes U(1)_X \xrightarrow{\langle 24_H \rangle} SU(2)_D \otimes SU(3)_c \otimes SU(2)_L \otimes U(1)_5 \otimes U(1)_X$$

$$24_V \sim (24, 1, 0)_{\mathcal{G}_5} \sim \begin{pmatrix} G^\mu & V_{DQ}^\mu \sim (3, 1, \frac{1}{6}, 2) \\ \dagger & G_D^\mu \sim (1, 1, 0, 3) \end{pmatrix}$$



# The simplest gauge group

⇒ Gauge group:

$$\text{SU}(5) \otimes \text{SU}(2)_L \otimes \text{U}(1)_X$$

$$q \sim \begin{pmatrix} u \\ d \end{pmatrix} \quad \Psi \sim \begin{pmatrix} \Psi_u \\ \Psi_d \end{pmatrix}$$

⇒ Minimal matter content:

$$5_q \sim (5, 2, \frac{1}{10})_{\mathcal{G}_5} \sim \begin{pmatrix} q \\ \Psi \end{pmatrix}$$

$$\bar{5}_u \sim (\bar{5}, 1, -\frac{3}{5})_{\mathcal{G}_5} \sim \begin{pmatrix} u^c \\ \eta_u \end{pmatrix}$$

$$\bar{5}_d \sim (\bar{5}, 1, \frac{2}{5})_{\mathcal{G}_5} \sim \begin{pmatrix} d^c \\ \eta_d \end{pmatrix}$$

⇒ Breaking pattern:

$$\text{SU}(5) \otimes \text{SU}(2)_L \otimes \text{U}(1)_X \xrightarrow{\langle 24_H \rangle} \text{SU}(2)_D \otimes \text{SU}(3)_c \otimes \text{SU}(2)_L \otimes \text{U}(1)_5 \otimes \text{U}(1)_X$$

$$10_H \sim (10, 1, \frac{1}{5})_{\mathcal{G}_5}$$

$$\xrightarrow{\langle 10_H \rangle} \text{SU}(2)_D \otimes \text{SU}(3)_c \otimes \text{SU}(2)_L \otimes \text{U}(1)_Y$$

$$\sim \begin{pmatrix} S_1 \sim (\bar{3}, 1, \frac{1}{3}, 1) & R_D \sim (3, 1, \frac{1}{6}, 2) \\ -T & \delta_0 \sim (1, 1, 0, 1) \end{pmatrix}$$



$$24_V \sim (24, 1, 0)_{\mathcal{G}_5} \sim \begin{pmatrix} G^\mu & V_{DQ}^\mu \sim (3, 1, \frac{1}{6}, 2) \\ \dagger & G_D^\mu \sim (1, 1, 0, 3) \end{pmatrix}$$

# The simplest gauge group

⇒ Gauge group:  $SU(5) \otimes SU(2)_L \otimes U(1)_X$

⇒ Minimal matter content:

$$5_q \sim (5, 2, \frac{1}{10})_{\mathcal{G}_5} \sim \begin{pmatrix} q \\ \Psi \end{pmatrix}$$

$$\bar{5}_u \sim (\bar{5}, 1, -\frac{3}{5})_{\mathcal{G}_5} \sim \begin{pmatrix} u^c \\ \eta_u \end{pmatrix}$$

$$\bar{5}_d \sim (\bar{5}, 1, \frac{2}{5})_{\mathcal{G}_5} \sim \begin{pmatrix} d^c \\ \eta_d \end{pmatrix}$$

$$\mathcal{L}_Y \supset Y_u 5_q H \bar{5}_u + Y_d 5_q H^\dagger \bar{5}_d$$

Mass splitting

⇒ Breaking pattern:

$$SU(5) \otimes SU(2)_L \otimes U(1)_X \xrightarrow{\langle 24_H \rangle} SU(2)_D \otimes SU(3)_c \otimes SU(2)_L \otimes U(1)_5 \otimes U(1)_X$$

$$10_H \sim (10, 1, \frac{1}{5})_{\mathcal{G}_5}$$

$$\xrightarrow{\langle 10_H \rangle} SU(2)_D \otimes SU(3)_c \otimes SU(2)_L \otimes U(1)_Y$$

$$\sim \begin{pmatrix} S_1 \sim (\bar{3}, 1, \frac{1}{3}, 1) & R_D \sim (3, 1, \frac{1}{6}, 2) \\ -T & \delta_0 \sim (1, 1, 0, 1) \end{pmatrix}$$



$$24_V \sim (24, 1, 0)_{\mathcal{G}_5} \sim \begin{pmatrix} G^\mu & V_{DQ}^\mu \sim (3, 1, \frac{1}{6}, 2) \\ \dagger & G_D^\mu \sim (1, 1, 0, 3) \end{pmatrix}$$



# The simplest gauge group

⇒ Gauge group:  $SU(5) \otimes SU(2)_L \otimes U(1)_X$

⇒ Minimal matter content:

$$5_q \sim (5, 2, \frac{1}{10})_{\mathcal{G}_5} \sim \begin{pmatrix} q \\ \Psi \end{pmatrix}$$

$$\bar{5}_u \sim (\bar{5}, 1, -\frac{3}{5})_{\mathcal{G}_5} \sim \begin{pmatrix} u^c \\ \eta_u \end{pmatrix}$$

$$\bar{5}_d \sim (\bar{5}, 1, \frac{2}{5})_{\mathcal{G}_5} \sim \begin{pmatrix} d^c \\ \eta_d \end{pmatrix}$$

⇒ Breaking pattern:

$$SU(5) \otimes SU(2)_L \otimes U(1)_X \xrightarrow{\langle 24_H \rangle} SU(2)_D \otimes SU(3)_c \otimes SU(2)_L \otimes U(1)_5 \otimes U(1)_X$$

$$10_H \sim (10, 1, \frac{1}{5})_{\mathcal{G}_5}$$

$$\xrightarrow{\langle 10_H \rangle} SU(2)_D \otimes SU(3)_c \otimes SU(2)_L \otimes U(1)_Y$$

$$\sim \begin{pmatrix} S_1 \sim (\bar{3}, 1, \frac{1}{3}, 1) & R_D \sim (3, 1, \frac{1}{6}, 2) \\ -T & \delta_0 \sim (1, 1, 0, 1) \end{pmatrix}$$



$$\mathcal{L}_Y \supset Y_u 5_q H \bar{5}_u + Y_d 5_q H^\dagger \bar{5}_d$$

$$\text{☺} + Y_\eta \bar{5}_u \bar{5}_d 10_H + Y_\Psi 5_q 5_q 10_H^* + \text{h.c.}$$

Mass splitting

$$24_V \sim (24, 1, 0)_{\mathcal{G}_5} \sim \begin{pmatrix} G^\mu & V_{DQ}^\mu \sim (3, 1, \frac{1}{6}, 2) \\ \dagger & G_D^\mu \sim (1, 1, 0, 3) \end{pmatrix}$$

# The simplest gauge group

⇒ Gauge group:  $SU(5) \otimes SU(2)_L \otimes U(1)_X$

⇒ Minimal matter content:

$$5_q \sim (5, 2, \frac{1}{10})_{\mathcal{G}_5} \sim \begin{pmatrix} q \\ \Psi \end{pmatrix}$$

$$\bar{5}_u \sim (\bar{5}, 1, -\frac{3}{5})_{\mathcal{G}_5} \sim \begin{pmatrix} u^c \\ \eta_u \end{pmatrix}$$

$$\bar{5}_d \sim (\bar{5}, 1, \frac{2}{5})_{\mathcal{G}_5} \sim \begin{pmatrix} d^c \\ \eta_d \end{pmatrix}$$

⇒ Breaking pattern:

$$SU(5) \otimes SU(2)_L \otimes U(1)_X \xrightarrow{\langle 24_H \rangle} SU(2)_D \otimes SU(3)_c \otimes SU(2)_L \otimes U(1)_5 \otimes U(1)_X$$

$$10_H \sim (10, 1, \frac{1}{5})_{\mathcal{G}_5}$$

$$\xrightarrow{\langle 10_H \rangle} SU(2)_D \otimes SU(3)_c \otimes SU(2)_L \otimes U(1)_Y$$

$$\sim \begin{pmatrix} S_1 \sim (\bar{3}, 1, \frac{1}{3}, 1) & R_D \sim (3, 1, \frac{1}{6}, 2) \\ -T & \delta_0 \sim (1, 1, 0, 1) \end{pmatrix}$$



$$24_V \sim (24, 1, 0)_{\mathcal{G}_5} \sim \begin{pmatrix} G^\mu & V_{DQ}^\mu \sim (3, 1, \frac{1}{6}, 2) \\ \dagger & G_D^\mu \sim (1, 1, 0, 3) \end{pmatrix}$$

Mass splitting

$$\mathcal{L}_Y \supset Y_u 5_q H \bar{5}_u + Y_d 5_q H^\dagger \bar{5}_d$$

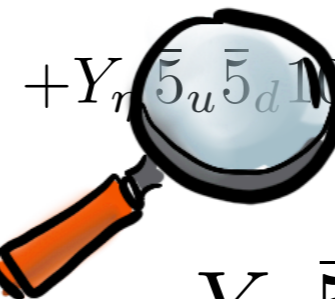

$$+ Y_\eta \bar{5}_u \bar{5}_d 10_H + Y_\Psi 5_q 5_q 10_H^* + \text{h.c.}$$

$$Y_\eta \bar{5}_{ui} \bar{5}_{dj} 10_H^{ij}$$

# The simplest gauge group

⇒ Gauge group:

$$SU(5) \otimes SU(2)_L \otimes U(1)_X$$

~~$$U(1)_Q$$~~

Quirk number violation!

⇒ Minimal matter content:

$$5_q \sim (5, 2, \frac{1}{10})_{\mathcal{G}_5} \sim \begin{pmatrix} q \\ \Psi \end{pmatrix}$$

$$\bar{5}_u \sim (\bar{5}, 1, -\frac{3}{5})_{\mathcal{G}_5} \sim \begin{pmatrix} u^c \\ \eta_u \end{pmatrix}$$

$$\bar{5}_d \sim (\bar{5}, 1, \frac{2}{5})_{\mathcal{G}_5} \sim \begin{pmatrix} d^c \\ \eta_d \end{pmatrix}$$

⇒ Breaking pattern:

$$SU(5) \otimes SU(2)_L \otimes U(1)_X \xrightarrow{\langle 24_H \rangle} SU(2)_D \otimes SU(3)_c \otimes SU(2)_L \otimes U(1)_5 \otimes U(1)_X$$

$$10_H \sim (10, 1, \frac{1}{5})_{\mathcal{G}_5}$$

$$\xrightarrow{\langle 10_H \rangle} SU(2)_D \otimes SU(3)_c \otimes SU(2)_L \otimes U(1)_Y$$

$$\sim \begin{pmatrix} S_1 \sim (\bar{3}, 1, \frac{1}{3}, 1) & R_D \sim (3, 1, \frac{1}{6}, 2) \\ -T & \delta_0 \sim (1, 1, 0, 1) \end{pmatrix}$$



$$24_V \sim (24, 1, 0)_{\mathcal{G}_5} \sim \begin{pmatrix} G^\mu & V_{DQ}^\mu \sim (3, 1, \frac{1}{6}, 2) \\ \dagger & G_D^\mu \sim (1, 1, 0, 3) \end{pmatrix}$$

Mass splitting

$$\mathcal{L}_Y \supset Y_u 5_q H \bar{5}_u + Y_d 5_q H^\dagger \bar{5}_d$$

$$+ Y_\eta \bar{5}_u \bar{5}_d 10_H + Y_\Psi 5_q 5_q 10_H^* + \text{h.c.}$$

$$\begin{pmatrix} \Psi_u & \eta_d \end{pmatrix} \begin{pmatrix} Y_\Psi v_{10} & Y_u v_{EW} \\ Y_d^T v_{EW} & Y_\eta^T v_{10} \end{pmatrix} \begin{pmatrix} \Psi_d \\ \eta_u \end{pmatrix} + \text{h.c.}$$

# The simplest gauge group

➔ Gauge group:

$$SU(5) \otimes SU(2)_L \otimes U(1)_X$$

~~U(1)<sub>Q</sub>~~  
Quirk number violation!

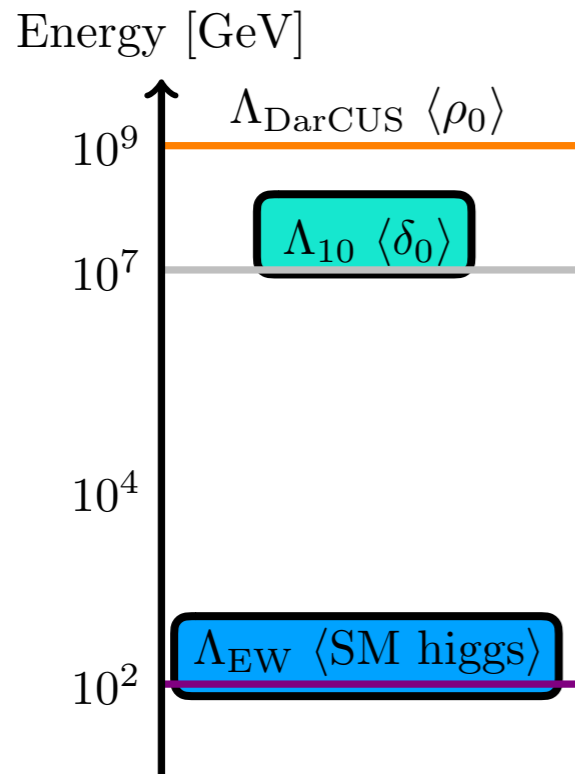

$$\mathcal{L}_Y \supset Y_u 5_q H \bar{5}_u + Y_d 5_q H^\dagger \bar{5}_d$$

Mass splitting

$$+ Y_\eta \bar{5}_u \bar{5}_d 10_H + Y_\Psi 5_q 5_q 10_H^* + \text{h.c.}$$

$$\begin{pmatrix} \Psi_u & \eta_d \end{pmatrix} \begin{pmatrix} \mathbf{10} & \mathbf{EW} \\ \mathbf{EW} & \mathbf{10} \end{pmatrix} \begin{pmatrix} \Psi_d \\ \eta_u \end{pmatrix} + \text{h.c.}$$

$$10_H \sim (10, 1, \frac{1}{5})_{\mathcal{G}_5}$$

$$\xrightarrow{\langle 10_H \rangle} SU(2)_D \otimes SU(3)_c \otimes SU(2)_L \otimes U(1)_Y$$

$$\sim \begin{pmatrix} S_1 \sim (\bar{3}, 1, \frac{1}{3}, 1) & R_D \sim (3, 1, \frac{1}{6}, 2) \\ -T & \delta_0 \sim (1, 1, 0, 1) \end{pmatrix}$$



$$24_V \sim (24, 1, 0)_{\mathcal{G}_5} \sim \begin{pmatrix} G^\mu & V_{DQ}^\mu \sim (3, 1, \frac{1}{6}, 2) \\ \dagger & G_D^\mu \sim (1, 1, 0, 3) \end{pmatrix}$$

# The simplest gauge group

⇒ Gauge group:  $SU(5) \otimes SU(2)_L \otimes U(1)_X$

⇒ Minimal matter content:

$$5_q \sim (5, 2, \frac{1}{10})_{\mathcal{G}_5} \sim \begin{pmatrix} q \\ \Psi \end{pmatrix}$$

$$\bar{5}_u \sim (\bar{5}, 1, -\frac{3}{5})_{\mathcal{G}_5} \sim \begin{pmatrix} u^c \\ \eta_u \end{pmatrix}$$

$$\bar{5}_d \sim (\bar{5}, 1, \frac{2}{5})_{\mathcal{G}_5} \sim \begin{pmatrix} d^c \\ \eta_d \end{pmatrix}$$



$$\ell \sim (1, 2, \frac{1}{2})$$

$$e^c \sim (1, 1, 1)$$

$$N \sim (1, 1, 0)$$

$$SU(5) \otimes SU(2)_L \otimes U(1)_X \xrightarrow{\langle 24_H \rangle} SU(2)_D \otimes SU(3)_c \otimes SU(2)_L \otimes U(1)_5 \otimes U(1)_X$$

$$10_H \sim (10, 1, \frac{1}{5})_{\mathcal{G}_5}$$

$$\xrightarrow{\langle 10_H \rangle} SU(2)_D \otimes SU(3)_c \otimes SU(2)_L \otimes U(1)_Y$$

$$\sim \begin{pmatrix} S_1 \sim (\bar{3}, 1, \frac{1}{3}, 1) & R_D \sim (3, 1, \frac{1}{6}, 2) \\ -T & \delta_0 \sim (1, 1, 0, 1) \end{pmatrix}$$

$$24_V \sim (24, 1, 0)_{\mathcal{G}_5} \sim \begin{pmatrix} G^\mu & V_{DQ}^\mu \sim (3, 1, \frac{1}{6}, 2) \\ \dagger & G_D^\mu \sim (1, 1, 0, 3) \end{pmatrix}$$



# The Dark Sector

- **3** representations of  $SU(5)$  -



# The Dark Sector

$$\Rightarrow 5_\chi \sim (5, 1, \frac{1}{10})_{\mathcal{G}_5} \sim \begin{pmatrix} qN^\alpha \\ \chi \end{pmatrix}, \bar{5}_\chi$$

$$\chi \sim (1, 1, 0, 2)$$

Dark quark



# The Dark Sector

$$\Rightarrow 5_\chi \sim (5, 1, \frac{1}{10})_{\mathcal{G}_5} \sim \begin{pmatrix} q_N^\alpha \\ \chi \end{pmatrix}, \bar{5}_\chi$$

$$\chi \sim (1, 1, 0, 2)$$

Dark quark

$$\Rightarrow 10 \sim (10, 1, -\frac{3}{10})_{\mathcal{G}_5} \sim \begin{pmatrix} Q_N^{c\beta\gamma} & M \\ & \xi \end{pmatrix}, \bar{10}$$

$$\mathcal{L}_{\text{DS}} \supset Y_q 5_\chi 10 10_H \epsilon_5 + Y_{\bar{q}} \bar{5}_\chi \bar{10} 10_H^* \epsilon_5 + \text{h.c.}$$





# The Dark Sector

→  $5_\chi \sim (5, 1, \frac{1}{10})_{\mathcal{G}_5} \sim \begin{pmatrix} q_N^\alpha \\ \chi \end{pmatrix}, \bar{5}_\chi$

$\chi \sim (1, 1, 0, 2)$

Dark quark

→  $10 \sim (10, 1, -\frac{3}{10})_{\mathcal{G}_5} \sim \begin{pmatrix} Q_N^{c\beta\gamma} & M \\ & \xi \end{pmatrix}, \bar{10}$

$Y_q 5_\chi^\alpha 10^{\beta\gamma} 10_H^{ij} \epsilon_{\alpha\beta\gamma} \epsilon_{ij}$



$\mathcal{L}_{DS} \supset Y_q 5_\chi 10 10_H \epsilon_5 + Y_{\bar{q}} \bar{5}_\chi \bar{10} 10_H^* \epsilon_5 + \text{h.c.}$

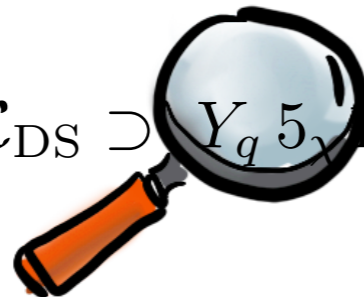

$10_H \sim \begin{pmatrix} S_1 & R_D \\ & \delta_0^{ij} \end{pmatrix}$

# The Dark Sector

$$\Rightarrow 5_\chi \sim (5, 1, \frac{1}{10})_{\mathcal{G}_5} \sim \begin{pmatrix} q_N^\alpha \\ \chi \end{pmatrix}, \bar{5}_\chi$$

$$\chi \sim (1, 1, 0, 2)$$

Dark quark

$$\Rightarrow 10 \sim (10, 1, -\frac{3}{10})_{\mathcal{G}_5} \sim \begin{pmatrix} Q_N^{c\beta\gamma} & M \\ & \xi \end{pmatrix}, \bar{10}$$

$$\Rightarrow 5_H \sim (5, 1, \frac{1}{10})_{\mathcal{G}_5} \sim \begin{pmatrix} \Omega \\ \Delta_0 \end{pmatrix} \sim (1, 1, 0, 2)$$

Splitting DM – new quarks

$$\mathcal{L}_{\text{DS}} \supset Y_q 5_\chi 10 10_H \epsilon_5 + Y_{\bar{q}} \bar{5}_\chi \bar{10} 10_H^* \epsilon_5$$

$$+ Y_{\Delta_0} \bar{5}_d 10 5_H^* + Y_{\bar{\chi}} \bar{5}_\chi 5_H N + Y_\chi 5_\chi 5_H^* N + \text{h.c.}$$



# Running

$$\alpha_S^{-1}(\mu) = \alpha_S^{-1}(\Lambda_S) - \frac{1}{2\pi} \left( \sum_{i, m_i < \Lambda_S} b_i \ln \left( \frac{\mu}{\Lambda_S} \right) + \sum_{i, m_i > \Lambda_S} b_i \ln \left( \frac{\mu}{M_i} \right) \right)$$

$$b_i = \frac{1}{3} \sum_R S(R) T_i(R) \prod_{j \neq i} \dim_j(R)$$

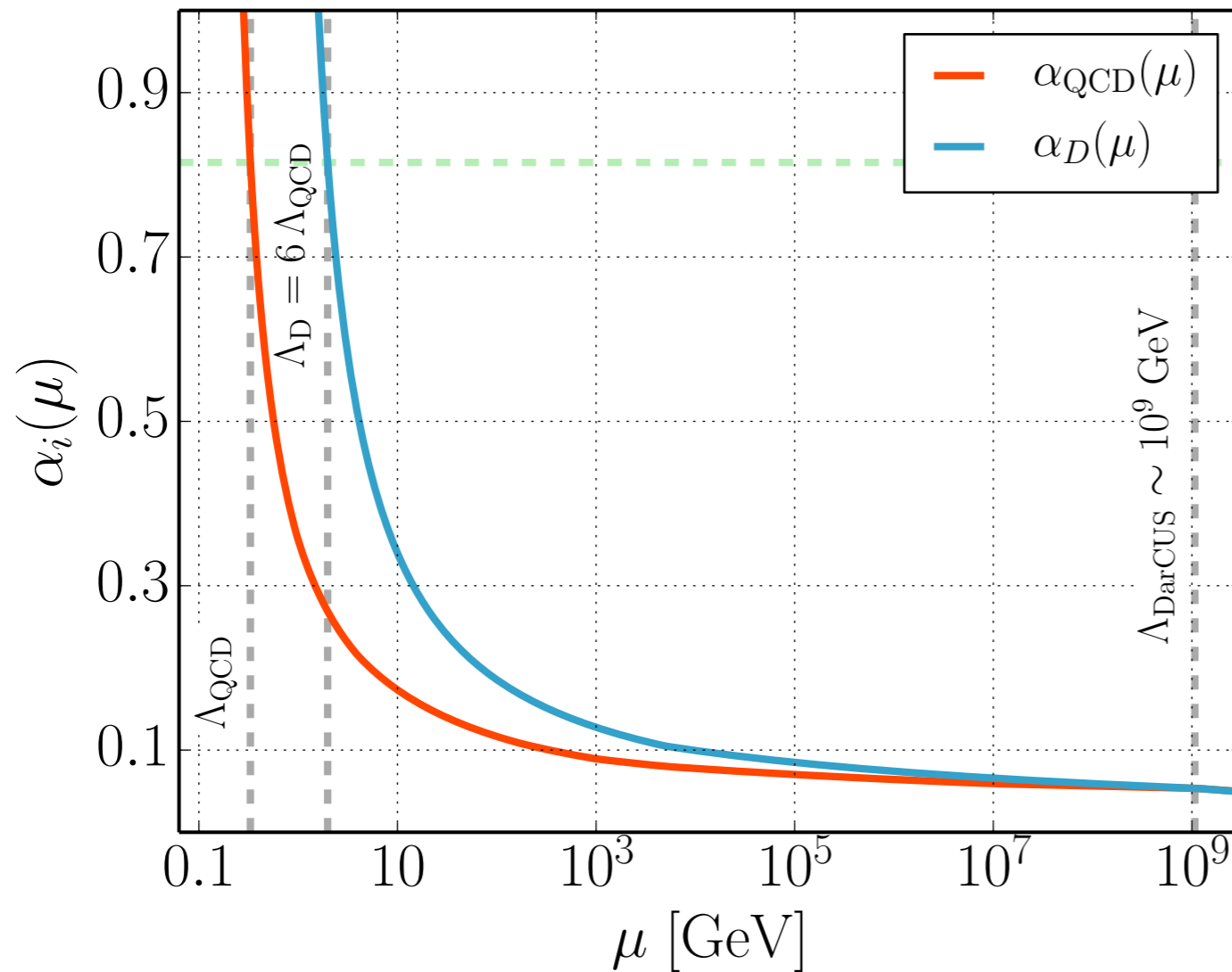

# Running

$$\alpha_S^{-1}(\mu) = \alpha_S^{-1}(\Lambda_S) - \frac{1}{2\pi} \left( \sum_{i, m_i < \Lambda_S} b_i \ln \left( \frac{\mu}{\Lambda_S} \right) + \sum_{i, m_i > \Lambda_S} b_i \ln \left( \frac{\mu}{M_i} \right) \right)$$

$$b_i = \frac{1}{3} \sum_R S(R) T_i(R) \prod_{j \neq i} \dim_j(R)$$

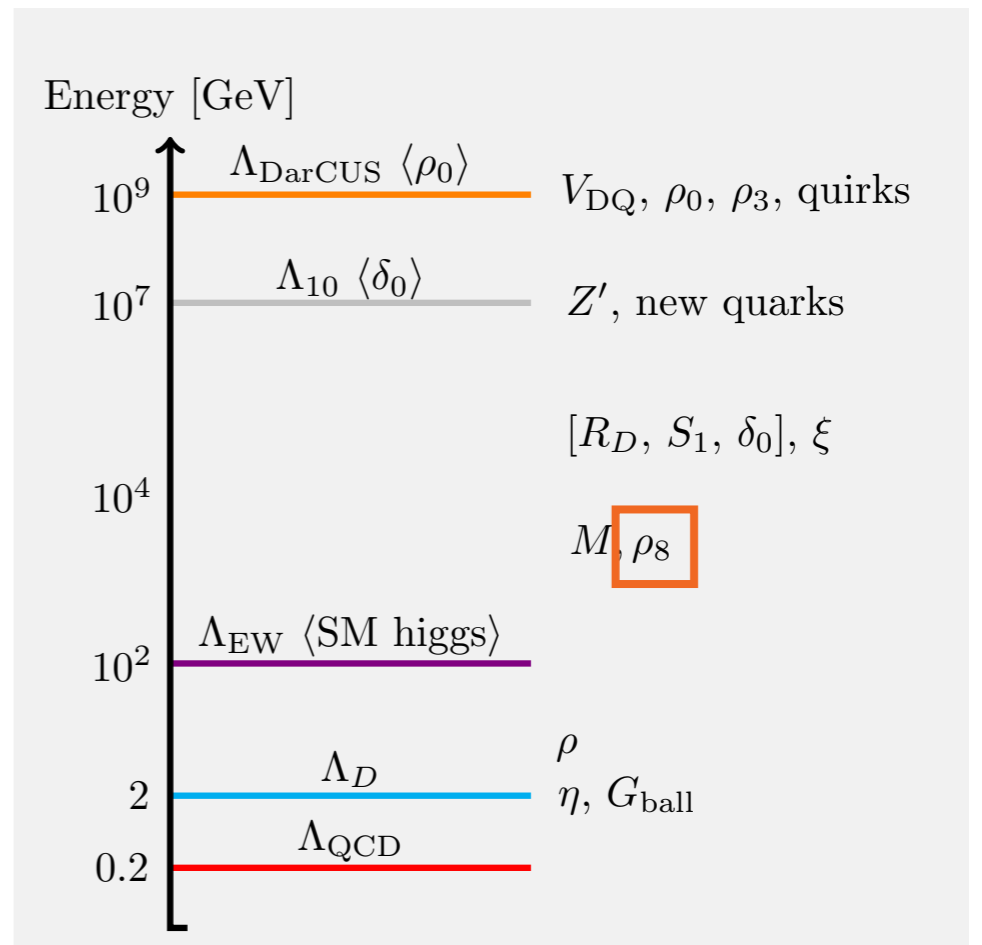
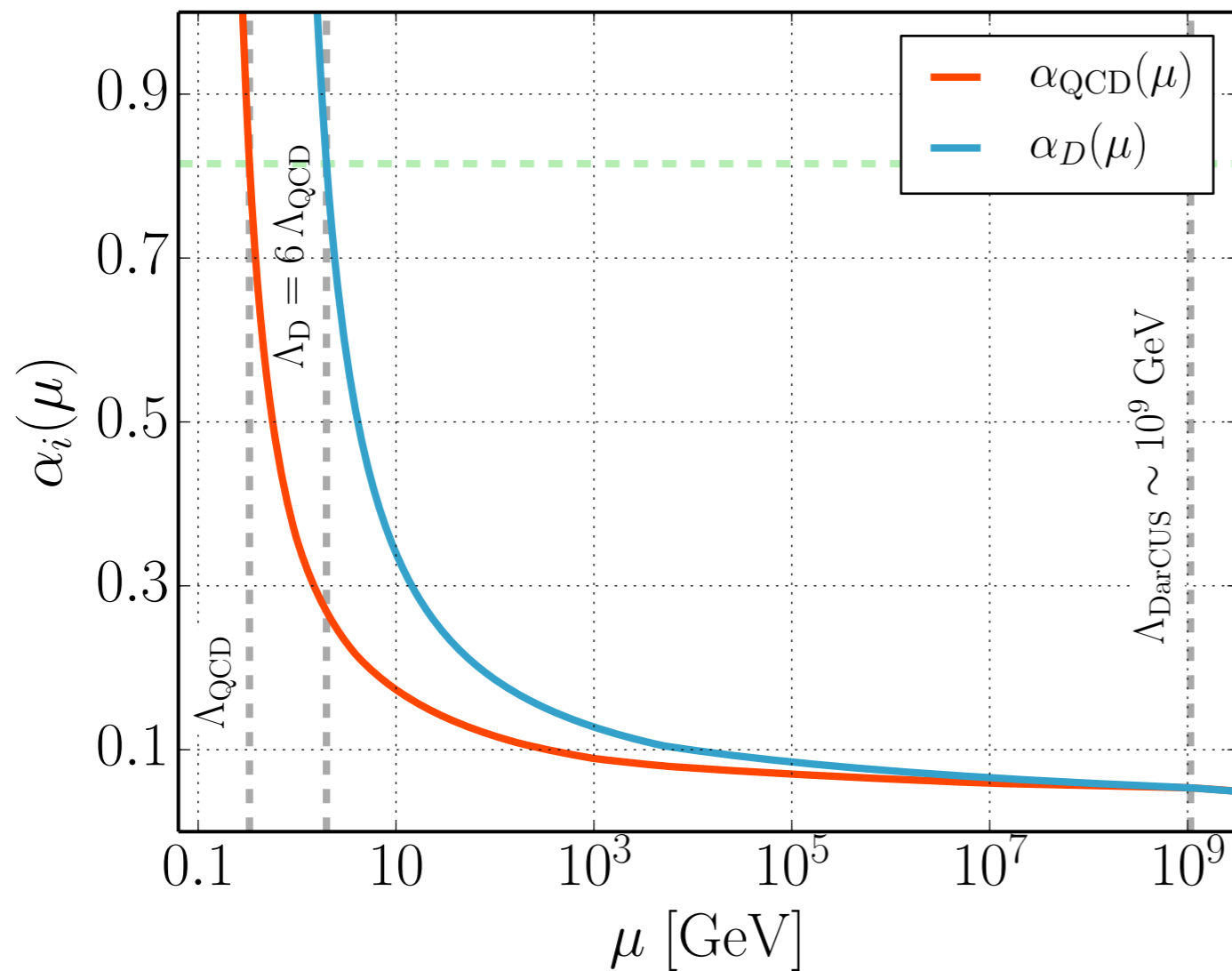

# Dark Spectrum

⇒ One (light) flavor  $\bar{\chi} + \text{SU}(2)_D$

$$\boxed{2 \equiv \square \equiv \bar{2} \quad \text{enlarged symmetry!}} \quad \text{U}(1)_L \otimes \text{U}(1)_R \xrightarrow{\text{enlarged}} \text{U}(2) = \text{U}(1)_A \otimes \text{SU}(2)$$



# Dark Spectrum

[Francis, Hudspith, Lewis, Tulin, 2008]

⇒ One (light) flavor  $\bar{\chi} + \text{SU}(2)_D$

$2 \equiv \square \equiv \bar{2}$  enlarged symmetry!

$$\text{U}(1)_L \otimes \text{U}(1)_R \xrightarrow{\text{enlarged}} \text{U}(2) = \text{U}(1)_A \otimes \text{SU}(2)$$



No Goldstones! (No dark pions)

$$\begin{array}{c} | \\ \chi\text{SB} \quad \langle \bar{\chi}\chi \rangle \\ \downarrow \\ \text{Sp}(2) \end{array}$$



# Dark Spectrum

⇒ One (light) flavor  $\bar{\chi} + \text{SU}(2)_D$

$2 \equiv \square \equiv \bar{2}$  enlarged symmetry!

$$U(1)_L \otimes U(1)_R \xrightarrow{\text{enlarged}} U(2) = U(1)_A \otimes \text{SU}(2)$$



No Goldstones! (No dark pions)

$$\begin{array}{c} | \\ \chi\text{SB} \quad \langle \bar{\chi}\chi \rangle \\ \downarrow \\ \text{Sp}(2) \end{array}$$

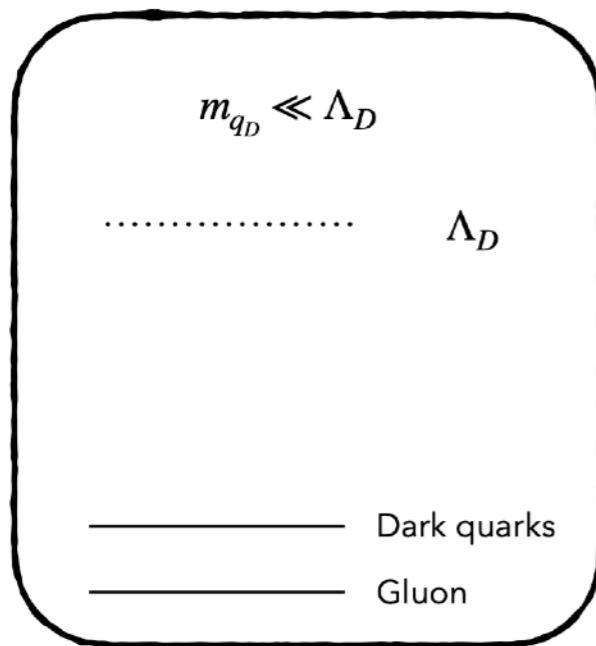

In IR →

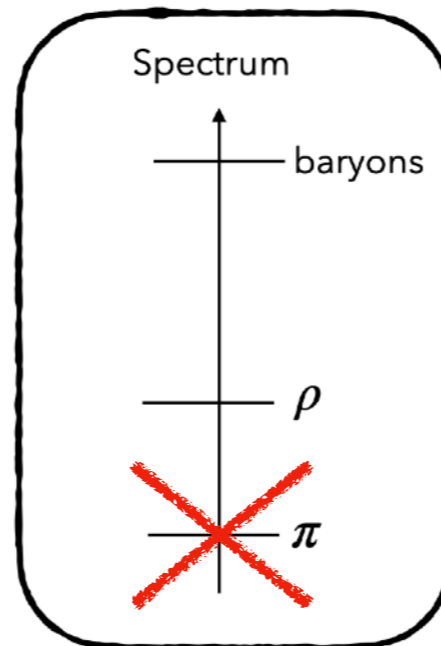

[Borrowed from talk Suchita on Tuesday]

•  $N_{c_D} = 2$  and/or  $N_{f_D} = 1$  special cases



# Dark Spectrum

[Francis, Hudspith, Lewis, Tulin, 2008]

⇒ One (light) flavor  $\bar{\chi} + \text{SU}(2)_D$

$2 \equiv \square \equiv \bar{2}$  enlarged symmetry!

$$\text{U}(1)_L \otimes \text{U}(1)_R \xrightarrow{\text{enlarged}} \text{U}(2) = \text{U}(1)_A \otimes \text{SU}(2)$$



No Goldstones! (No dark pions)

$$\begin{array}{c} | \\ \chi\text{SB} \quad \langle \bar{\chi}\chi \rangle \\ \downarrow \\ \text{Sp}(2) \end{array}$$

Dark (matter) baryon

$$\text{vector } (1^-) \quad \rho = \begin{pmatrix} \rho^+ \\ \rho^0 \\ \rho^- \end{pmatrix} \sim \begin{pmatrix} \chi\chi \\ \frac{1}{\sqrt{2}}(\chi\bar{\chi} + \bar{\chi}\chi) \\ \bar{\chi}\bar{\chi} \end{pmatrix}$$





# Dark Spectrum

[Francis, Hudspith, Lewis, Tulin, 2008]

⇒ One (light) flavor  $\bar{\chi} + \text{SU}(2)_D$

$2 \equiv \square \equiv \bar{2}$  enlarged symmetry!

$$\text{U}(1)_L \otimes \text{U}(1)_R \xrightarrow{\text{enlarged}} \text{U}(2) = \text{U}(1)_A \otimes \text{SU}(2)$$



No Goldstones! (No dark pions)

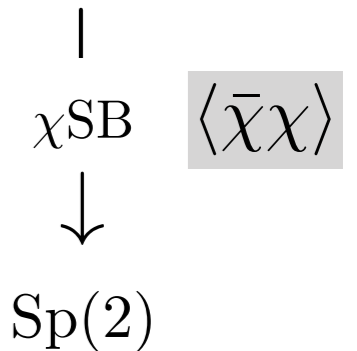

Dark (matter) baryon

vector  $(1^-)$       $\rho = \begin{pmatrix} \rho^+ \\ \rho^0 \\ \rho^- \end{pmatrix} \sim \begin{pmatrix} \chi\chi \\ \frac{1}{\sqrt{2}}(\chi\bar{\chi} + \bar{\chi}\chi) \\ \bar{\chi}\bar{\chi} \end{pmatrix}$

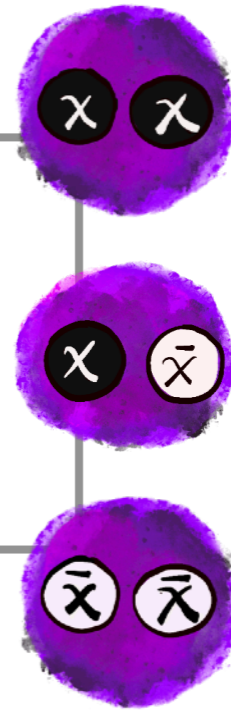

$$Q_D \left( \text{circle with } \chi \right) = \frac{1}{2}$$

Dark Baryon Number  $\text{U}(1)_D$



# Dark Spectrum

[Francis, Hudspith, Lewis, Tulin, 2008]

⇒ One (light) flavor  $\bar{\chi} + \text{SU}(2)_D$

$2 \equiv \square \equiv \bar{2}$  enlarged symmetry!

$$\text{U}(1)_L \otimes \text{U}(1)_R \xrightarrow{\text{enlarged}} \text{U}(2) = \text{U}(1)_A \otimes \text{SU}(2)$$



No Goldstones! (No dark pions)

$$\begin{array}{c} | \\ \chi\text{SB} \quad \langle \bar{\chi}\chi \rangle \\ \downarrow \\ \text{Sp}(2) \end{array}$$

Dark (matter) baryon

$$\text{vector } (1^-) \quad \rho = \begin{pmatrix} \rho^+ \\ \rho^0 \\ \rho^- \end{pmatrix} \sim \begin{pmatrix} \chi\chi \\ \frac{1}{\sqrt{2}}(\chi\bar{\chi} + \bar{\chi}\chi) \\ \bar{\chi}\bar{\chi} \end{pmatrix}$$

Glueballs

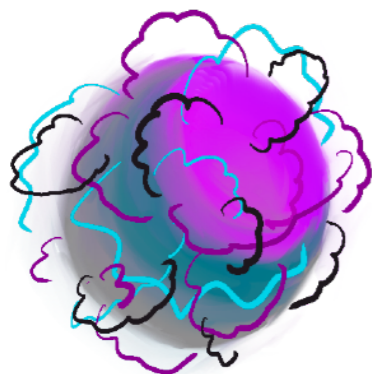

$$G_{\text{ball}} \equiv \langle G_D G_D \rangle$$

$$m_{G_{\text{ball}}} \sim \mathcal{O}(1)\Lambda_D$$



# Dark Spectrum

[Francis, Hudspith, Lewis, Tulin, 2008]

⇒ One (light) flavor  $\bar{\chi} + \text{SU}(2)_D$

$2 \equiv \square \equiv \bar{2}$  enlarged symmetry!

$$\text{U}(1)_L \otimes \text{U}(1)_R \xrightarrow{\text{enlarged}} \text{U}(2) = \text{U}(1)_A \otimes \text{SU}(2)$$



No Goldstones! (No dark pions)

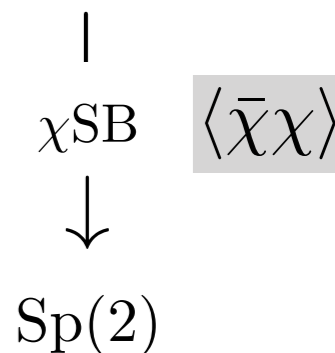

Dark (matter) baryon

$$\text{vector } (1^-) \quad \rho = \begin{pmatrix} \rho^+ \\ \rho^0 \\ \rho^- \end{pmatrix} \sim \begin{pmatrix} \chi\chi \\ \frac{1}{\sqrt{2}}(\chi\bar{\chi} + \bar{\chi}\chi) \\ \bar{\chi}\bar{\chi} \end{pmatrix}$$

Glueballs

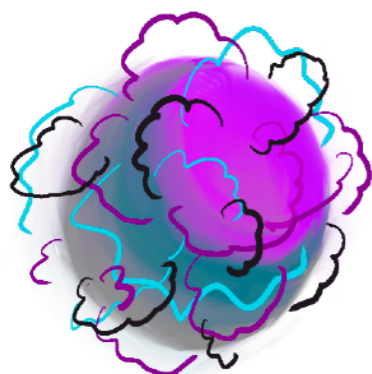

$$G_{\text{ball}} \equiv \langle G_D G_D \rangle$$

$$m_{G_{\text{ball}}} \sim \mathcal{O}(1)\Lambda_D$$

pseudoscalar ( $0^-$ )

Eta meson

$$\eta \equiv \bar{\chi}\gamma_5\chi$$

$$m_\rho > m_\eta \quad (\text{in QCD } m_\rho < m_{\eta'})$$



# Symmetries

	$5_q$		$\bar{5}_u$		$\bar{5}_d$		$5_\chi$		10			$10_H$		
Sym	$\Psi$	$q$	$u^c$	$\eta_u$	$d^c$	$\eta_d$	$\chi$	$q_N$	$Q_N^c$	$M$	$\xi$	$S_1$	$R_D$	$\delta_0$
$U(1)_B$	-	1/3	-1/3	-	-1/3	-	-	1/3	-1/3	-2/3	-1	2/3	1/3	-
$U(1)_D$	-	-	-	-	-	-	1/2	1/2	-1/2	-1/2	-1/2	-	-	-
$U(1)_Q$	1/2	-	-	-1/2	-	-1/2	-	-1/2	-1/2	-	1/2	-	1/2	1

Splitting quarks – quirks

$$\mathcal{L} \supset Y_\Psi 5_\Psi 5_\Psi 10_H^* + Y_\eta \bar{5}_d \bar{5}_u 10_H$$

$$+ Y_q 5_\chi 10 10_H \epsilon_5 + Y_{\bar{q}} \bar{5}_\chi \bar{10} \bar{10} \epsilon_5 + \text{h.c.}$$

Splitting DM – new quarks

The (unwanted)  $\mathcal{F}_2$  group

Quirks  $V_{DQ}^\mu$   $\xi$   
 New quarks  $R_D$

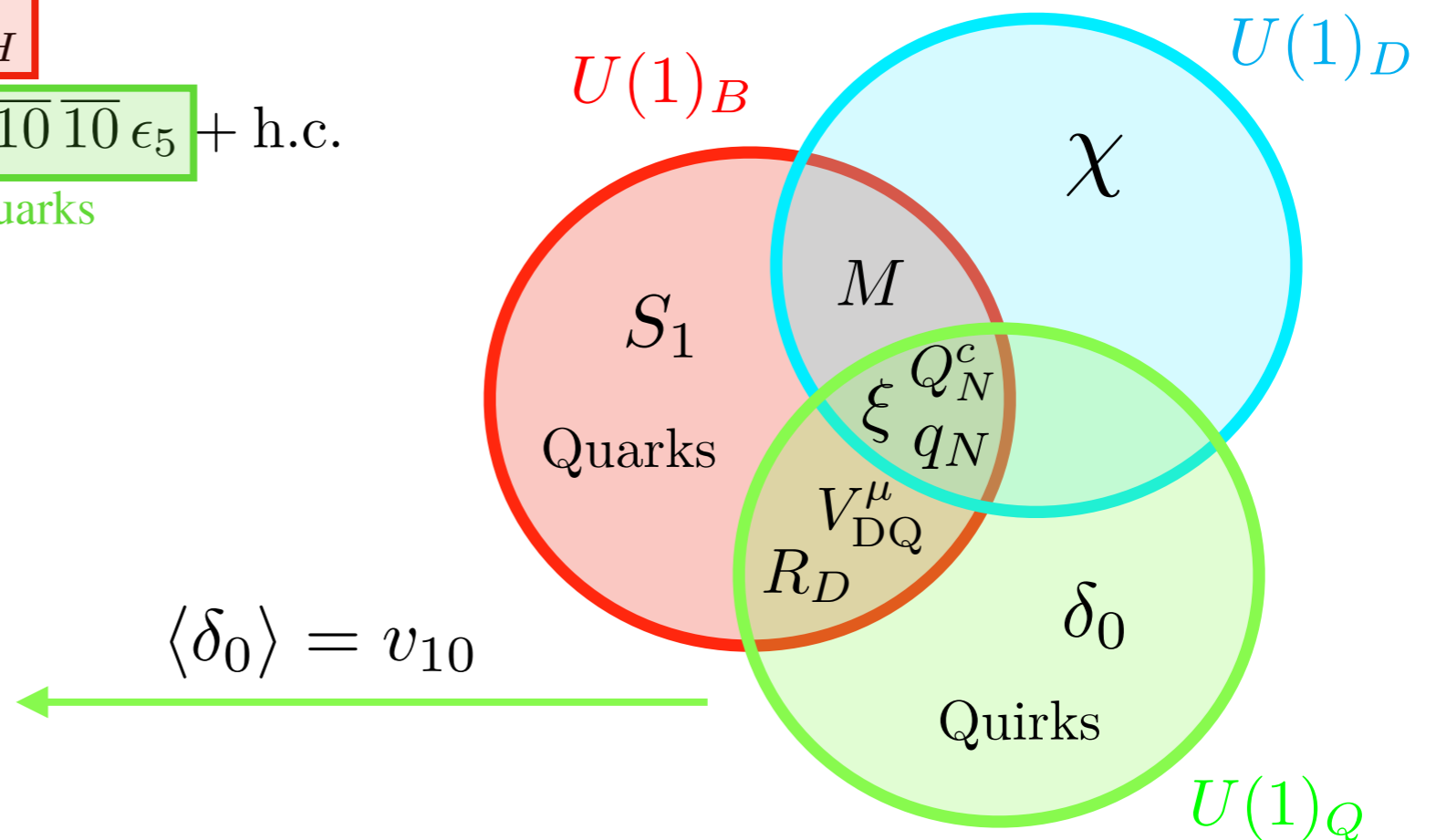

# Cosmology



# Darko-Baryo-Genesis

⇒ Asymmetry generation ingredients (Sakharov):

- 1 Violation of  $U(1)_B$  and  $U(1)_D$



Wait...



# Symmetries

	$5_q$		$\bar{5}_u$		$\bar{5}_d$		$5_\chi$		10			$10_H$		
Sym	$\Psi$	$q$	$u^c$	$\eta_u$	$d^c$	$\eta_d$	$\chi$	$q_N$	$Q_N^c$	$M$	$\xi$	$S_1$	$R_D$	$\delta_0$
$U(1)_B$	-	1/3	-1/3	-	-1/3	-	-	1/3	-1/3	-2/3	-1	2/3	1/3	-
$U(1)_D$	-	-	-	-	-	-	1/2	1/2	-1/2	-1/2	-1/2	-	-	-
$U(1)_Q$	1/2	-	-	-1/2	-	-1/2	-	-1/2	-1/2	-	1/2	-	1/2	1

Splitting quarks – quirks

$$\begin{aligned}
 \mathcal{L} \supset & Y_\Psi 5_\Psi 5_\Psi 10_H^* + Y_\eta \bar{5}_d \bar{5}_u 10_H \quad \text{Splitting DM – new quarks} \\
 & + Y_q 5_\chi 10 10_H \epsilon_5 + Y_{\bar{q}} \bar{5}_\chi \bar{10} \bar{10} \epsilon_5 \\
 & + Y_{\Delta_0} \bar{5}_d 10 5_H^* + Y_{\bar{\chi}} \bar{5}_\chi 5_H N + Y_\chi 5_\chi 5_H^* N + \text{h.c.}
 \end{aligned}$$

$$5_H \sim \begin{pmatrix} \Omega \\ \Delta_0 \end{pmatrix}$$



# Symmetries

	$5_q$		$\bar{5}_u$		$\bar{5}_d$		$5_\chi$		10			$10_H$		
Sym	$\Psi$	$q$	$u^c$	$\eta_u$	$d^c$	$\eta_d$	$\chi$	$q_N$	$Q_N^c$	$M$	$\xi$	$S_1$	$R_D$	$\delta_0$
$U(1)_B$	-	1/3	-1/3	-	-1/3	-	-	1/3	-1/3	-2/3	-1	2/3	1/3	-
$U(1)_D$	-	-	-	-	-	-	1/2	1/2	-1/2	-1/2	-1/2	-	-	-
$U(1)_Q$	1/2	-	-	-1/2	-	-1/2	-	-1/2	-1/2	-	1/2	-	1/2	1

Splitting quarks – quirks

$$\mathcal{L} \supset Y_\Psi 5_\Psi 5_\Psi 10_H^* + Y_\eta \bar{5}_d \bar{5}_u 10_H \quad \text{Splitting DM – new quarks}$$

$$+ Y_q 5_\chi 10 10_H \epsilon_5 + Y_{\bar{q}} \bar{5}_\chi \bar{10} \bar{10} \epsilon_5$$

$$+ Y_{\Delta_0} \bar{5}_d 10 5_H^* + Y_{\bar{\chi}} \bar{5}_\chi 5_H N + Y_\chi 5_\chi 5_H^* N + \text{h.c.}$$

$$5_H \sim \begin{pmatrix} \Omega \\ \Delta_0 \end{pmatrix}$$

$$\Rightarrow \mathcal{L} \supset Y_{\Delta_0} (d^c Q_N^c \Omega^* + \eta_d M \Omega^* + d^c M \Delta_0^* + \eta_d \xi \Delta_0^*)$$

$$+ Y_\chi (\chi \Delta_0^* + q_N \Omega^*) N + Y_{\bar{\chi}} (q_N^c \Omega + \chi^c \Delta_0) N + \text{h.c.}$$

$$Q_B(\Delta_0) = -1$$

$$Q_D(\Delta_0) = -1/2$$

$$Q_B(\chi \Delta_0^* N) = 1$$

$$Q_D(\chi \Delta_0^* N) = 1$$





# Symmetries

	$5_q$		$\bar{5}_u$		$\bar{5}_d$		$5_\chi$		10			$10_H$		
Sym	$\Psi$	$q$	$u^c$	$\eta_u$	$d^c$	$\eta_d$	$\chi$	$q_N$	$Q_N^c$	$M$	$\xi$	$S_1$	$R_D$	$\delta_0$
$U(1)_B$	-	1/3	-1/3	-	-1/3	-	-	1/3	-1/3	-2/3	-1	2/3	1/3	-
$U(1)_D$	-	-	-	-	-	-	1/2	1/2	-1/2	-1/2	-1/2	-	-	-
$U(1)_Q$	1/2	-	-	-1/2	-	-1/2	-	-1/2	-1/2	-	1/2	-	1/2	1

Splitting quarks – quirks

$$\mathcal{L} \supset Y_\Psi 5_\Psi 5_\Psi 10_H^* + Y_\eta \bar{5}_d \bar{5}_u 10_H \quad \text{Splitting DM – new quarks}$$

$$+ Y_q 5_\chi 10 10_H \epsilon_5 + Y_{\bar{q}} \bar{5}_\chi \bar{10} \bar{10} \epsilon_5$$

$$+ Y_{\Delta_0} \bar{5}_d 10 5_H^* + Y_{\bar{\chi}} \bar{5}_\chi 5_H N + Y_\chi 5_\chi 5_H^* N + \text{h.c.}$$

$$5_H \sim \begin{pmatrix} \Omega \\ \Delta_0 \end{pmatrix}$$

$$\Rightarrow \mathcal{L} \supset Y_{\Delta_0} (d^c Q_N^c \Omega^* + \eta_d M \Omega^* + d^c M \Delta_0^* + \eta_d \xi \Delta_0^*)$$

$$+ Y_\chi (\chi \Delta_0^* + q_N \Omega^*) N + Y_{\bar{\chi}} (q_N^c \Omega + \chi^c \Delta_0) N + \text{h.c.}$$

$$Q_B(\Delta_0) = -1$$

$$Q_D(\Delta_0) = -1/2$$

$$Q_B(\chi \Delta_0^* N) = 1$$

$$Q_D(\chi \Delta_0^* N) = 1$$

$$\Rightarrow U(1)_{B-D}$$



# Symmetries

	$5_q$		$\bar{5}_u$		$\bar{5}_d$		$5_\chi$		10			$10_H$		
Sym	$\Psi$	$q$	$u^c$	$\eta_u$	$d^c$	$\eta_d$	$\chi$	$q_N$	$Q_N^c$	$M$	$\xi$	$S_1$	$R_D$	$\delta_0$
$U(1)_B$	-	1/3	-1/3	-	-1/3	-	-	1/3	-1/3	-2/3	-1	2/3	1/3	-
$U(1)_D$	-	-	-	-	-	-	1/2	1/2	-1/2	-1/2	-1/2	-	-	-
$U(1)_Q$	1/2	-	-	-1/2	-	-1/2	-	-1/2	-1/2	-1/2	1/2	-	-	-

Splitting quarks – quirks

$$\mathcal{L} \supset Y_\Psi 5_\Psi 5_\Psi 10_H^* + Y_\eta \bar{5}_d \bar{5}_u 10_H \quad \text{Splitting DM – new quarks}$$

$$+ Y_q 5_\chi 10 10_H \epsilon_5 + Y_{\bar{q}} \bar{5}_\chi \bar{10} \bar{10} \epsilon_5$$

$$+ Y_{\Delta_0} \bar{5}_d 10 5_H^* + Y_{\bar{\chi}} \bar{5}_\chi 5_H N + Y_\chi 5_\chi 5_H^* N + \text{h.c.}$$

$$\Rightarrow \mathcal{L} \supset Y_{\Delta_0} (d^c Q_N^c \Omega^* + \eta_d M \Omega^* + d^c M \Delta_0^* + \eta_d \xi \Delta_0^*)$$

$$+ Y_\chi (\chi \Delta_0^* + q_N \Omega^*) N + Y_{\bar{\chi}} (q_N^c \Omega + \chi^c \Delta_0) N + \text{h.c.}$$

$$Q_B(\Delta_0) = -1$$

$$Q_D(\Delta_0) = -1/2$$

$$Q_B(\chi \Delta_0^* N) = 1$$

$$Q_D(\chi \Delta_0^* N) = 1$$

$$\Rightarrow U(1)_{B-D}$$

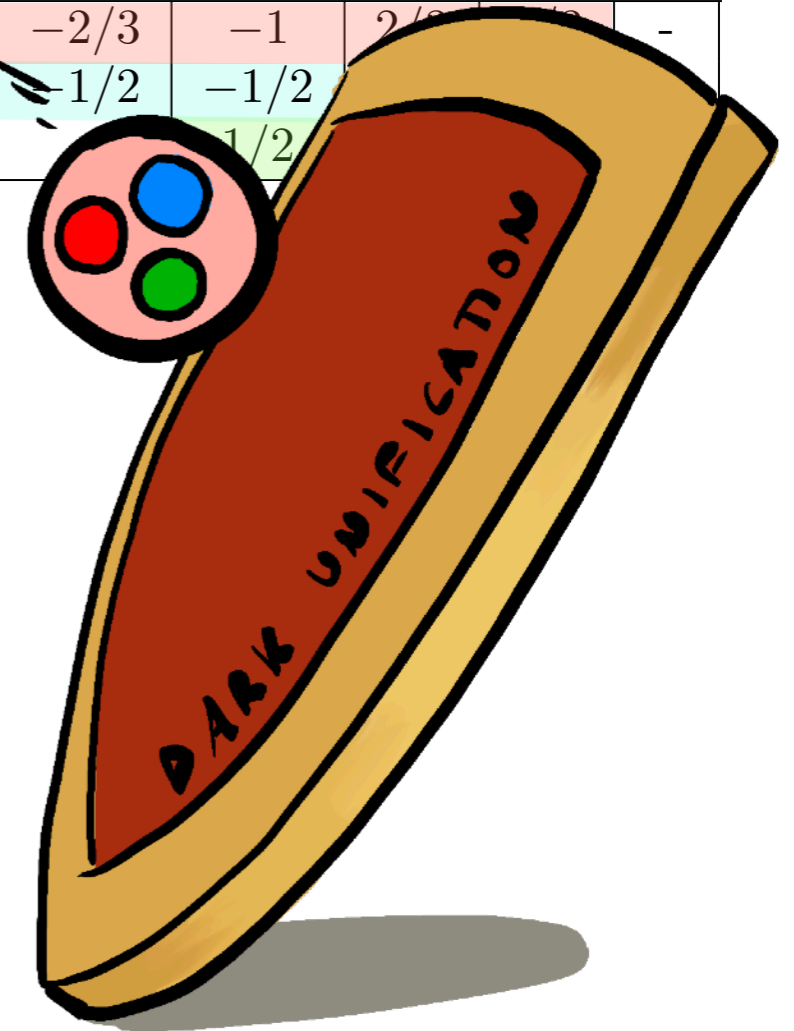

# Symmetries

	$5_q$		$\bar{5}_u$		$\bar{5}_d$		$5_\chi$		10			$10_H$		
Sym	$\Psi$	$q$	$u^c$	$\eta_u$	$d^c$	$\eta_d$	$\chi$	$q_N$	$Q_N^c$	$M$	$\xi$	$S_1$	$R_D$	$\delta_0$
$U(1)_B$	-	1/3	-1/3	-	-1/3	-	-	1/3	-1/3	-2/3	-1	2/3	1/3	-
$U(1)_D$	-	-	-	-	-	-	1/2	1/2	-1/2	-1/2	1/2	-	-	-
$U(1)_Q$	1/2	-	-	-1/2	-	-1/2	-	-1/2	-1/2	-	-	-	-	-

Splitting quarks – quirks

$$\mathcal{L} \supset Y_\Psi 5_\Psi 5_\Psi 10_H^* + Y_\eta \bar{5}_d \bar{5}_u 10_H \quad \text{Splitting DM – new quarks}$$

$$+ Y_q 5_\chi 10 10_H \epsilon_5 + Y_{\bar{q}} \bar{5}_\chi \bar{10} \bar{10} \epsilon_5$$

$$+ Y_{\Delta_0} \bar{5}_d 10 5_H^* + Y_{\bar{\chi}} \bar{5}_\chi 5_H N + Y_\chi 5_\chi 5_H^* N + \text{h.c.}$$

$$\Rightarrow \mathcal{L} \supset Y_{\Delta_0} (d^c Q_N^c \Omega^* + \eta_d M \Omega^* + d^c M \Delta_0^* + \eta_d \xi \Delta_0^*)$$

$$+ Y_\chi (\chi \Delta_0^* + q_N \Omega^*) N + Y_{\bar{\chi}} (q_N^c \Omega + \chi^c \Delta_0) N + \text{h.c.}$$

$$Q_B(\Delta_0) = -1$$

$$Q_D(\Delta_0) = -1/2$$

$$Q_B(\chi \Delta_0^* N) = 1$$

$$Q_D(\chi \Delta_0^* N) = 1$$

$$\Rightarrow U(1)_{B-D}$$

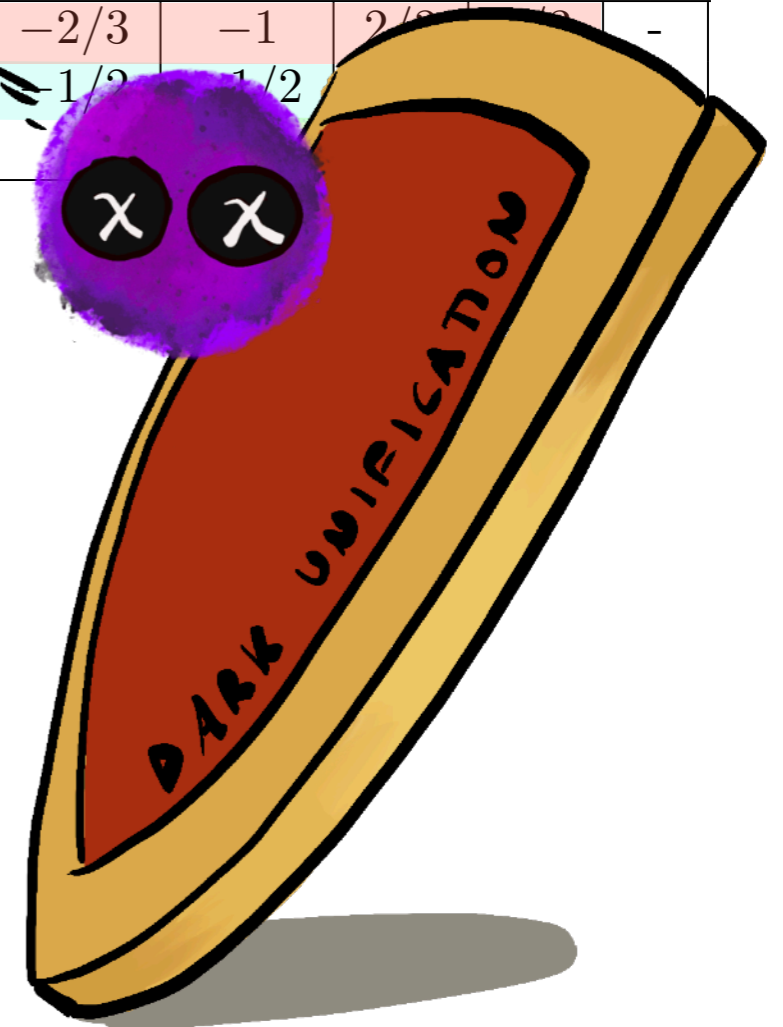

# Darko-Baryo-Genesis

⇒ Asymmetry generation ingredients: [Sakharov, 1967]

**1** Violation of  $U(1)_B$  and  $U(1)_D$



$$(Y_{\Delta B} =) Y_{\Delta D} \simeq \text{Br}(N \rightarrow \Delta_0^* \chi) \epsilon_{\text{CP}}^N \frac{T_{\text{RH}}^N}{M_N}$$



⇒  $U(1)_{B-D}$



# Darko-Baryo-Genesis

⇒ Asymmetry generation ingredients:

**1** Violation of  $U(1)_B$  and  $U(1)_D$

**2** Out-of-equilibrium  $\Gamma_N[T = M_N] < 3H[T = M_N]$

N lifetime (i.e. reheat temperature)

$$T_{\text{RH}}^N \sim \left( \frac{45}{16\pi^3 g_*} \right)^{1/4} \sqrt{\Gamma_N M_{\text{Pl}}}$$

$$\Gamma_N \simeq 6 \times 10^7 \text{ s}^{-1} \left( \frac{|Y_{\text{DN}}|}{10^{-9}} \right)^2 \left( \frac{M_N}{1 \text{ TeV}} \right)$$

$$(Y_{\Delta B} =) Y_{\Delta D} \simeq \text{Br}(N \rightarrow \Delta_0^* \chi) \epsilon_{\text{CP}}^N \frac{T_{\text{RH}}^N}{M_N}$$

N mass

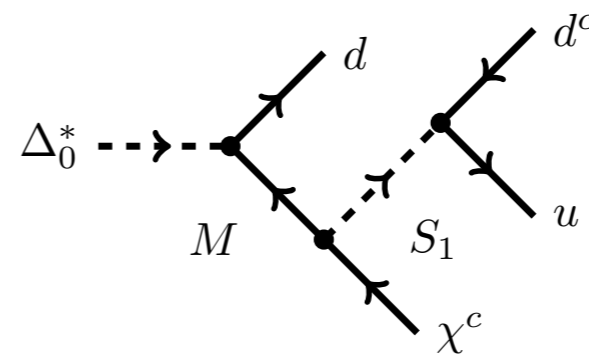
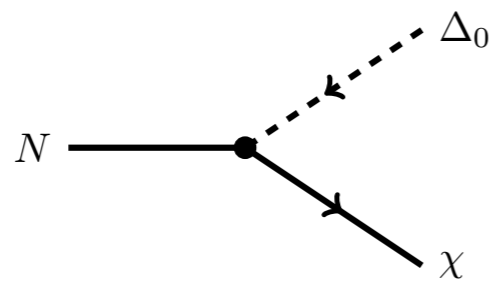

# Darko-Baryo-Genesis

⇒ Asymmetry generation ingredients:

**1** Violation of  $U(1)_B$  and  $U(1)_D$

**2** Out-of-equilibrium  $\Gamma_N[T = M_N] < 3H[T = M_N]$

N lifetime (i.e. reheat temperature)

$$T_{\text{RH}}^N \sim \left( \frac{45}{16\pi^3 g_*} \right)^{1/4} \sqrt{\Gamma_N M_{\text{Pl}}}$$

$$\Gamma_N \simeq 6 \times 10^7 \text{ s}^{-1} \left( \frac{|Y_{\text{DN}}|}{10^{-9}} \right)^2 \left( \frac{M_N}{1 \text{ TeV}} \right)$$

$$(Y_{\Delta B} =) Y_{\Delta D} \simeq \text{Br}(N \rightarrow \Delta_0^* \chi) \epsilon_{\text{CP}}^N \frac{T_{\text{RH}}^N}{M_N}$$

N mass

CP asymmetry

[Falkowski, Ruderman, Volansky, 2011]

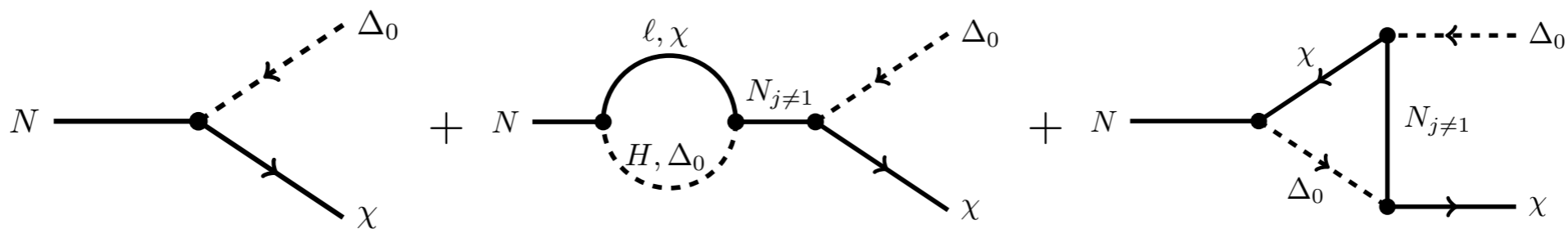

**3** Violation of C and CP (*à la* usual leptogenesis)



# Darko-Baryo-Genesis

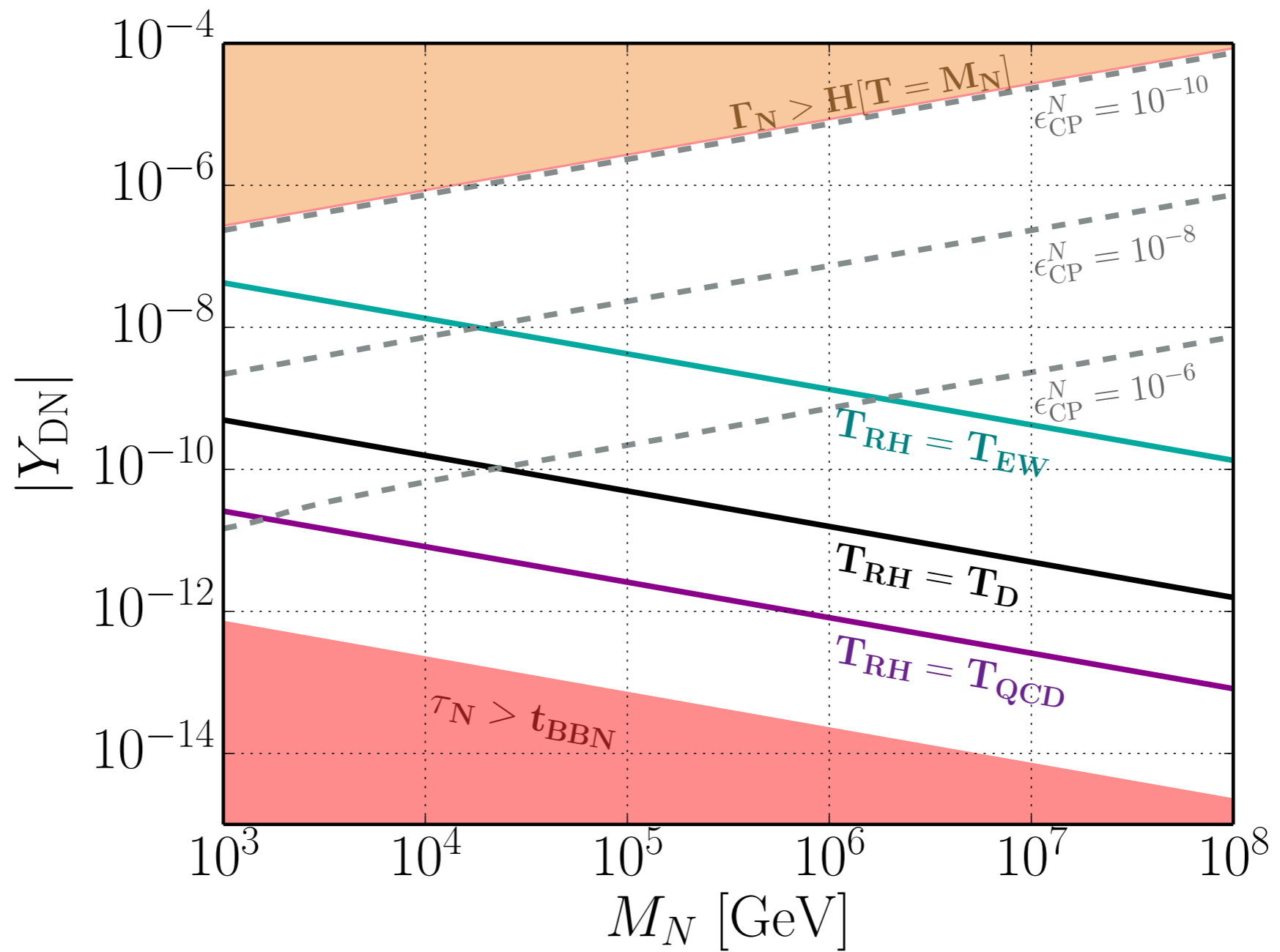
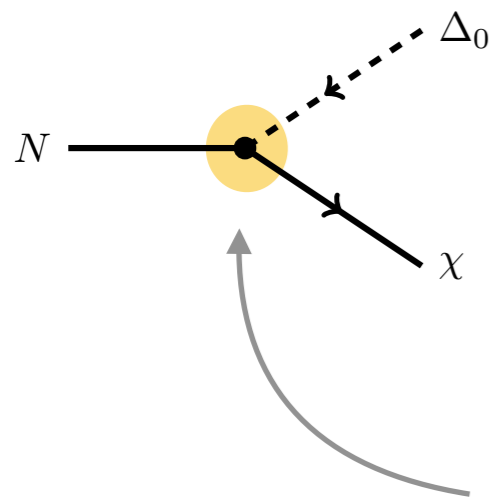

# Darko-Baryo-Genesis

⇒ Relevant parameters:

$$(Y_{\Delta B} =) Y_{\Delta D} \simeq \text{Br}(N \rightarrow \Delta_0^* \chi) \epsilon_{\text{CP}}^N \frac{T_{\text{RH}}^N}{M_N}$$

⇒ Cosmology tells us:

$$\frac{\Omega_D}{\Omega_B} = \frac{Y_{\Delta D} m_\rho}{Y_{\Delta B} m_p} \stackrel{\text{U}(1)_{B-D}}{\sim} 5$$

[Francis, Hudspith, Lewis, Tulin, 2008]  
 $m_\rho \sim 2.5 \Lambda_D$

$m_p \sim 3 \Lambda_{\text{QCD}}$





# Darko-Baryo-Genesis

⇒ Relevant parameters

$$(Y_{\Delta B} =) Y_{\Delta D} \simeq \text{Br}(N \rightarrow \Delta_0^* \chi) \epsilon_{\text{CP}}^N \frac{T_{\text{RH}}^N}{M_N}$$

⇒ Cosmology tells us:

$$\frac{\Omega_D}{\Omega_B} = \frac{Y_{\Delta D} m_\rho}{Y_{\Delta B} m_p} \stackrel{\text{U}(1)_{B-D}}{\sim} 5$$

[Francis, Hudspith, Lewis, Tulin, 2008]  
 $m_\rho \sim 2.5 \Lambda_D$   
 $m_p \sim 3 \Lambda_{\text{QCD}}$

$$\Rightarrow \Lambda_D \sim 6 \Lambda_{\text{QCD}}$$

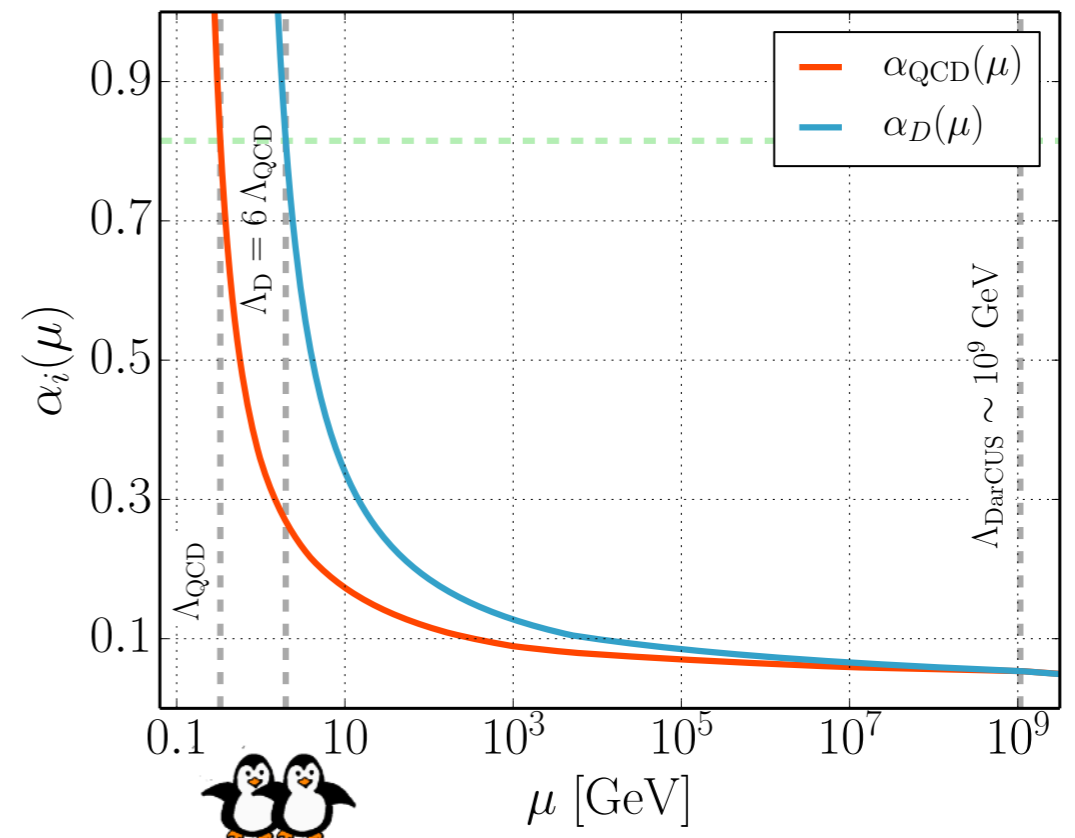

# Annihilation symmetric abundance

[Francis, Hudspith, Lewis, Tulin, 2008]

$$m_\eta < m_\rho \quad (\forall m_\chi < \Lambda_D)$$

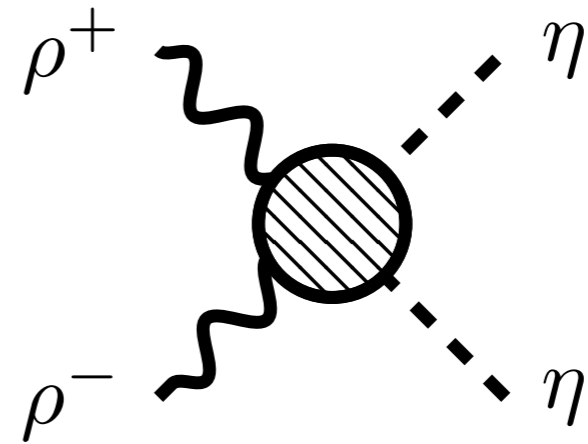

[Case “6” in Dan’s talk on Tuesday]

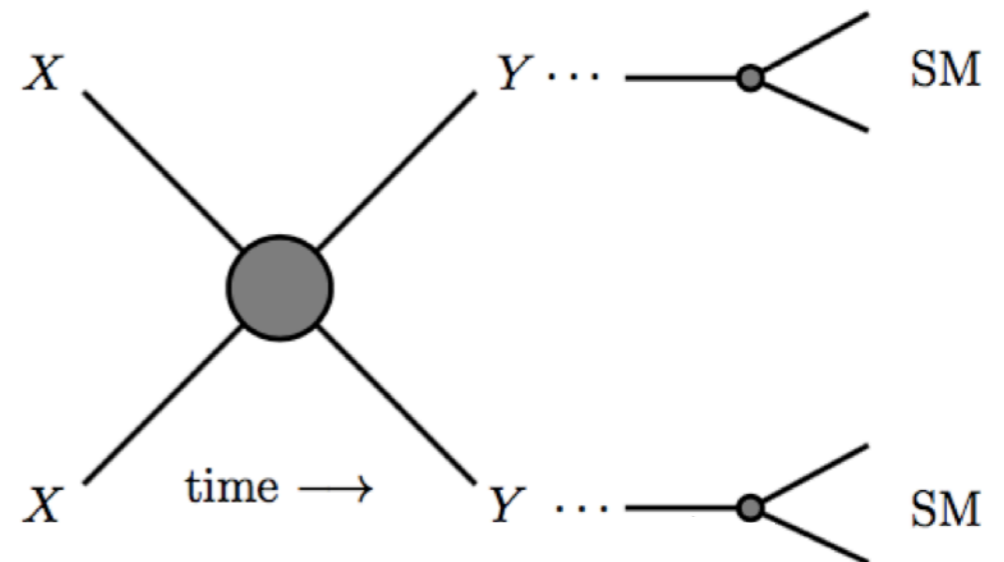

# Annihilation symmetric abundance

[Francis, Hudspith, Lewis, Tulin, 2008]

$$m_\eta < m_\rho \quad (\forall m_\chi < \Lambda_D)$$

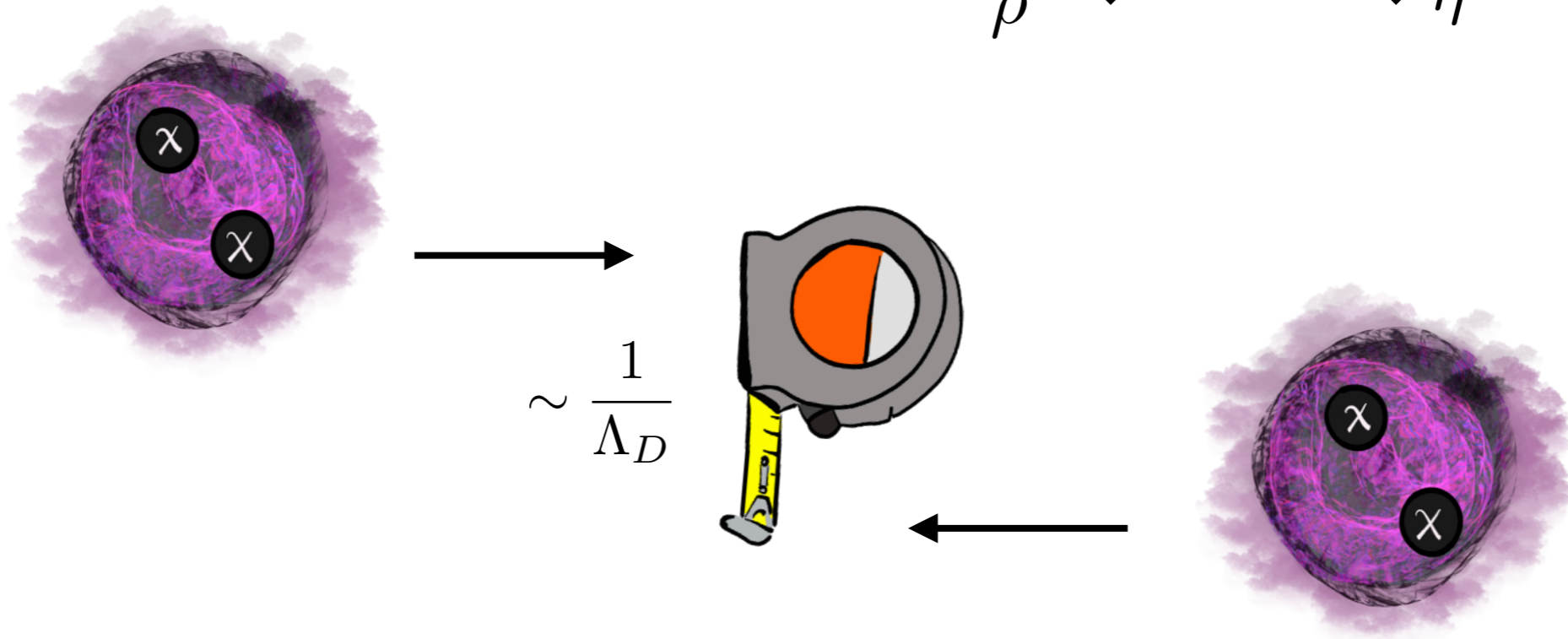

# Annihilation symmetric abundance

[Francis, Hudspith, Lewis, Tulin, 2008]

$$m_\eta < m_\rho \quad (\forall m_\chi < \Lambda_D)$$

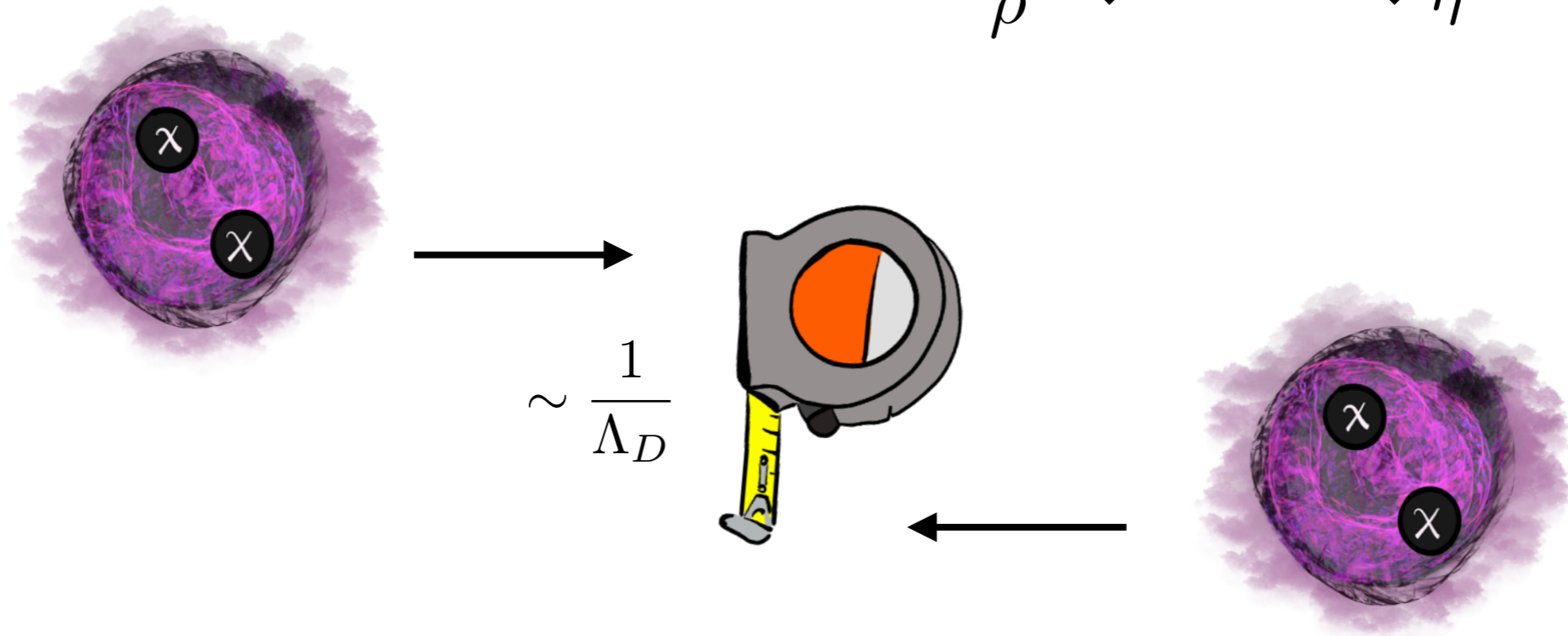
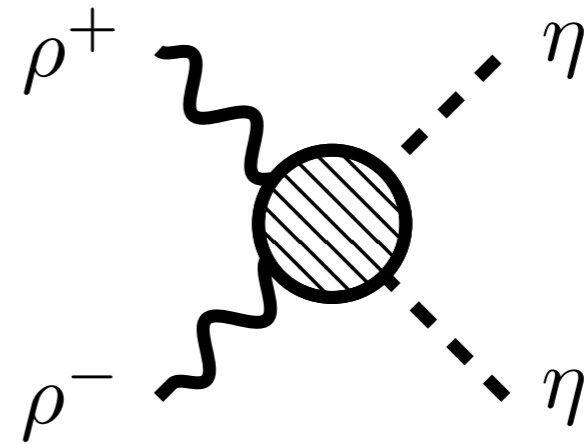

$$\langle \sigma_{\text{ann}} v \rangle \sim \left( \frac{4\pi}{\Lambda_D^2} \right) \left( \frac{3 \Lambda_D}{2 m_\rho} \right)^{1/2} \sim 4 \times 10^{-17} \text{cm}^3 \text{s}^{-1} \left( \frac{2 \text{ GeV}}{\Lambda_D} \right)^2$$



# Dark hadrons

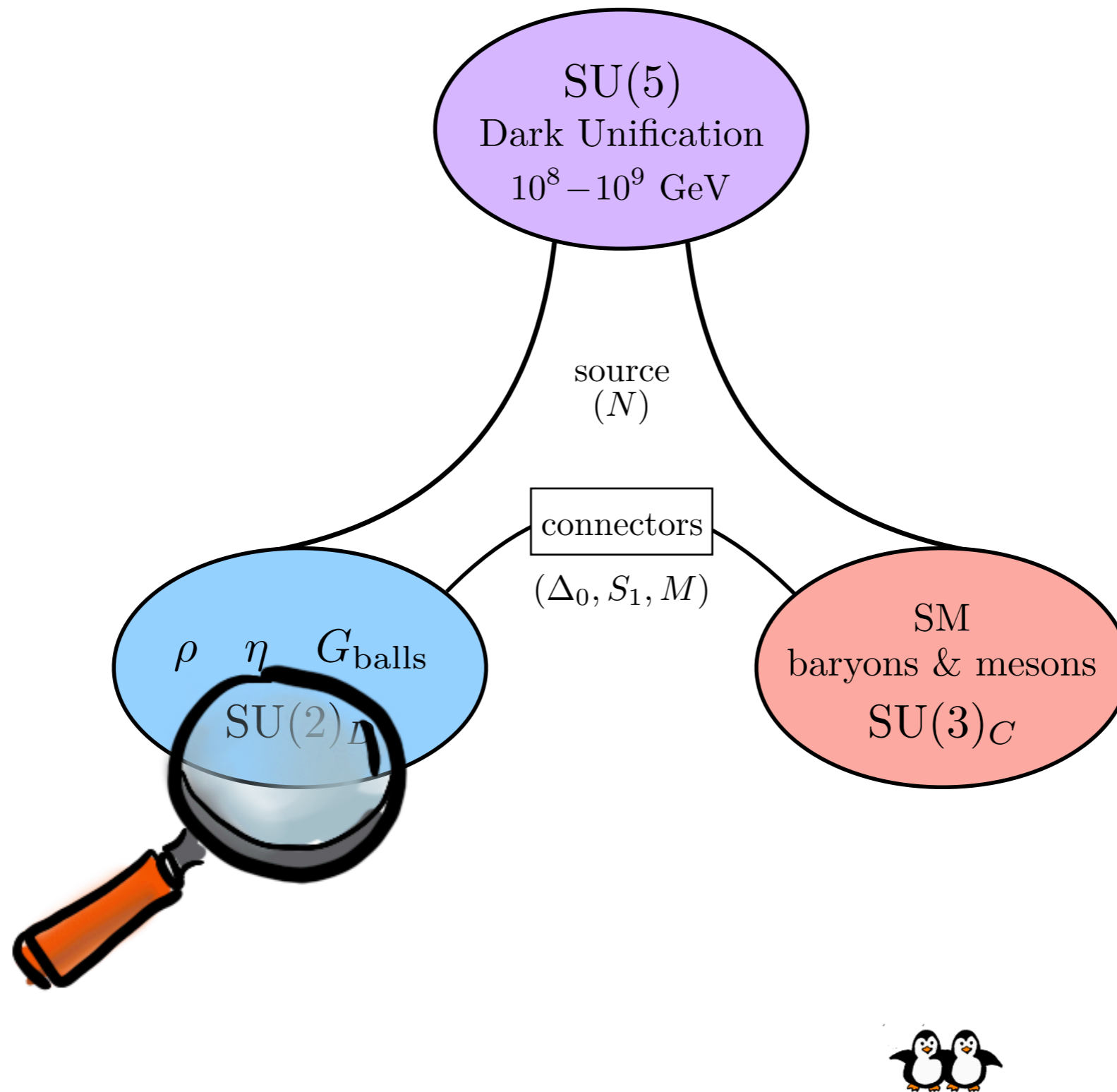

# Dark hadrons

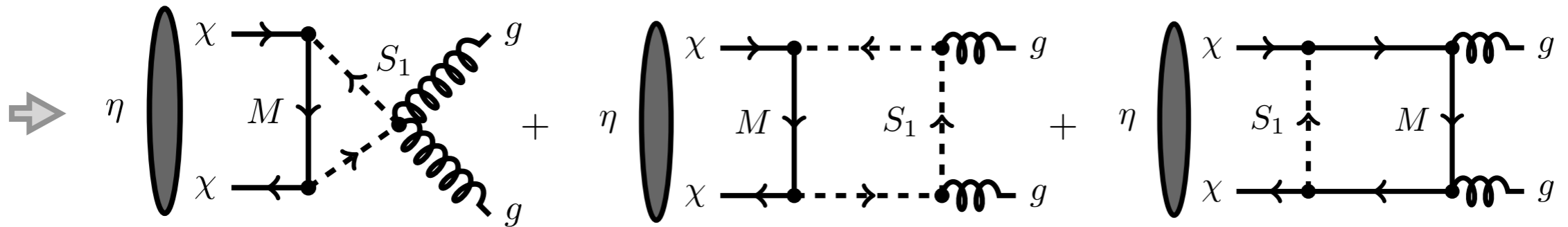

$$\tau_{\eta}^{-1} \sim 8 \text{ s}^{-1} \left( \frac{\alpha_{\text{QCD}}}{0.8} \right)^2 \left( \frac{|Y_{\text{NewQ}}|}{1} \right)^4 \left( \frac{10 \text{ TeV}}{M_{S_1/M}} \right)^6 \left( \frac{m_{\eta}}{4 \text{ GeV}} \right)^7$$



# Dark hadrons

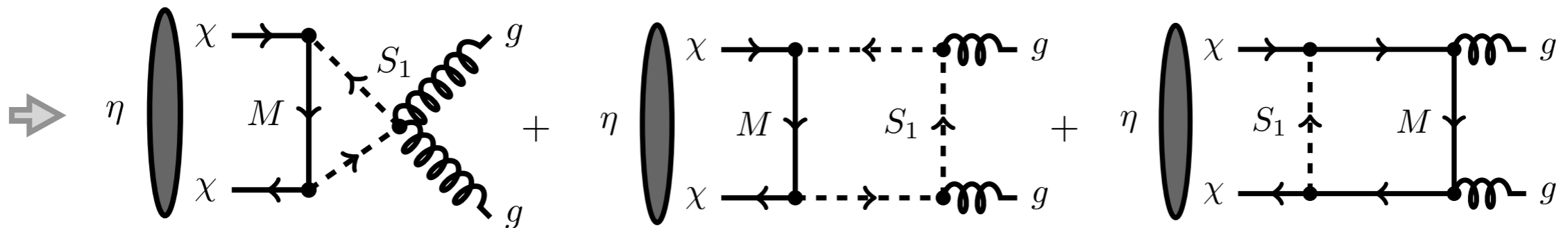

$$\tau_{\eta}^{-1} \sim 8 \text{ s}^{-1} \left( \frac{\alpha_{\text{QCD}}}{0.8} \right)^2 \left( \frac{|Y_{\text{NewQ}}|}{1} \right)^4 \left( \frac{10 \text{ TeV}}{M_{S_1/M}} \right)^6 \left( \frac{m_{\eta}}{4 \text{ GeV}} \right)^7$$

Light connectors  $M$  or  $S_1$   
Early Matter Domination!



# Charged Relics

The (unwanted)  $\mathcal{L}_2$  group

Quirks  $V_{DQ}^\mu$   $\xi$

New quarks  $R_D$

$$R_D \sim (3, 1, \frac{1}{6}, 2)$$





# Charged Relics

The (unwanted)  $\mathcal{L}_2$  group

Quirks  $V_{DQ}^\mu$   $\xi$

New quarks  $R_D$

$$R_D \sim (3, 1, \frac{1}{6}, 2)$$

## Annihilation

[De Luca, Mitridate, Redi, Smirnov, Strumia, 2018]

$$\Omega_{R_D}^{\text{hybrid}} h^2 \sim 3 \times 10^{-7} \left( \frac{M_{R_D}}{3 \text{ TeV}} \right)^{3/2} \left( \frac{g_*}{10} \right)^{1/2}$$

$$\text{CMB: } \Omega_{R_D}^{\text{hybrids}} h^2 < 0.0044$$

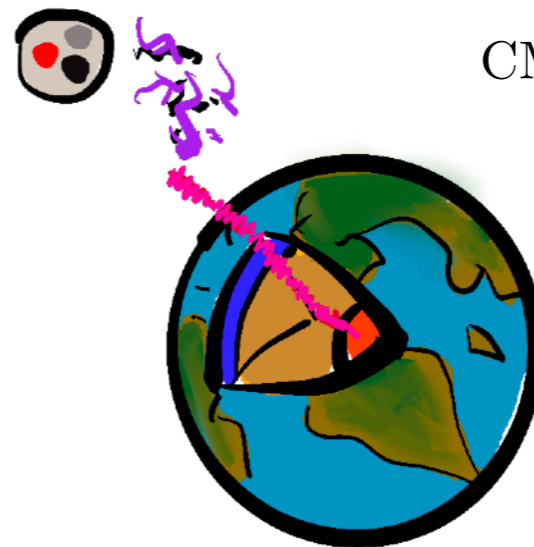

[Perl, Lee, Loomba, 2019]



# Charged Relics

The (unwanted)  $\mathcal{Z}_2$  group

Quirks  $V_{DQ}^\mu$   $\xi$

New quarks  $R_D$

$$R_D \sim (3, 1, \frac{1}{6}, 2)$$

## Inflation

$E$



Lightest  $\mathcal{Z}_2$  field

$T_{\text{inf}}$

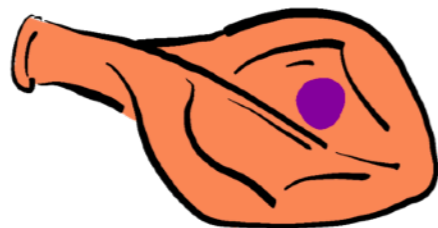

## Annihilation

[De Luca, Mitridate, Redi, Smirnov, Strumia, 2018]

$$\Omega_{R_D}^{\text{hybrid}} h^2 \sim 3 \times 10^{-7} \left( \frac{M_{R_D}}{3 \text{ TeV}} \right)^{3/2} \left( \frac{g_*}{10} \right)^{1/2}$$

CMB:  $\Omega_{R_D}^{\text{hybrids}} h^2 < 0.0044$

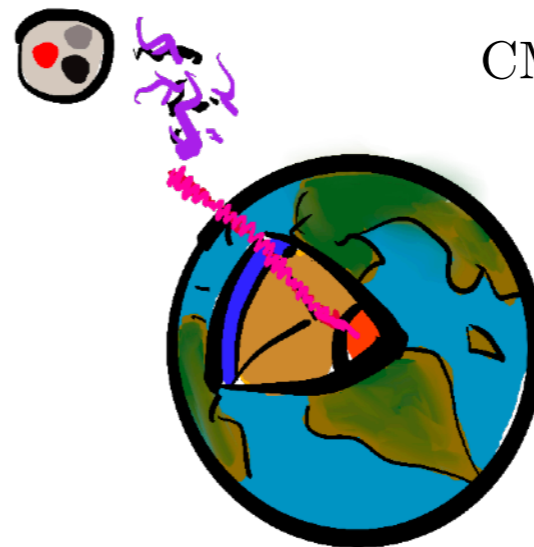

[Perl, Lee, Loomba, 2019]



# Charged Relics

The (unwanted)  $\mathcal{Z}_2$  group

Quirks  $V_{DQ}^\mu$   $\xi$

New quarks  $R_D$

$$R_D \sim (3, 1, \frac{1}{6}, 2)$$

## Inflation

$E$



Lightest  $\mathcal{Z}_2$  field

$T_{\text{inf}}$

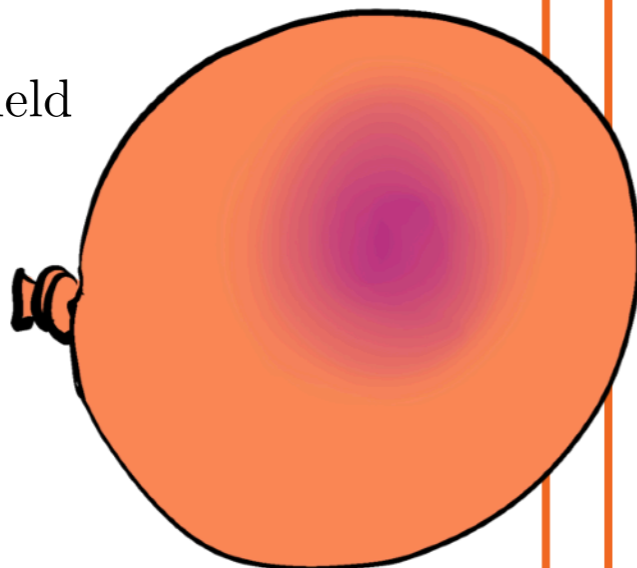
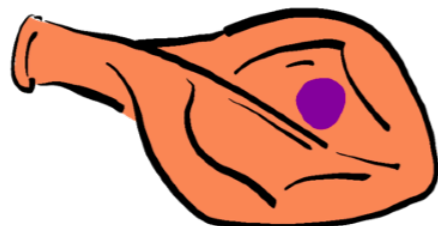

## Annihilation

[De Luca, Mitridate, Redi, Smirnov, Strumia, 2018]

$$\Omega_{R_D}^{\text{hybrid}} h^2 \sim 3 \times 10^{-7} \left( \frac{M_{R_D}}{3 \text{ TeV}} \right)^{3/2} \left( \frac{g_*}{10} \right)^{1/2}$$

CMB:  $\Omega_{R_D}^{\text{hybrids}} h^2 < 0.0044$



[Perl, Lee, Loomba, 2019]



# Signatures



# Phenomenological signatures

⇒ Potential light fields

$$S_1 \quad M \quad (\rho_8) < 10 \text{ TeV}$$

@ colliders

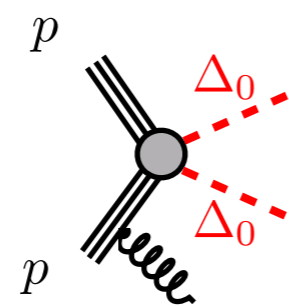
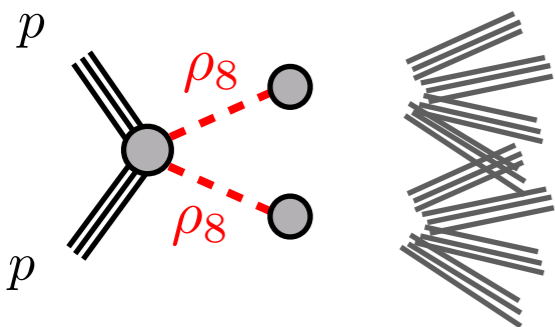
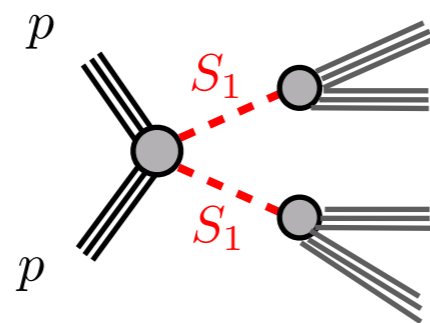
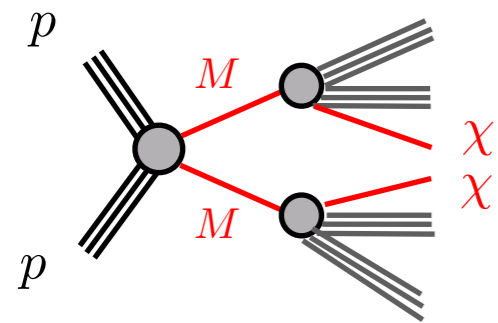

# Phenomenological signatures

⇒ Potential light fields

$$S_1 \quad M \quad (\rho_8) < 10 \text{ TeV}$$

At colliders

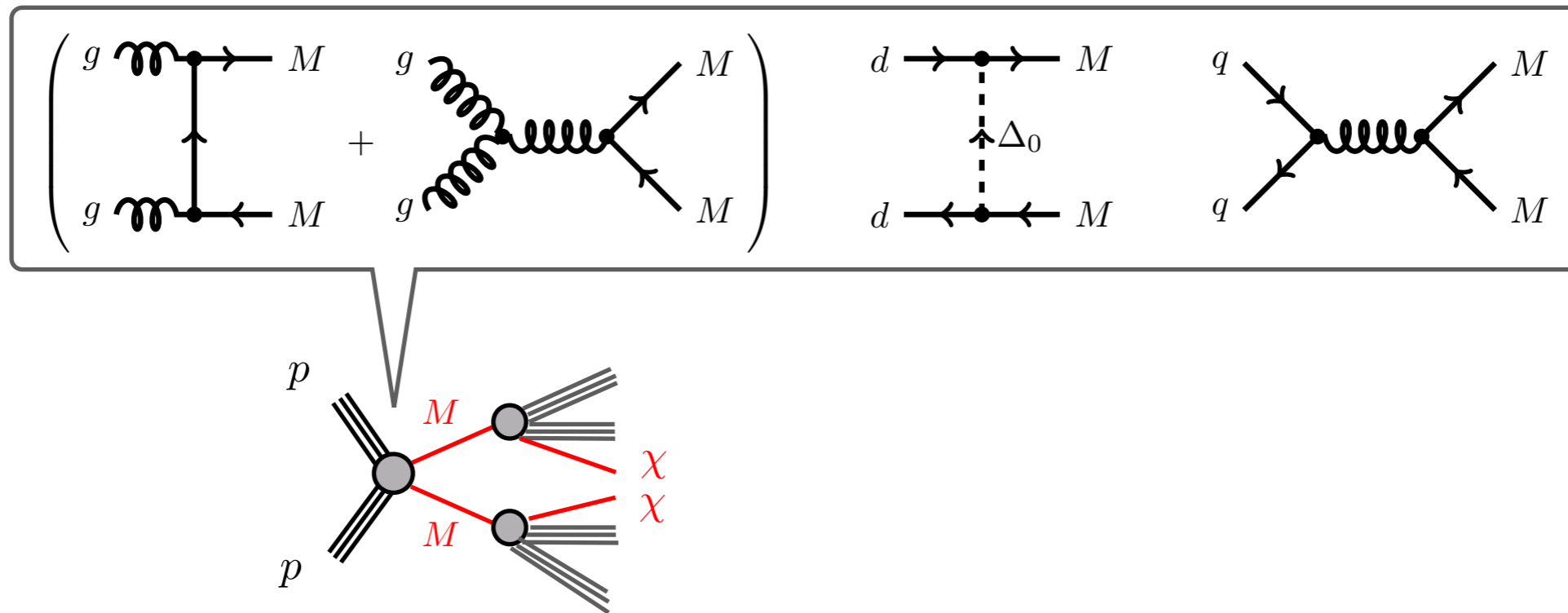

# Phenomenological signatures

⇒ Potential light fields

$$S_1 \quad M \quad (\rho_8) < 10 \text{ TeV}$$

At colliders

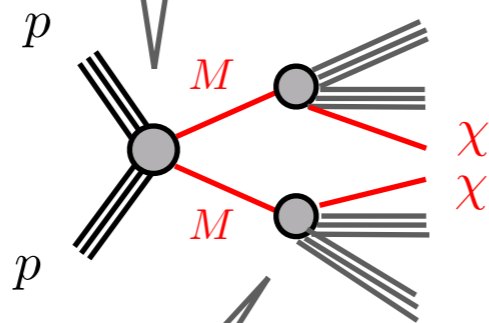
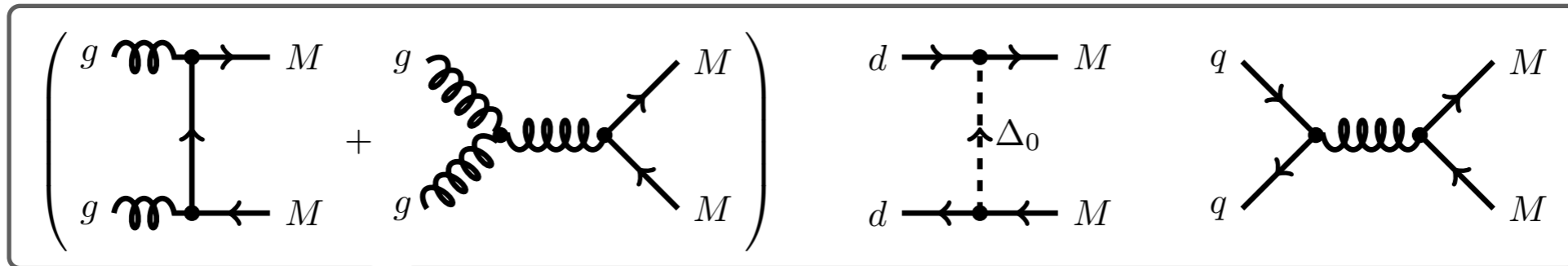

$$M \rightarrow 2 \text{ JETs} + \text{MET}$$

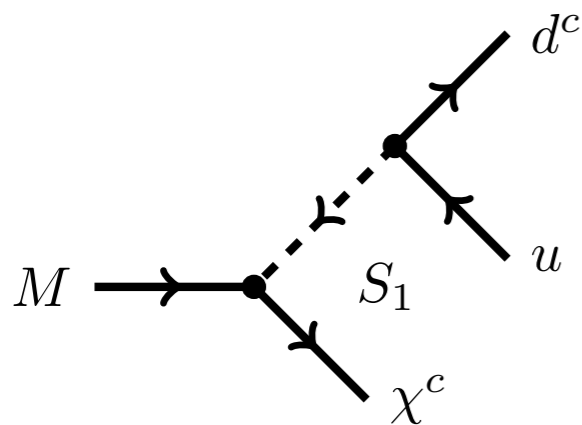

$$\tau_M^{-1} \simeq 9.3 \times 10^{21} \text{ s}^{-1} \left| \frac{Y_{\text{NewQ}}}{1} \right|^2 \left| \frac{Y_{\text{quirks}}}{1} \right|^2 \left( \frac{M_M}{3 \text{ TeV}} \right)^5 \left( \frac{10 \text{ TeV}}{M_{S_1}} \right)^4$$



# Phenomenological signatures

➔ Potential light fields

$$S_1 \quad M \quad (\rho_8) < 10 \text{ TeV}$$

At colliders

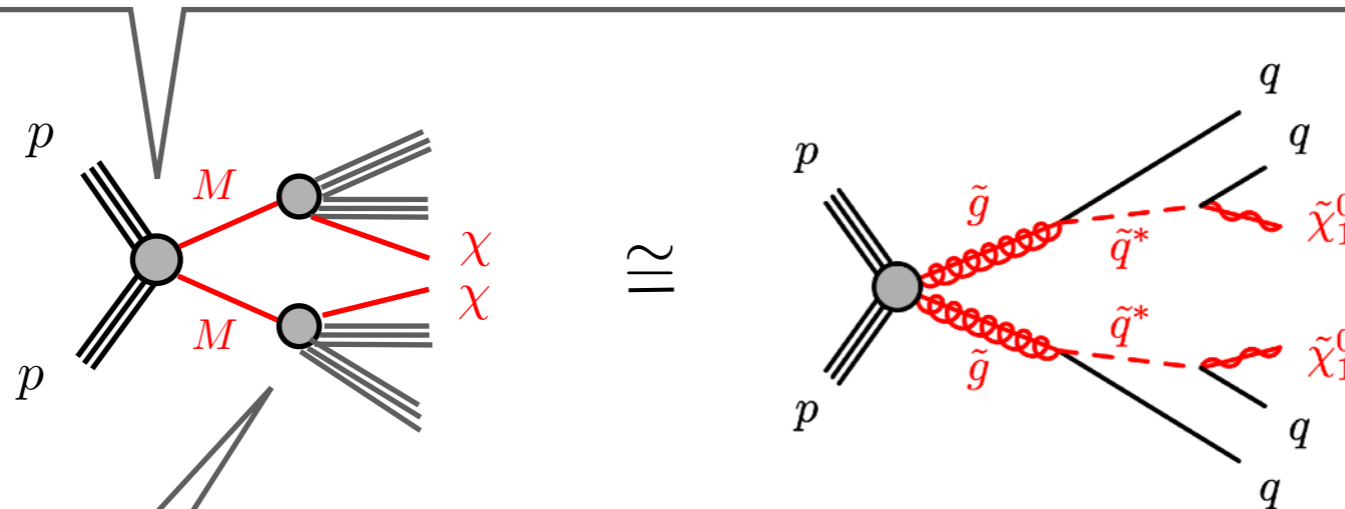
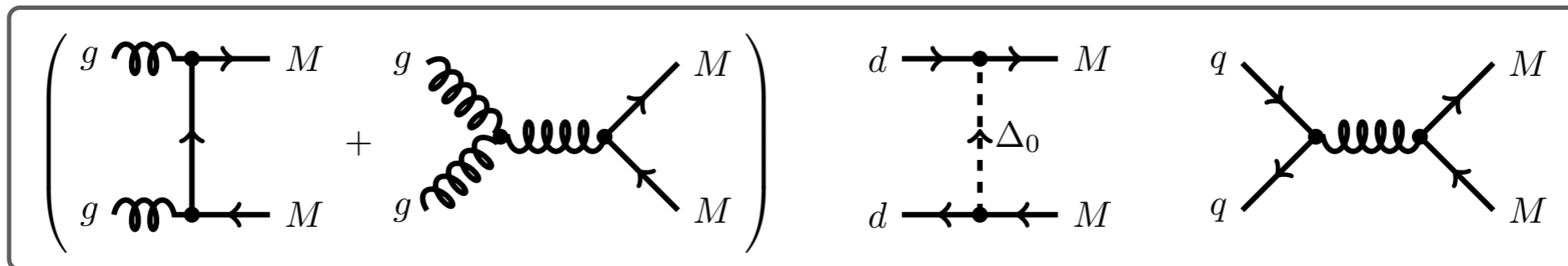

[ATLAS, CMS]

$$M \rightarrow 2 \text{ JETs} + \text{MET}$$

$$m_{\text{gluino}} > 2 - 2.4 \text{ TeV}$$

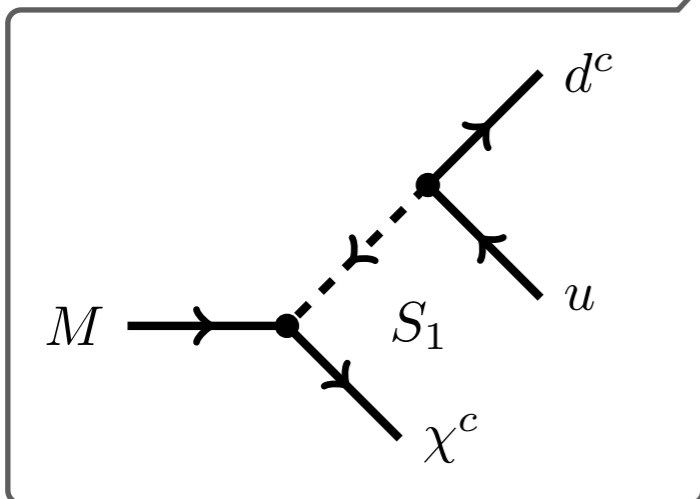

$$\tau_M^{-1} \simeq 9.3 \times 10^{21} \text{ s}^{-1} \left| \frac{Y_{\text{NewQ}}}{1} \right|^2 \left| \frac{Y_{\text{quirks}}}{1} \right|^2 \left( \frac{M_M}{3 \text{ TeV}} \right)^5 \left( \frac{10 \text{ TeV}}{M_{S_1}} \right)^4$$





# Phenomenological signatures

➔ Potential light fields

$$S_1 \quad M \quad (\rho_8) < 10 \text{ TeV}$$

@ colliders

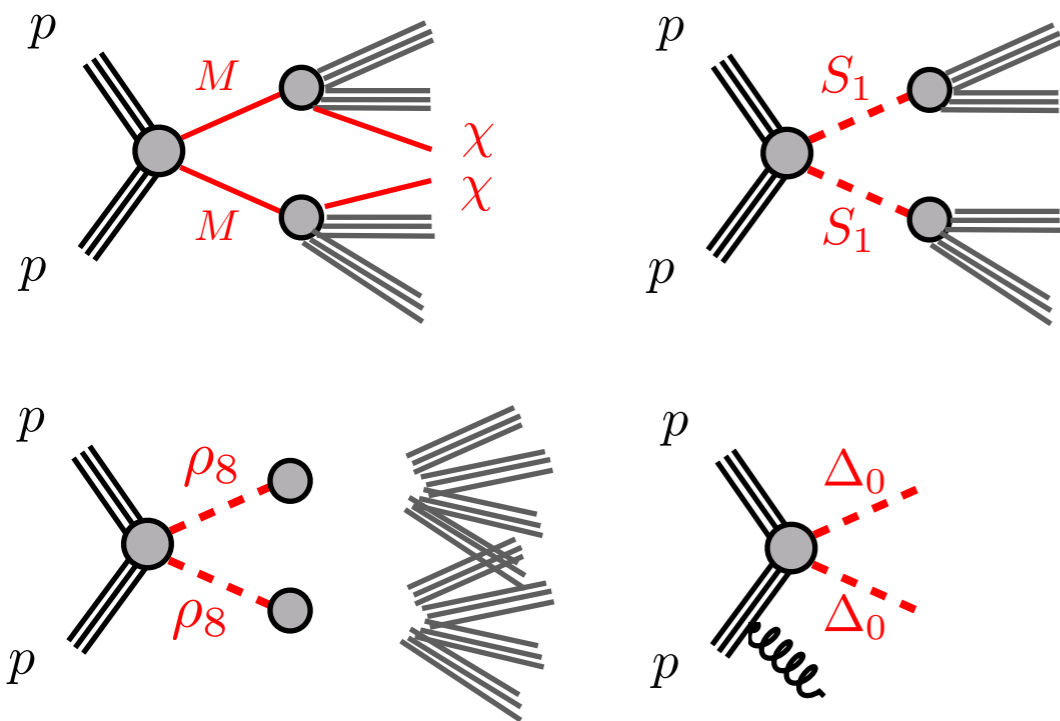

Flavor observables

Meson mixing

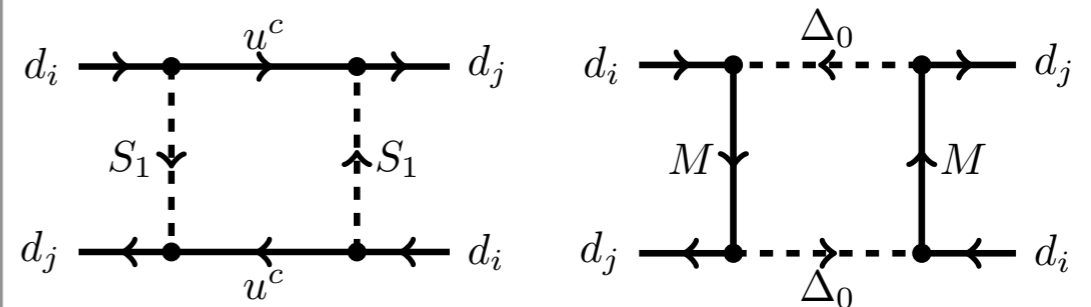

Neutron EDM

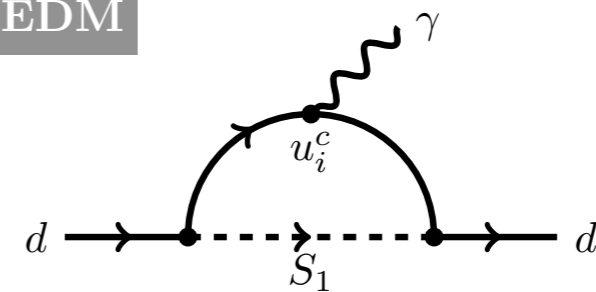

# Astrophysical signatures

DMSI

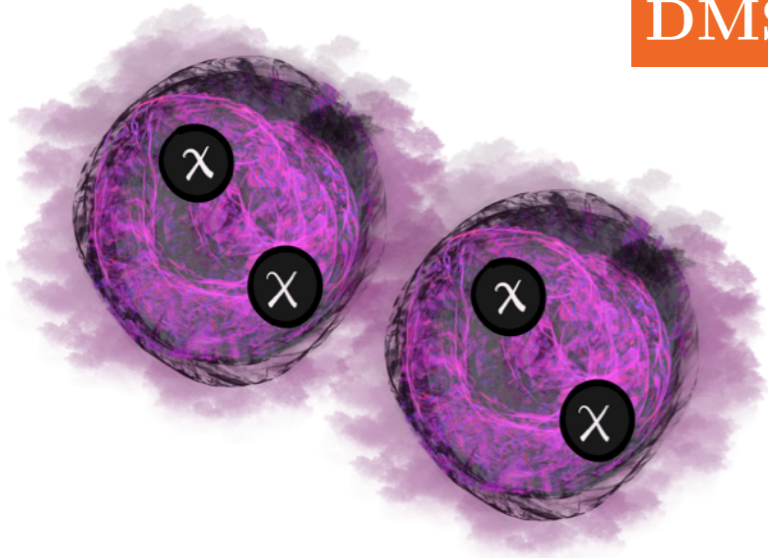

$$\sigma/m_\rho \sim 16\pi/m_\rho^3 \lesssim 1 \text{ cm}^2/\text{g}$$

$$\Rightarrow m_\rho \gtrsim 500 \text{ MeV} \text{ 😊}$$



# Astrophysical signatures

DMSI

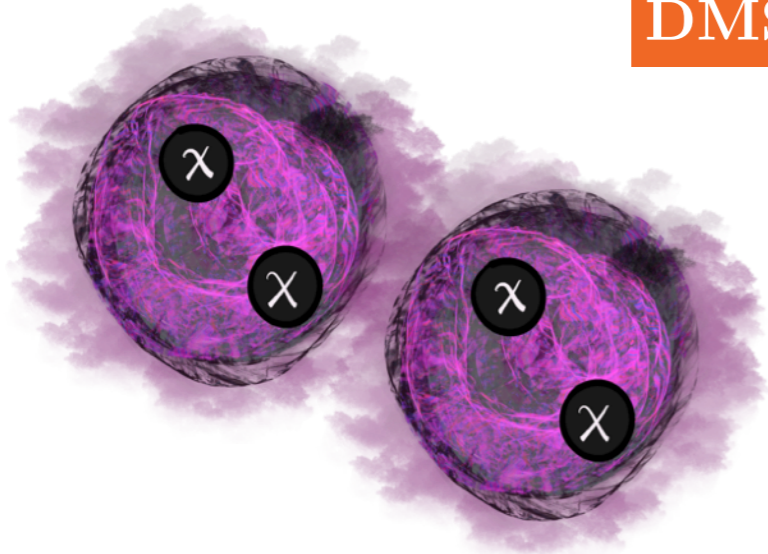

$$\sigma/m_\rho \sim 16\pi/m_\rho^3 \lesssim 1 \text{ cm}^2/\text{g}$$

$$\Rightarrow m_\rho \gtrsim 500 \text{ MeV} \text{ 😊}$$

Nuggets

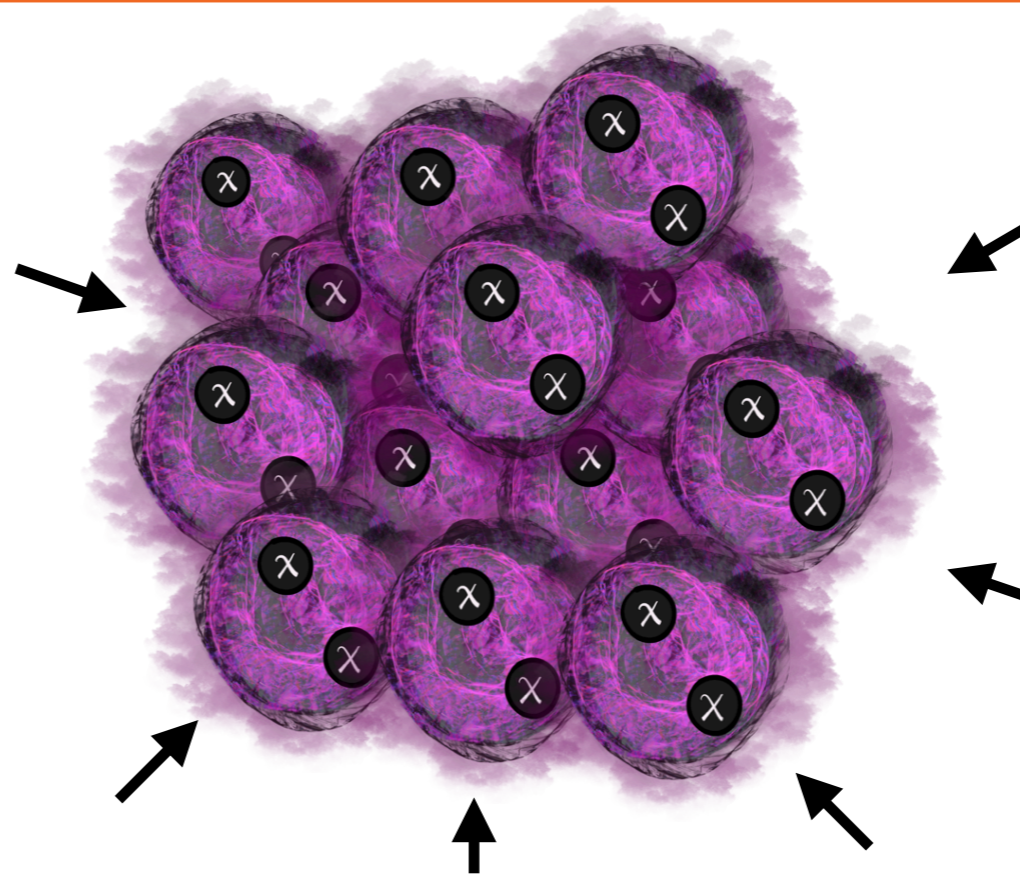

# Astrophysical signatures

DMSI

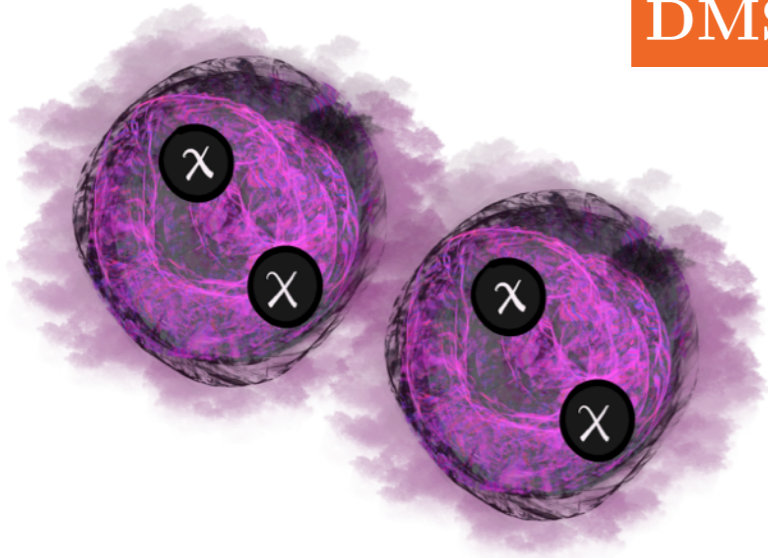

$$\sigma/m_\rho \sim 16\pi/m_\rho^3 \lesssim 1 \text{ cm}^2/\text{g}$$

$$\Rightarrow m_\rho \gtrsim 500 \text{ MeV} \text{ 😊}$$

[Wise, Zhang, 2014]  
[Gresham, Lou, Zurek, 2018]

Nuggets

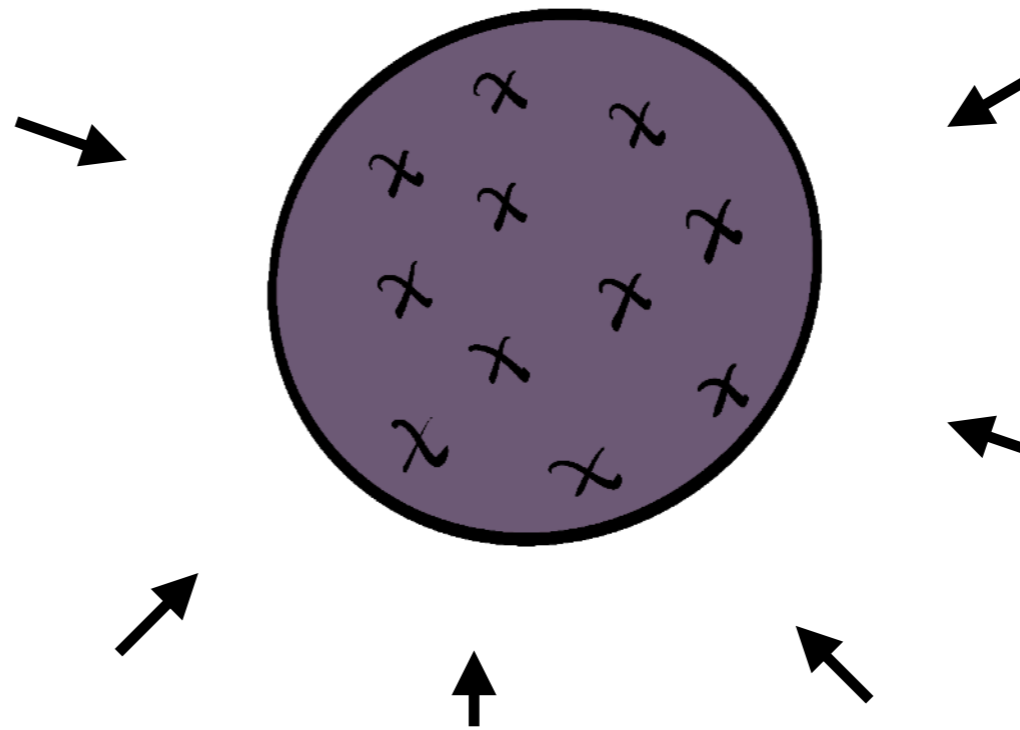

# Astrophysical signatures

**DMSI**

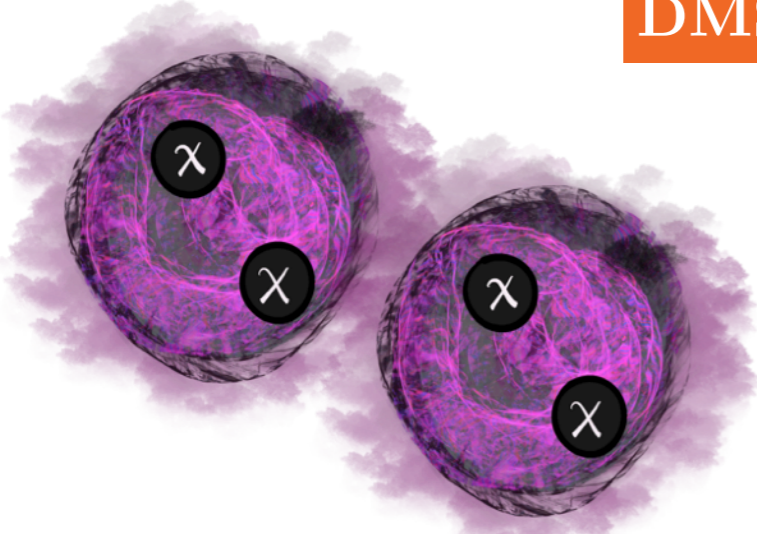

$\sigma/m_\rho \sim 16\pi/m_\rho^3 \lesssim 1 \text{ cm}^2/\text{g}$

$\Rightarrow m_\rho \gtrsim 500 \text{ MeV}$  😊

**Nuggets**

[Wise, Zhang, 2014]  
[Gresham, Lou, Zurek, 2018]

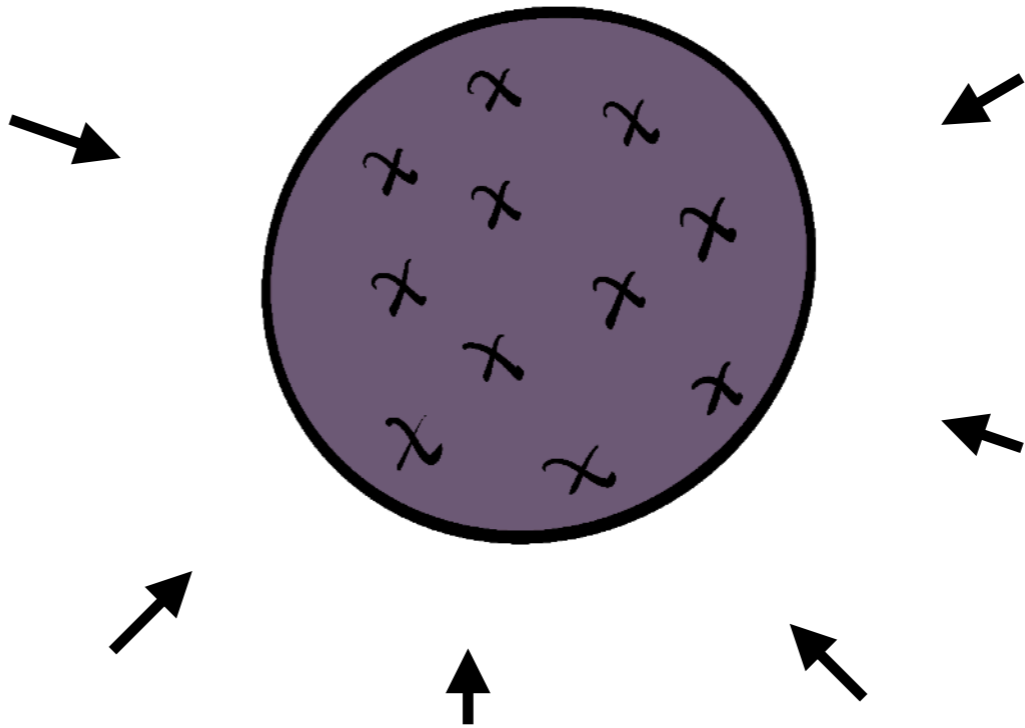

**FOPT??**

$SU(2)_D$   
+ 1 light flavor

**Cosmic strings**

$U(1)_Q \rightarrow \mathbb{Z}_2$   
 $U(1)_5 \otimes U(1)_X \rightarrow U(1)_Y$

**GW**

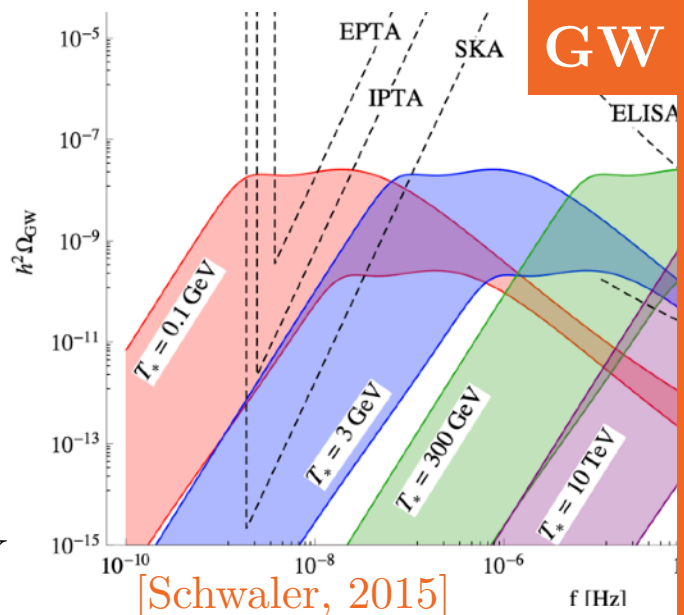

[Schwaller, 2015]





# Astrophysical signatures

**DMSI**

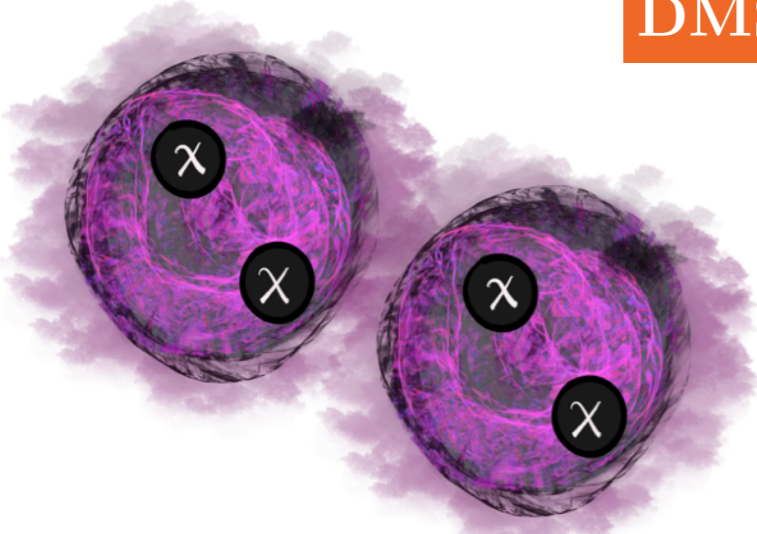

$\sigma/m_\rho \sim 16\pi/m_\rho^3 \lesssim 1 \text{ cm}^2/\text{g}$   
 $\Rightarrow m_\rho \gtrsim 500 \text{ MeV}$  😊

[Wise, Zhang, 2014]  
 [Gresham, Lou, Zurek, 2018]

**Nuggets**

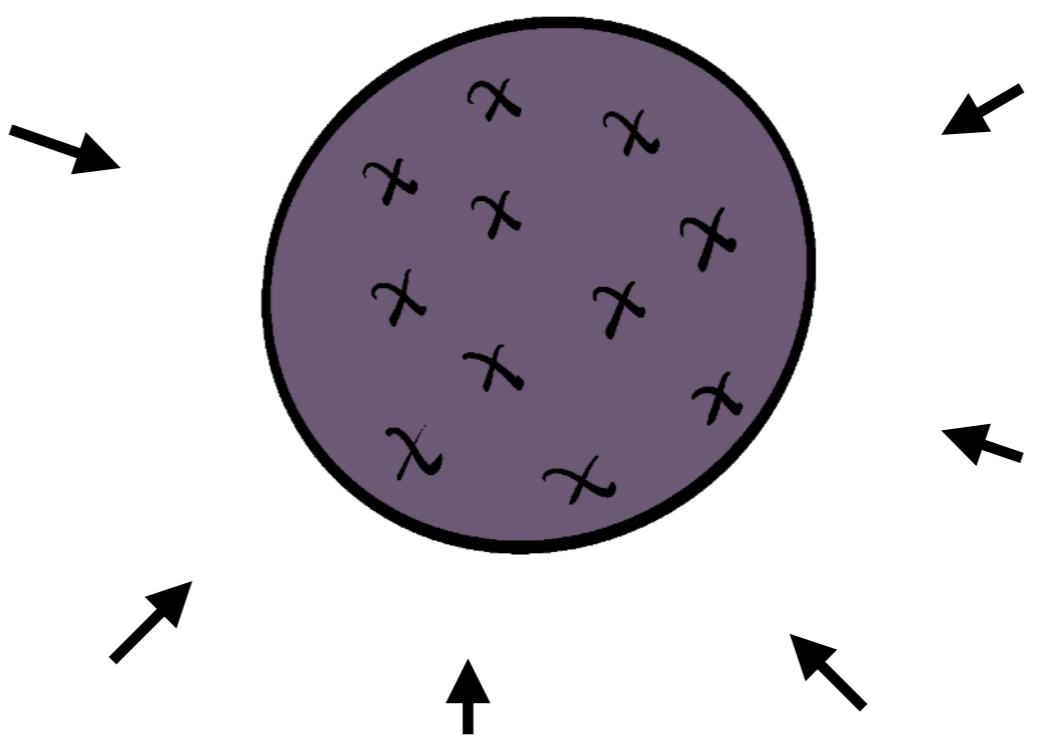

**FOPT??**  
 $SU(2)_D$   
 + 1 light flavor

**Cosmic strings**  
 $U(1)_Q \rightarrow \mathbb{Z}_2$   
 $U(1)_5 \otimes U(1)_X \rightarrow U(1)_Y$

**GW**

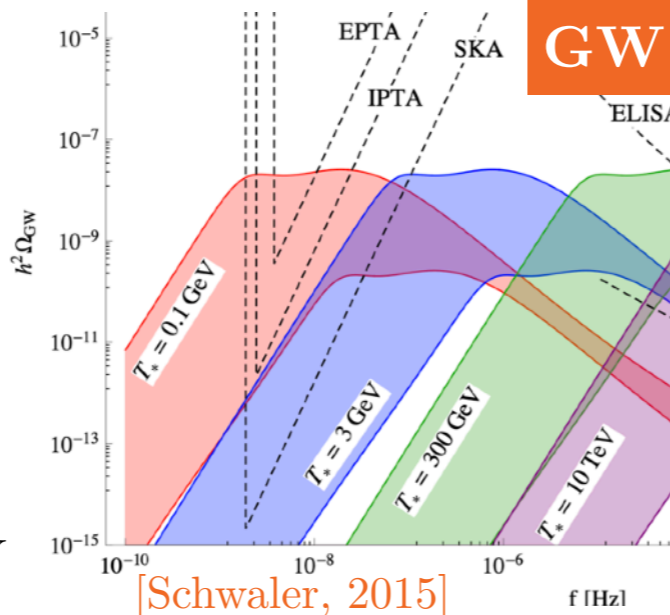

[Schwaller, 2015]

**EMD**

The lightest dark hadron ( $\eta, G_{\text{ball}}$ )

[Lee, Mitridate, Trickle, Zurek, 2019]

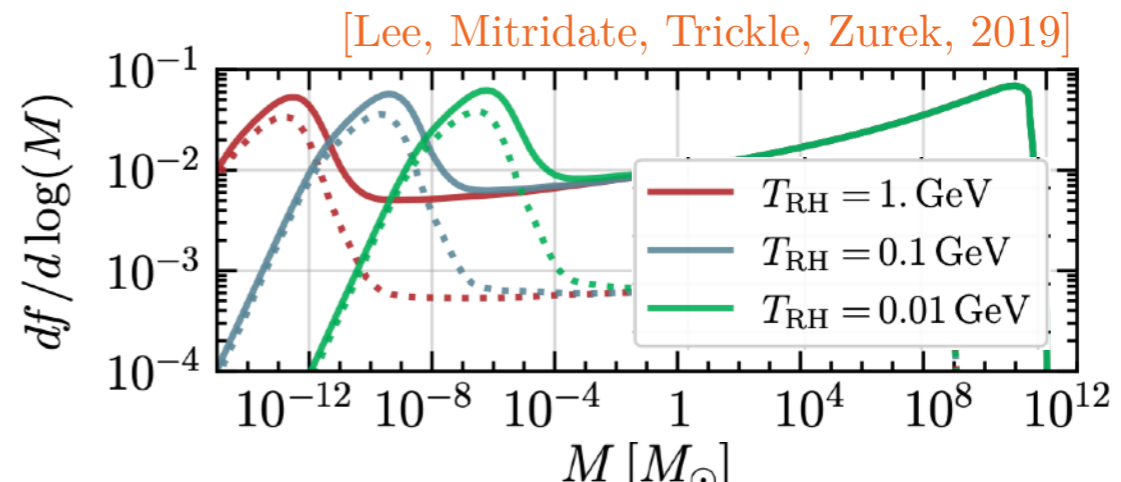

# Cast of Characters



# Main Characters

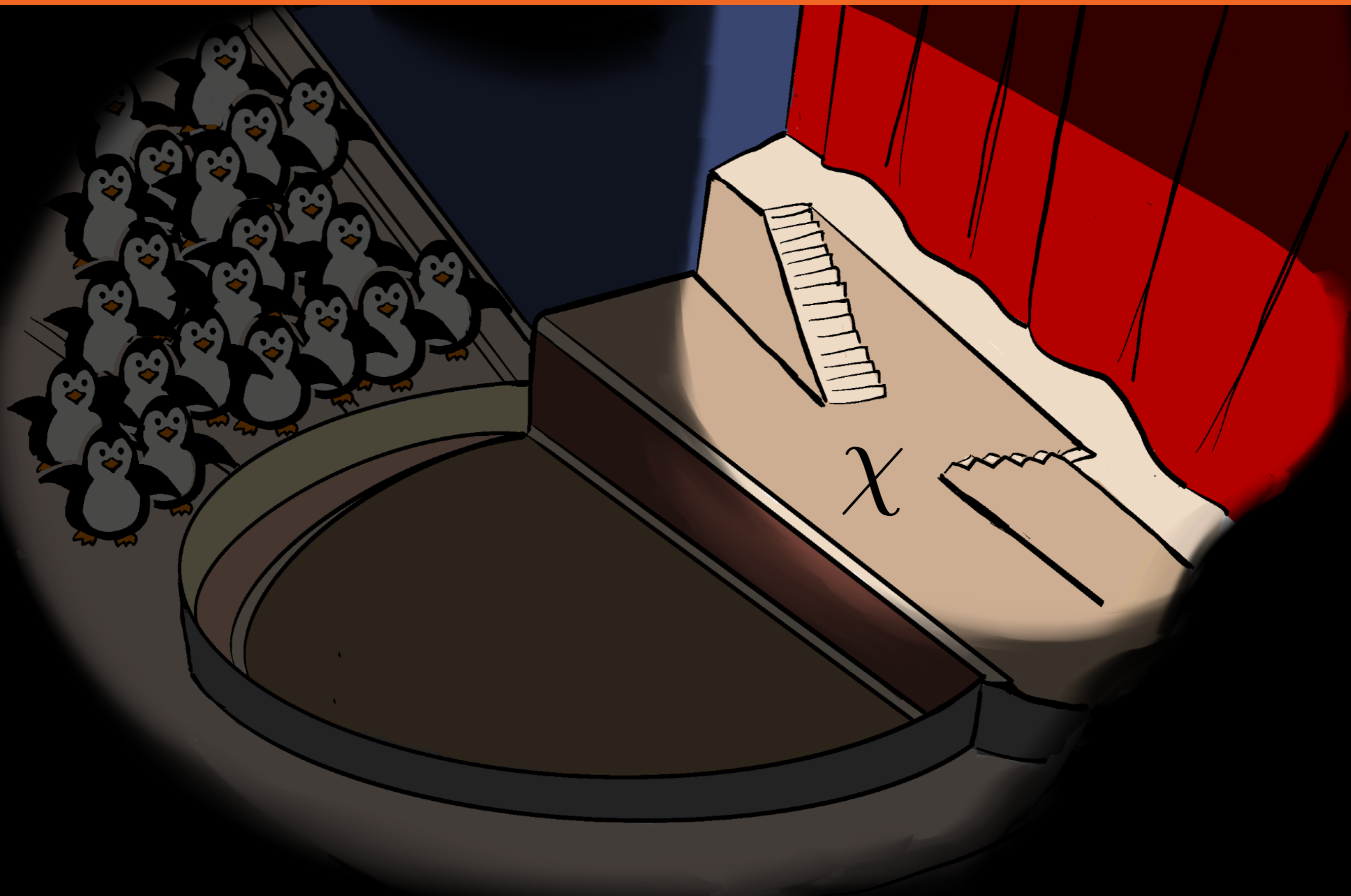



# Main Characters

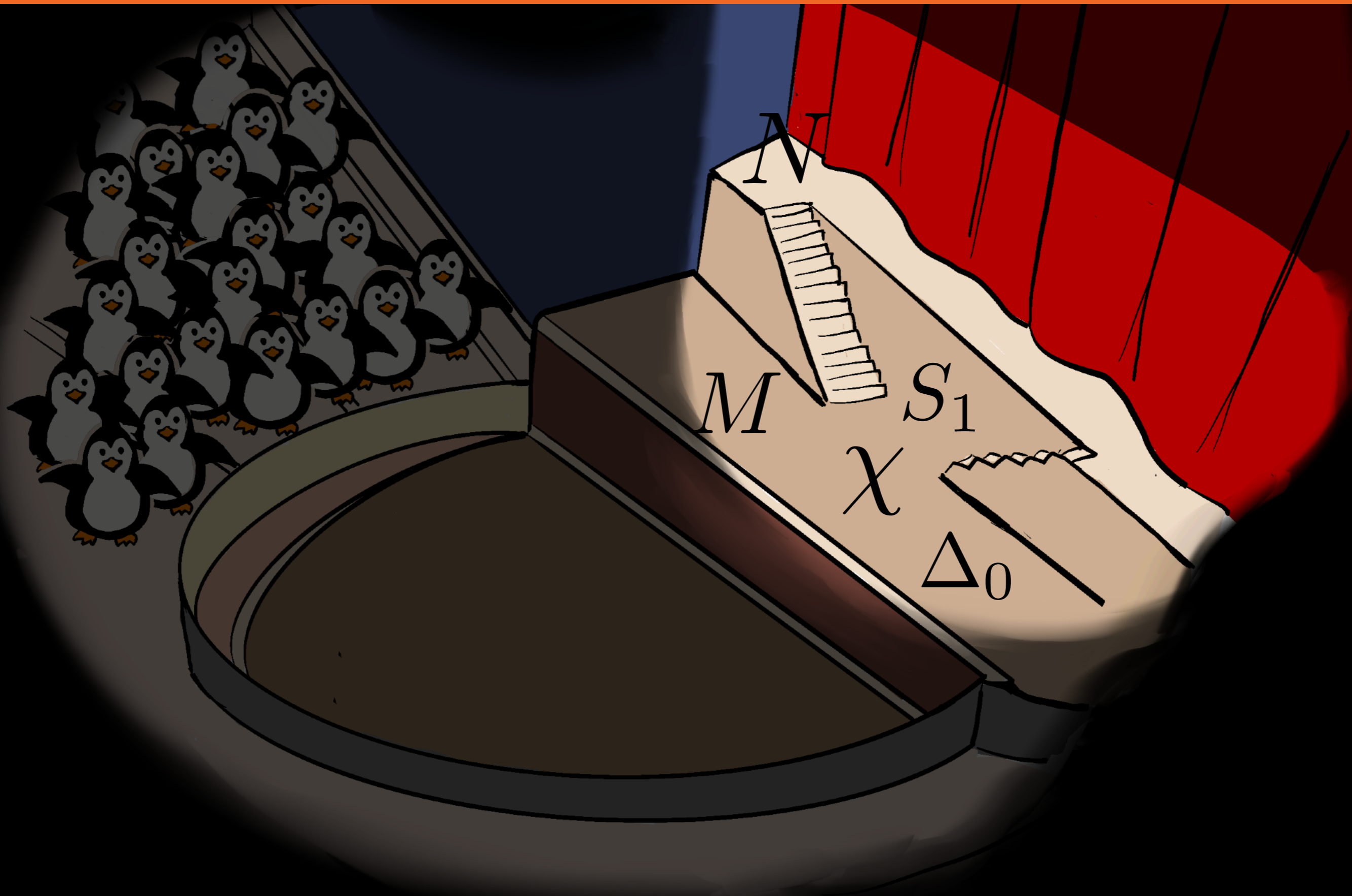

# Supporting Cast

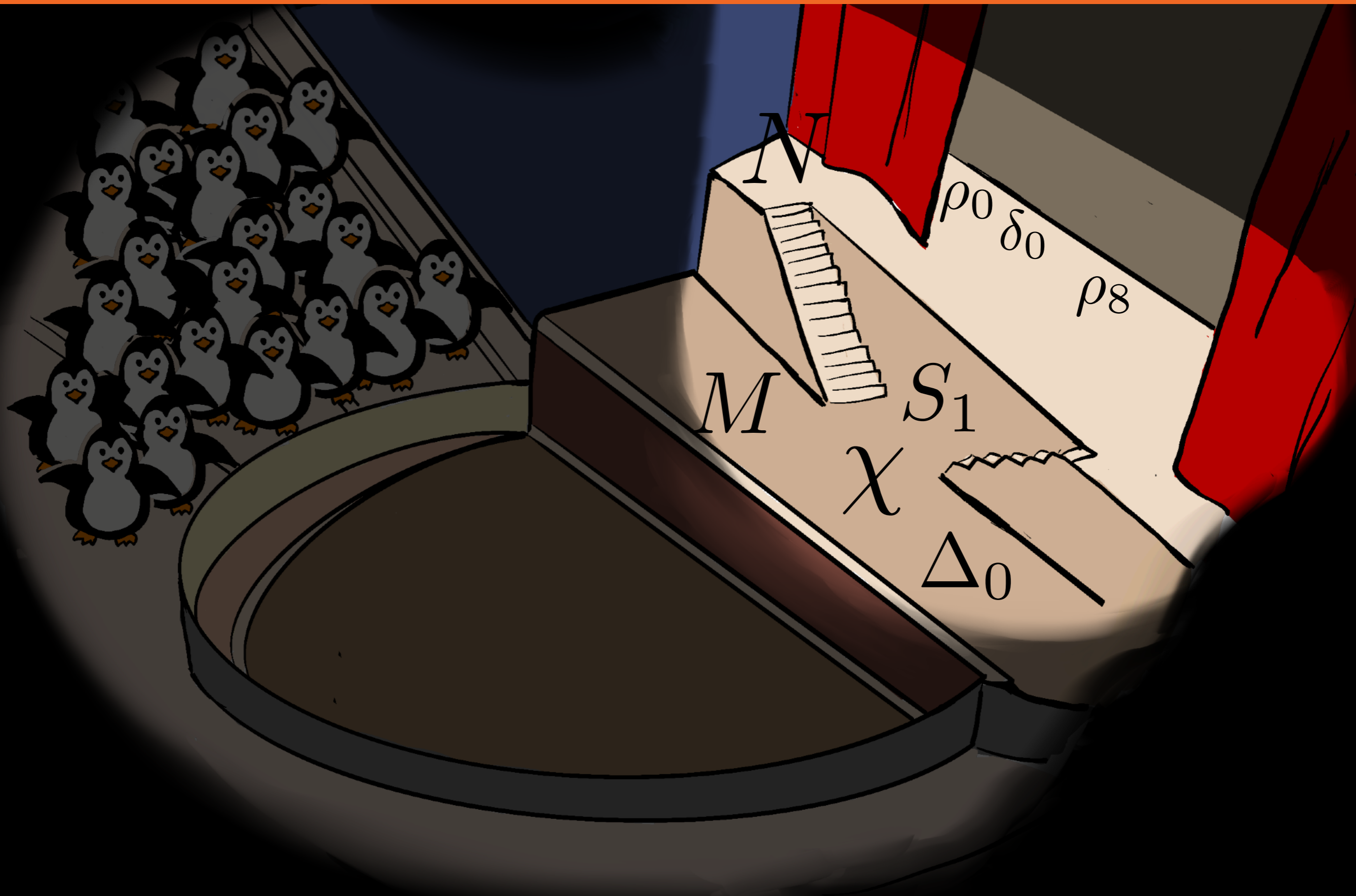

# Chorus

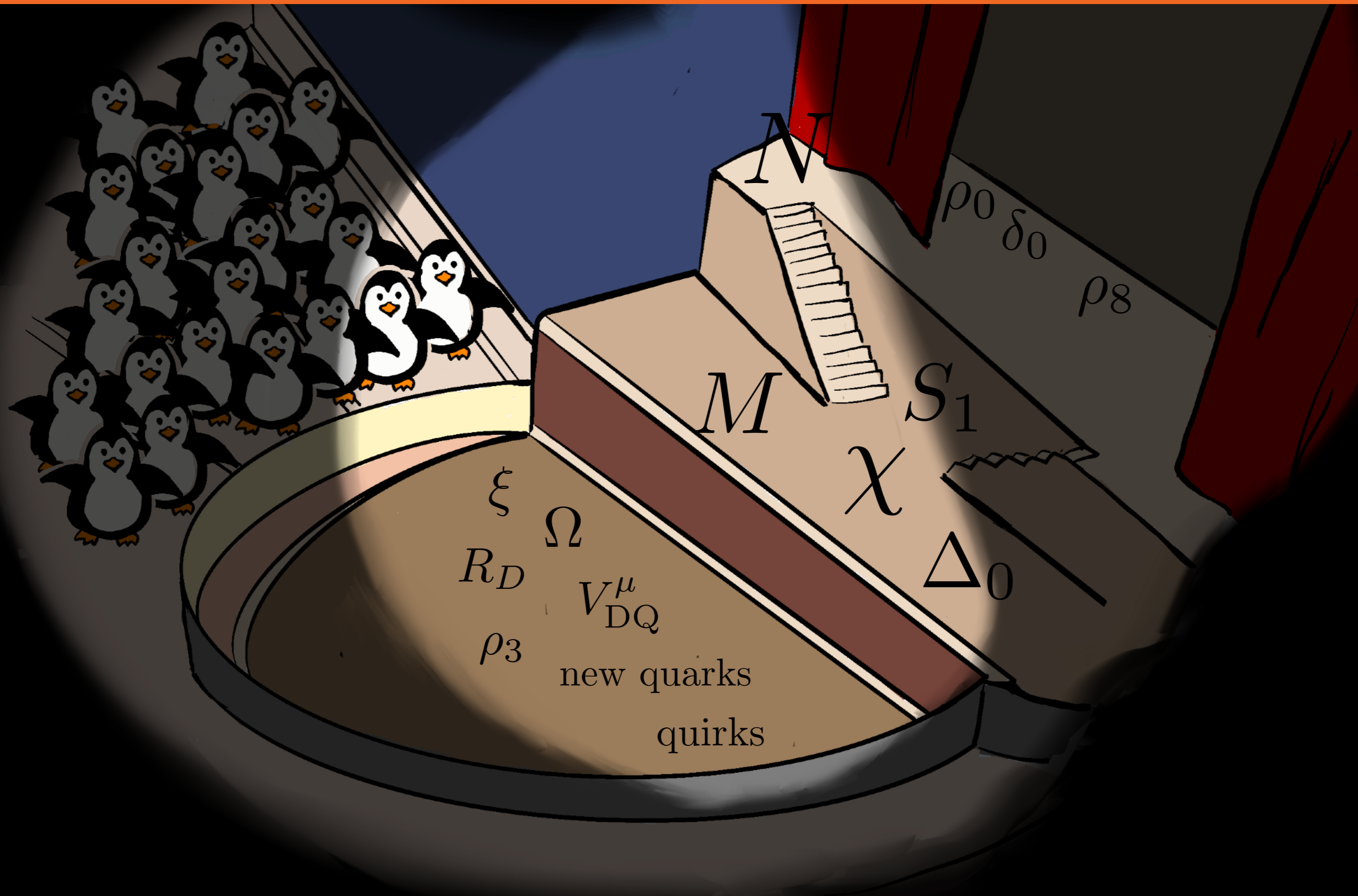

# Towards Grand Unification

$$SU(7) \supset SU(5) \otimes SU(2)_L \otimes U(1)_7 \supset \mathcal{G}_{\text{SM}} \otimes SU(2)_D$$

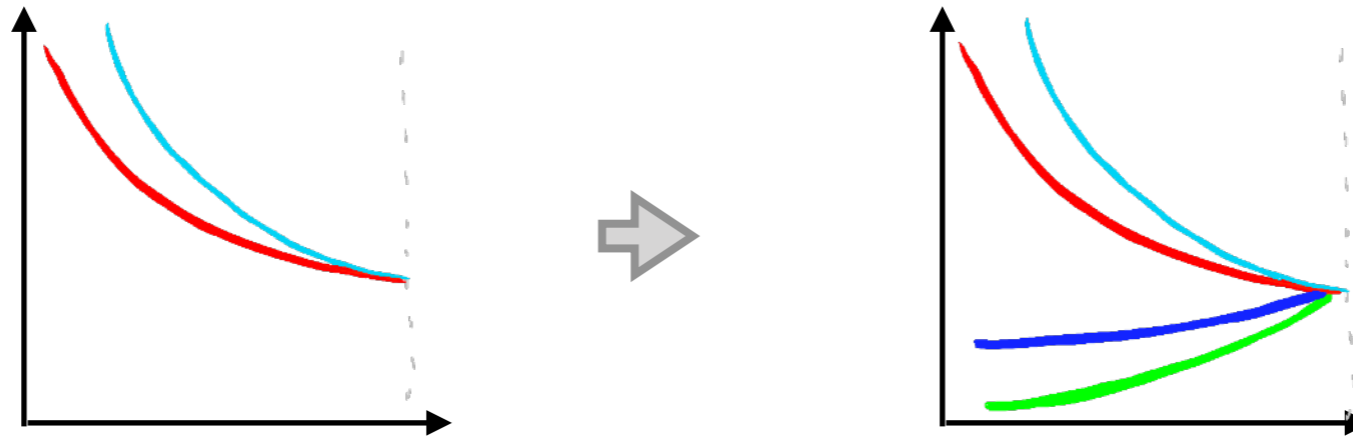

# Towards Grand Unification

$$SU(7) \supset SU(5) \otimes SU(2)_L \otimes U(1)_7 \supset \mathcal{G}_{SM} \otimes SU(2)_D$$

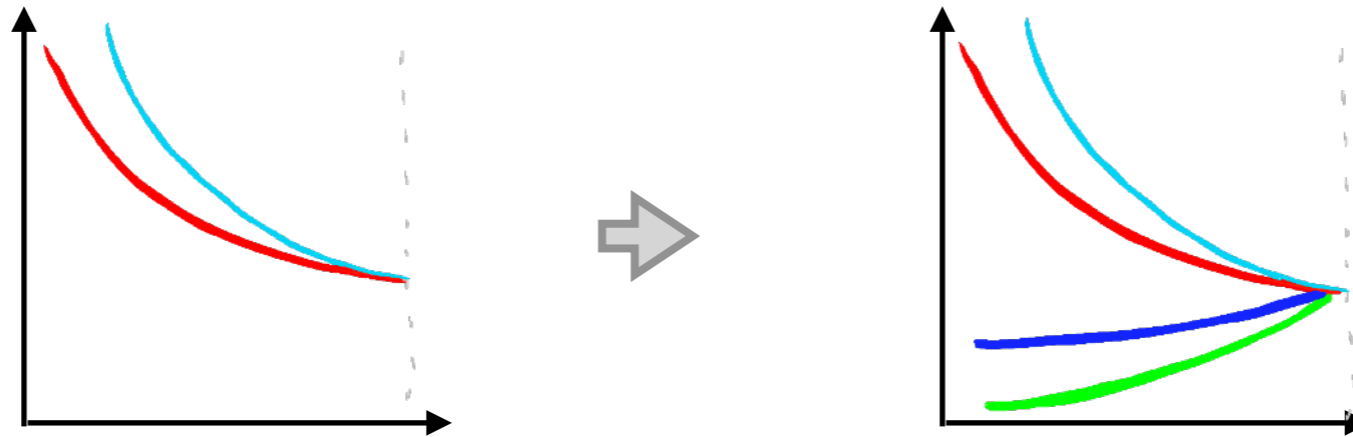

$$SU(2)_L \otimes U(1)_Y \rightarrow U(1)_{em} \quad \Rightarrow \quad 7_H \sim \begin{pmatrix} S_1^* \\ \Delta_0 \\ \text{---} \\ H \end{pmatrix}$$

⇒ Minimal matter content (Embedding of the SM):

$$\bar{7} = \begin{pmatrix} d^c \\ \chi \\ \text{---} \\ \ell \end{pmatrix} \quad \text{and} \quad 21 = \left( \begin{array}{cc|c} u^c & M & q \\ -M^T & N & \Psi_2 \\ \text{---} & \text{---} & \text{---} \\ -q^T & -\Psi_2^T & e^c \end{array} \right)$$





# Towards Grand Unification

$$SU(7) \supset SU(5) \otimes SU(2)_L \otimes U(1)_7 \supset \mathcal{G}_{SM} \otimes SU(2)_D$$

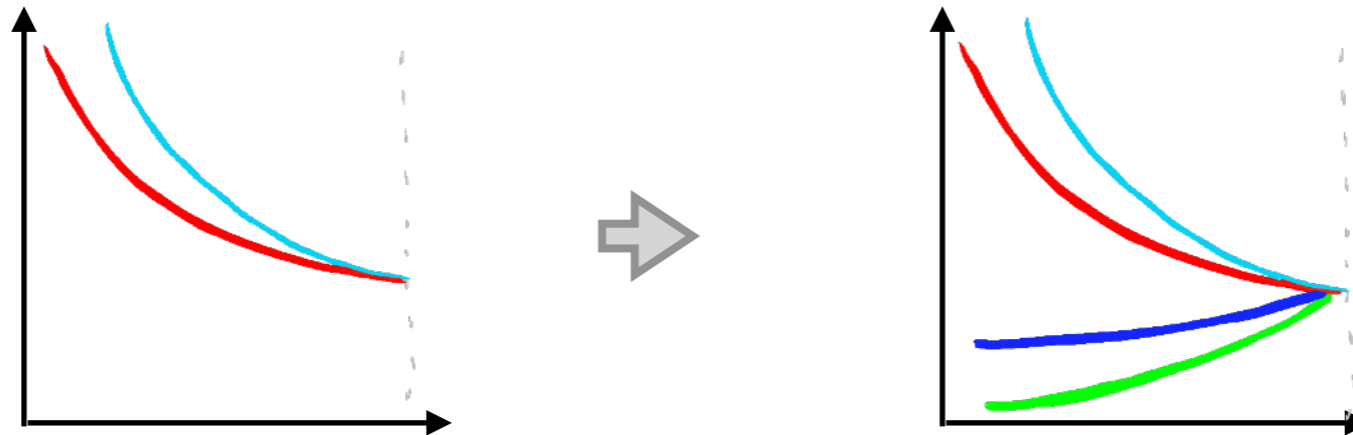

$$SU(2)_L \otimes U(1)_Y \rightarrow U(1)_{em} \quad \Rightarrow \quad 7_H \sim \begin{pmatrix} S_1^* \\ \Delta_0 \\ \text{---} \\ H \end{pmatrix}$$

⇒ Minimal matter content (Embedding of the SM):

$$\bar{7} = \begin{pmatrix} d^c \\ \chi \\ \text{---} \\ \ell \end{pmatrix} \quad \text{and} \quad 21 = \left( \begin{array}{cc|c} u^c & M & q \\ -M^T & N & \Psi_2 \\ \text{---} & \text{---} & \text{---} \\ -q^T & -\Psi_2^T & e^c \end{array} \right)$$



# Towards Grand Unification

$$\mathrm{SU}(7) \supset \mathrm{SU}(5) \otimes \mathrm{SU}(2)_L \otimes \mathrm{U}(1)_7 \supset \mathcal{G}_{\mathrm{SM}} \otimes \mathrm{SU}(2)_D$$

⇒ Simplest Yukawa interaction:

$$Y_e \bar{7} 21 7_H^*$$

⇒ Minimal matter content (Embedding of the SM):

$$\bar{7} = \begin{pmatrix} d^c \\ \chi \\ \ell \end{pmatrix} \quad 21 = \left( \begin{array}{cc|c} u^c & M & q \\ -M^T & N & \Psi_2 \\ \hline -q^T & -\Psi_2^T & e^c \end{array} \right) \quad 7_H \sim \begin{pmatrix} S_1^* \\ \Delta_0 \\ H \end{pmatrix} \quad 48_H \quad 21_H$$



# Towards Grand Unification

$$SU(7) \supset SU(5) \otimes SU(2)_L \otimes U(1)_7 \supset \mathcal{G}_{SM} \otimes SU(2)_D$$

⇒ Simplest Yukawa interaction:

$$Y_e \bar{7} 21 7_H^*$$

↓ Expand

$$\supset Y_e (d^c u^c S_1 + d^c M \Delta_0^* + \chi M S_1 + \chi N \Delta_0^*)$$

## Darko-Baryo-Genesis

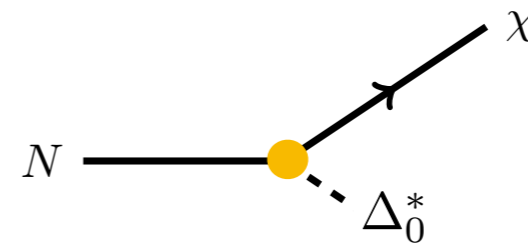

⇒ Minimal matter content (Embedding of the SM):

$$\bar{7} = \begin{pmatrix} d^c \\ \chi \\ \text{---} \\ \ell \end{pmatrix} \quad 21 = \left( \begin{array}{cc|c} u^c & M & q \\ -M^T & N & \Psi_2 \\ \text{---} & \text{---} & \text{---} \\ -q^T & -\Psi_2^T & e^c \end{array} \right)$$

$$7_H \sim \begin{pmatrix} S_1^* \\ \Delta_0 \\ \text{---} \\ H \end{pmatrix} \quad 48_H \quad 21_H$$





# Towards Grand Unification

$$SU(7) \supset SU(5) \otimes SU(2)_L \otimes U(1)_7 \supset \mathcal{G}_{SM} \otimes SU(2)_D$$

⇒ Simplest Yukawa interaction:

$$Y_e \bar{7} 21 7_H^*$$

↓ Expand

$$\supset Y_e (d^c u^c S_1 + d^c M \Delta_0^* + \chi M S_1 + \chi N \Delta_0^*)$$

## Darko-Baryo-Genesis

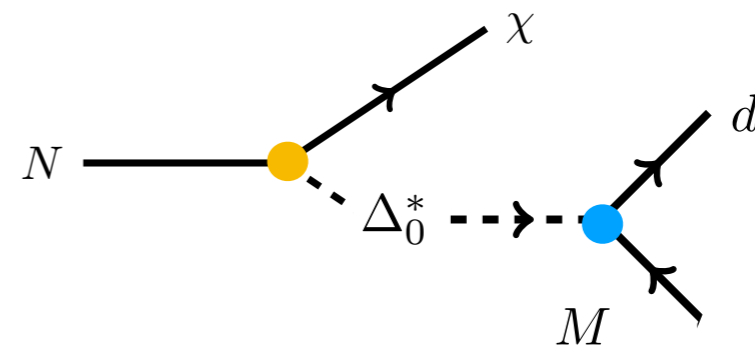

⇒ Minimal matter content (Embedding of the SM):

$$\bar{7} = \begin{pmatrix} d^c \\ \chi \\ \text{---} \\ \ell \end{pmatrix} \quad 21 = \left( \begin{array}{cc|c} u^c & M & q \\ -M^T & N & \Psi_2 \\ \text{---} & \text{---} & \text{---} \\ -q^T & -\Psi_2^T & e^c \end{array} \right)$$

$$7_H \sim \begin{pmatrix} S_1^* \\ \Delta_0 \\ \text{---} \\ H \end{pmatrix} \quad 48_H \quad 21_H$$



# Towards Grand Unification

$$SU(7) \supset SU(5) \otimes SU(2)_L \otimes U(1)_7 \supset \mathcal{G}_{SM} \otimes SU(2)_D$$

⇒ Simplest Yukawa interaction:

$$Y_e \bar{7} 21 7_H^*$$

Expand

$$\supset Y_e (d^c u^c S_1 + d^c M \Delta_0^* + \chi M S_1 + \chi N \Delta_0^*)$$

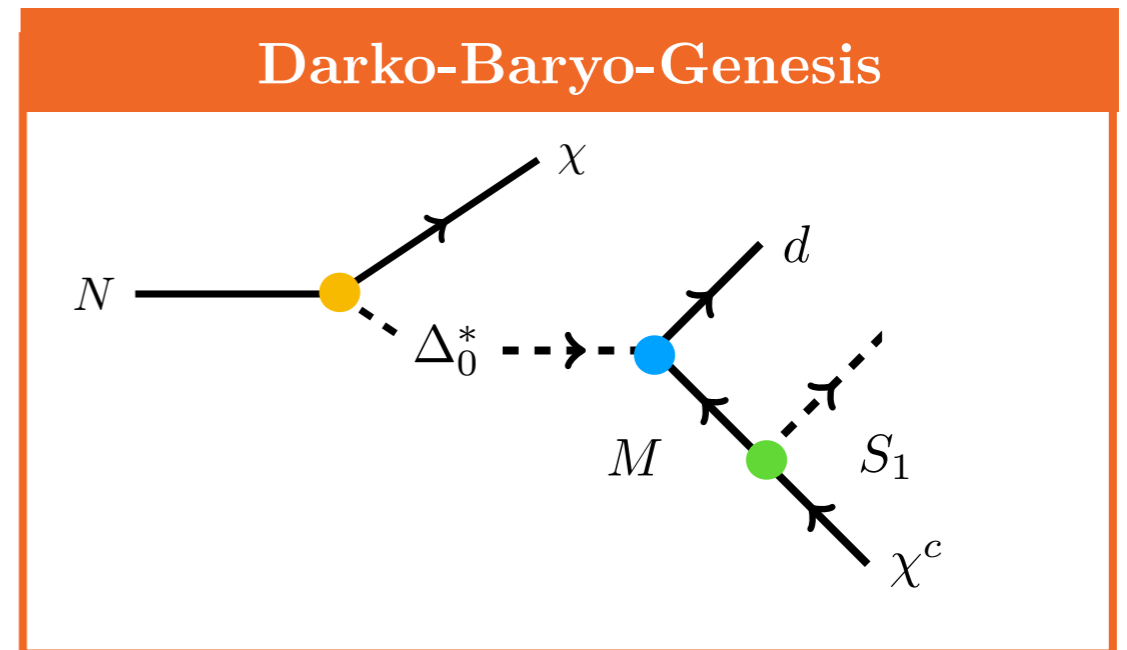

⇒ Minimal matter content (Embedding of the SM):

$$\bar{7} = \begin{pmatrix} d^c \\ \chi \\ \text{---} \\ \ell \end{pmatrix} \quad 21 = \left( \begin{array}{cc|c} u^c & M & q \\ -M^T & N & \Psi_2 \\ \text{---} & \text{---} & \text{---} \\ -q^T & -\Psi_2^T & e^c \end{array} \right)$$

$$7_H \sim \begin{pmatrix} S_1^* \\ \Delta_0 \\ \text{---} \\ H \end{pmatrix} \quad 48_H \quad 21_H$$



# Towards Grand Unification

$$SU(7) \supset SU(5) \otimes SU(2)_L \otimes U(1)_7 \supset \mathcal{G}_{SM} \otimes SU(2)_D$$

⇒ Simplest Yukawa interaction:

$$Y_e \bar{7} 21 7_H^*$$

Expand

$$\supset Y_e (d^c u^c S_1 + d^c M \Delta_0^* + \chi M S_1 + \chi N \Delta_0^*)$$

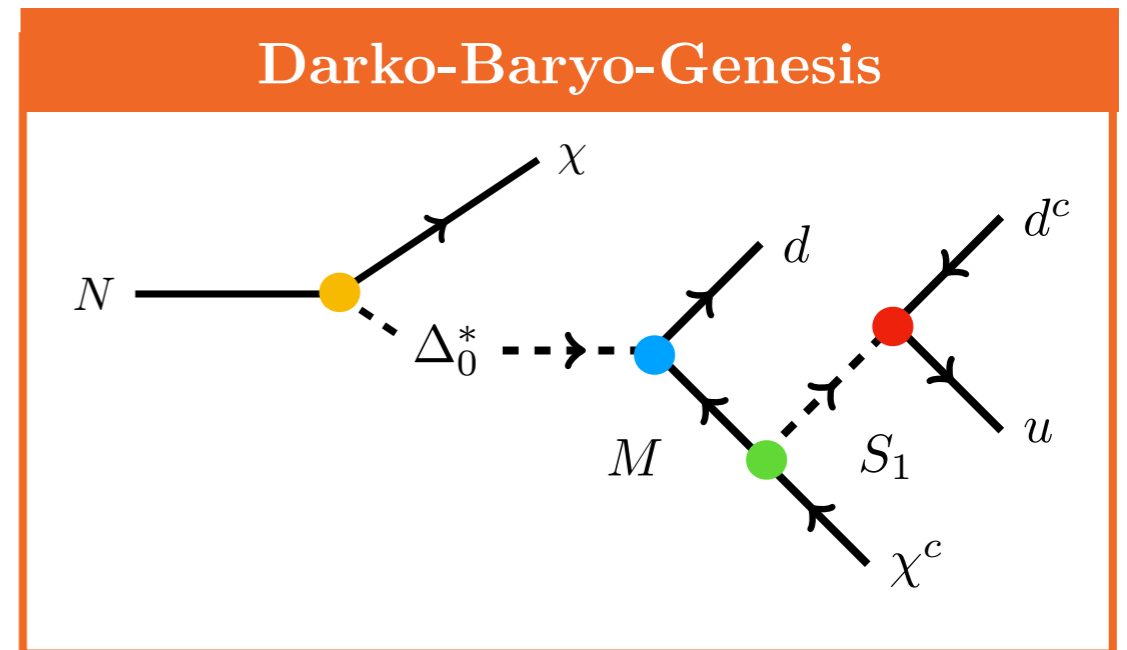

⇒ Minimal matter content (Embedding of the SM):

$$\bar{7} = \begin{pmatrix} d^c \\ \chi \\ \text{---} \\ \ell \end{pmatrix} \quad 21 = \left( \begin{array}{cc|c} u^c & M & q \\ -M^T & N & \Psi_2 \\ \text{---} & \text{---} & \text{---} \\ -q^T & -\Psi_2^T & e^c \end{array} \right)$$

$$7_H \sim \begin{pmatrix} S_1^* \\ \Delta_0 \\ \text{---} \\ H \end{pmatrix} \quad 48_H \quad 21_H$$



# Dark Unification in SU(7)

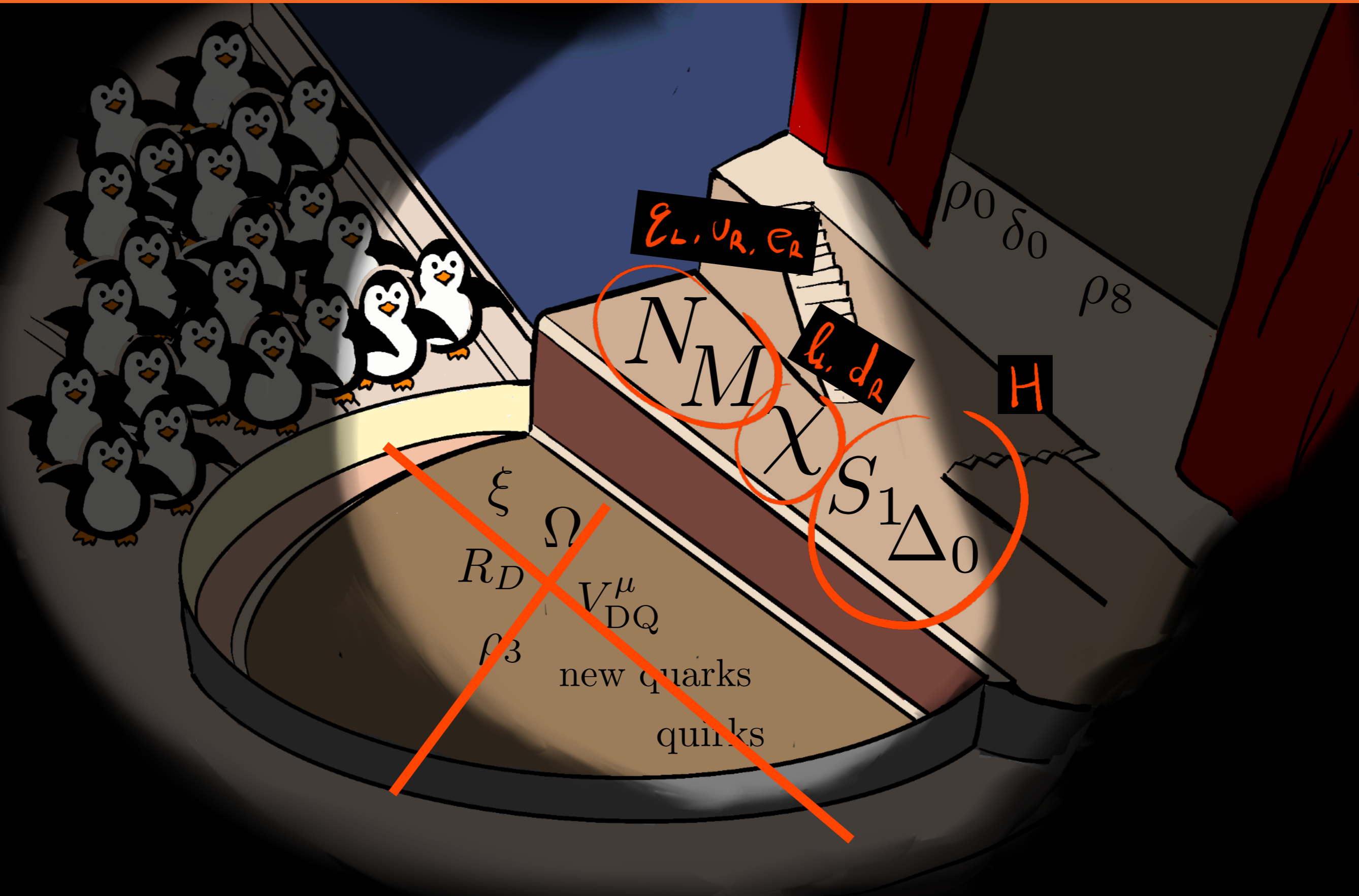

# Conclusions

- ⇒ Idea of Dark-Color Unification.
- ⇒ Simplest gauge group to achieve it: SU(5) hypercolor
  - ⇒ Anomaly-free within SM representations
  - ⇒ Naturally provides a mechanism for splitting quarks & quirks
  - ⇒ Can host an hadronic DM candidate (spin 1 baryon) and Darko-Baryo-genesis.
- ⇒ An (equal) asymmetry in the baryon and dark baryon sector ( $U(1)_{B-D} \Rightarrow Y_{\Delta B} = Y_{\Delta D}$ ) + nearby confinement scales ( $\Lambda_D \sim 6\Lambda_{\text{QCD}}$ ) justify same order relic densities ( $\Omega_D \sim 5\Omega_B$ ).
- ⇒ Colored fermions and scalars are predicted to be at the TeV scale.
- ⇒ DM self-interactions, Early Matter Domination, GW (amongst others) are expected.
- ⇒ The main drivers for darko-baryo-genesis and its required interactions appear (unavoidably) with the SM fields when unifying the strong and electroweak sectors in SU(7).

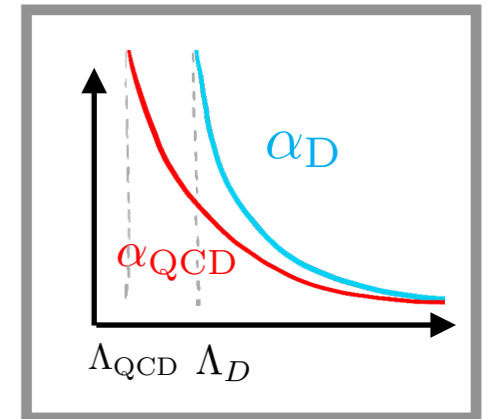

Thank you!



Back-up slides

# Charged Relics

[De Luca, Mitridate, Redi, Smirnov, Strumia, 2019]

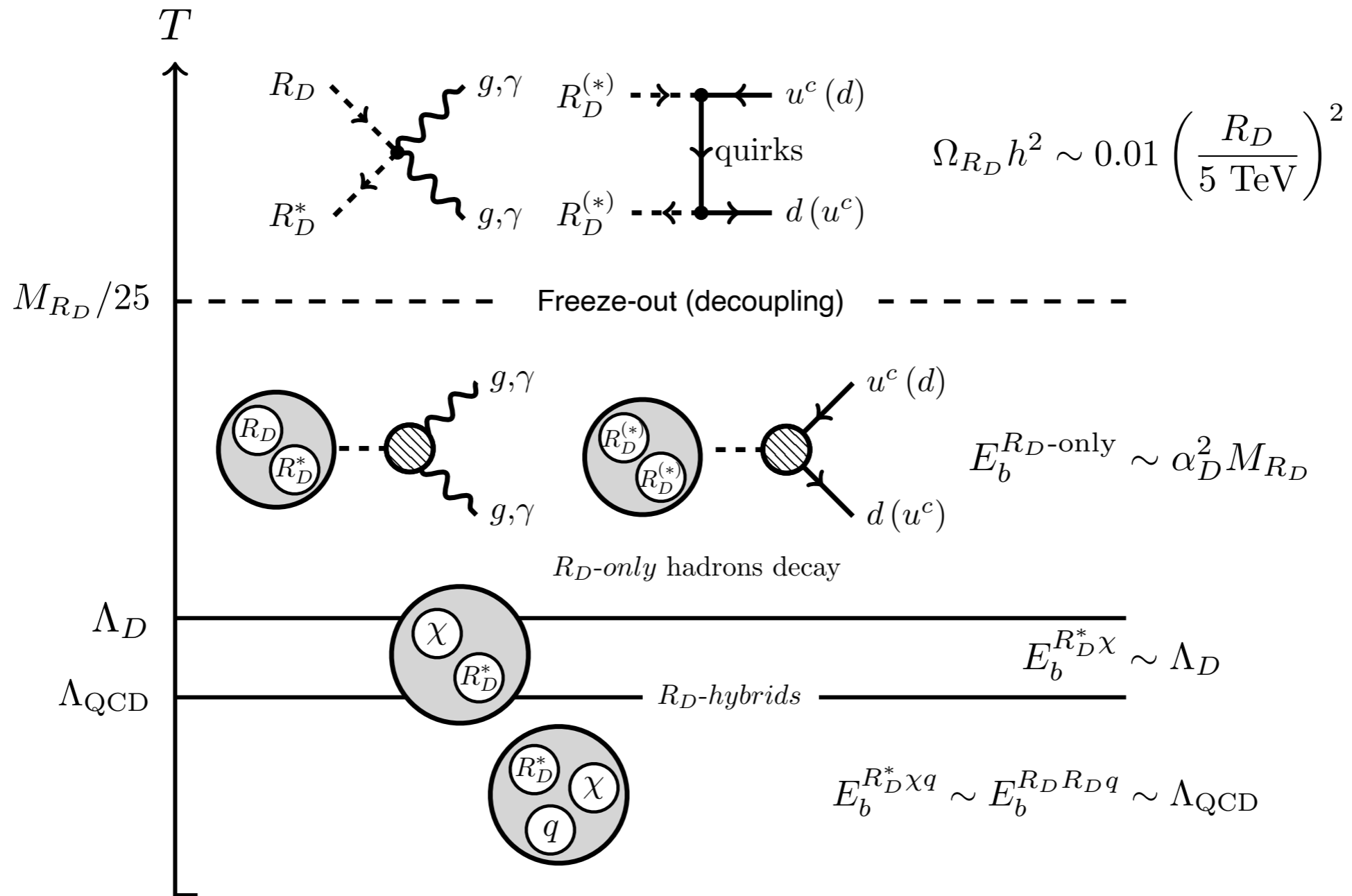



# Phenomenological signatures

⇒ Potential light fields

$S_1$   $M$   $R_D$   $\rho_8$

At colliders

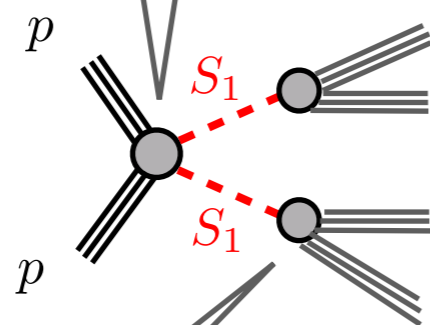
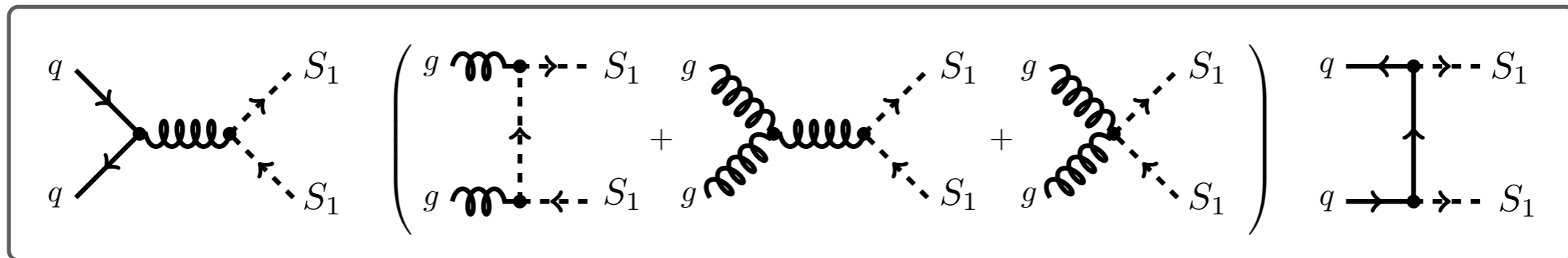

Scalar diquark constraints  
[CMS, 2019]

$$(M_{S_1} > 7.5 \text{ TeV})$$

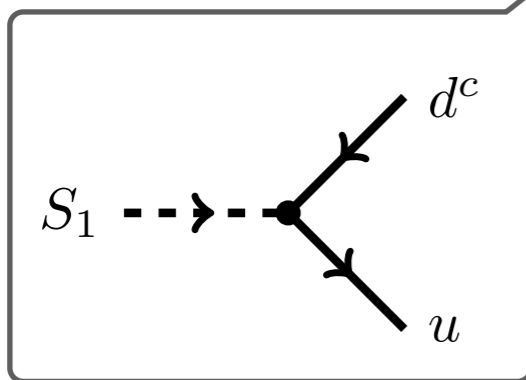

$S_1 \rightarrow 2 \text{ JETs}$

$$\tau_{S_1}^{-1} \simeq \frac{M_{S_1}}{4\pi} |Y_{\text{quirks}}|^2 \simeq 1.2 \times 10^{27} \text{ s}^{-1} \left( \frac{M_{S_1}}{10 \text{ TeV}} \right) \left( \frac{|Y_{\text{quirks}}|}{1} \right)^2$$



# Phenomenological signatures

⇒ Potential light fields

$S_1$   $M$   $R_D$   $\rho_8$

At colliders

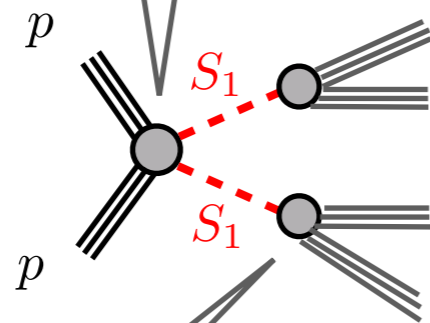
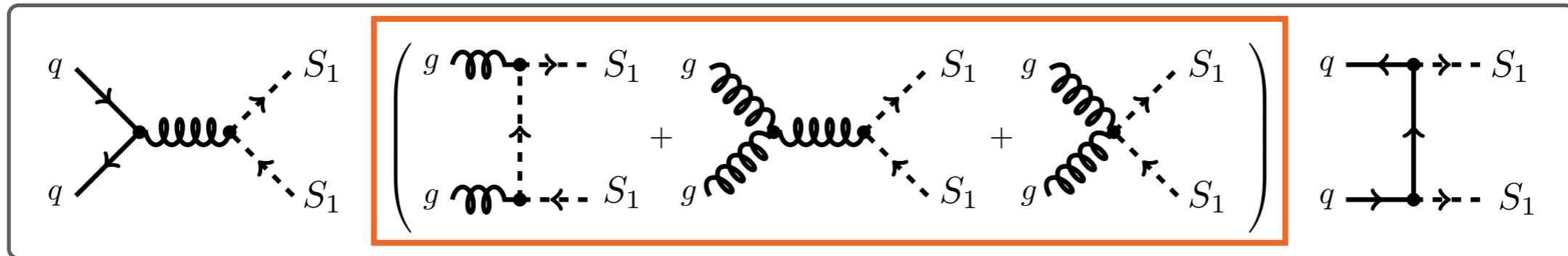

Scalar diquark constraints  
[CMS, 2019]

$(M_{S_1} > 7.5 \text{ TeV})$

$M_{S_1} \gtrsim 1 \text{ TeV}$

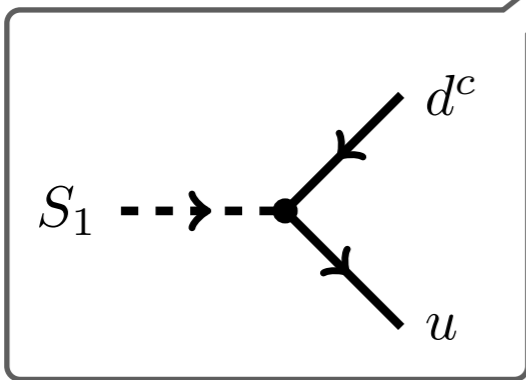

$S_1 \rightarrow 2 \text{ JETs}$

$$\tau_{S_1}^{-1} \simeq \frac{M_{S_1}}{4\pi} |Y_{\text{quirks}}|^2 \simeq 1.2 \times 10^{27} \text{ s}^{-1} \left( \frac{M_{S_1}}{10 \text{ TeV}} \right) \left( \frac{|Y_{\text{quirks}}|}{1} \right)^2$$



# Phenomenological signatures

⇒ Potential light fields

$S_1$   $M$   $R_D$   $\rho_8$

At colliders

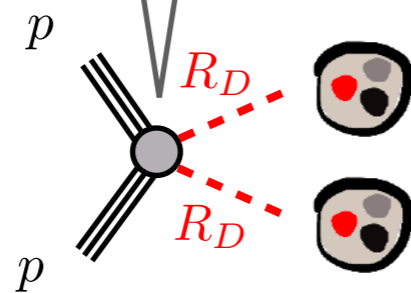
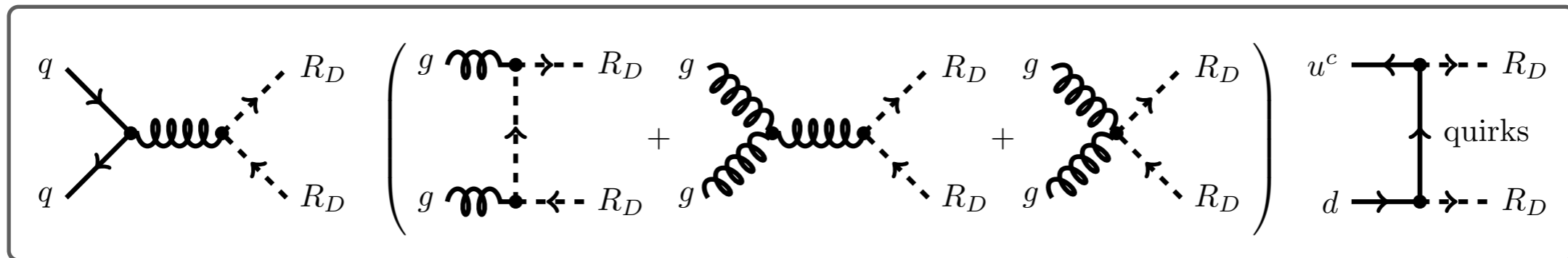

$$m_R \gtrsim 1 \text{ TeV} \quad [\text{CMS, 2016}]$$



# Phenomenological signatures

⇒ Potential light fields

$S_1$   $M$   $R_D$   $\rho_8$

At colliders

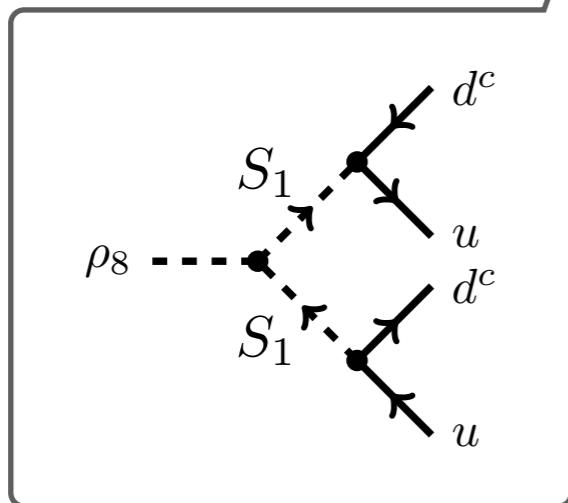
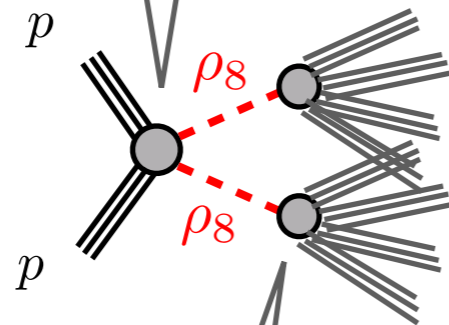
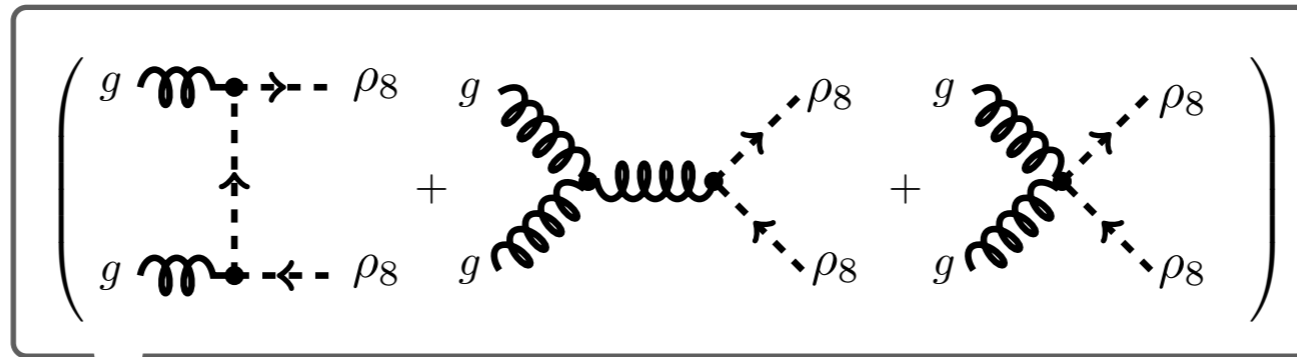

$\rho_8 \rightarrow 4$  JETs

$$\tau_{\rho_8}^{-1} \lesssim 5 \times 10^{13} \text{ s}^{-1} \left( \frac{|Y_{\text{quirks}}|}{1} \right)^4 \left( \frac{10 \text{ TeV}}{M_{S_1}} \right)^8 \left( \frac{M_{\rho_8}}{1 \text{ TeV}} \right)^9$$



# Phenomenological signatures

⇒ Potential light fields

$S_1$   $M$   $R_D$   $\rho_8$

At colliders

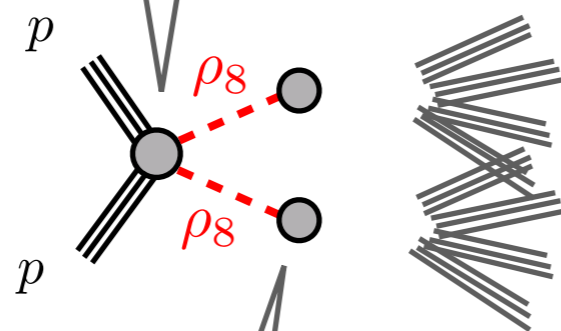
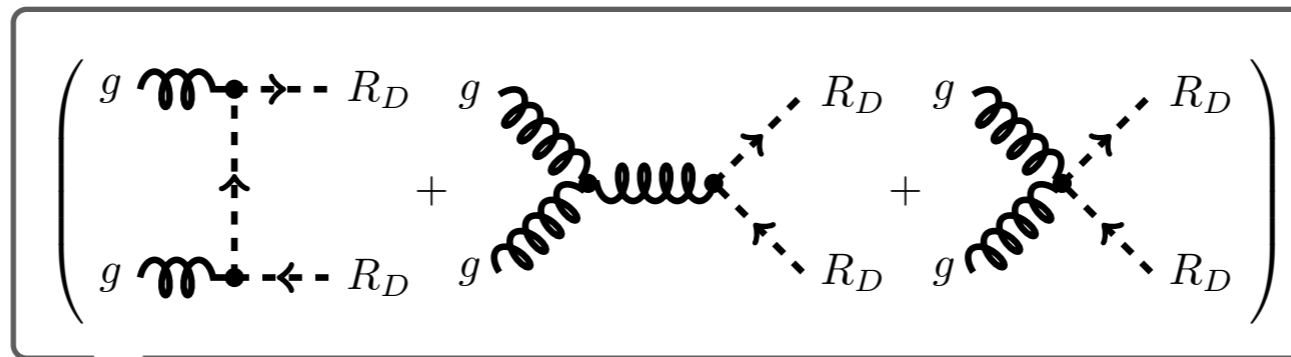

⇒ Potential displaced vertices of 4 jets

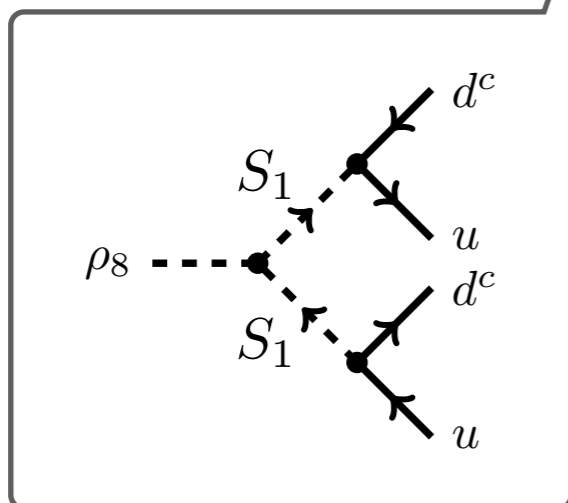

$\rho_8 \rightarrow 4$  JETs

$$\tau_{\rho_8}^{-1} \lesssim 5 \times 10^{13} \text{ s}^{-1} \left( \frac{|Y_{\text{quirks}}|}{1} \right)^4 \left( \frac{10 \text{ TeV}}{M_{S_1}} \right)^8 \left( \frac{M_{\rho_8}}{1 \text{ TeV}} \right)^9$$



# Pheno signatures

⇒ Potential light fields

$S_1$   $M$   $R_D$   $\rho_8$   $\Delta_0$

At colliders

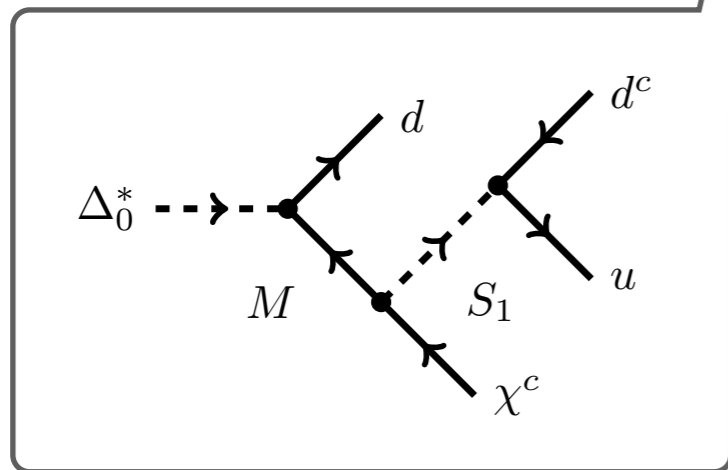
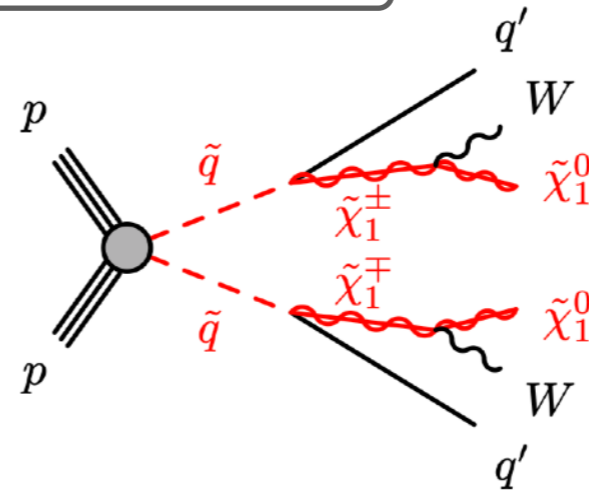
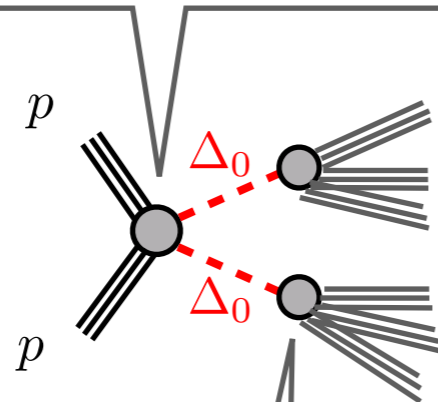
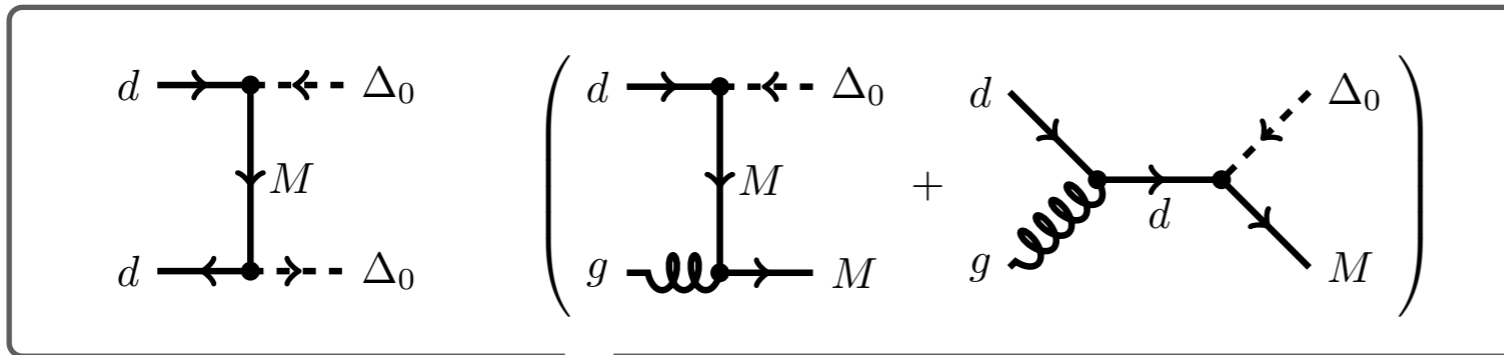

$\Delta_0 \rightarrow 3 \text{ JETs} + \text{MET}$

Stop searches  
[ATLAS, 2021]  
 $m_{\tilde{q}} > 1.3 \text{ TeV}$

# Pheno signatures

⇒ Potential light fields

$S_1$   $M$   $R_D$   $\rho_8$   $\Delta_0$

At colliders

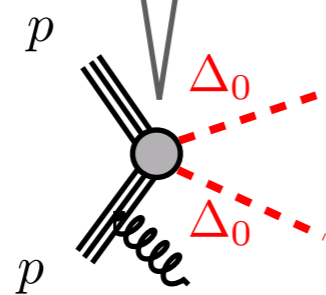
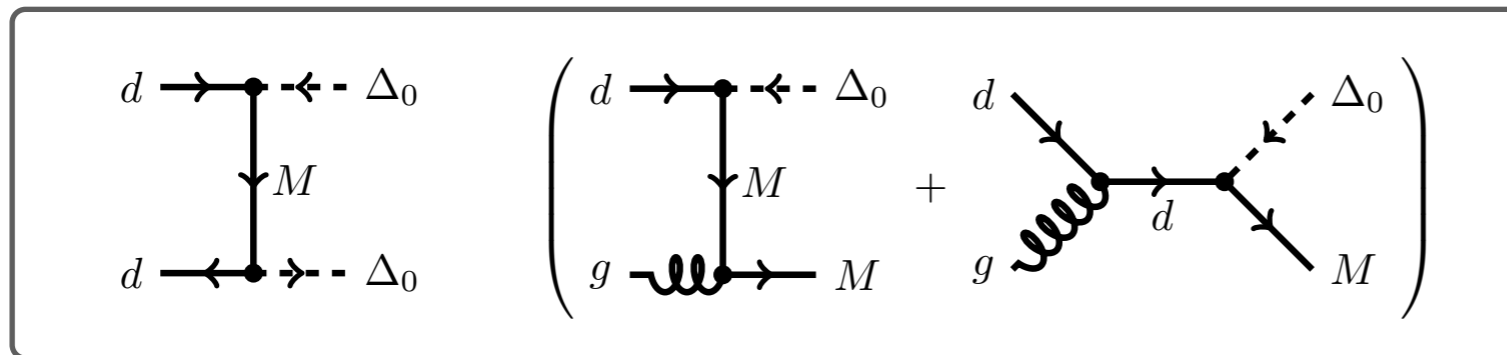

Monojet searches  
[ATLAS, 2021]

~~$\Delta_0 \rightarrow 3 \text{ JETs} + \text{MET}$~~

# Phenomenological signatures

## Flavor observables

### Meson mixing

[Pich, Mandal, 2019]

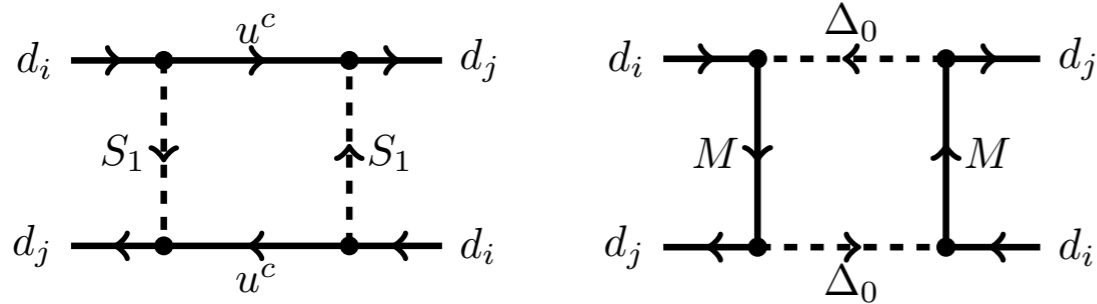

$$\sqrt{|\operatorname{Re}\{(Y_{\Delta_0}^1 (Y_{\Delta_0}^2)^*)^2\}}| \left(\frac{\text{TeV}}{M_{M/\Delta_0}}\right) \lesssim 0.01$$

$$\sqrt{|\operatorname{Im}\{(Y_{\Delta_0}^1 (Y_{\Delta_0}^2)^*)^2\}}| \left(\frac{\text{TeV}}{M_{M/\Delta_0}}\right) \lesssim 8 \times 10^{-4}$$

### Neutron EDM

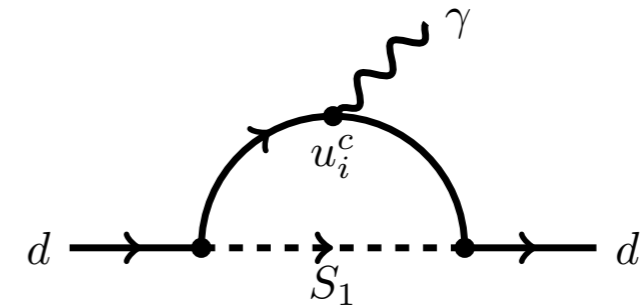

$$|d_d| \simeq \sum_j \frac{e}{6\pi^2} \frac{m_{q_j}}{M_{S_1}^2} \operatorname{Im}\{Y_\eta^{1j} (Y_\Psi^{1j})^*\} \ln\left(\frac{M_{S_1}}{m_{q_j}}\right)$$

$$\frac{\operatorname{Im}\{Y_{\text{quirks}}\}}{M_{S_1}/\text{TeV}} \lesssim 4 \times 10^{-4}$$





# Is the DM stable enough?

$$\frac{1}{\Lambda^{3.5}} \chi \chi q q q$$

$$\mathcal{L} \supset Y_{\Delta_0} (d^c Q_N^c \Omega^* + \eta_d M \Omega^* + d^c M \Delta_0^* + \eta_d \xi \Delta_0^*) \\ + Y_\chi (\chi \Delta_0^* + q_N \Omega^*) N + Y_{\bar{\chi}} (q_N^c \Omega + \chi^c \Delta_0) N + \text{h.c.}$$

$$\Rightarrow U(1)_{B-D}$$



# Is the DM stable enough?

$$\frac{1}{\Lambda^5} \chi \chi q q q N$$

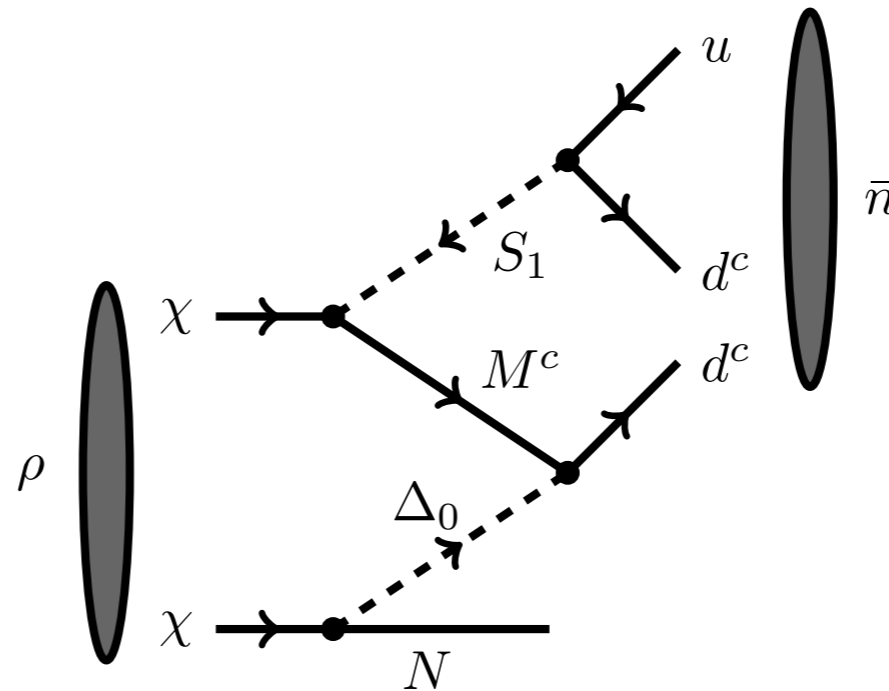

$$\mathcal{L} \supset Y_{\Delta_0} (d^c Q_N^c \Omega^* + \eta_d M \Omega^* + d^c M \Delta_0^* + \eta_d \xi \Delta_0^*)$$

$$+ Y_\chi (\chi \Delta_0^* + q_N \Omega^*) N + Y_{\bar{\chi}} (q_N^c \Omega + \chi^c \Delta_0) N + \text{h.c.}$$

$$\Rightarrow U(1)_{B-D}$$



# Is the DM stable enough?

$$\frac{1}{\Lambda^6} \chi \chi q q q \nu h$$

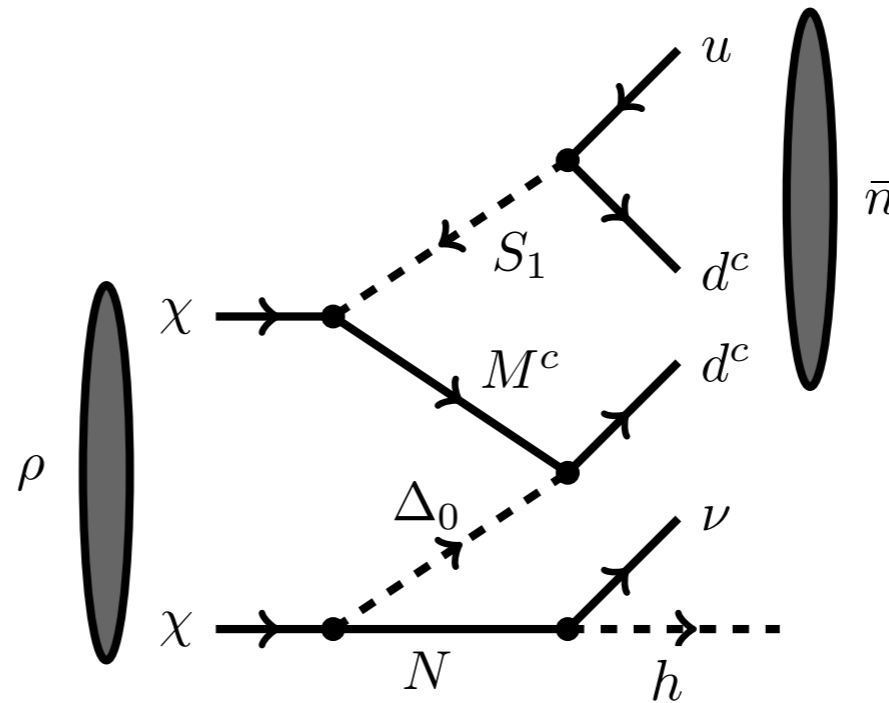

$$\mathcal{L} \supset Y_{\Delta_0} (d^c Q_N^c \Omega^* + \eta_d M \Omega^* + d^c M \Delta_0^* + \eta_d \xi \Delta_0^*)$$

$$+ Y_\chi (\chi \Delta_0^* + q_N \Omega^*) N + Y_{\bar{\chi}} (q_N^c \Omega + \chi^c \Delta_0) N + \text{h.c.}$$

$$\Rightarrow U(1)_{B-D}$$



# Is the DM stable enough?

$$\frac{1}{\Lambda^8} \chi \chi q q q \nu \bar{f} f$$

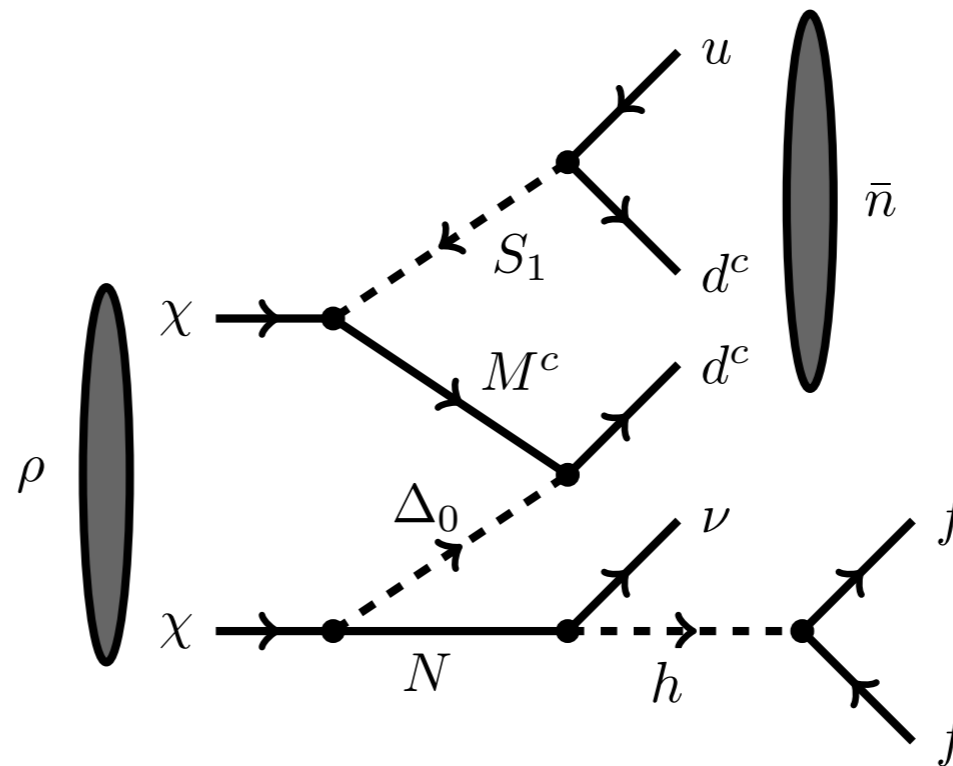

$$\mathcal{L} \supset Y_{\Delta_0} (d^c Q_N^c \Omega^* + \eta_d M \Omega^* + d^c M \Delta_0^* + \eta_d \xi \Delta_0^*) \\ + Y_\chi (\chi \Delta_0^* + q_N \Omega^*) N + Y_{\bar{\chi}} (q_N^c \Omega + \chi^c \Delta_0) N + \text{h.c.}$$

$$\Rightarrow U(1)_{B-D}$$



# Is the DM stable enough?

$$\mathcal{O}_{B-D} \sim \frac{Y_f Y_{\text{quirks}} Y_\nu Y_{\Delta_0} Y_{\text{DN}} Y_{\text{NewQ}}}{m_H^2 M_M M_{S_1}^2 M_N M_{\Delta_0}^2} (\bar{d}^c \chi) (\bar{\nu} \chi) (\bar{d}^c u) (\bar{f} f)$$

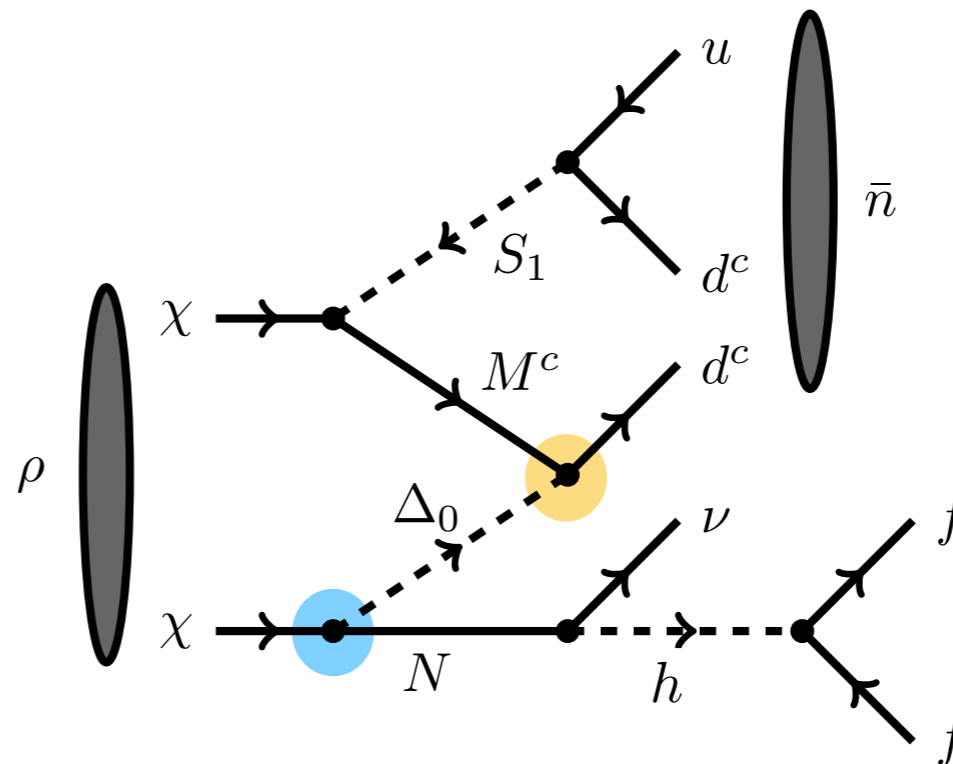

$$\Rightarrow \mathcal{L} \supset Y_{\Delta_0} (d^c Q_N^c \Omega^* + \eta_d M \Omega^* + d^c M \Delta_0^* + \eta_d \xi \Delta_0^*) \\ + Y_\chi (\chi \Delta_0^* + q_N \Omega^*) N + Y_{\bar{\chi}} (q_N^c \Omega + \chi^c \Delta_0) N + \text{h.c.}$$

$$\Rightarrow U(1)_{B-D}$$



# Dark Spectrum

$$\Rightarrow \rho = \begin{pmatrix} \rho^+ \\ \rho^0 \\ \rho^- \end{pmatrix} \sim \begin{pmatrix} \chi_D \chi_D \\ \chi_D^c \chi_D \\ \chi_D^c \chi_D^c \end{pmatrix}$$

$$\rho_\mu^a = \bar{X} \gamma_\mu \tau^a X, \quad \text{where} \quad X = \begin{pmatrix} \chi_L \\ -i\sigma_2 C \bar{\chi}_R^T \end{pmatrix}$$

$$\begin{aligned} \rho_\mu^0 &= \bar{X} \gamma_\mu \tau^3 X &&= \overline{\chi_D} \gamma_\mu \chi_D, \\ \sqrt{2} \rho_\mu^+ &= \bar{X} \gamma_\mu (\tau^1 - i\tau^2) X &&= \overline{\chi_D^c} \gamma_\mu i\sigma_2 \chi_D, \\ \sqrt{2} \rho_\mu^- &= \bar{X} \gamma_\mu (\tau^1 + i\tau^2) X &&= \overline{\chi_D} \gamma_\mu i\sigma_2^T \chi_D^c. \end{aligned}$$

# Symmetries

	$\mathbf{5}_q$		$\bar{\mathbf{5}}_u$		$\bar{\mathbf{5}}_d$		$\mathbf{5}_\chi$		10		$10_H$			$24^\mu$	
Sym	$\Psi$	$q$	$u^c$	$\eta_u$	$d^c$	$\eta_d$	$\chi$	$q_N$	$Q_N^c$	$M$	$\xi$	$S_1$	$R_D$	$\delta_0$	$V_{DQ}^\mu$
$U(1)_B$	-	1/3	-1/3	-	-1/3	-	-	1/3	-1/3	-2/3	-1	2/3	1/3	-	1/3
$U(1)_D$	-	-	-	-	-	-	1/2	1/2	-1/2	-1/2	-1/2	-	-	-	-
$U(1)_Q$	1/2	-	-	-1/2	-	-1/2	-	-1/2	-1/2	-	1/2	-	1/2	1	-1/2

➔ Interactions at the  $SU(5) \otimes SU(2)_L \otimes U(1)_X$  level

$$\begin{aligned} \mathcal{L} \supset & Y_\Psi \mathbf{5}_\Psi \mathbf{5}_\Psi \mathbf{10}_H^* + Y_\eta \bar{\mathbf{5}}_d \bar{\mathbf{5}}_u \mathbf{10}_H \\ & + Y_q \mathbf{5}_\chi \mathbf{10} \mathbf{10}_H \epsilon_5 + Y_{\bar{q}} \bar{\mathbf{5}}_\chi \bar{\mathbf{10}} \bar{\mathbf{10}} \epsilon_5 + \text{h.c.} \end{aligned}$$

➔ Interactions at the  $SM \otimes SU(2)_D$  level

$$\begin{aligned} -\mathcal{L} \supset & Y_\Psi (\Psi \Psi \delta_0^* + Q Q S_1^* + \psi Q R_D^*) + Y_\eta (\eta_u \eta_d \delta_0 + u^c d^c S_1 + \eta_u d^c R_D + \eta_d u^c R_D) \\ & + Y_q (q_N Q_N^c \delta_0 + q_N M R_D + q_N \xi S_1 + \chi Q_N^c R_D + \chi M S_1) \\ & + Y_{\bar{q}} (q_N^c Q_N \delta_0^* + q_N^c M^c R_D^* + q_N^c \xi^c S_1^* + \chi^c Q_N R_D^* + \chi^c M^c S_1^*) + \text{h.c.} \end{aligned}$$

# Other sources of B violation

⇒ Sphalerons

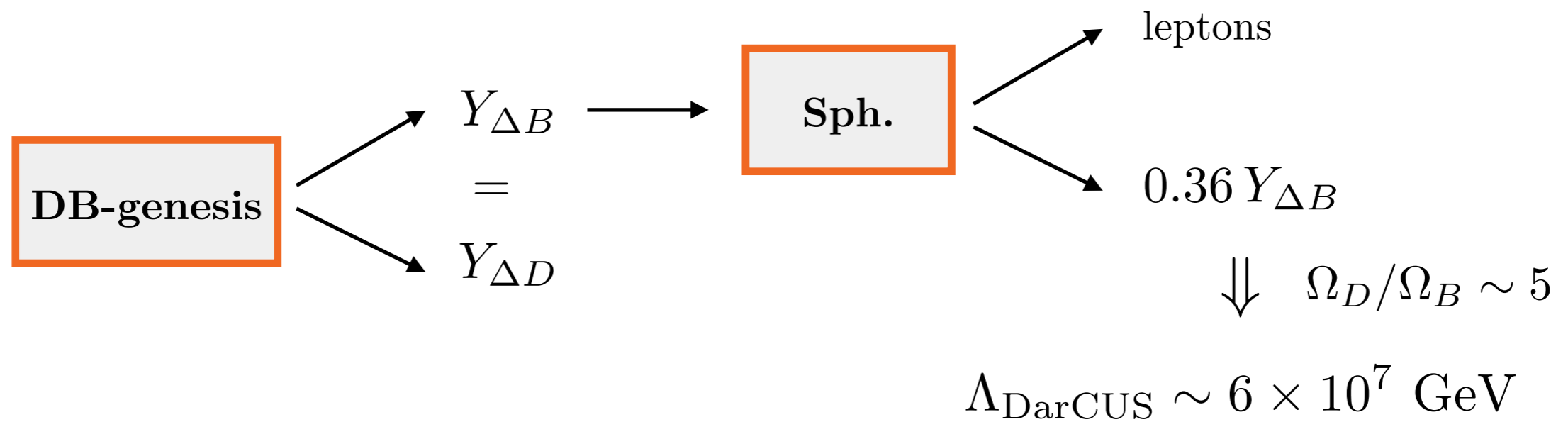

⇒  $V \supset \lambda 10_H^* 5_H 24_H 5_H + \text{h.c.}$



# Annihilation symmetric abundance

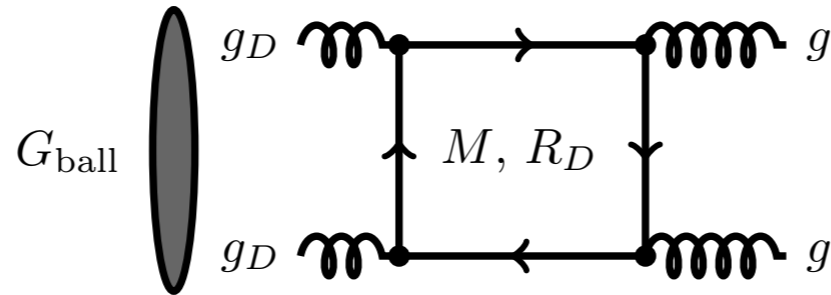
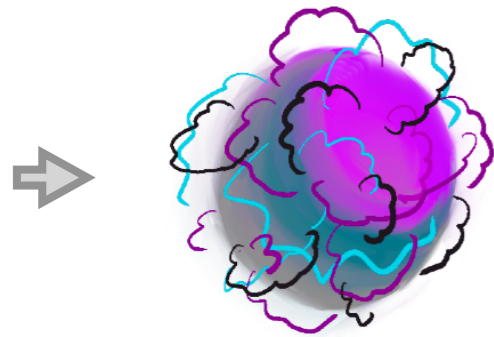

$$m_{G_{\text{ball}}} \sim n \Lambda_D$$

$$\tau_{G_{\text{ball}}} \simeq 0.5 \text{ s} \left( \frac{0.8}{\alpha_{\text{QCD}}} \right)^2 \left( \frac{0.8}{\alpha_D} \right)^2 \left( \frac{M_M}{1 \text{ TeV}} \right)^8 \left( \frac{2 \text{ GeV}}{\Lambda_D} \right)^9$$

Light connectors  $M$  or  $R_D$

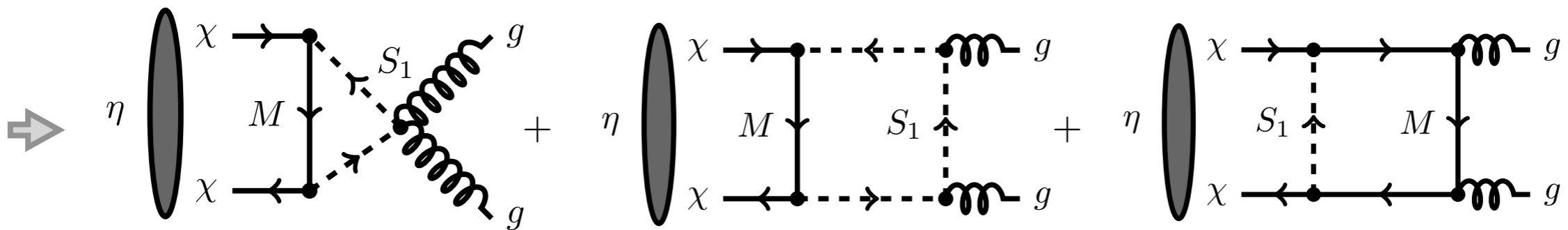

$$\tau_{\eta}^{-1} \sim 8 \text{ s}^{-1} \left( \frac{\alpha_{\text{QCD}}}{0.8} \right)^2 \left( \frac{|Y_{\text{NewQ}}|}{1} \right)^4 \left( \frac{10 \text{ TeV}}{M_{S_1/M}} \right)^6 \left( \frac{m_{\eta}}{4 \text{ GeV}} \right)^7$$

Light connectors  $M$  or  $S_1$

Early Matter Domination!



# Dark Spectrum

⇒  $N_f$  (light) flavors +  $SU(2)_D$

$$2 \equiv \square \equiv \bar{2} \quad \text{enlarged symmetry!}$$

$$U(N_f)_L \otimes U(N_f)_R \xrightarrow{\text{enlarged}} U(2N_f) = U(1)_A \otimes SU(2N_f)$$

$$\#_{\text{broken gen}} = (2N_f + 1)(N_f - 1)$$

$$\begin{array}{c} | \\ \chi_{\text{SB}} \quad \langle \bar{\chi} \chi \rangle \\ \downarrow \end{array}$$

$$Sp(2N_f)$$

$$N_f = 1$$



No Goldstones! (No dark pions)

$$Q_D \left( \begin{array}{c} \bullet \\ \chi \end{array} \right) = \frac{1}{2}$$

Dark Baryon Number (D)

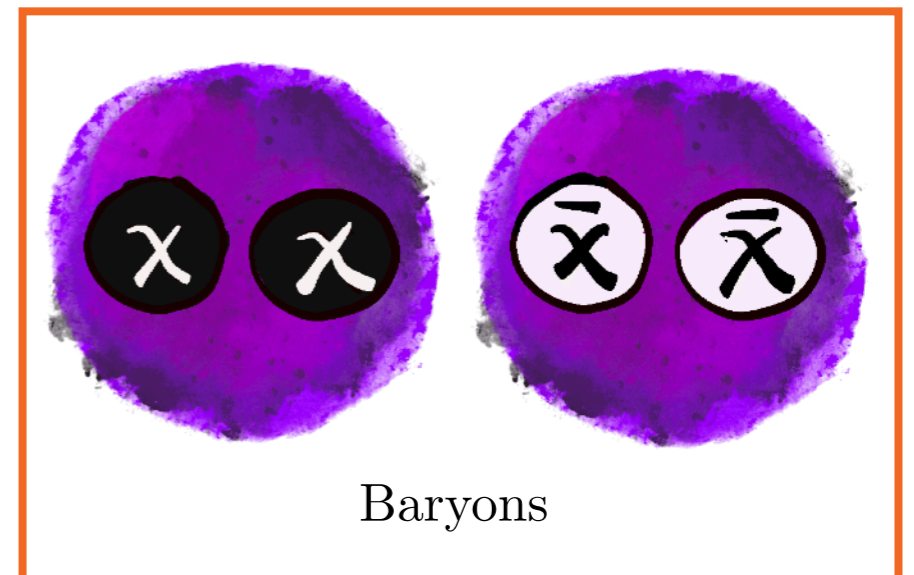

# Dark Spectrum

[Francis, Hudspith, Lewis, Tulin, 2008]

⇒ One (light) flavor +  $SU(2)_D$

$$\chi_D = \chi_L + (\chi_L^c)^c = \chi_L + \chi_R$$

$$\mathcal{L}_{SU(2)_D}^{\text{eff}} = -\frac{1}{2} \text{Tr}\{G_{D\mu\nu}G_D^{\mu\nu}\} + \bar{\chi}_D(iD_\mu\gamma^\mu - m_\chi)\chi_D + \dots$$

$$X = \begin{pmatrix} \chi_L \\ -i\sigma_2 C \bar{\chi}_R^T \end{pmatrix} \Rightarrow \mathcal{L}_{SU(2)_D}^{\text{eff}} = \bar{X}iD_\mu\gamma^\mu X - \frac{m_\chi}{2} (X^T i\sigma_2 C E X + \bar{X}i\sigma_2 C E \bar{X}^T) + \dots$$

Dark (matter) baryon

$$\text{vector } (1^-) \quad \rho = \begin{pmatrix} \rho^+ \\ \rho^0 \\ \rho^- \end{pmatrix} \sim \begin{pmatrix} \chi\chi \\ \frac{1}{\sqrt{2}}(\chi\bar{\chi} + \bar{\chi}\chi) \\ \bar{\chi}\bar{\chi} \end{pmatrix}$$

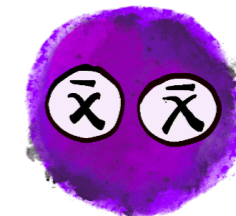
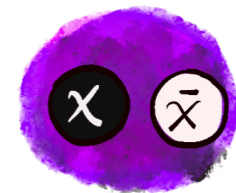
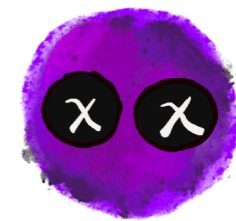

# Towards Grand Unification

$$SU(7) \supset SU(5) \otimes SU(2)_L \otimes U(1)_7 \supset \mathcal{G}_{SM} \otimes SU(2)_D$$

$$\mathbf{4} \quad SU(2)_L \otimes U(1)_Y \rightarrow U(1)_{em} \quad \Rightarrow \quad \mathbf{7}_H \sim \begin{pmatrix} S_1^* \\ \Delta_0 \\ \hline H \end{pmatrix}$$

⇒ Breaking patterns:

$$\begin{aligned} \mathbf{1} \quad SU(7) &\xrightarrow{\langle 48_H \rangle} SU(5) \otimes SU(2)_L \otimes U(1)_7 & \mathbf{3} \quad U(1)_7 \otimes U(1)_5 &\xrightarrow{\langle 21_H \rangle} U(1)_Y \\ \mathbf{2} \quad SU(5) \otimes SU(2)_L \otimes U(1)_7 &\xrightarrow{\langle 24_H \rangle} SU(3)_C \otimes SU(2)_L \otimes U(1)_7 \otimes U(1)_5 \otimes SU(2)_D \end{aligned}$$

⇒ Minimal matter content (Embedding of the SM):

$$\bar{\mathbf{7}} = \begin{pmatrix} d^c \\ \chi \\ \hline \ell \end{pmatrix} \quad \text{and} \quad \mathbf{21} = \left( \begin{array}{cc|c} u^c & M & q \\ -M^T & N & \Psi_2 \\ \hline -q^T & -\Psi_2^T & e^c \end{array} \right)$$



# Towards an anomaly-free SU(7)

➔ Anomaly-free theory

$$\mathbf{1} \quad \bar{7} + 21 + \bar{35}$$

$$\mathbf{2} \quad 5 \times \bar{7} + 21 + 35$$

$$\bar{35} = (10, 1, -6) \oplus (\bar{10}, 2, 1) \oplus (\bar{5}, 1, 8)$$

$$\begin{array}{lll} (\bar{3}, 1, \frac{1}{3}, 1) & (\bar{3}, 2, \frac{1}{6}, 1) & (\bar{3}, 1, \frac{2}{3}, 1) \\ (3, 1, -\frac{2}{3}, 2) & (\bar{3}, 2, \frac{1}{6}, 2) & (1, 1, -1, 2) \\ (1, 1, 1, 1) & (1, 2, -\frac{1}{2}, 1) & \end{array}$$