

Mass hierarchies in string theory and experimental predictions

I. Antoniadis

CERN

PLANCK 2011 - From the Planck to the Electroweak Scale

IST - Lisbon, 30 May - 3 June 2011

- 1 Motivations and mass hierarchy
- 2 Strings, branes and extra dimensions (flat and warped)
- 3 Gravity scale and number of species
- 4 Low string coupling and linear dilaton background
- 5 Main accelerator signatures

BSM physics: driven by mass hierarchy problem

Higgs mass: very sensitive to high energy physics $m_H \sim \text{UV cutoff } \Lambda$

why gravity is so weak compared to the other interactions? $\Lambda = M_P$

Possible answer (alternative to supersymmetry): Low UV cutoff $\Lambda \sim \text{TeV}$

- low scale gravity \Rightarrow large extra dimensions, warped dimensions
- low string scale \Rightarrow low scale gravity, ultra weak string coupling

Experimentally testable framework:

- spectacular model independent predictions
- radical change of high energy physics at the TeV scale

Framework of type I string theory \Rightarrow D-brane world

I.A.-Arkani-Hamed-Dimopoulos-Dvali '98

- gravity: closed strings propagating in 10 dims
- gauge interactions: open strings with their ends attached on D-branes

Dimensions of finite size: n transverse $6 - n$ parallel

calculability $\Rightarrow R_{\parallel} \simeq l_{\text{string}}$; R_{\perp} arbitrary

$$M_P^2 \simeq \frac{1}{g_s^2} M_S^{2+n} R_{\perp}^n \quad g_s = \alpha : \text{weak string coupling}$$

Planck mass in $4 + n$ dims: M_*^{2+n}

$$M_S \sim 1 \text{ TeV} \Rightarrow R_{\perp}^n = 10^{32} l_S^n \quad \text{small } M_S/M_P : \text{extra-large } R_{\perp}$$

$$R_{\perp} \sim .1 - 10^{-13} \text{ mm for } n = 2 - 6 \quad [5]$$

distances $< R_{\perp}$: gravity $(4+n)$ -dim \rightarrow strong at 10^{-16} cm [6]

Braneworld

2 types of compact extra dimensions:

- parallel (d_{\parallel}): $\lesssim 10^{-16}$ cm (TeV)
- transverse (\perp): $\lesssim 0.1$ mm (meV)

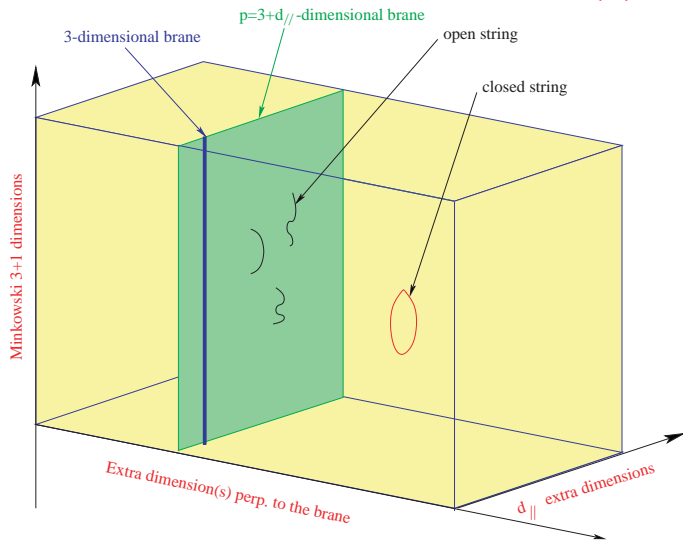

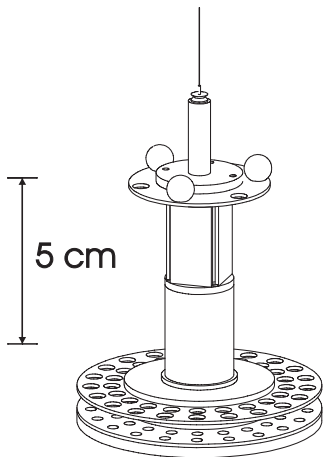

$R_{\perp} \lesssim 45 \mu\text{m}$ at 95% CL

- dark-energy length scale $\approx 85 \mu\text{m}$ [3]

Gravitational radiation in the bulk \Rightarrow missing energy

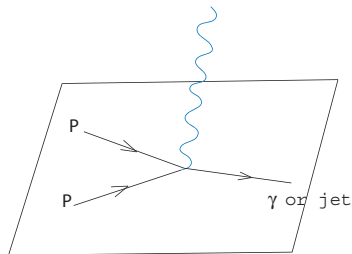

Angular distribution \Rightarrow spin of the graviton

Collider bounds on R_{\perp} in mm			
	$n = 2$	$n = 4$	$n = 6$
LEP 2	4.8×10^{-1}	1.9×10^{-8}	6.8×10^{-11}
Tevatron	5.5×10^{-1}	1.4×10^{-8}	4.1×10^{-11}
LHC	4.5×10^{-3}	5.6×10^{-10}	2.7×10^{-12}

Randal Sundrum models

spacetime = slice of AdS_5 : $ds^2 = e^{-2k|y|} \eta_{\mu\nu} dx^\mu dx^\nu + dy^2$ $k^2 \sim \Lambda/M_5^3$

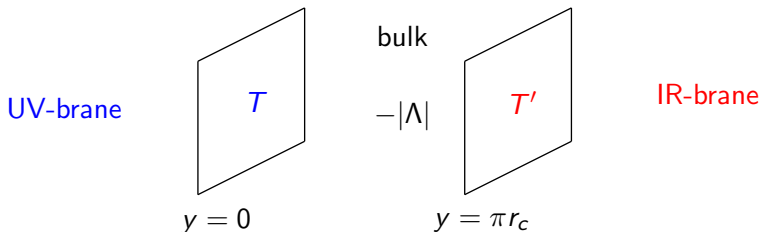

- exponential hierarchy: $M_W = M_P e^{-2kr_c}$ $M_P^2 \sim M_5^3/k$ $M_5 \sim M_{GUT}$

- 4d gravity localized on the UV-brane, but KK gravitons on the IR

$$m_n = c_n k e^{-2kr_c} \sim \text{TeV} \quad c_n \simeq (n + 1/4) \text{ for large } n$$

\Rightarrow spin-2 TeV resonances in di-lepton or di-jet channels [14] [15]

Other accelerator signatures

- Large TeV dimensions seen by SM gauge interactions

⇒ KK resonances of SM gauge bosons

I.A. '90

$$M_n^2 = M_0^2 + \frac{n^2}{R^2} \quad ; \quad n = \pm 1, \pm 2, \dots$$

- string physics and possible strong gravity effects

Massive string vibrations ⇒ e.g. resonances in dijet distribution

$$M_j^2 = M_0^2 + M_s^2 j \quad ; \quad \text{maximal spin} : j + 1$$

higher spin excitations of quarks and gluons with strong interactions

Anchordoqui-Goldberg-Lüst-Nawata-Taylor-Stieberger '08

production of micro-black holes?

Giddings-Thomas, Dimopoulos-Landsberg '01

Black hole production

String-size black hole energy threshold : $M_{\text{BH}} \simeq M_s/g_s^2$

Horowitz-Polchinski '96, Meade-Randall '07

- string size black hole: $r_H \sim l_s = M_s^{-1}$
- black hole mass: $M_{\text{BH}} \sim r_H^{d-3}/G_N$ $G_N \sim l_s^{d-2} g_s^2$

weakly coupled theory \Rightarrow strong gravity effects occur much above M_s , M_*

$g_s \sim 0.1$ (gauge coupling) $\Rightarrow M_{\text{BH}} \sim 100M_s$

Comparison with Regge excitations : $M_n = M_s \sqrt{n} \Rightarrow$

production of $n \sim 1/g_s^4 \sim 10^4$ string states before reach M_{BH} [3]

More general framework: large number of species

N particle species \Rightarrow lower quantum gravity scale : $M_*^2 = M_p^2/N$

Dvali '07, Dvali, Redi, Brustein, Veneziano, Gomez, Lüst '07-'10

derivation from: black hole evaporation or quantum information storage

Pixel of size L containing N species storing information:

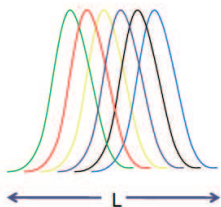

localization energy $E \gtrsim N/L \rightarrow$

Schwarzschild radius $R_s = N/(LM_p^2)$

no collapse to a black hole : $L \gtrsim R_s \Rightarrow L \gtrsim \sqrt{N}/M_p = 1/M_*$

$M_* \simeq 1 \text{ TeV} \Rightarrow N \sim 10^{32}$ particle species !

2 ways to realize $N = 10^{32}$ lowering the string scale

- ① Large volume compactifications SM on D-branes [3]

$N = R_{\perp}^n l_s^n$: number of KK modes up to energies of order $M_* \simeq M_s$

- ② $N \sim$ effective number of string modes contributing to the BH bound

Dvali-Lüst '09, Dvali-Gomez '10

$N_s = \frac{1}{g_s^2}$ with $g_s \simeq 10^{-16}$ SM on NS5-branes

I.A.-Pioline '99, I.A.-Dimopoulos-Giveon '01

in this case gravity does NOT become strong at M_s

Both ways are compatible with the general string relation:

$$M_P^2 = \frac{1}{g_s^2} V_6 M_s^8 \quad V_6 : \text{internal } 6d \text{ compactification volume}$$

What is LST ? **Decouple gravity from NS5-branes**

Analogy from D3-branes : decouple gravity $\Rightarrow M_s \rightarrow \infty$, g_s fixed
 \rightarrow (conformal) Field Theory (CFT)

simplest case: 4d $\mathcal{N} = 4$ super Yang Mills **$SU(N)$**

parameters: number of branes N , gauge coupling g_{YM}

NS-5 branes: M_s finite, $g_s \rightarrow 0 \rightarrow$ (little) String Theory without gravity

simplest case: 6d LST (**chiral IIA or non-chiral IIB**)

massless sector: 6d $SU(N)$ of vectors (**IIA**) or tensors (**IIB**)

at a non-trivial fixed point

parameters: number of branes N , string scale M_s

How to study LST ? Using gauge/gravity duality

Gravity background : near horizon geometry (holography) Maldacena '98

Analogy from D3-branes : $AdS_5 \times S^5$

parameters: AdS radius $r_{AdS} M_s$, $g_s \leftrightarrow N, g_{YM}$

supergravity validity: $r_{AdS} M_s \gg 1$, $g_s \ll 1 \Rightarrow$ large N , $g_{YM}^2 N$

\rightarrow model independent part : AdS_5

NS-5 branes : $(\mathcal{M}_6 \otimes R_+) \times SU(2) \equiv S^3$

\uparrow
linear dilaton background in 7d flat string-frame metric $\Phi = -\alpha|y|$

Aharony-Berkooz-Kutasov-Seiberg '98

parameters: M_s , α (or S^3 radius) $\leftrightarrow N$

sugra validity: small $\alpha \Rightarrow$ large N

compactify to $d = 4$ ($\mathcal{M}_6 \rightarrow \mathcal{M}_4$) $\Rightarrow g_{YM} \sim$ 2d volume

\rightarrow model independent part : linear dilaton

Put gravity back **but weakly coupled**

“cut” the space of the extra dimension \Rightarrow gravity on the brane

Analogy from D-branes \rightarrow 2 possibilities:

- flat space \Rightarrow large extra dimensions AADD '98
- curved space from gravity back reaction \Rightarrow slice of AdS_5

RS, H. Verlinde '99

NS-5 branes : **linear dilaton** on an interval $y \in [0, r_c]$

$$S_{bulk} = \int d^4x dy \sqrt{-g} e^{-\Phi} (M_5^3 R + M_5^3 (\nabla\Phi)^2 - \Lambda)$$

$$S_{vis(hid)} = \int d^4x \sqrt{-g} e^{-\Phi} (L_{SM(hid)} - T_{vis(hid)})$$

Tuning conditions: $T_{vis} = -T_{hid} \leftrightarrow \Lambda < 0$ [7]

$$g_s^2 = e^{-\alpha|y|} ; ds^2 = e^{\frac{2}{3}\alpha|y|} (\eta_{\mu\nu} dx^\mu dx^\nu + dy^2) \leftarrow \text{Einstein frame [7]}$$

$z \sim e^{\alpha y/3} \Rightarrow$ polynomial warp factor + log varying dilaton

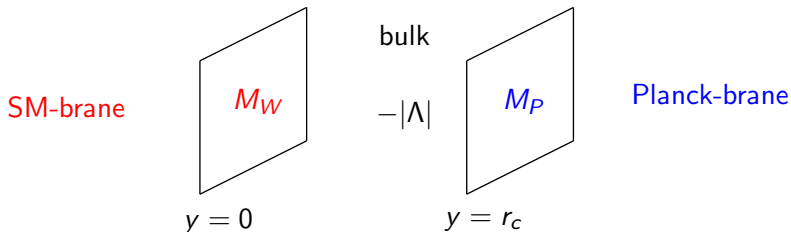

- exponential hierarchy: $g_s^2 = e^{-\alpha|y|}$ $M_P^2 \sim \frac{M_5^3}{\alpha} e^{\alpha r_c}$
- 4d graviton flat, KK gravitons localized near SM
- SM particles cannot be in the bulk

bulk gauge bosons: exp suppressed couplings

LST KK graviton phenomenology

- KK spectrum : $m_n^2 = \left(\frac{n\pi}{r_c}\right)^2 + \frac{\alpha^2}{4}$; $n = 1, 2, \dots$

⇒ mass gap + dense KK modes $\alpha \sim 1 \text{ TeV}$ $r_c^{-1} \sim 30 \text{ GeV}$

- couplings : $\frac{1}{\Lambda_n} \sim \frac{1}{(\alpha r_c) M_5}$

⇒ extra suppression by a factor $(\alpha r_c) \simeq 30$

- width : $1/(\alpha r_c)^2$ suppression $\sim 1 \text{ GeV}$

⇒ narrow resonant peaks in di-lepton or di-jet channels

- extrapolates between RS and flat extra dims ($n = 1$)

$\alpha \gtrsim (0.1 \text{ mm})^{-1} \sim 10^{-2} \text{ eV}$ from microgravity experiments

⇒ distinct experimental signals

Bounds on the LST parameter space

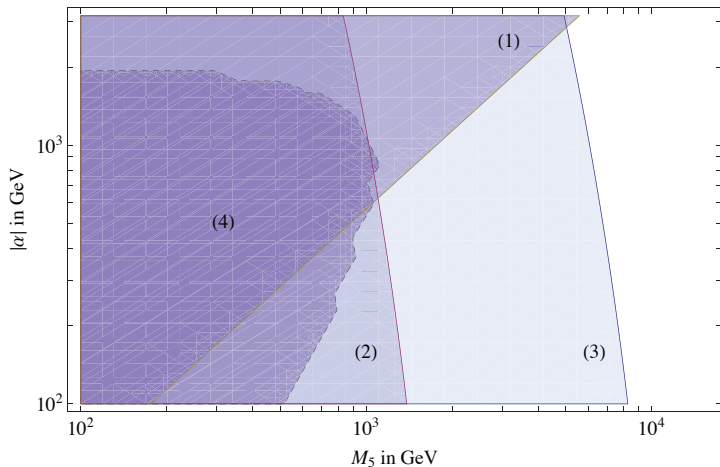

exclusion by (1) perturbativity (2) Tevatron with 5.4 fb^{-1} data

(3) LHC 14 TeV with 10 fb^{-1} (4) diphoton at Tevatron 5.4 fb^{-1}

Conclusions

Mass hierarchy \Rightarrow testing strings at the TeV ?

- Well motivated theoretical framework
with many testable experimental predictions
new resonances, missing energy
- Several realizations with different signatures
flat large extra dimensions, exp warped metrics,
tiny string coupling and linear dilaton background
- Stimulus for micro-gravity experiments and accelerator searches

But: - unification has to be dropped

- physics is radically changed above string scale