

# Experimental Physics at Hadron Collider

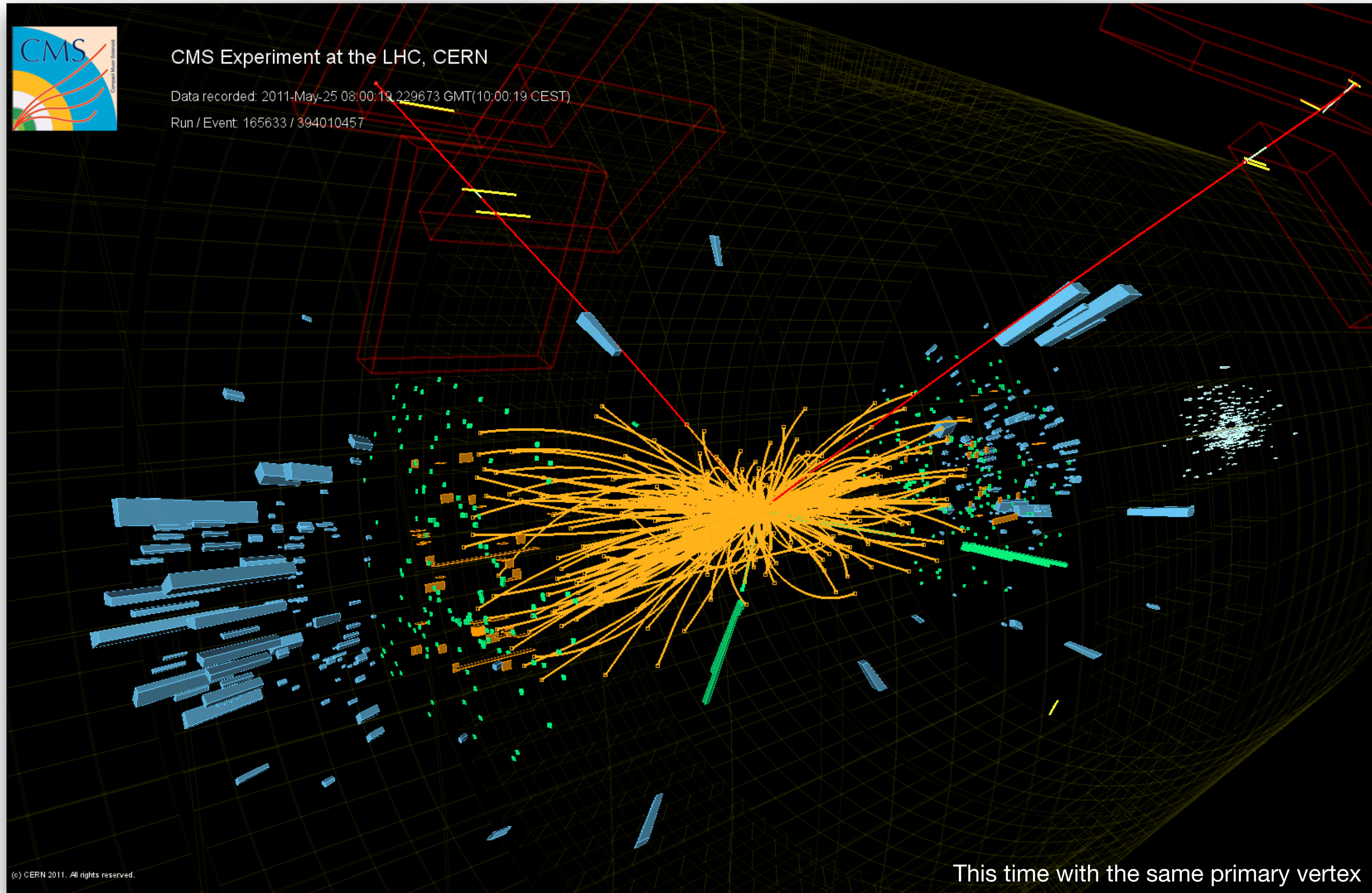

## Lecture 2

### *Standard Model*

### *Precision Measurements*

Marumi Kado  
Sapienza, Roma and LAL, Orsay

**CERN Summer Students Lectures**

July 19, 2022

## ***Lecture 1: Basic concepts, cross sections and QCD results***

- Preamble
- Context and mission of the LHC
- Fundamentals of hadron collisions
- Luminosity and total cross section
- Cross sections measurements
- Jet production measurements
- Measurement of the strong coupling constant

## ***Lecture 2: SM Measurements***

- The electroweak sector in a tiny nutshell
- Measurement of the weak mixing angle
- W mass measurement
- Top mass measurement
- Diboson production
- Global fit of the Standard Model

## ***Lecture 3: Higgs physics***

- The Higgs mechanism and Higgs production
- The discovery of the Higgs boson
- Precision Higgs physics with diboson channels
- Measuring the Yukawa couplings
- Measurement of Higgs properties
- Rare production and decays
- Global fit of the Standard Model (revisited)

## ***Lecture 4: Searching for new physics BSM and future Hadron Colliders***

- Introduction
- Searches for supersymmetry and Dark Matter
- Searches in non SUSY theories
- Searches for unconventional signatures
- EFT and high energy observables
- Outlook on future colliders
- Conclusions

# The electroweak sector in a tiny nutshell

**The elegant gauge sector** (governed by symmetries and only three parameters for EWK and one parameter for QCD at tree level)

$$\mathcal{L} = -\frac{1}{4} F_{\mu\nu} F^{\mu\nu} + i \bar{\psi} \not{D} \psi + h.c.$$

Yesterday discussed unbroken QCD with its massless gluons

**For the EW sector** it is another story... Gauge bosons and fermions have masses!

Higgs mechanism is needed!

The Higgs is for tomorrow, but the mere presence of a Higgs mechanism introduces predictive relations between gauge boson masses and their couplings.

Expanding a bit on the Electroweak sector:

$$SU(2)_L \otimes U(1)_Y \quad (\text{from the Higgs mechanism})$$

$\downarrow$                        $\downarrow$                        $\downarrow$   
 $g$                        $g'$                        $v$

The one-to-one relation between the couplings and the masses of gauge bosons (at Tree level) introducing the weak mixing angle!

$$\tan \theta_W = \frac{g'}{g}$$

$$m_W = \frac{gv}{2}$$
$$m_Z = \frac{gv}{2 \cos \theta_W}$$
$$m_\gamma = 0$$

No additional parameter for the masses of the Gauge bosons!

# The electroweak sector in a tiny nutshell

**The elegant gauge sector** (governed by symmetries and only three parameters for EWK and one parameter for QCD at tree level)

$$\mathcal{L} = -\frac{1}{4} F_{\mu\nu} F^{\mu\nu} + i \bar{\psi} \not{D} \psi + h.c.$$

Yesterday discussed unbroken QCD with its massless gluons

**For the EW sector** it is another story... Gauge bosons and fermions have masses!

Higgs mechanism is needed!

The Higgs is for tomorrow, but the mere presence of a Higgs mechanism introduces predictive relations between gauge boson masses and their couplings.

Expanding a bit on the Electroweak sector:

$$SU(2)_L \otimes U(1)_Y \quad (\text{from the Higgs mechanism})$$

$\downarrow$                        $\downarrow$                        $\downarrow$   
 $g$                        $g'$                        $v$

The one-to-one relation between the couplings and the masses of gauge bosons (at Tree level) introducing the weak mixing angle!

As a consequence, at tree level:

$$\rho \equiv \frac{m_W^2}{m_Z^2 \cos^2 \theta_W} = 1$$

This parameter can be (and has been) measured experimentally well before the discovery of the Higgs.

# The Drell Yan $Z/\gamma^*$ production

Measurement of the weak mixing angle

# The Sp̄S

The Sp̄S (Super Proton anti-Proton Synchrotron) operated with collisions at 900 GeV from 1981 to 1991.

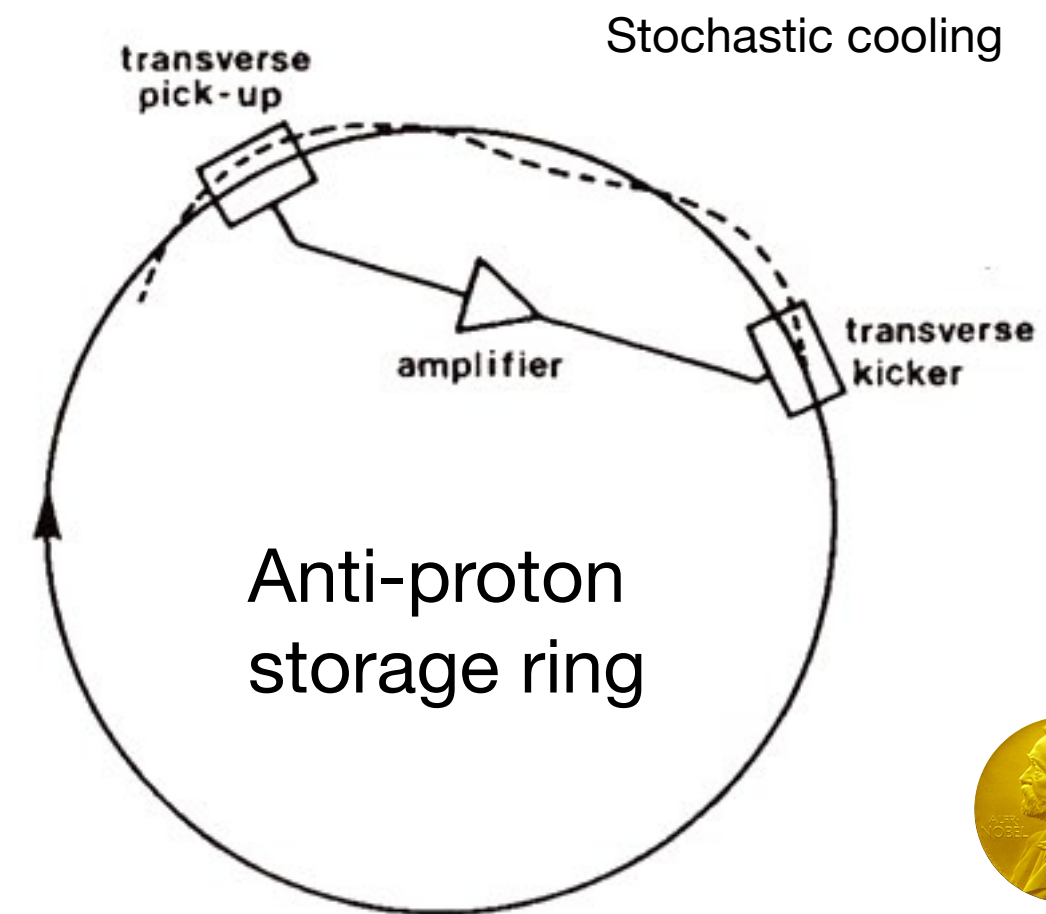

1984

Discovery of the W and Z bosons  
Carlo Rubbia, Simon Van der Meer

UA1

UA2

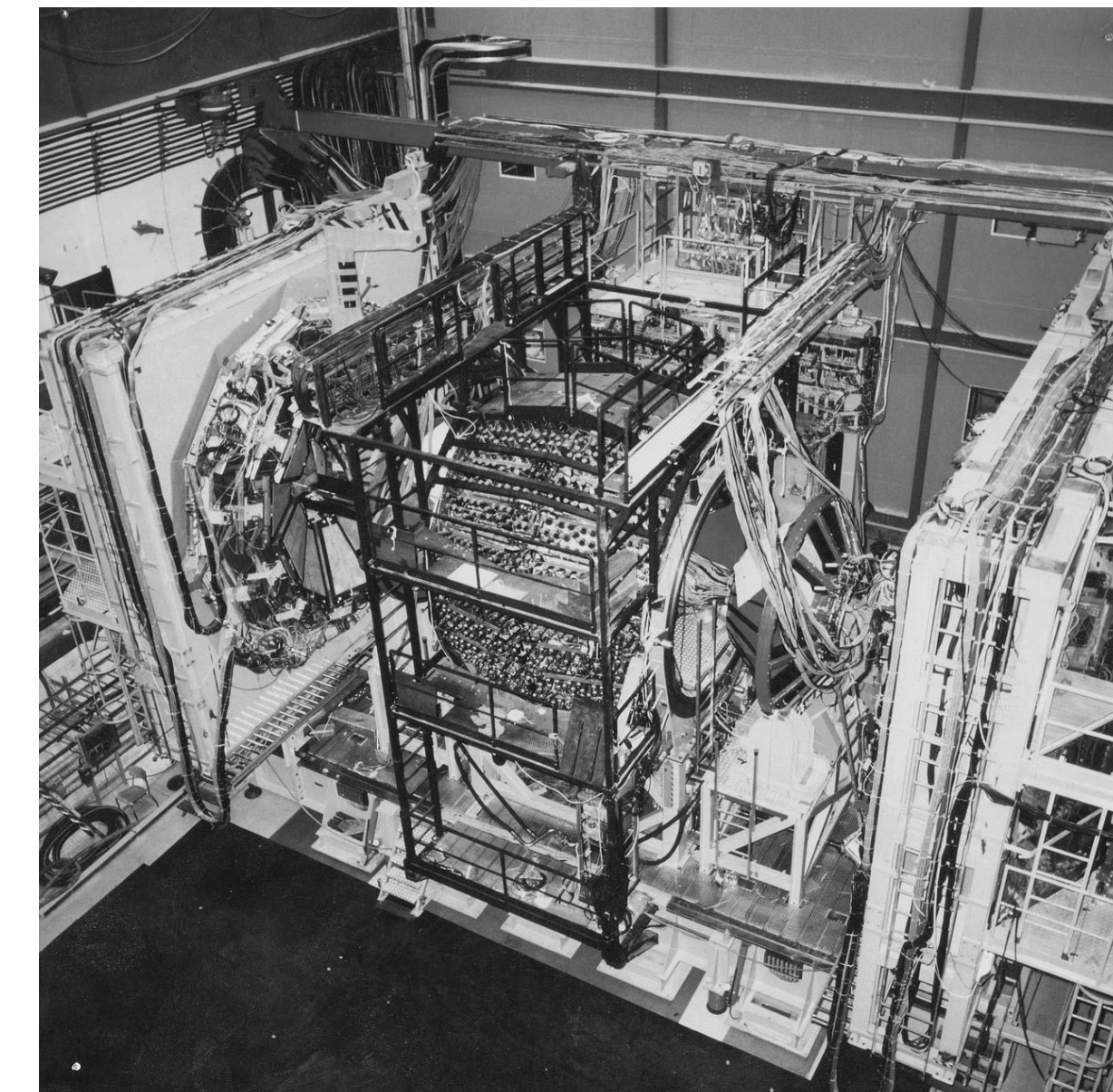
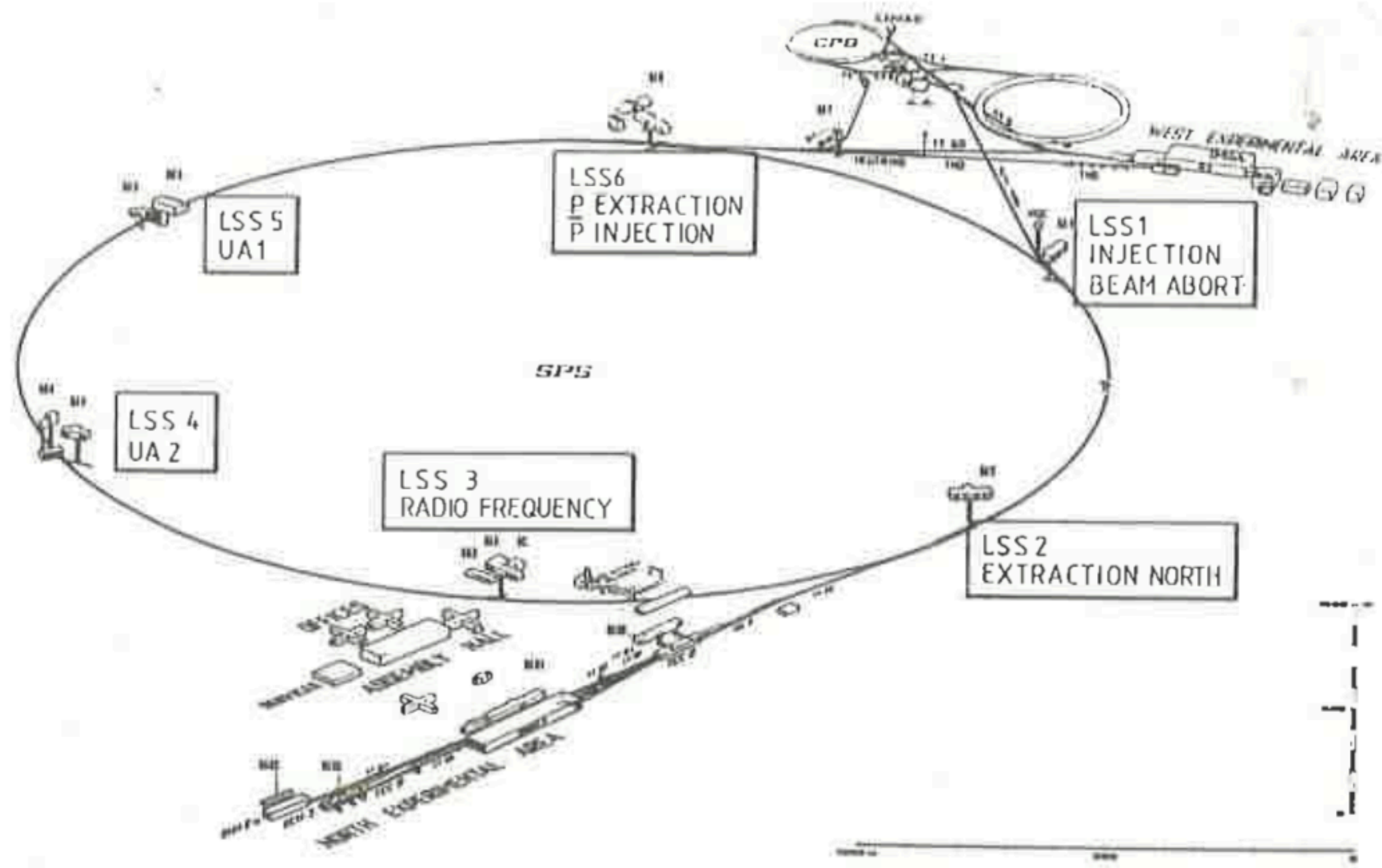

# An SppS Legacy

The discovery of the W and Z bosons

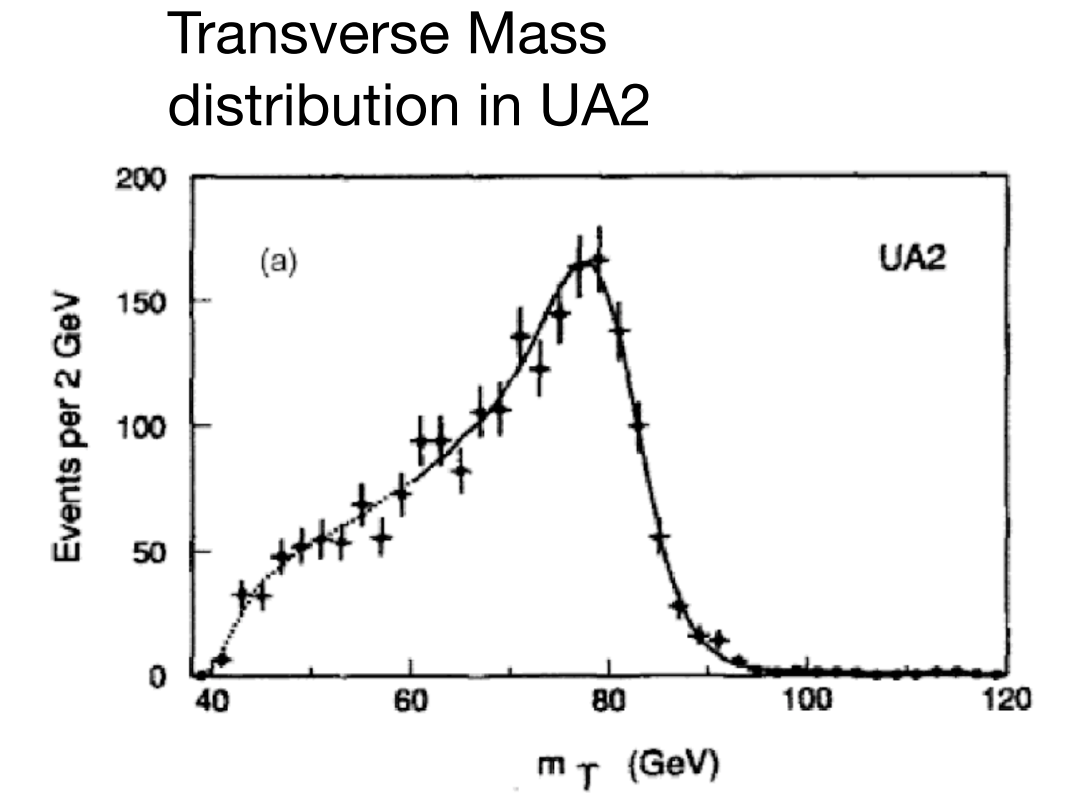
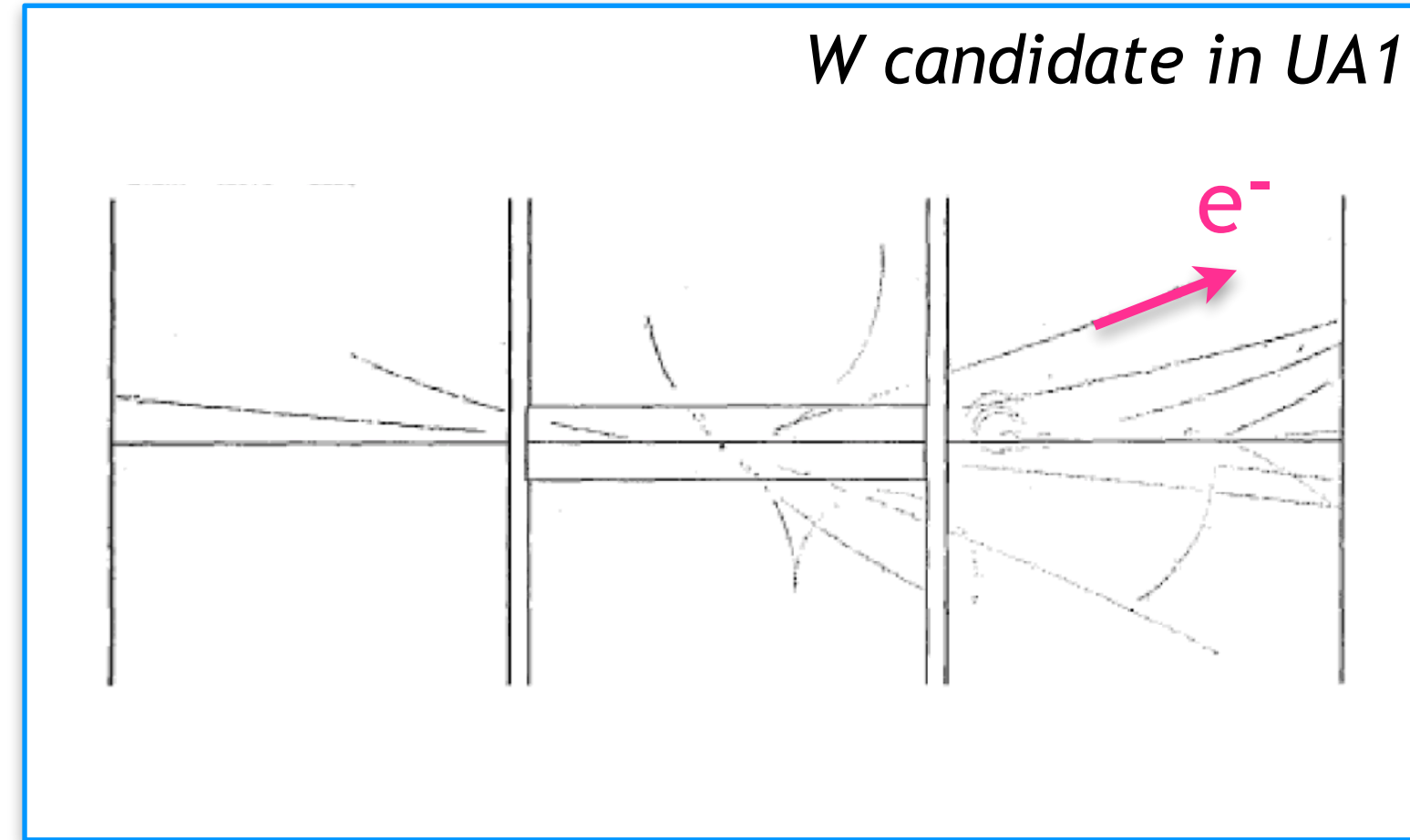
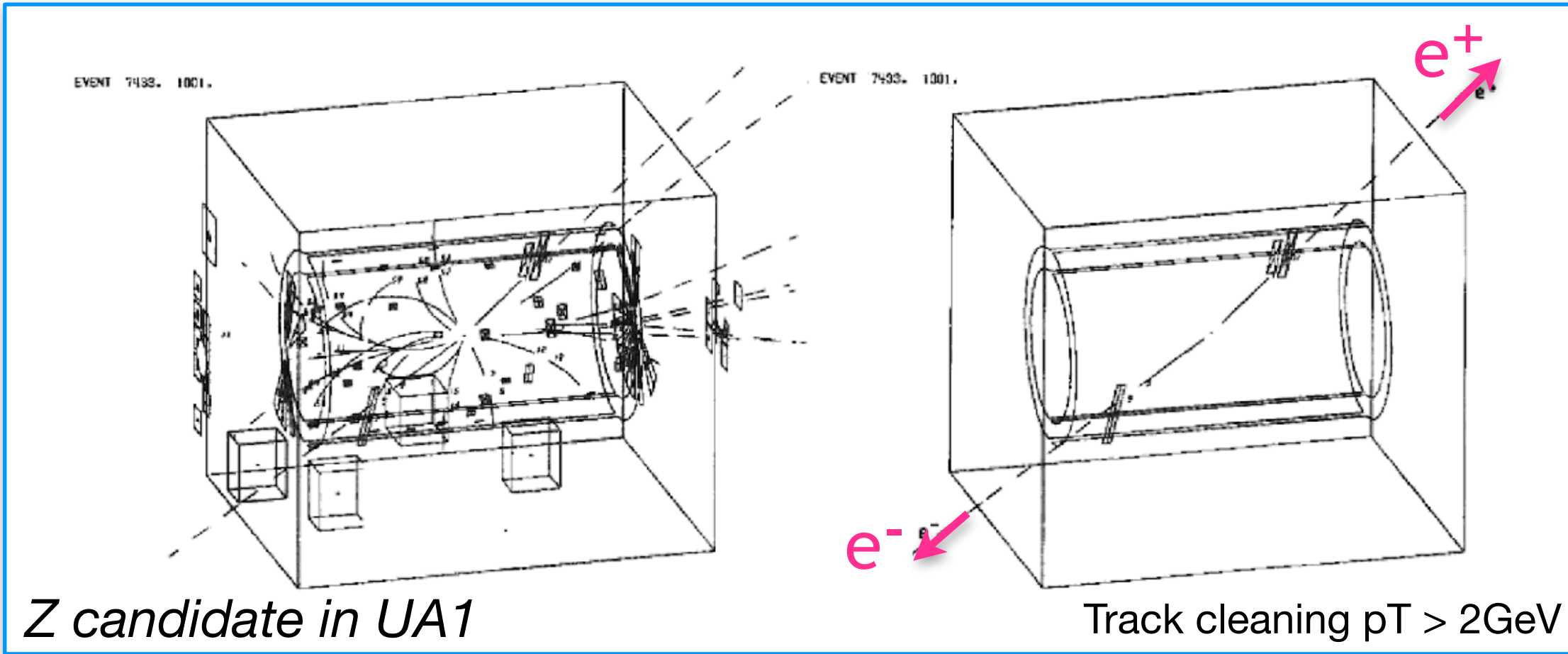

$$m_T^2 = m^2 + p_x^2 + p_y^2$$

Altogether O(100) Z events

Altogether O(1000) W events

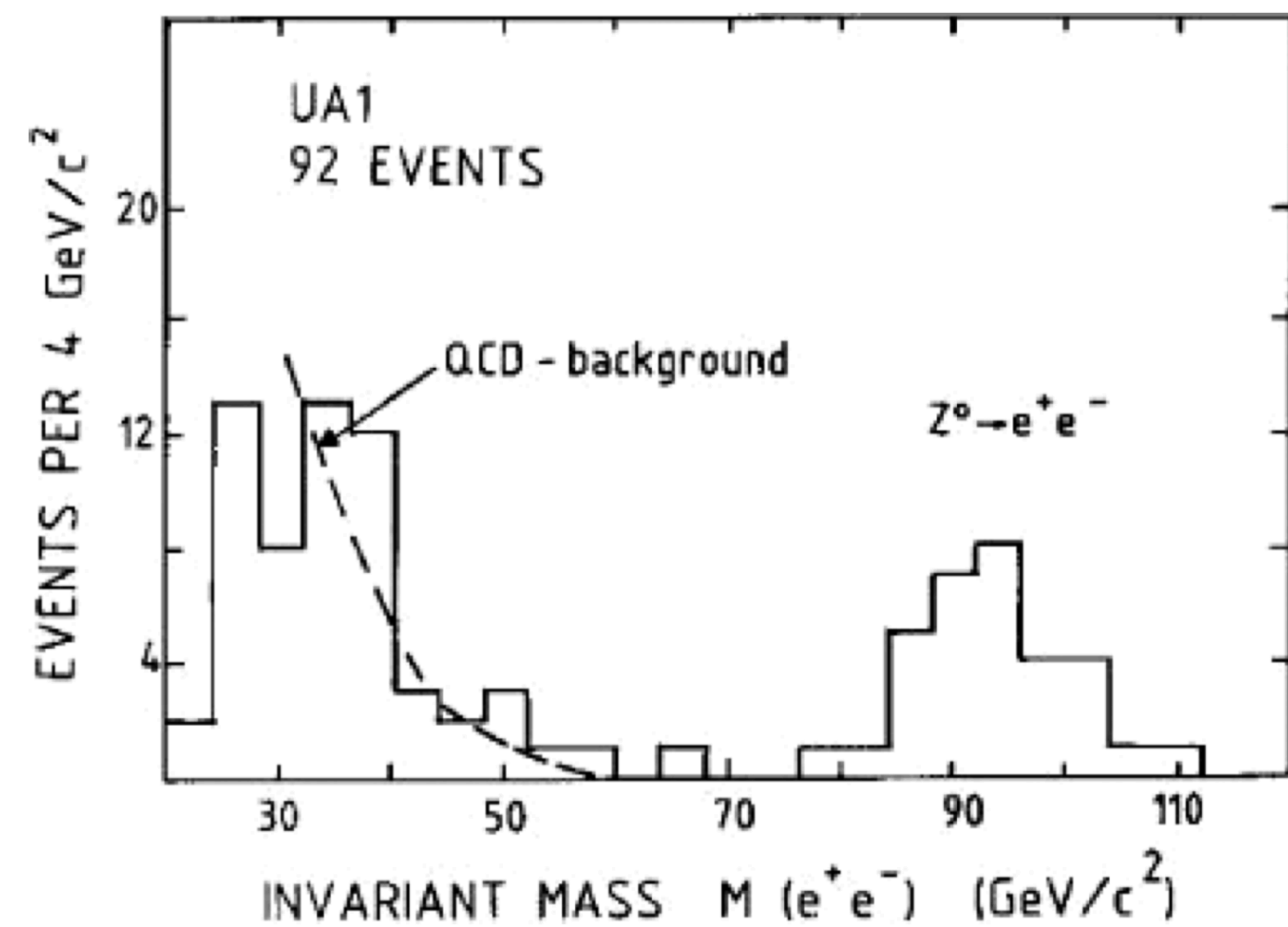

At SppS W production dominated by valence quarks

W polarised in the anti-proton direction.

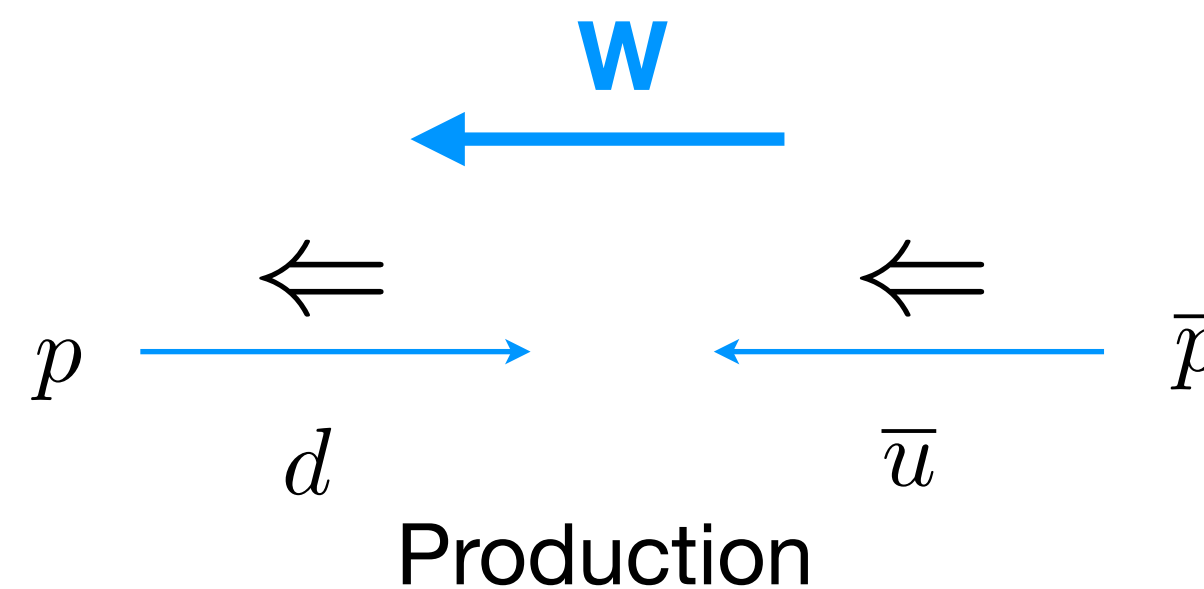

# An SppS Legacy

The discovery of the W and Z bosons

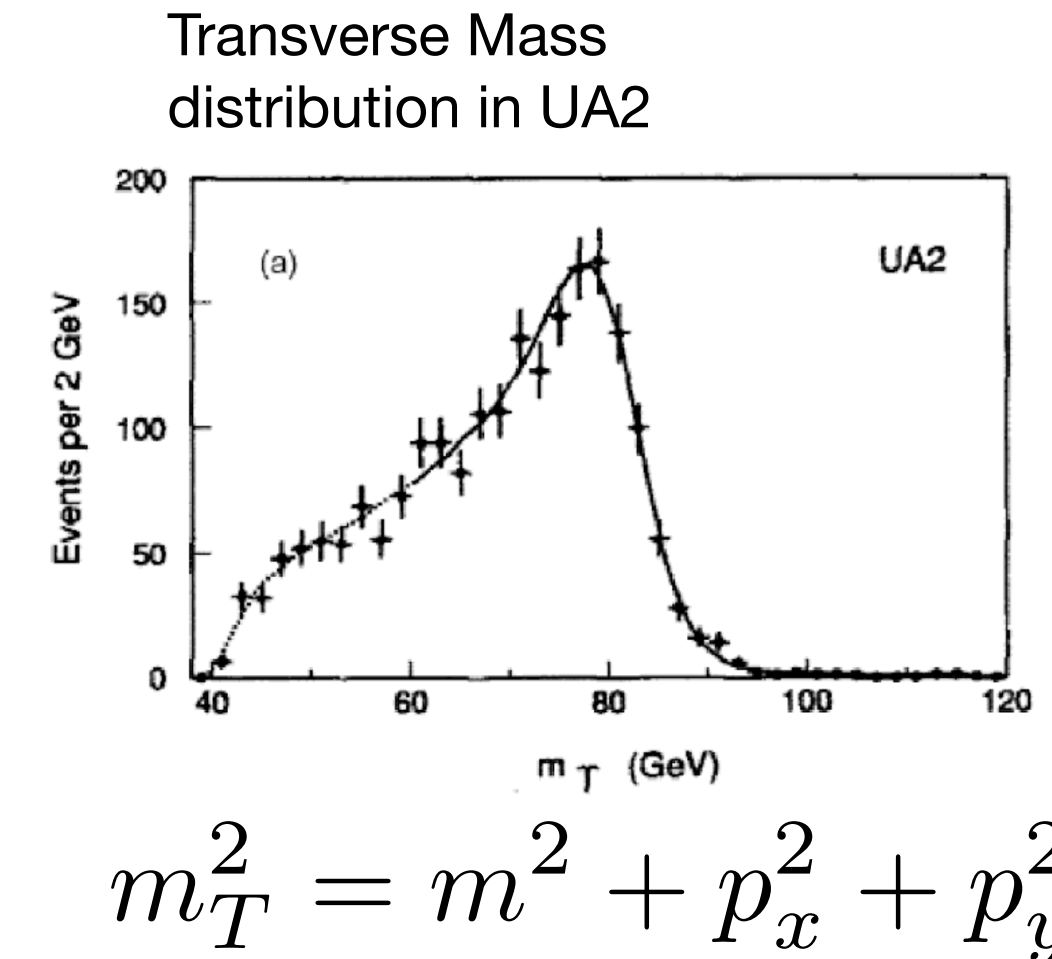
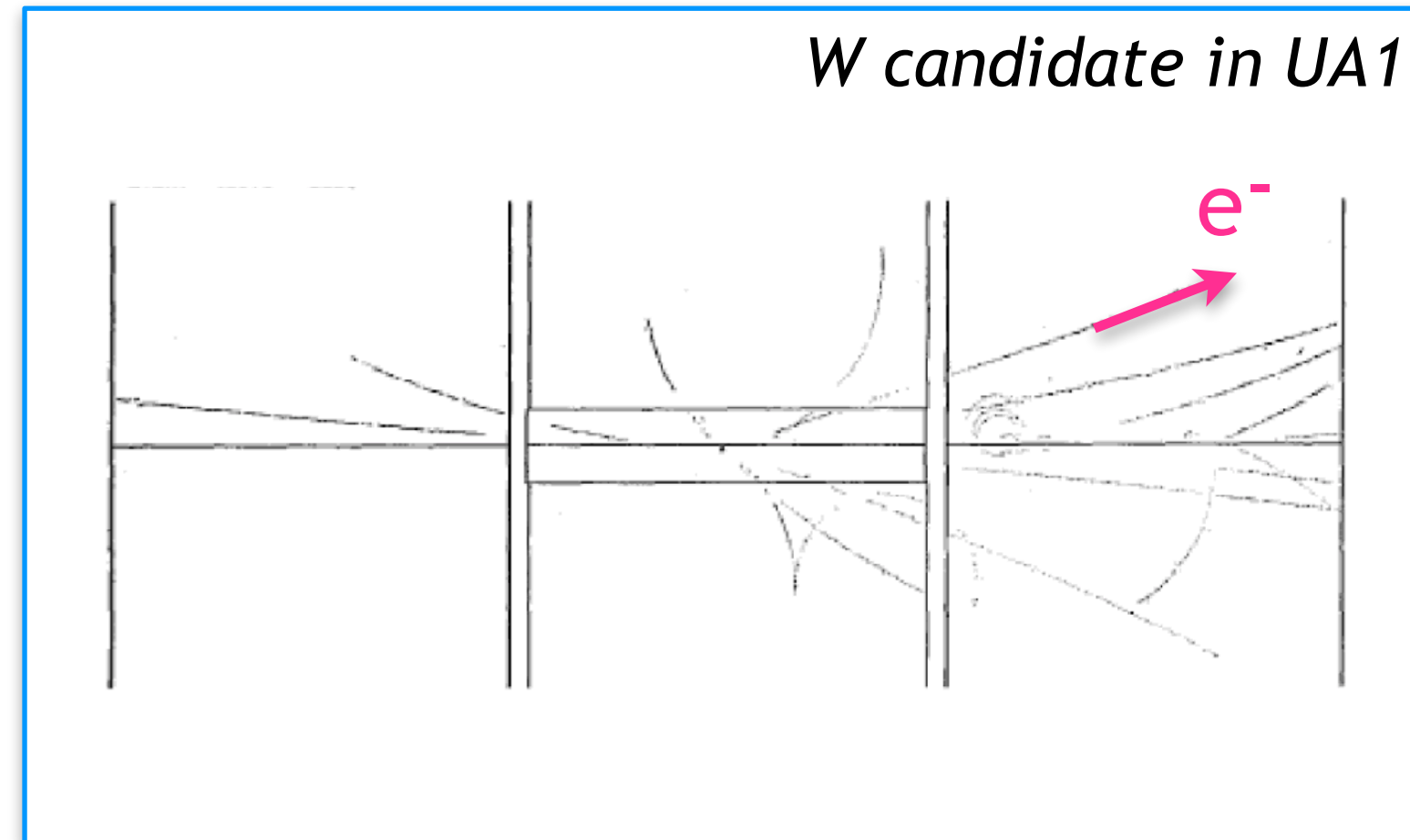
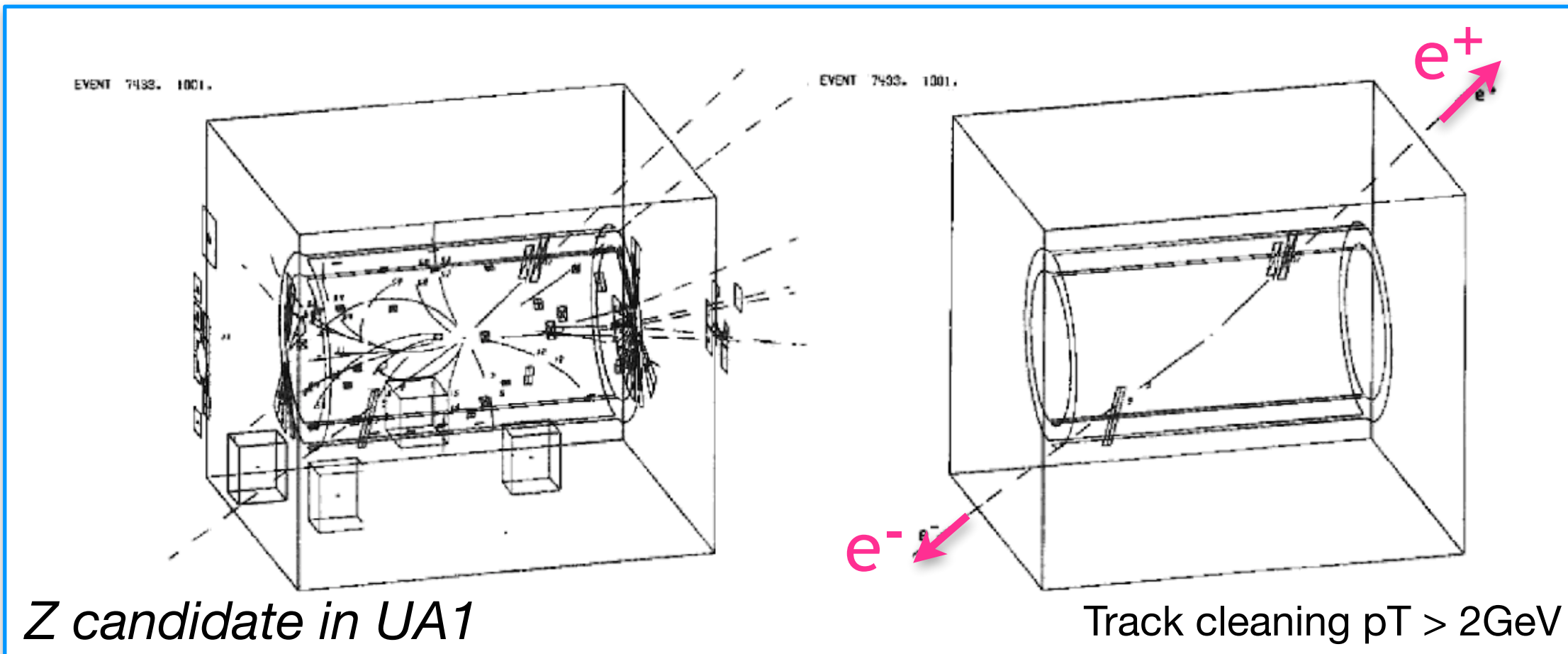

## Altogether O(100) Z events

Already very important measurements:

$M_Z = 91.5 \pm 1.2 \pm 1.7$ (GeV)	(UA1)
$M_W = 81.0 \pm 0.8 \pm 1.3$ (GeV)	(UA2)
$\rho = 1.004 \pm 0.052$	(UA1)
$\sin^2 \theta_W = 0.226 \pm 0.014$	(UA1)

## Altogether O(1000) W events

At SppS W production dominated by valence quarks

W polarised in the anti-proton direction.

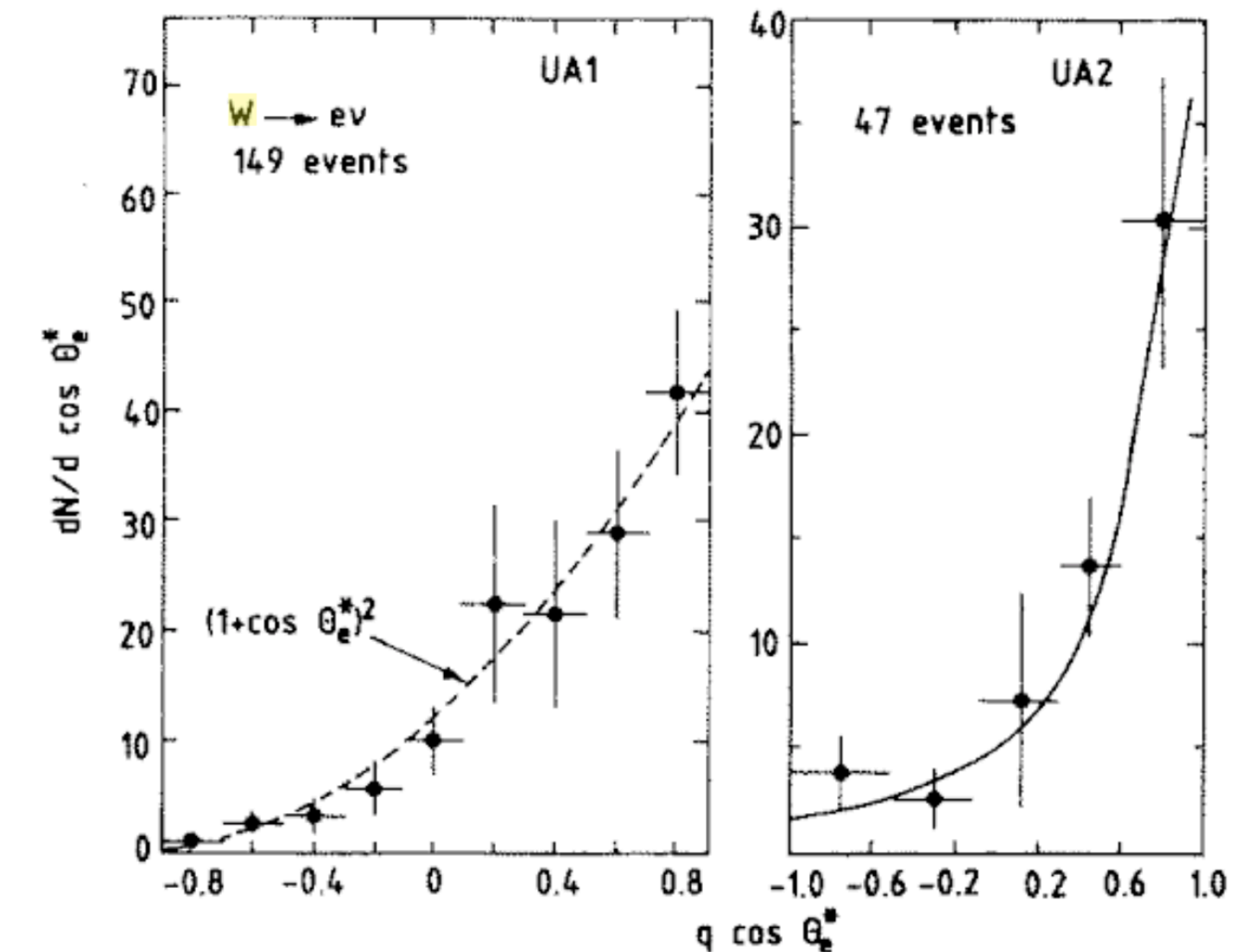
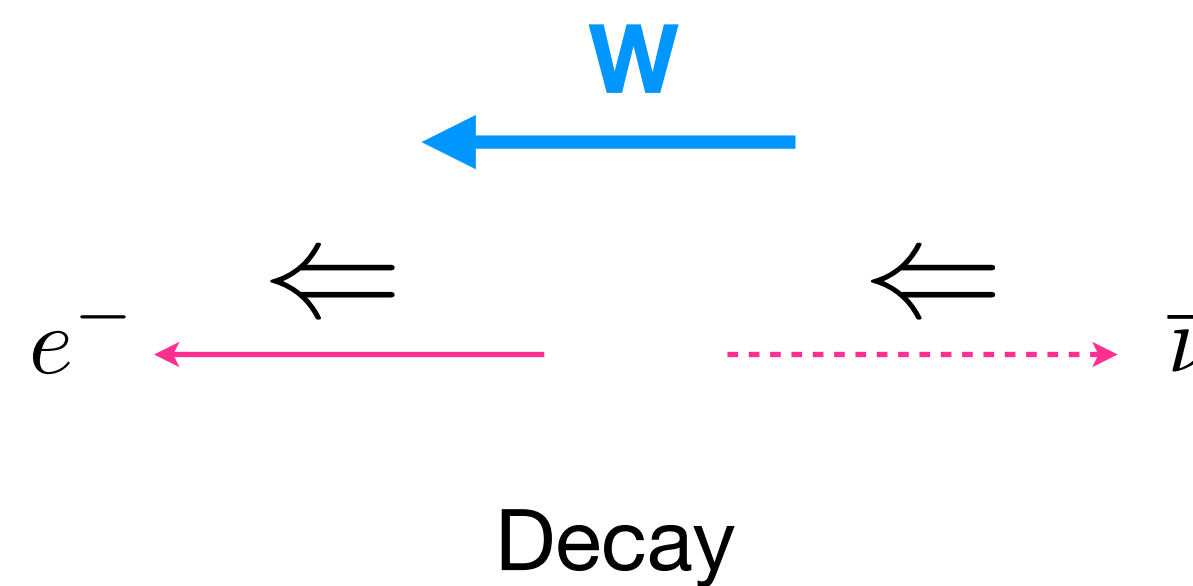



# The di-lepton mass spectrum at LHC

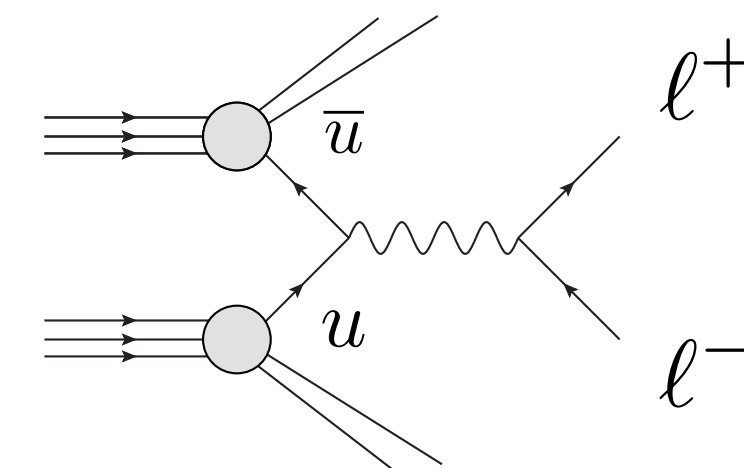
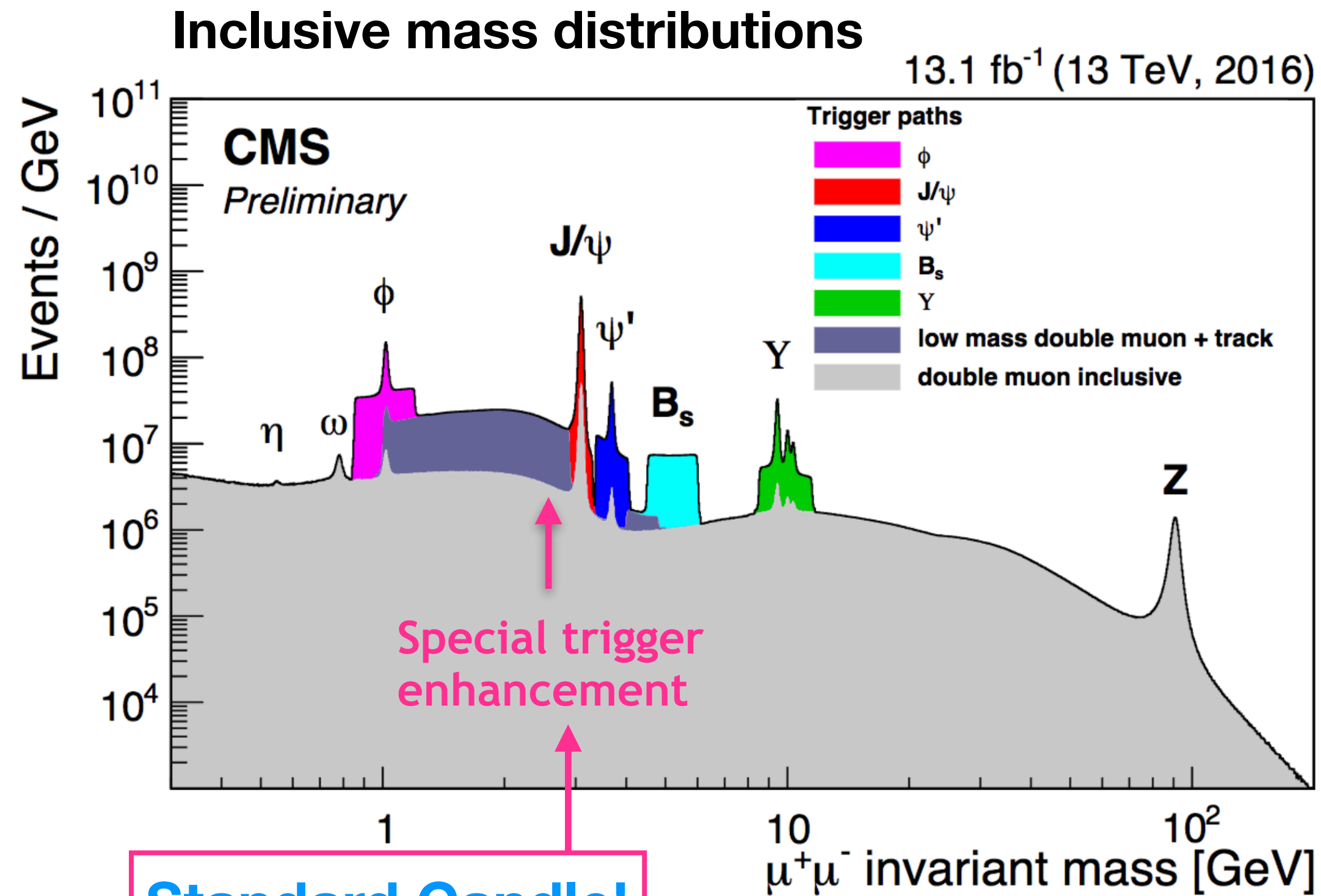

Z, J/Psi and Upsilon in electrons and muons are extremely important standard candles for calibration.

**Standard Candle!**

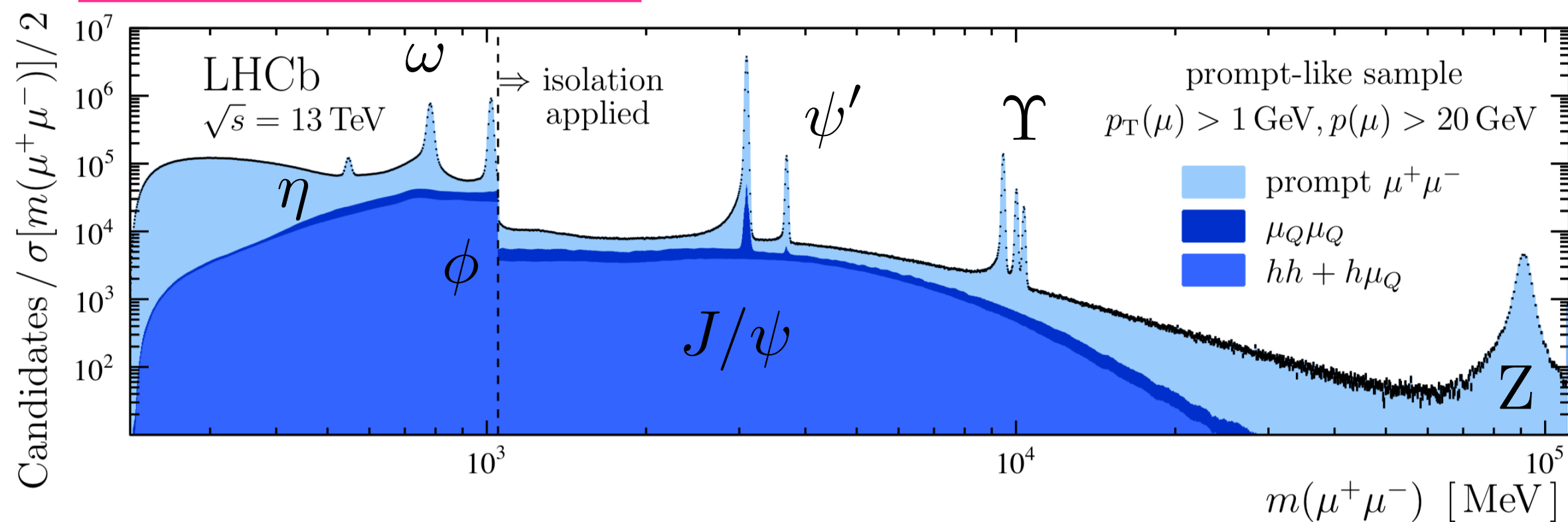
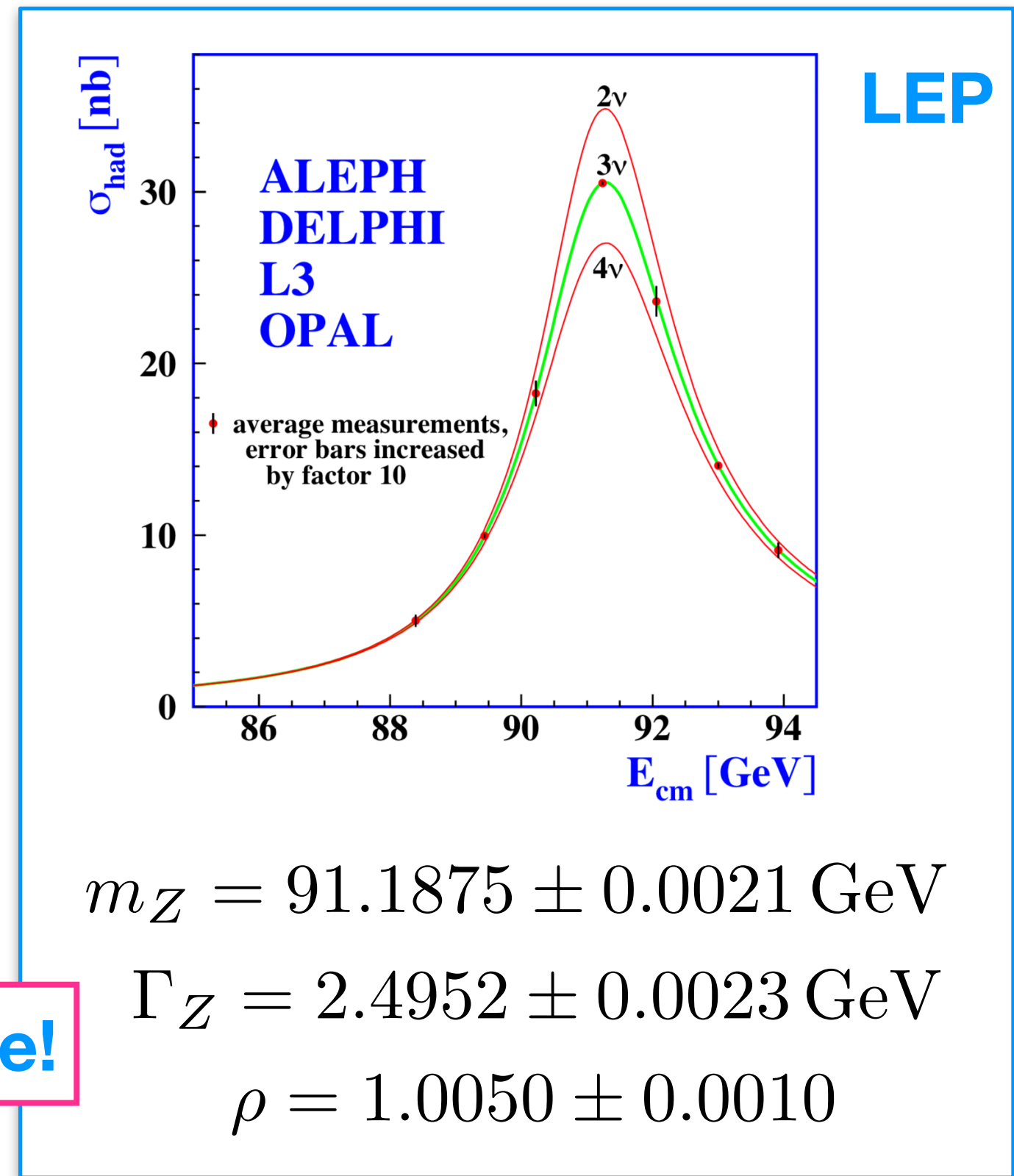

An exclusive analysis scrutinising the Bs mass region

$$\text{Br}(B_s^0 \rightarrow \mu^+ \mu^-) = (3.65 \pm 0.23) \times 10^{-9}$$

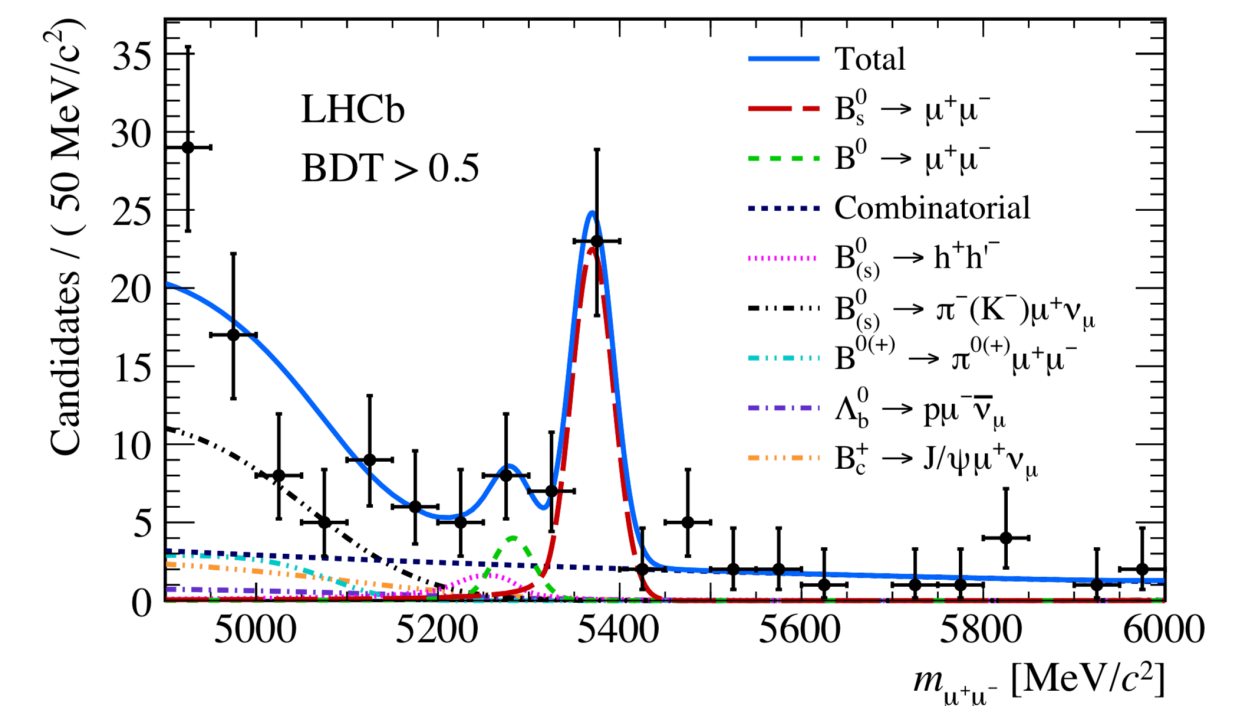

# Composition of Drell Yan production

## Flavour content of the $pp \rightarrow Z, W^\pm$ process

In pp collisions a sizeable charge asymmetry due to the valence quarks (2u vs 1d) in the proton (difference reduces with the COM energy as W production occurs at lower x).

For 13 TeV collisions predictions are:

$$\sigma_{W^-} = 8.54^{+0.21}_{-0.24} \text{ (PDF)} \pm 0.16 \text{ (TH)} \text{ nb}$$

$$\sigma_{W^+} = 11.54^{+0.32}_{-0.31} \text{ (PDF)} \pm 0.22 \text{ (TH)} \text{ nb}$$

$$\sigma_Z = 1.89 \pm 0.05 \text{ (PDF)} \pm 0.04 \text{ (TH)} \text{ nb}$$

**Note:** PDF uncertainties are dominant.

Overall this process is O(3M) times smaller than the total inelastic cross section.

*Still O(2) Billion W boson events produced !!*

flavour decomposition of W cross sections

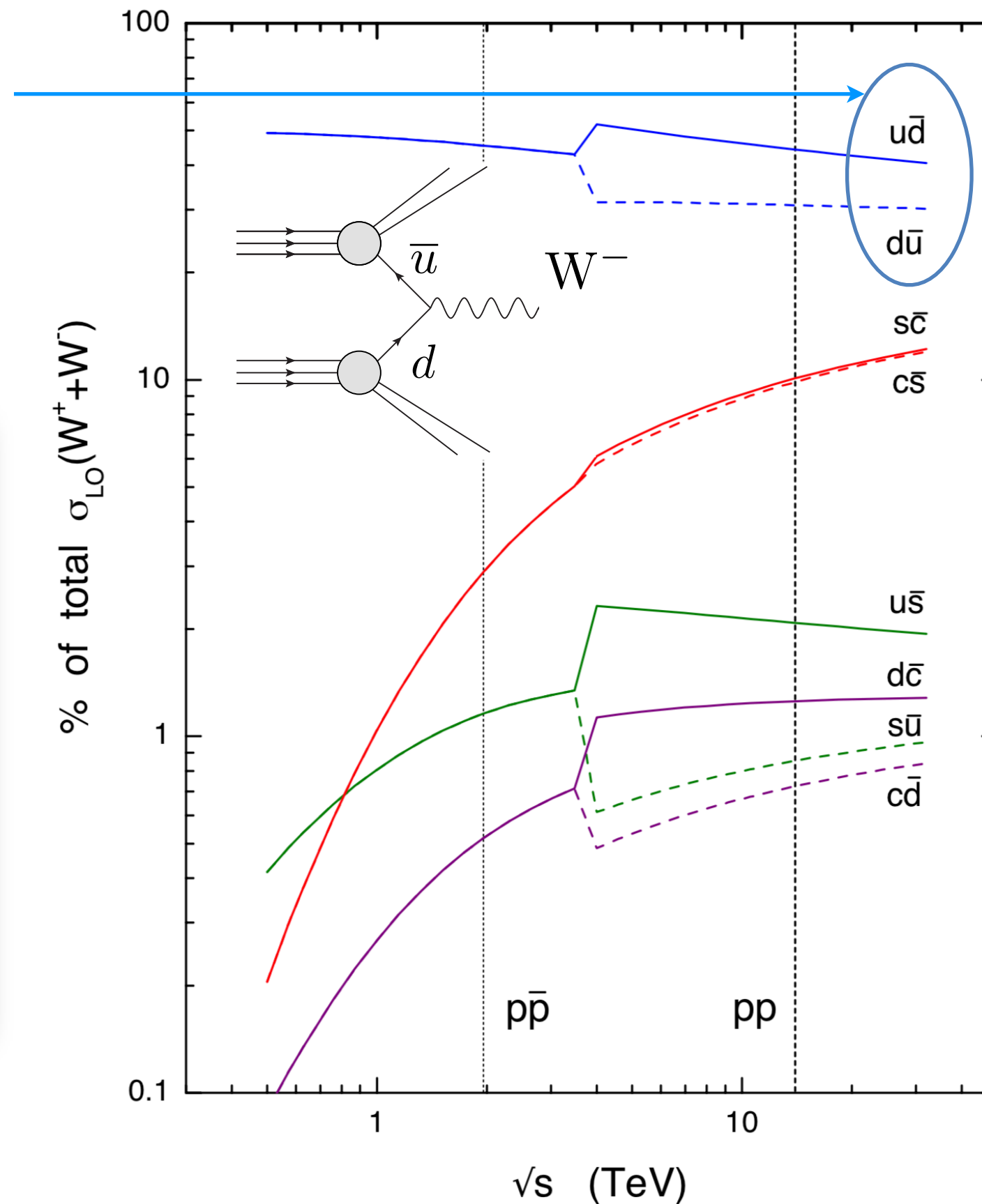

Typically in pp in leptonic modes

$$\ell = e, \mu, \tau$$

$$\text{Br}(W \rightarrow q\bar{q}') \sim 70\%$$

$$\text{Br}(W \rightarrow \ell^\pm \nu) \sim 10\%$$

flavour decomposition of Z<sup>0</sup> cross sections

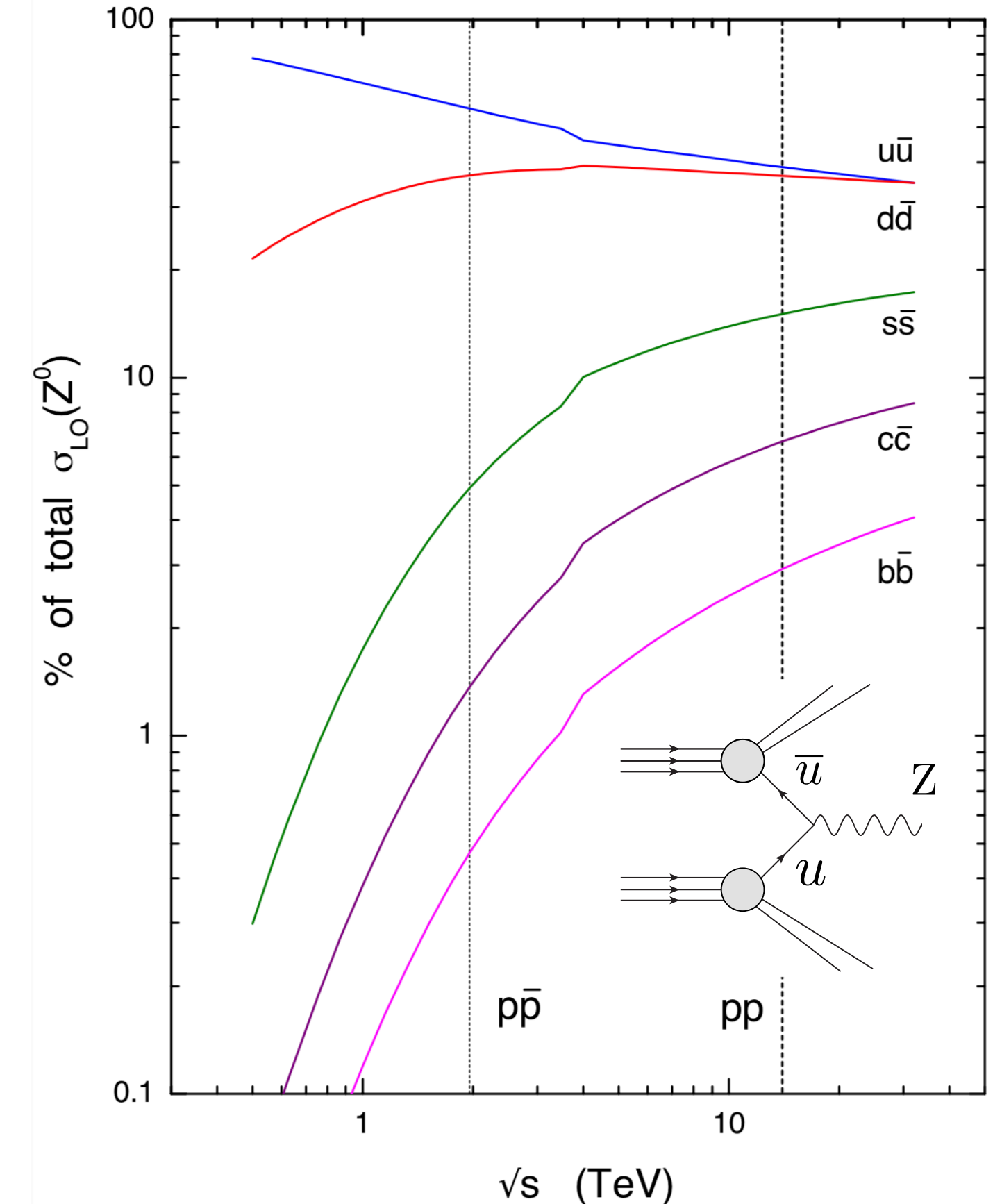

$$\text{Br}(Z \rightarrow \nu\bar{\nu}) \sim 20\%$$

$$\text{Br}(Z \rightarrow q\bar{q}) \sim 70\%$$

$$\text{Br}(Z \rightarrow \ell^+ \ell^-) \sim 3\%$$

# Formalism of Weak Mixing Angle Measurements

A closer look at the **Z** coupling to fermions (obtained when mixing the  $B^\mu$  field with the  $W_3^\mu$  fields):

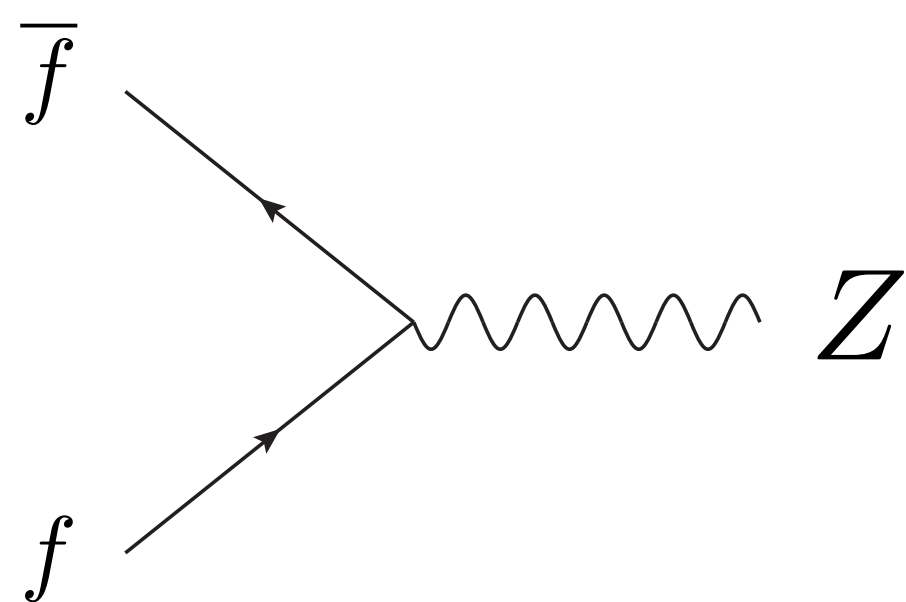

$$\frac{g}{2 \cos \theta_W} \bar{f} \gamma^\mu (R_f (1 + \gamma^5) + L_f (1 - \gamma^5)) f Z_\mu$$

$$a_f = (L_f - R_f)/2 = T_f^3$$

$$v_f = (L_f + R_f)/2 = T_f^3 - 2Q_f \sin^2 \theta_W$$

Family	$T$	$T_3$	$Q$
$\begin{pmatrix} \nu_e \\ e \end{pmatrix}_L$	1/2	+1/2	0
$\begin{pmatrix} \nu_\mu \\ \mu \end{pmatrix}_L$		-1/2	-1
$\begin{pmatrix} \nu_e R \\ e_R \end{pmatrix}$	0	0	0
$\begin{pmatrix} \nu_\mu R \\ \mu_R \end{pmatrix}$	0	0	-1
$\begin{pmatrix} \nu_\tau \\ \tau \end{pmatrix}_L$	1/2	+1/2	+2/3
$\begin{pmatrix} \nu_\tau \\ \tau \end{pmatrix}_L$		-1/2	-1/3
$\begin{pmatrix} u_R \\ d_R \end{pmatrix}$	0	0	+2/3
$\begin{pmatrix} c_R \\ s_R \end{pmatrix}$	0	0	-1/3
$\begin{pmatrix} t_R \\ b_R \end{pmatrix}$	0	0	-1/3

There is an explicit asymmetry between the coupling of the Z to left and right handed fermions!

See full calculation in Lecture 29 of [Part. Phys. Lectures](#) (Roma Sapienza)

# Formalism of Weak Mixing Angle Measurements

Taking into account radiative corrections the above expressions can be replaced by effective couplings and mixing angles:

$$g_{af} = \sqrt{\rho} T_f^3$$

$$g_{vf} = \sqrt{\rho} (T_f^3 - 2Q_f \sin^2 \theta_W^{eff})$$

This allows to quantify the “**polarisation asymmetry**” parameter in the following way:

$$A_f \equiv 2 \frac{g_{vf} / g_{af}}{1 + (g_{vf} / g_{af})^2}$$

Which is related to the effective weak mixing angle through (see full calculation [here](#)):

$$(\sin^2 \theta_W^{eff})^f = \frac{1}{4|Q_f|} (1 - g_{vf} / g_{af})$$

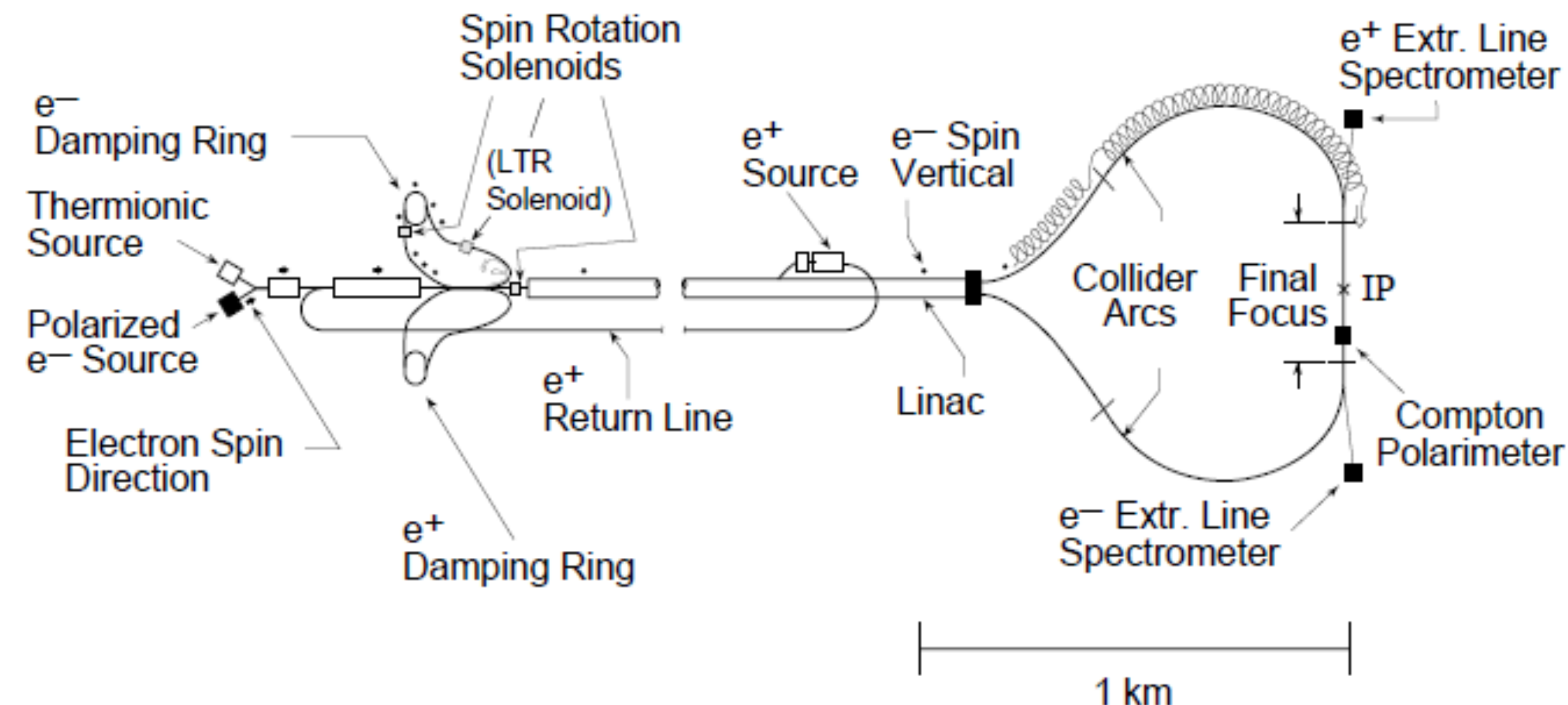

## SLC 1988 - 1998

Linear e<sup>+</sup>e<sup>-</sup> collider w/ longitudinal electron polarisation (at ~91 GeV).

$$A_{LR} \equiv \frac{\sigma_L - \sigma_R}{\sigma_L + \sigma_R} = A_e$$

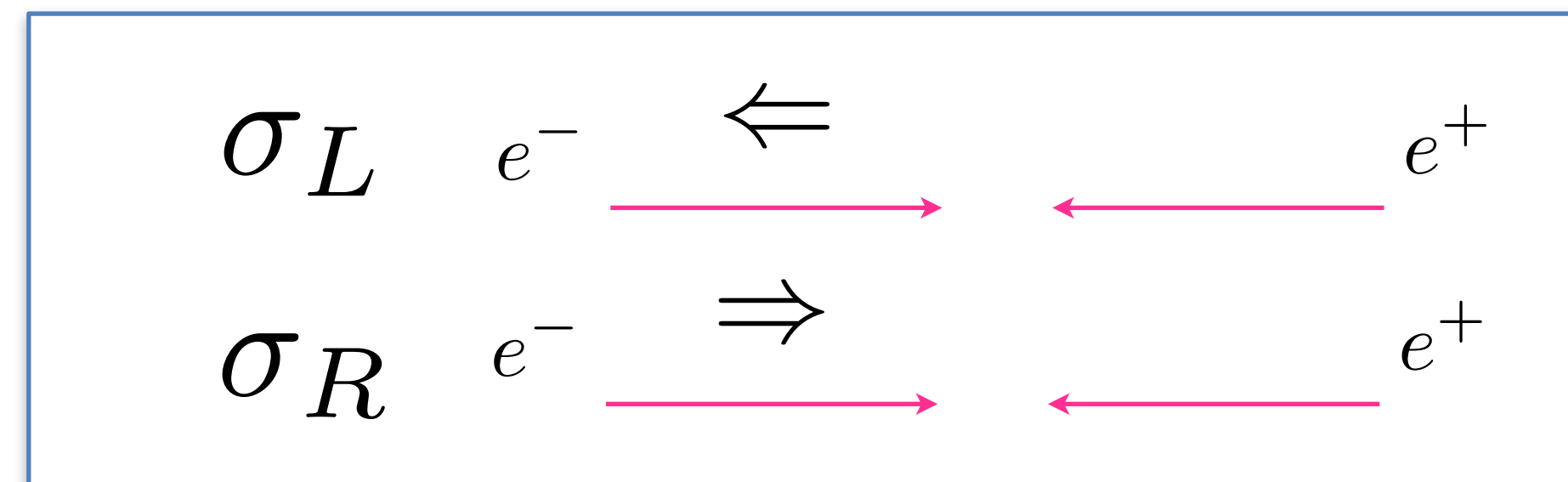

$$A_e \sim 15\%$$

# Forward Backward Asymmetry in Unpolarised Collisions

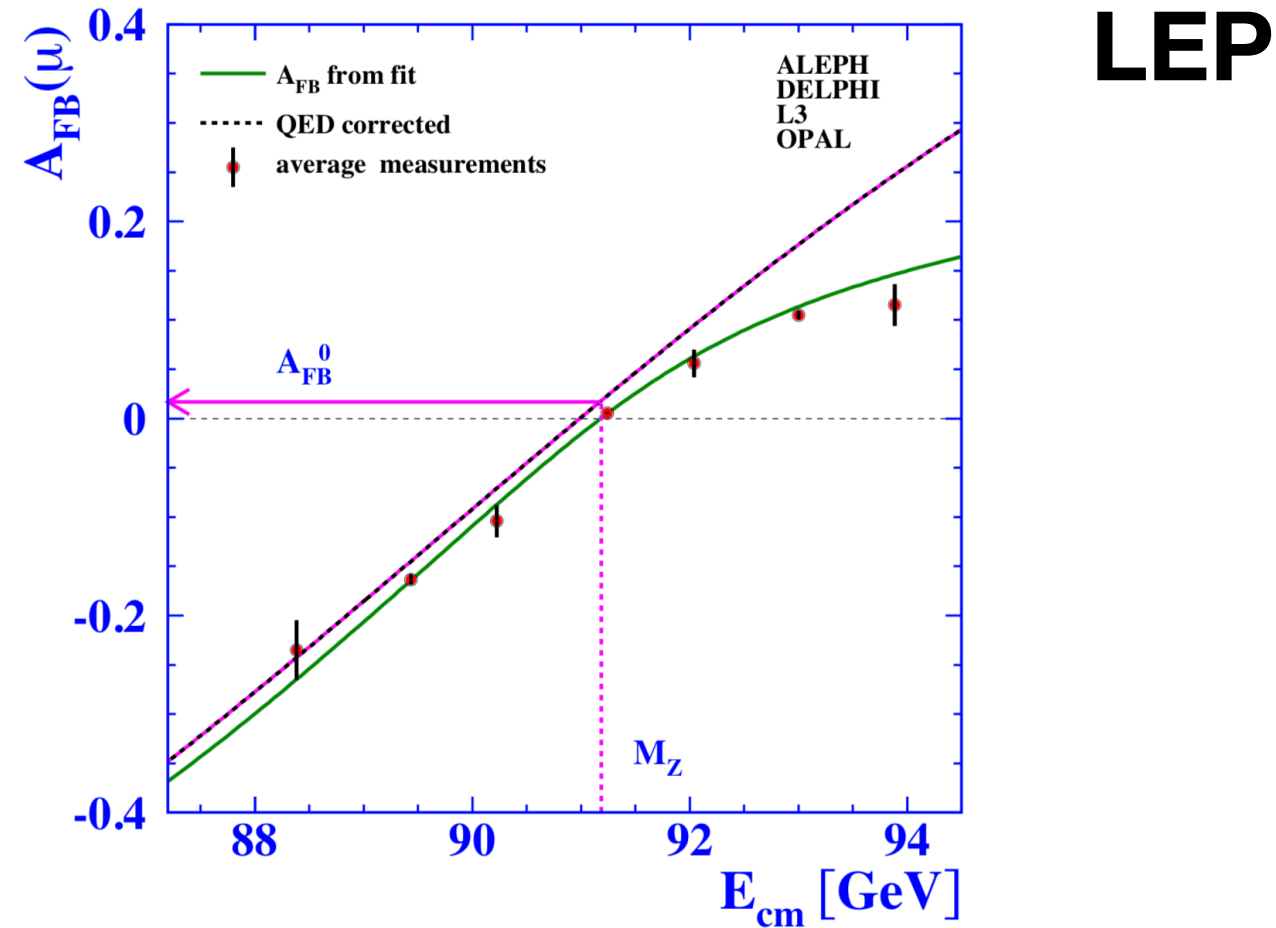

Forward-Backward asymmetry at LEP

On peak, effect is very small, off peak measurement are also extremely crucial.

At the Z pole:  $\mathcal{A}_{FB}^0 = 3\mathcal{A}^e \mathcal{A}^f$

At the LHC the situation is much more intricate: what is the direction of the quark with respect to the direction of the anti-quark?

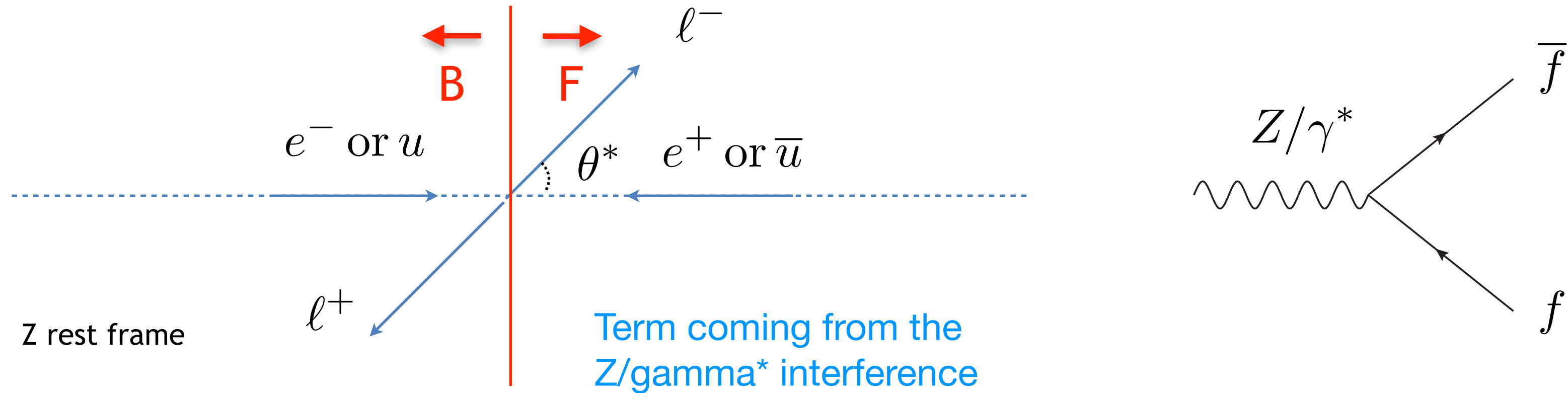

$$\frac{d\sigma}{d\cos\theta^*} = \frac{4\pi\alpha^2}{3\hat{s}} \left[ \frac{3}{8}A(1 + \cos^2\theta^*) + B\cos\theta^* \right] \quad B \propto A_{FB} = \frac{\sigma_F - \sigma_B}{\sigma_F + \sigma_B}$$

$$\frac{d\sigma}{d\cos\theta^*} \propto ((g_{ve}^2 + g_{ae}^2)(g_{vf}^2 + g_{af}^2)(1 + \cos^2\theta^*) + 8g_{ve}g_{ae}g_{vf}g_{af}\cos\theta^*)$$

- The COM frame at LEP is essentially the detector frame, at the LHC the choice of frame is less obvious.

- At LHC because of the valence PDFs the momentum of valence quarks is larger and indicates the direction of the quark! The forward and backward asymmetry can be quantified in the same way.

# Measurement of effective weak mixing angle at the LHC

Once the reference frame is defined, the Forward backward asymmetry can be straightforwardly measured, however defining the reference frame and expressing the asymmetry in terms of the effective mixing angle is less straightforward but done.

The size of the asymmetry as a function of the di-lepton mass will depend on the rapidity of the system (how boosted it is in the z direction). Where a high boost generates less ambiguity on the initial direction of the charge (from valence quarks).

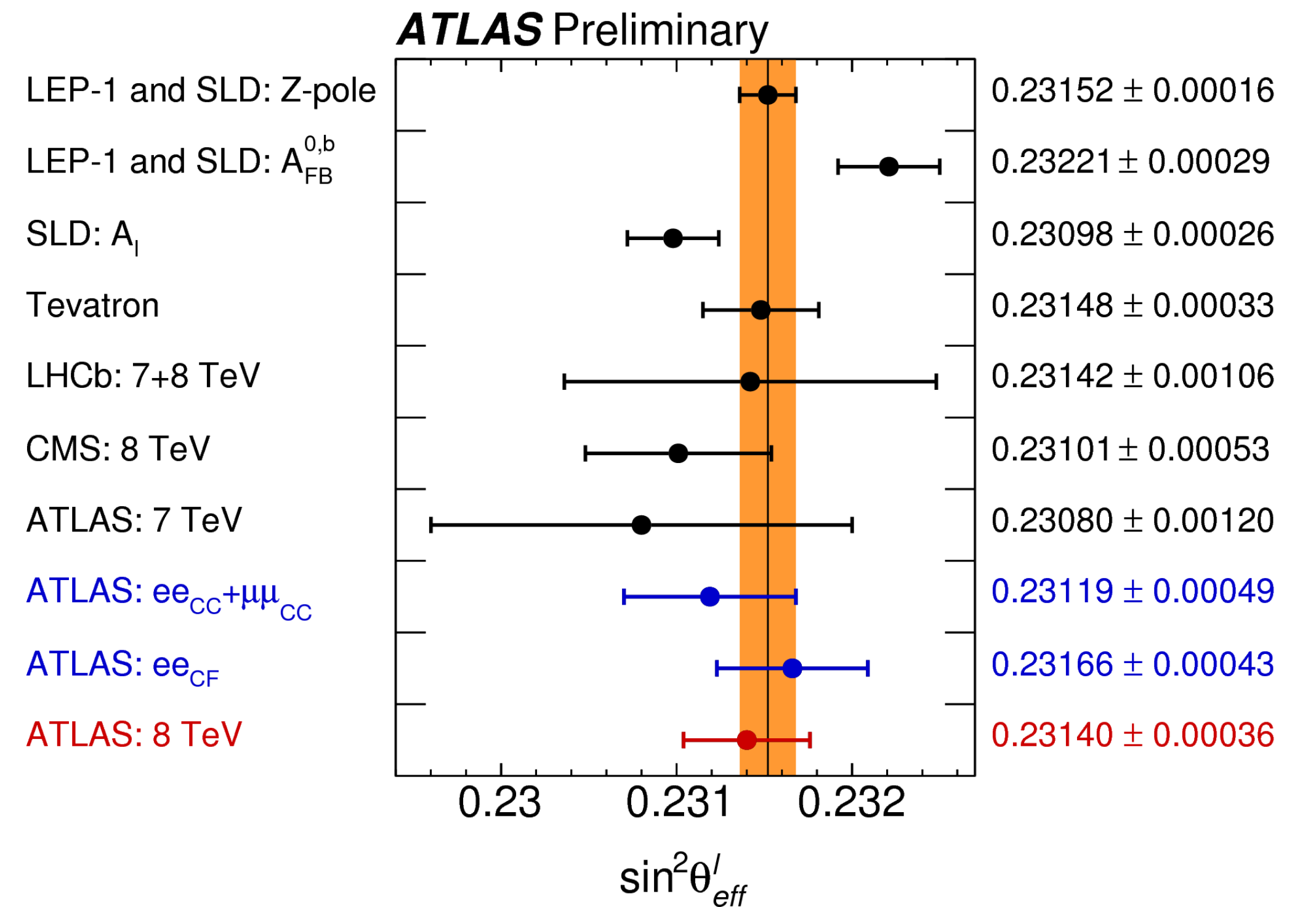
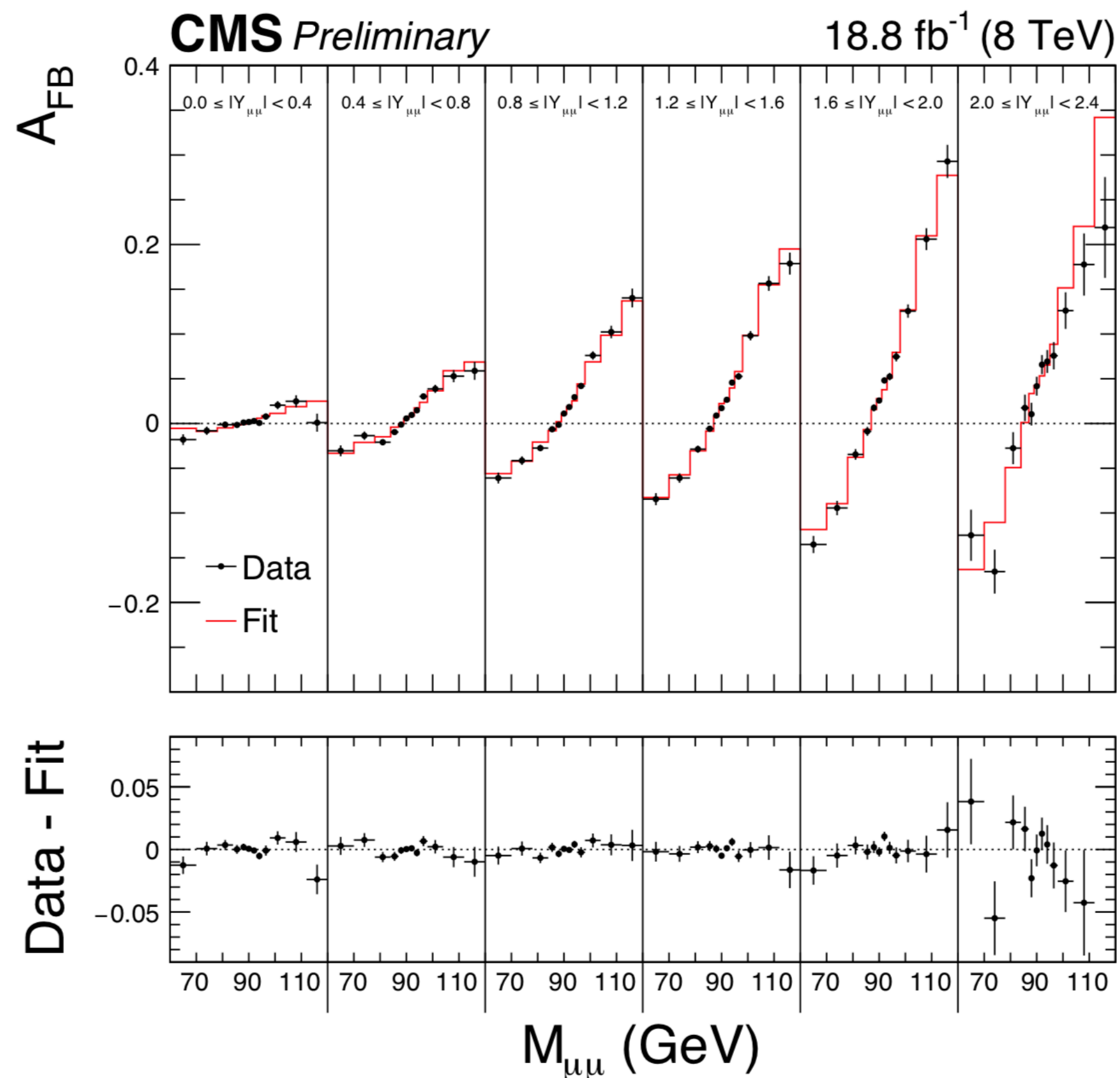

Latest ATLAS result using forward electrons up to eta of 4.9.

$$\sin^2 \theta_{eff}^l = 0.23140 \pm 0.00021 \text{ (stat)} \pm 0.00024 \text{ (PDFs)} \pm 0.00016 \text{ (syst)}$$

# **W boson production**

Measurement of the W boson mass

$$pp \rightarrow W \rightarrow \mu \nu_{\mu}$$

$\mu$

Run: 183081

Event: 101291517

2011-06-05 17:09:02 CEST

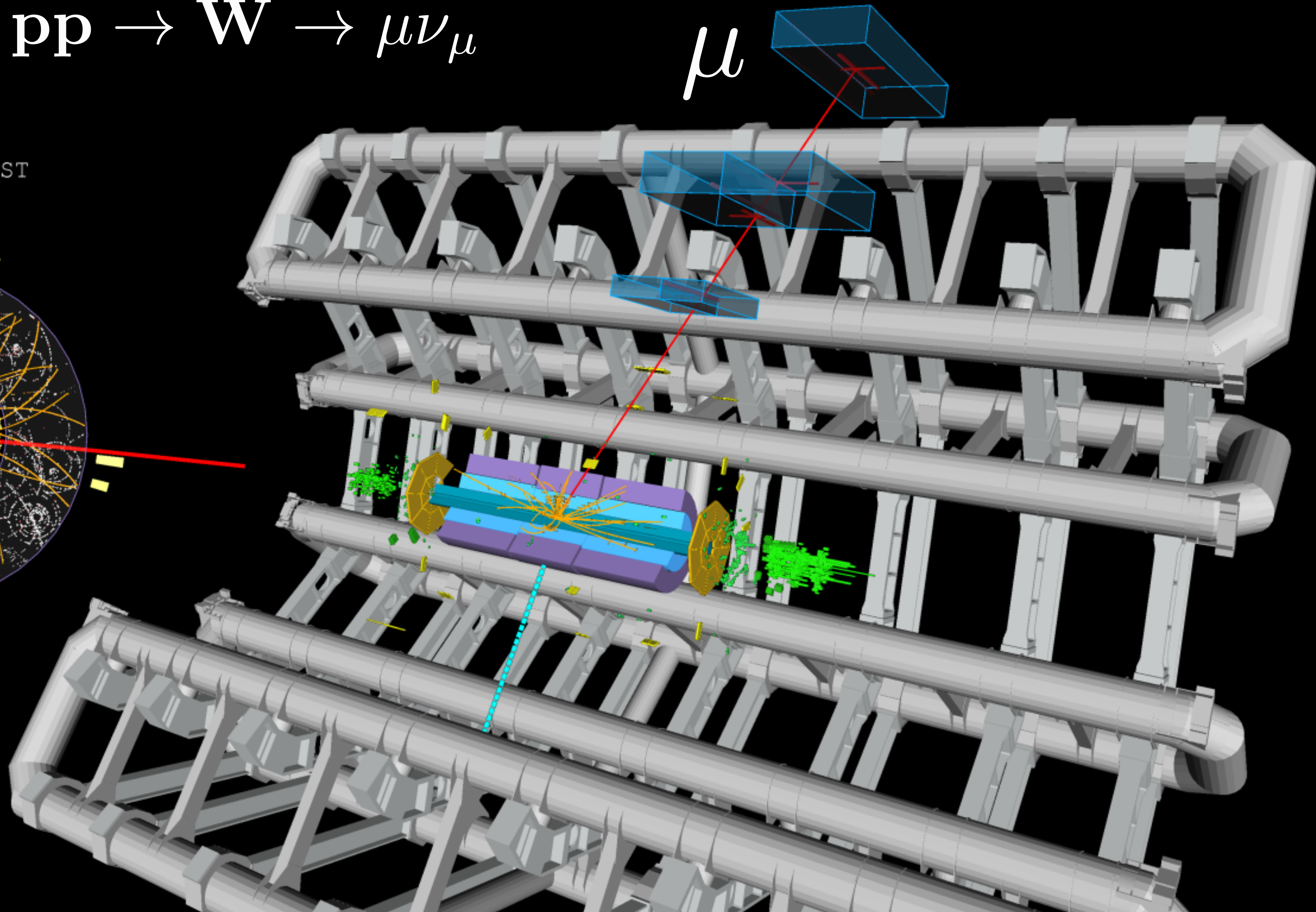
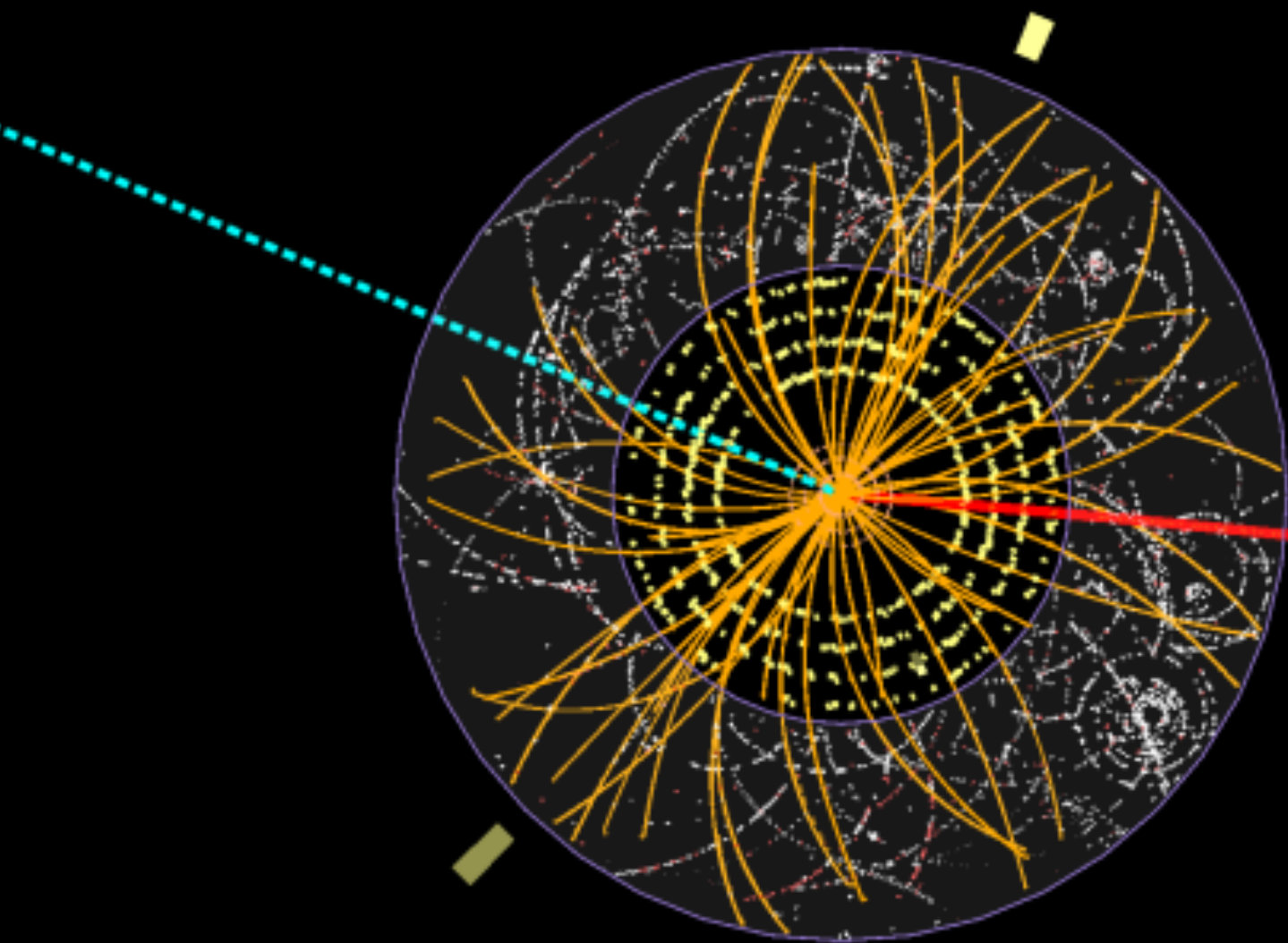



# Inclusive Precision Vector Boson Production at the LHC

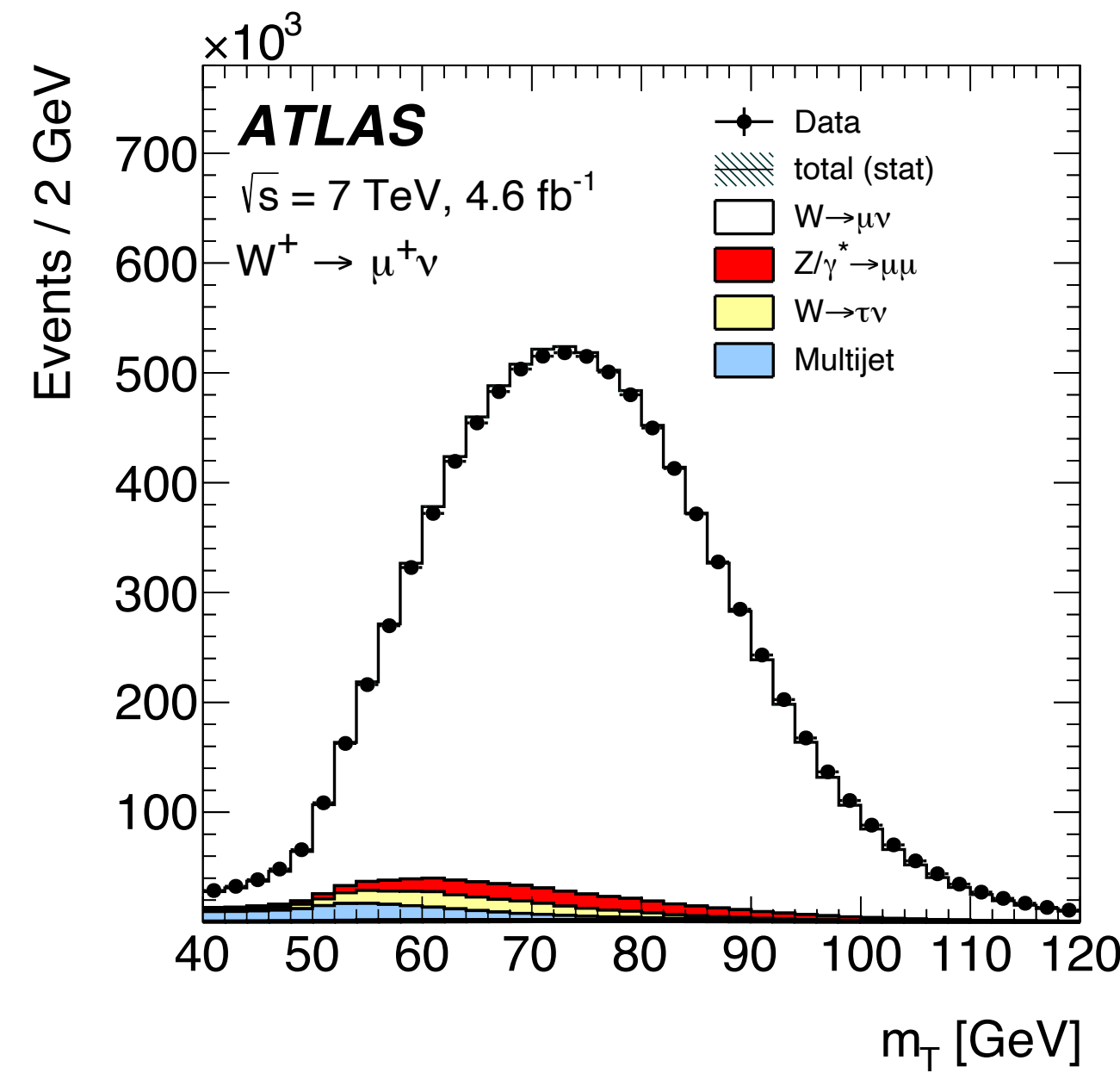
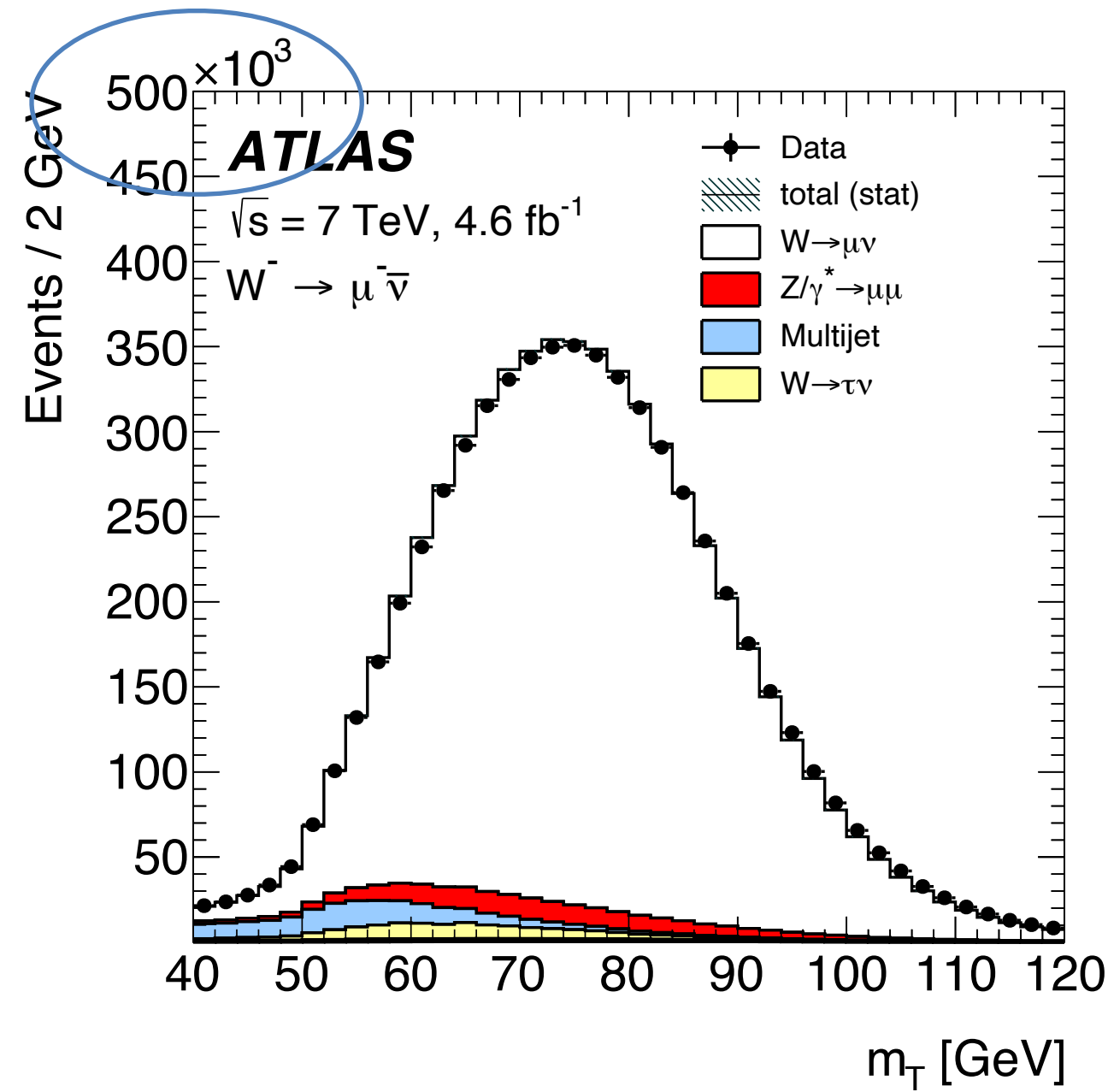

With a dataset of only 4.6 fb<sup>-1</sup> at **7 TeV**, approximately 15.5 M W<sup>+</sup> events and 10.4 W<sup>-</sup> events (electrons and muons). **Low PU!**

Cross section measurement uncertainty **completely dominated by luminosity uncertainty of 1.8%**

Differential cross sections for both W, Z, and Z with one forward electron are derived as a function of lepton pseudo-rapidity (W) and the Z rapidity.

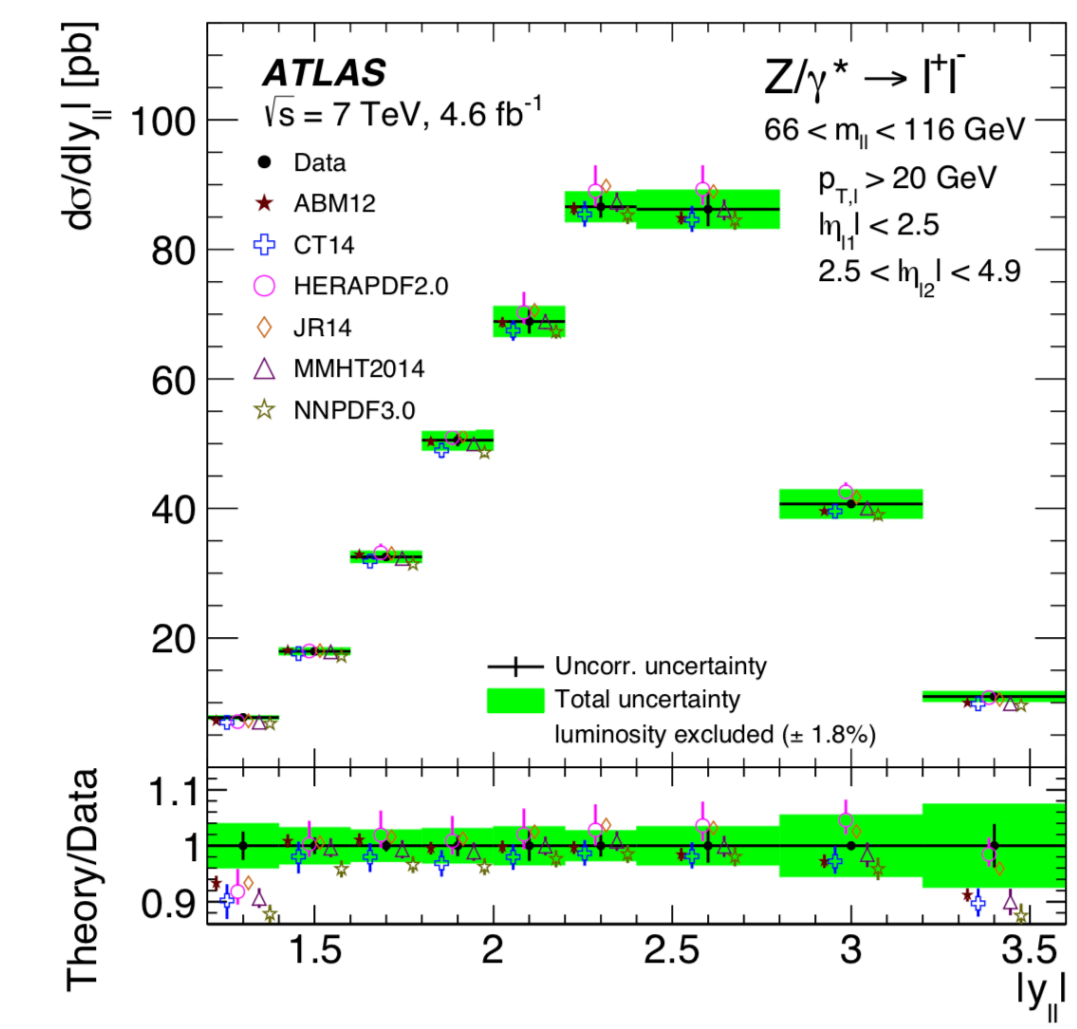
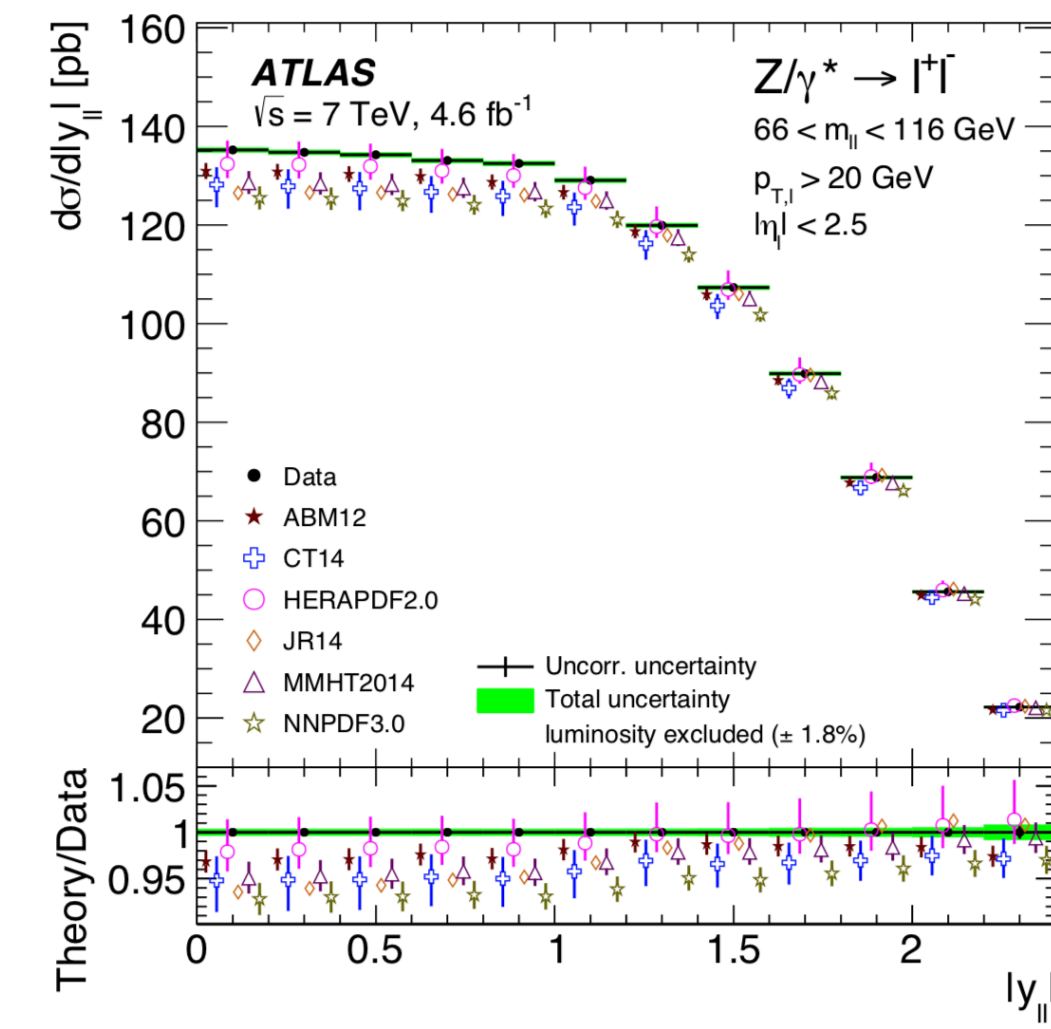
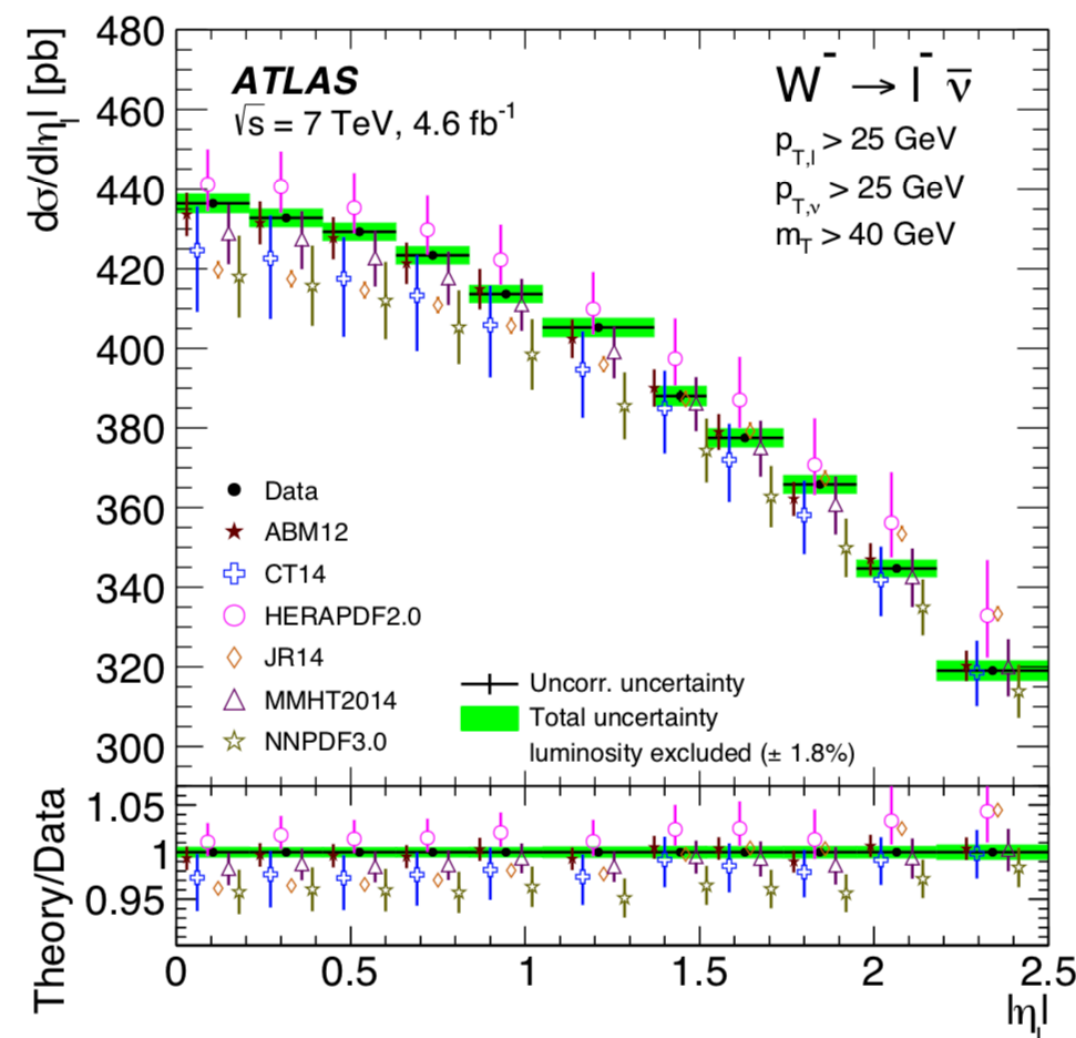
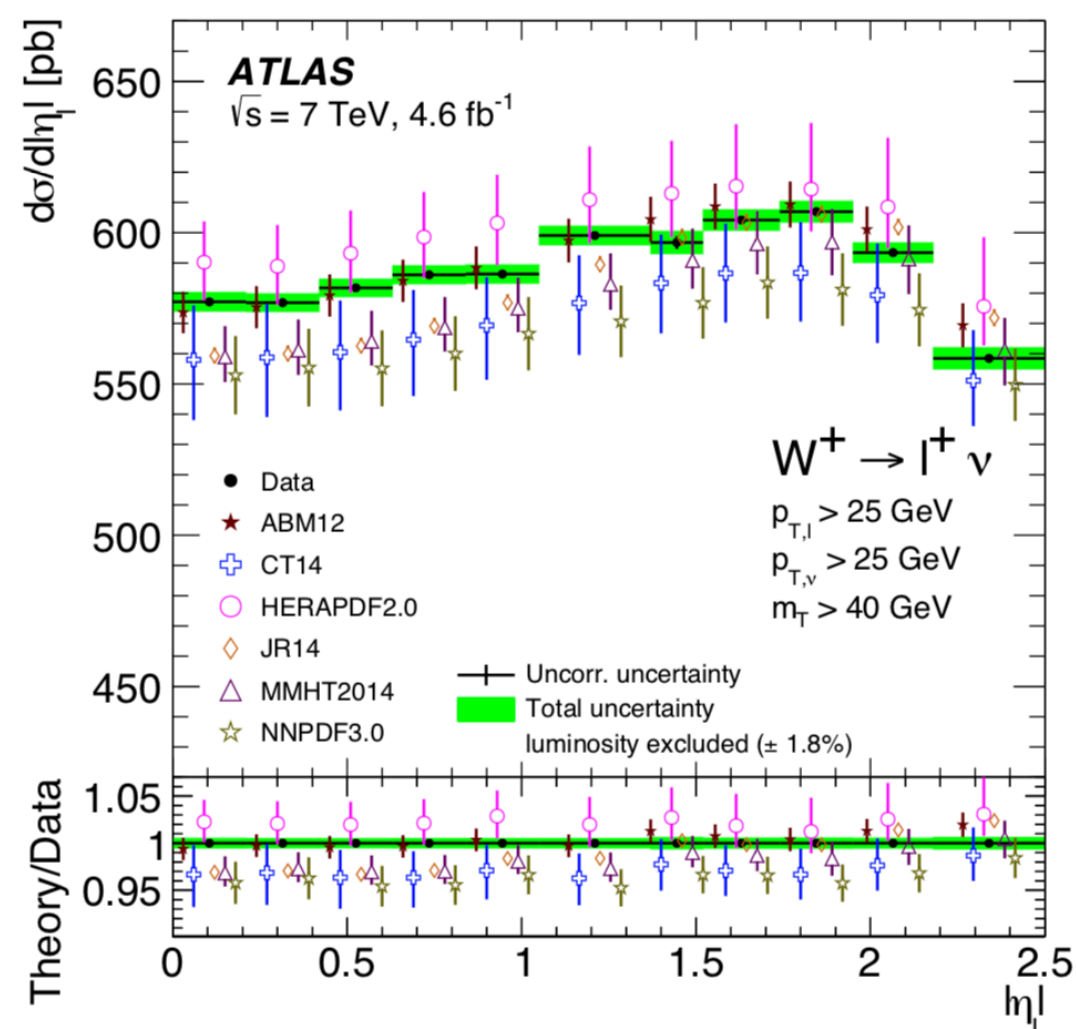

# Inclusive Precision Vector Boson Production at the LHC

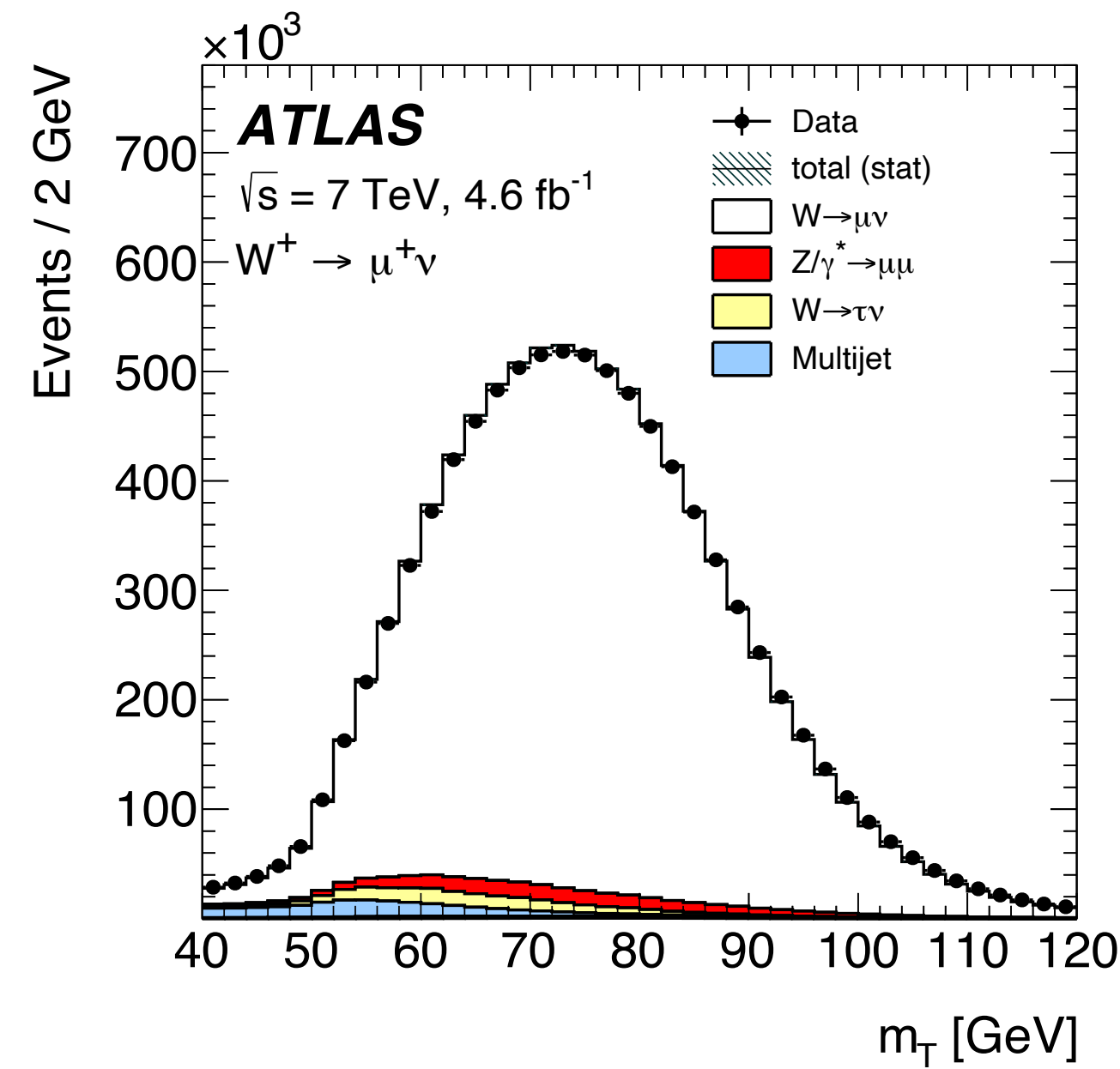
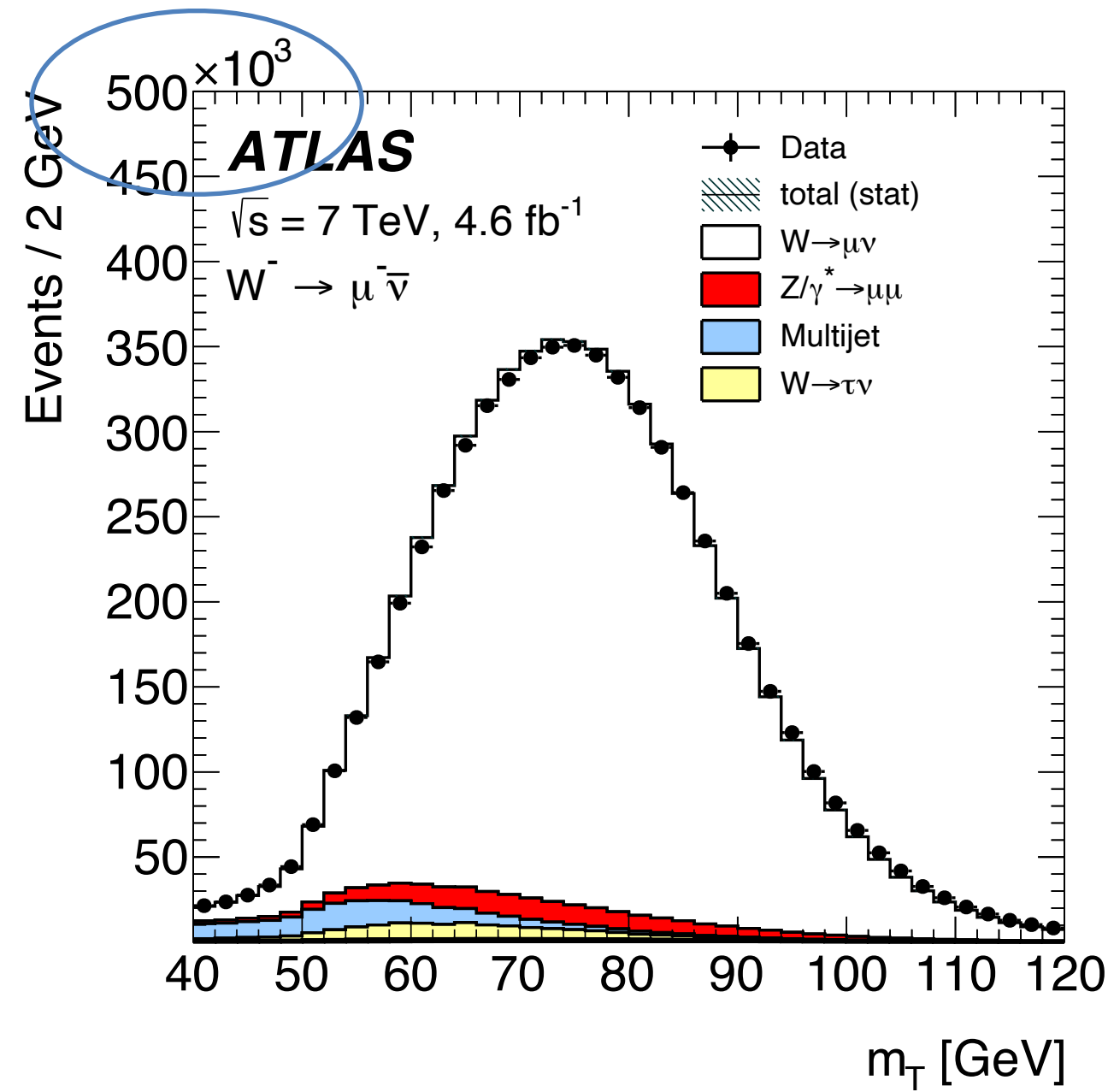

With a dataset of only 4.6 fb<sup>-1</sup> at 7 TeV, approximately 15.5 M W<sup>+</sup> events and 10.4 W<sup>-</sup> events (electrons and muons). **Low PU !**

Cross section measurement uncertainty **completely dominated by luminosity uncertainty of 1.8%**

Differential cross sections for both W, Z, and Z with one forward electron are derived as a function of lepton pseudo-rapidity (W) and the Z rapidity.

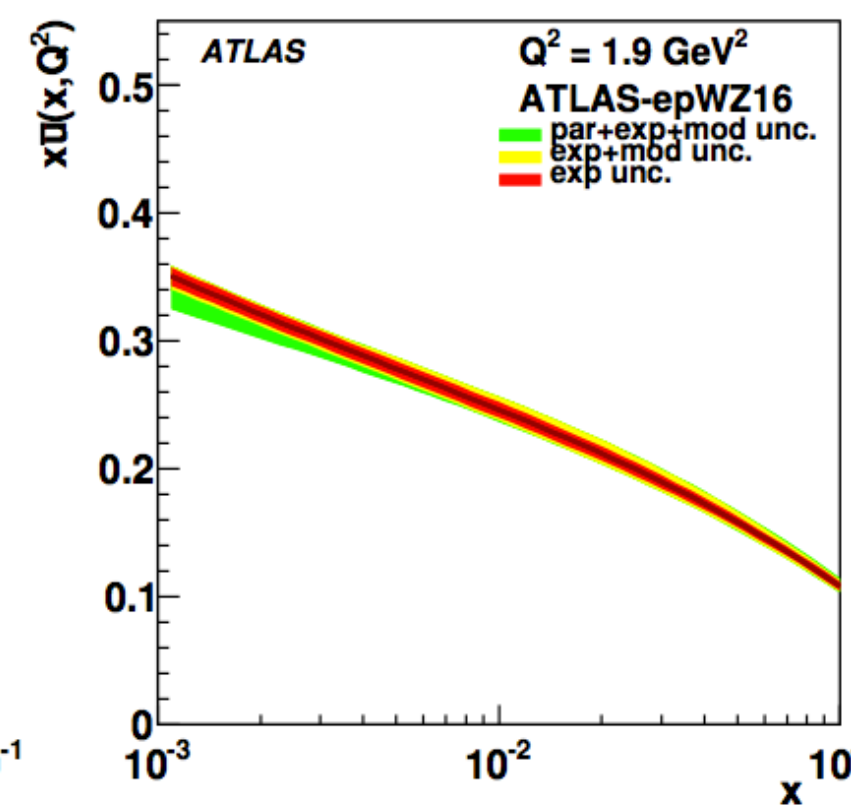
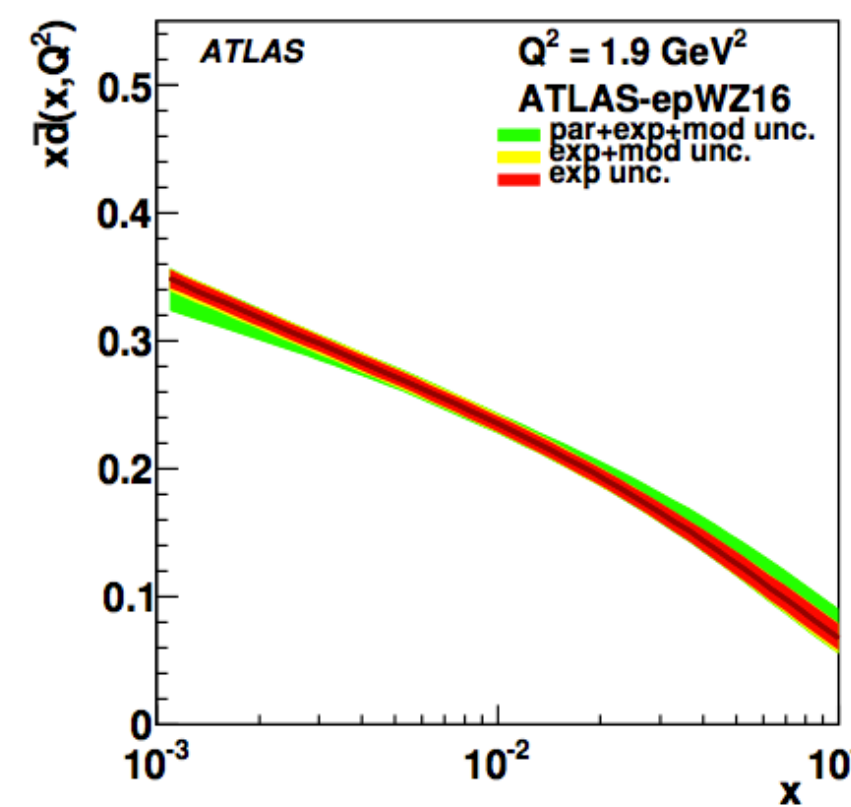
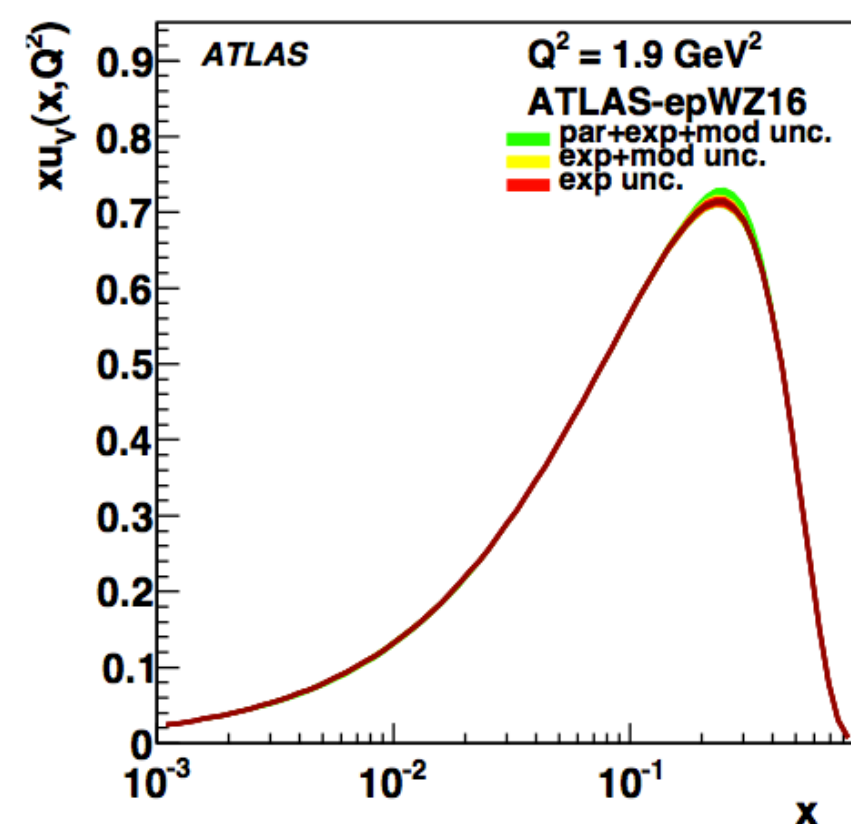
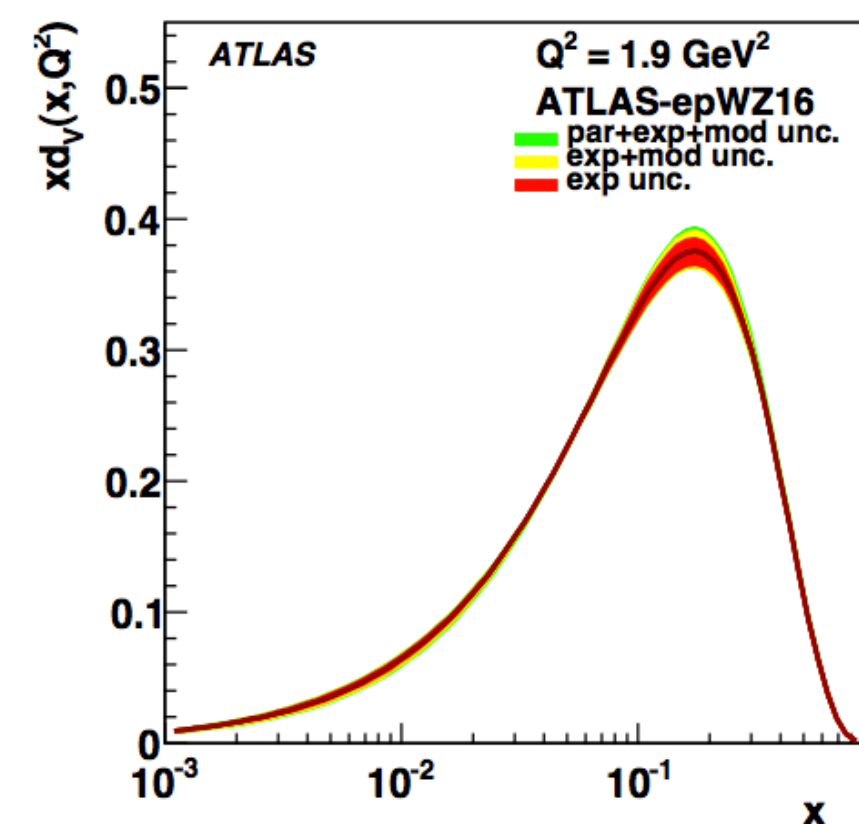

Using these cross section measurements and the the Deep Inelastic Scattering data from Hera new set of PDFs can be estimated (ATLAS-epWZ16 same was done in CMS).

# Measurement of the W Mass at the LHC

## A Milestone measurement!

Analysis strategy based on two kinematic distributions fitted in several categories

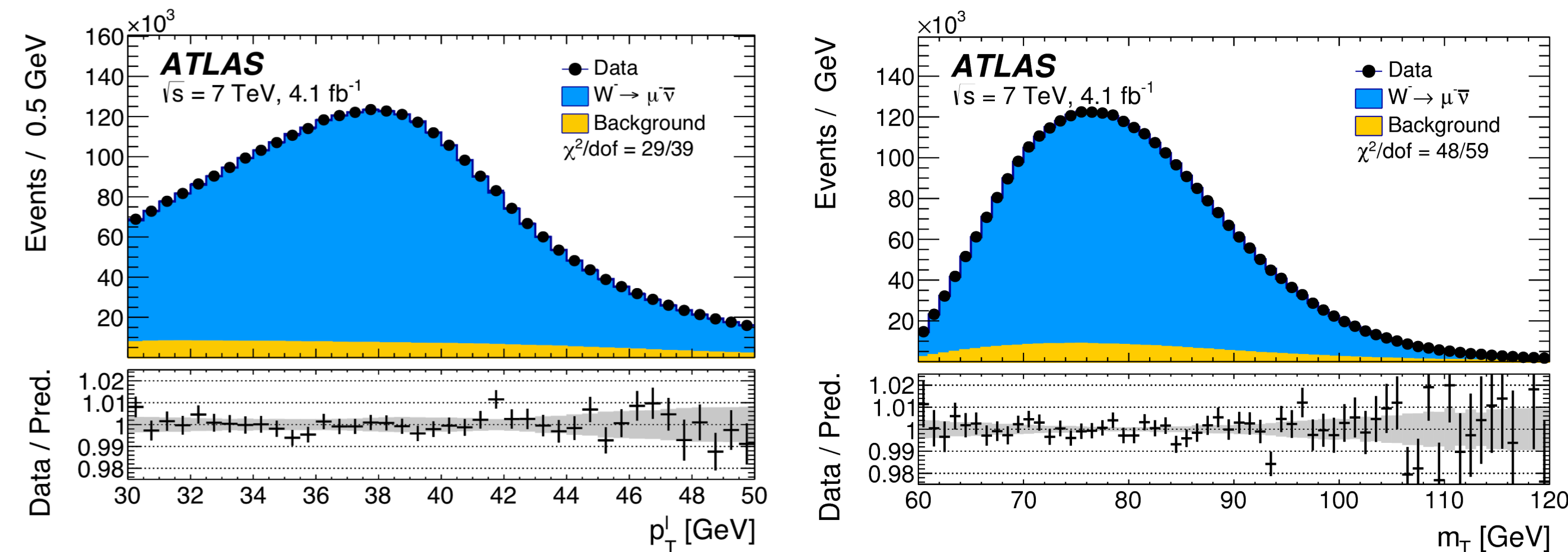

$$p_T^\ell$$

Clean energy measurement, but more sensitive to the modelling of the W transverse momentum

$$m_T$$

Less sensitive to modelling but more difficult from to reconstruct (based on the missing transverse energy).

$$m_T = \sqrt{2p_T^\ell p_T^{\text{miss}} (1 - \cos\Delta\phi)}$$

Categories are defined by the charge of the reconstructed lepton, its flavor (electron or muon) and its pseudo rapidity.

$$m_W = 80369.5 \pm 18.5 \text{ MeV}$$

$$\pm 6.8 \text{ (Stat)} \pm 10.6 \text{ (Exp)} \pm 13.6 \text{ (Mod)} \text{ MeV}$$

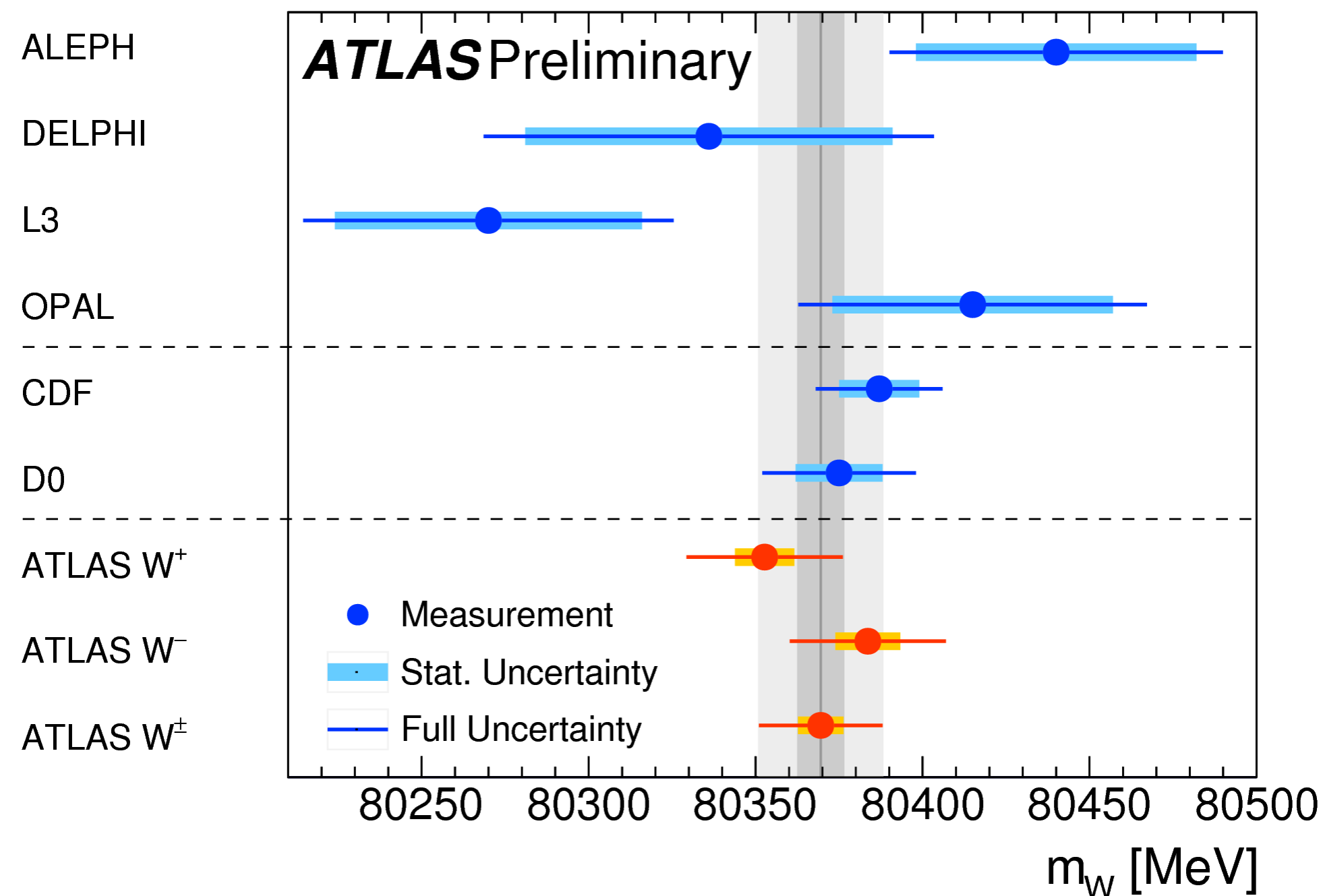

## EW Mixing angle

With the increased luminosity and muon acceptance in CMS (from eta 2.4 to 2.8 - for this study)

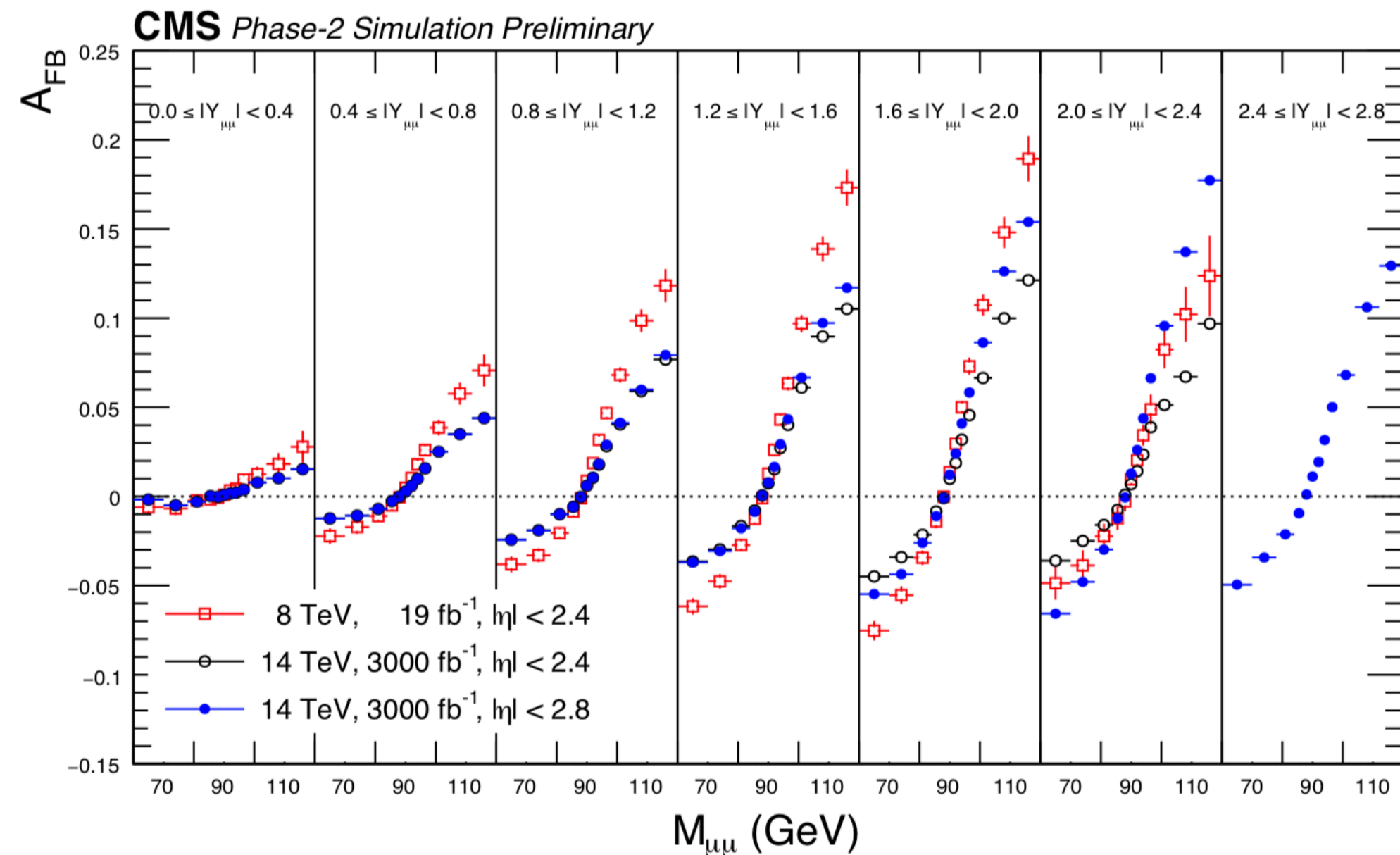

Individual measurements reach the level of the current World Average of **16 (10<sup>-5</sup>)** CMS estimate alone with muons.

## W Mass

- Need for low PU (~2)
- Need from ~200 pb<sup>-1</sup> (already a good start only approximately one week at 14 TeV) to 1 fb<sup>-1</sup>
- Larger TRK acceptance: reduce PDF systematics

**CDF W mass measurement discussed tomorrow!**

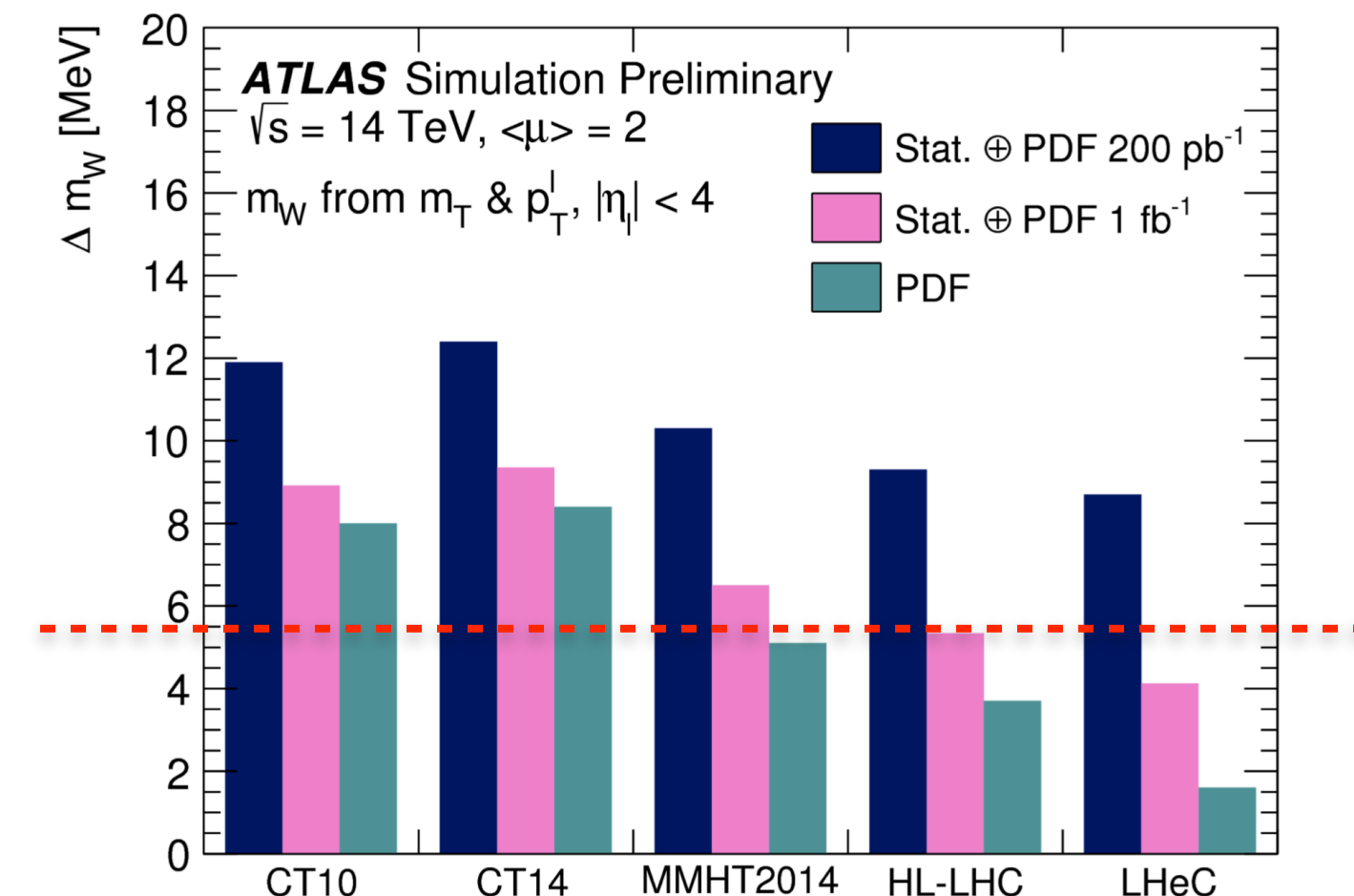

Precision reach at HL-LHC

~10 MeV for 200 pb<sup>-1</sup>  
 ~6 MeV for 1 fb<sup>-1</sup>  
 (~4 MeV with LHeC)

# Top quark Physics

# Top Quark

The existence of the top quark was first predicted to explain CP violation in Kaons by Kobayashi and Maskawa in 1973



2008

Discovery of the Origin of the CP violation and the need for three families of fermions

Makoto Kobayashi, Toshihide Maskawa



1999

Elucidating the quantum structure of EW interaction

Gerardus 't Hooft, Martinus Veltman

« The mass of the top quark could be predicted (with quantum corrections in the electroweak theory) from the precision LEP measurements » [\[Reference\]](#)

The top quark was discovered in 1994 at the Tevatron by the CDF and D0 Experiments.

The top quark decays mostly into a W boson and a b quark, and at the Tevatron is produced mainly in pairs.

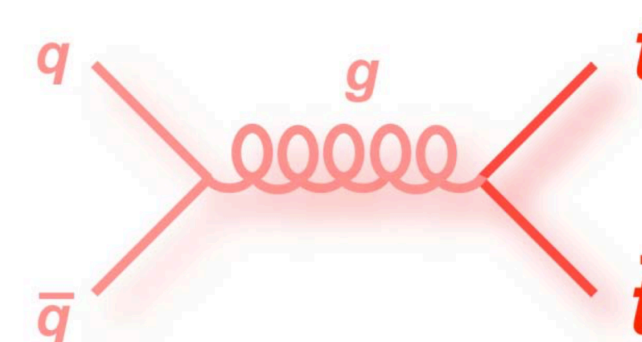
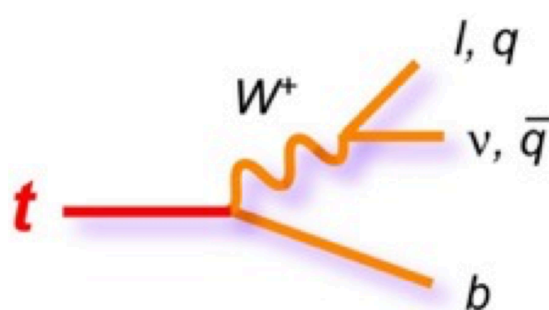

Gives rise to multitude of signatures (the most sensitive being the leptons-4jets)

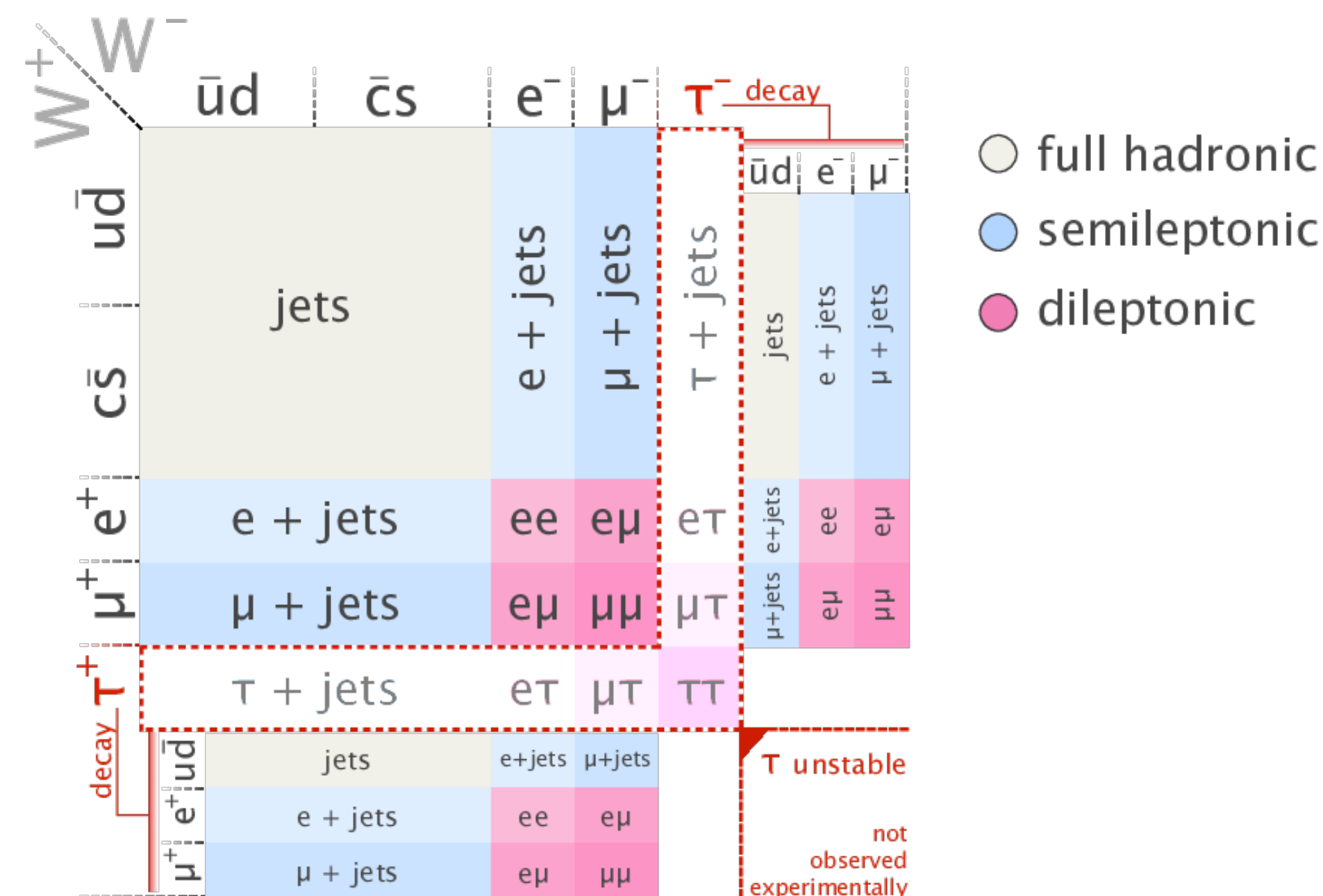

$$Br(W \rightarrow \ell\nu) = 10.9\%$$

$$Br(W \rightarrow u\bar{d}, c\bar{s}) = 67.4\%$$

# Top Quark

The existence of the top quark was first predicted to explain CP violation in Kaons by Kobayashi and Maskawa in 1973



2008

Discovery of the Origin of the CP violation and the need for three families of fermions  
Makoto Kobayashi, Toshihide Maskawa



1999

Elucidating the quantum structure of EW interaction  
Gerardus 't Hooft, Martinus Veltman

« The mass of the top quark could be predicted (with quantum corrections in the electroweak theory) from the precision LEP measurements » [\[Reference\]](#)

The top quark was discovered in 1994 at the Tevatron by the CDF and D0 Experiments.

The top quark decays mostly into a W boson and a b quark, and at the Tevatron is produced mainly in pairs.

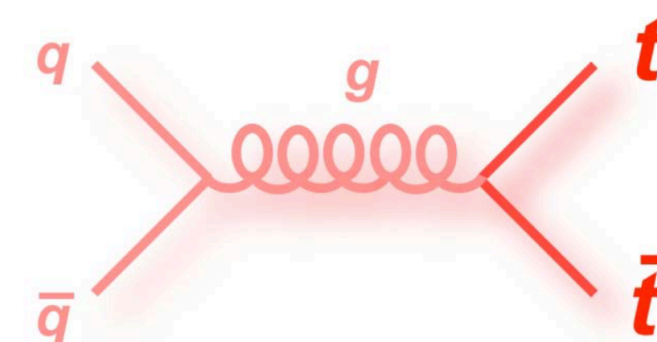
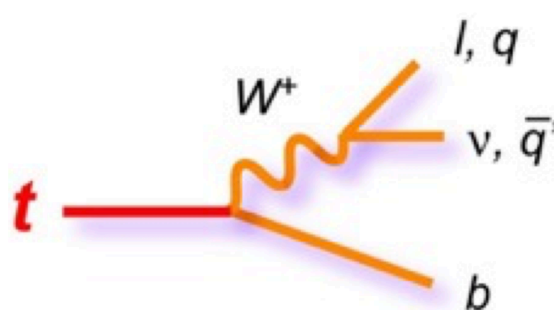

Gives rise to multitude of signatures (the most sensitive being the leptons-4jets)

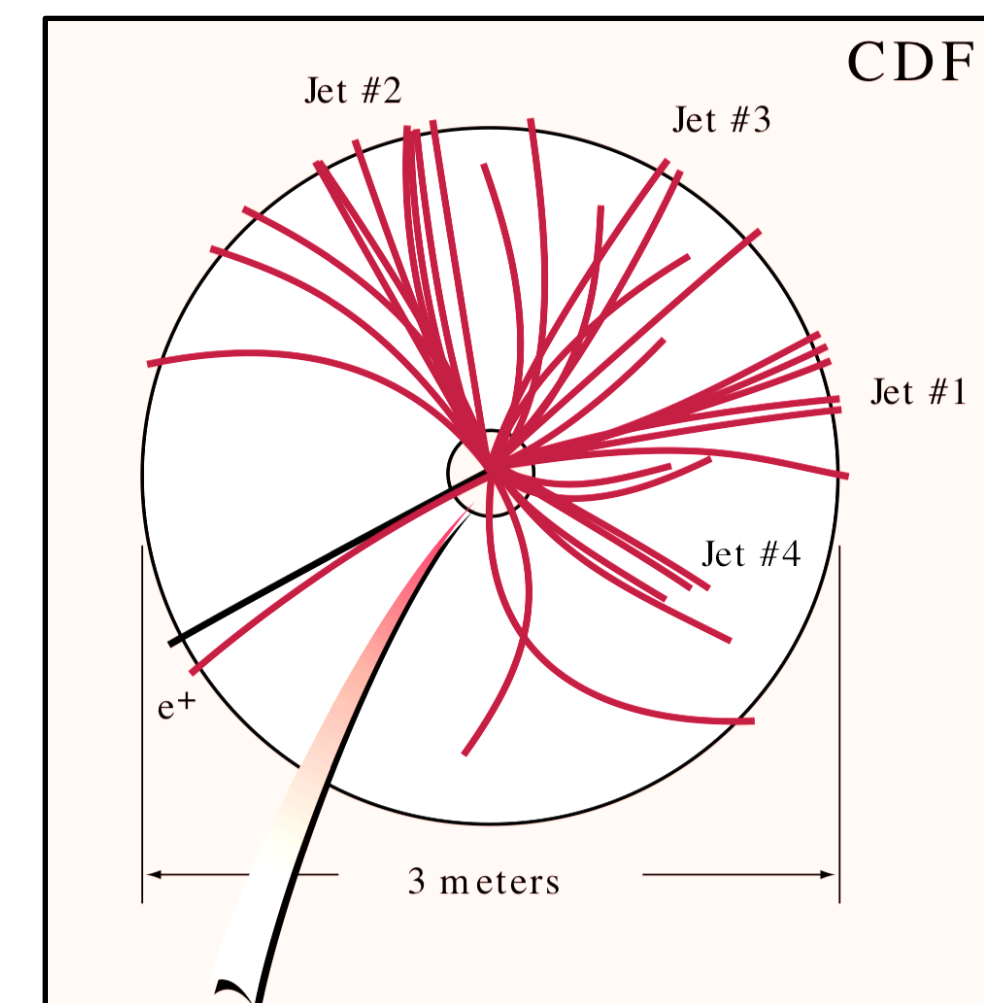
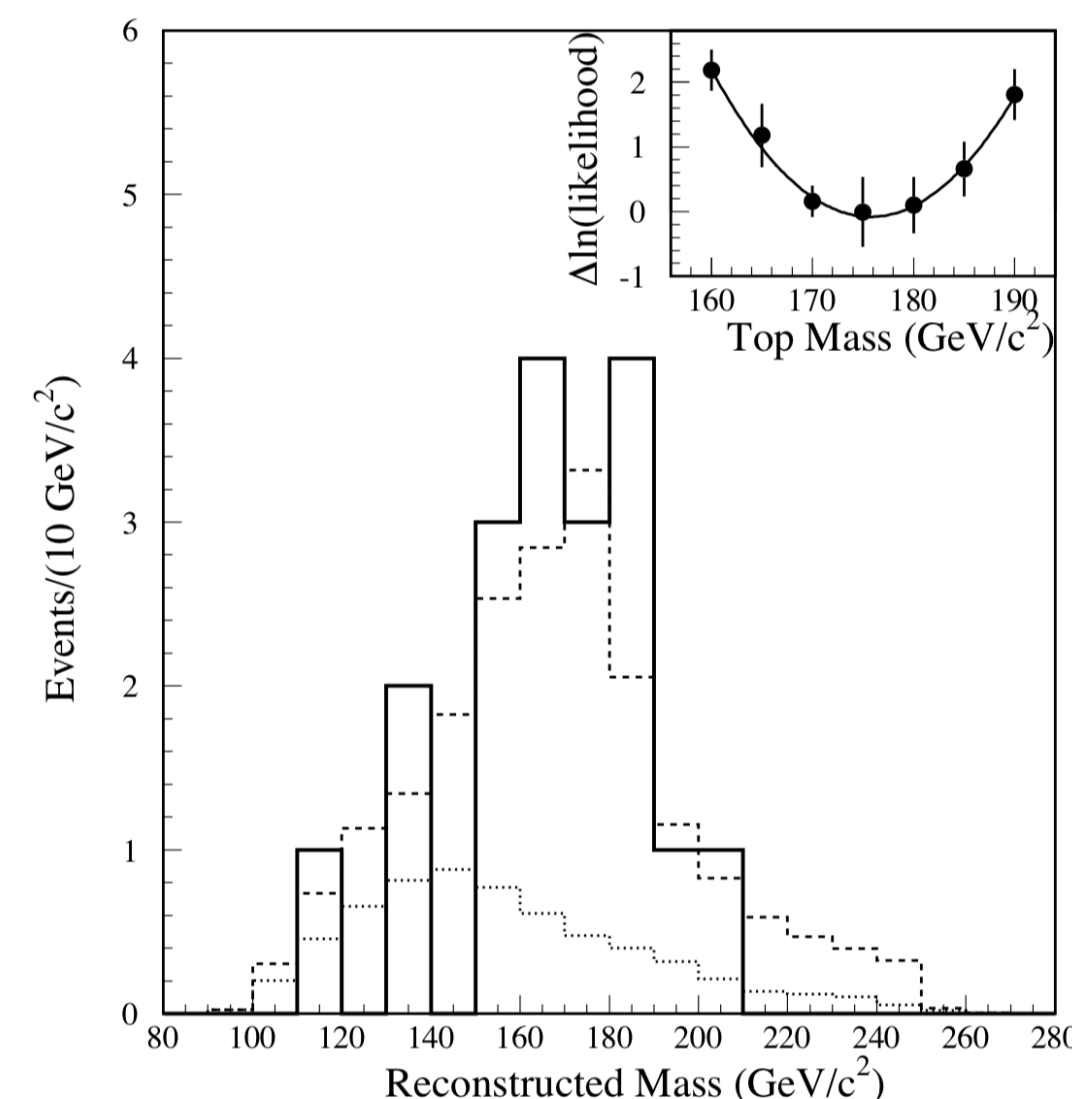

Observation in the 1 lepton - 4 jets topology, yielding a mass measurement of approximately 175 GeV

$$y_t = \frac{\sqrt{2}m_t}{v} \sim 1 \quad v = 246 \text{ (GeV)}$$

The top quark is the only quark observed directly as a physical state, since it decays before it hadronises!

# Top pair production Cross Sections at the LHC

## Main production diagrams

At tree level leading order

$$O(\alpha_S^2)$$

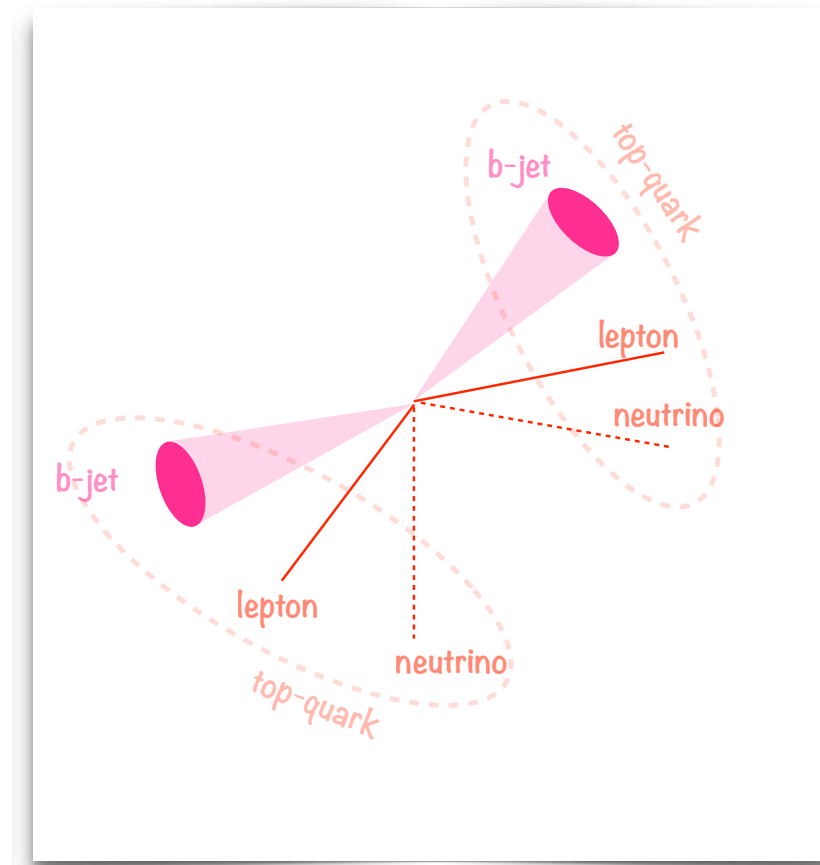
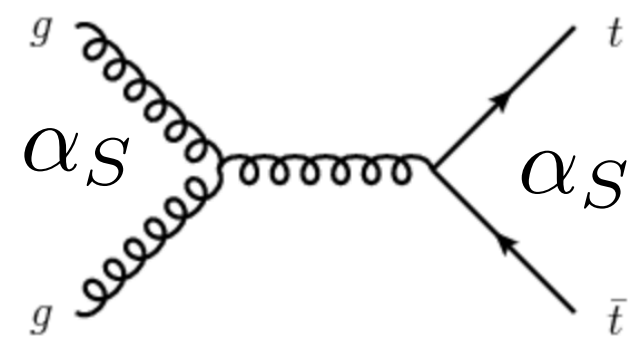
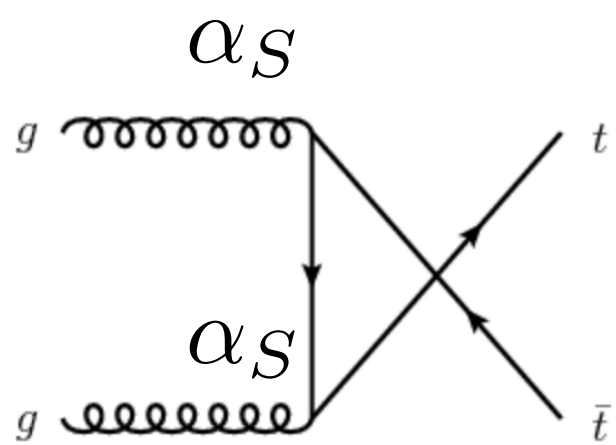
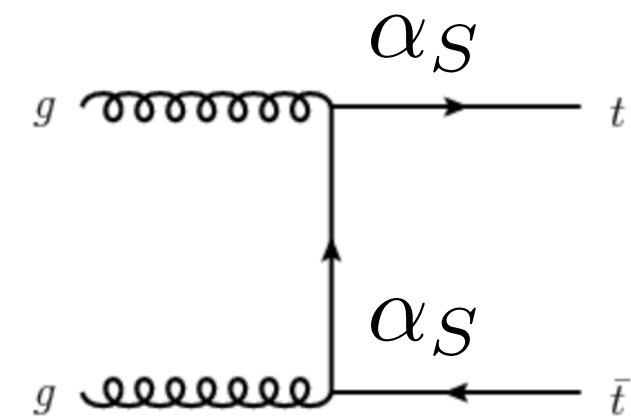

## Di-lepton topology:

Precise determination of cross section in the different flavour electron-muon channel in particular. Excellent signal to background ratio. Lower stats (4%).

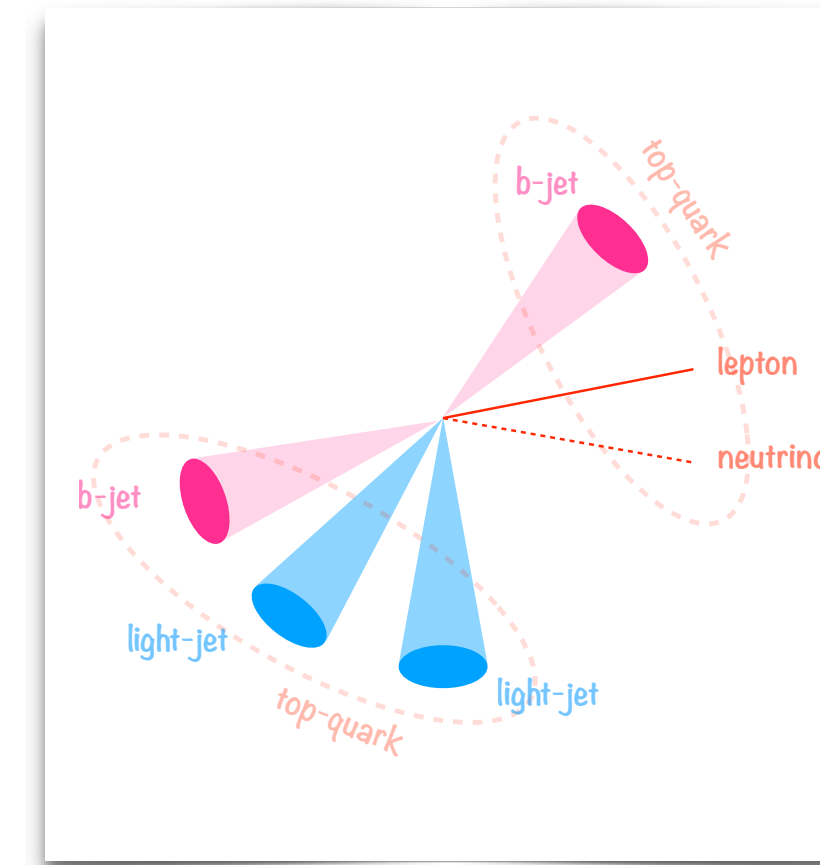

## Semi-leptonic topology:

Best compromise between statistics (30%) and signal to background ratio.

Inclusive  $t\bar{t}$  cross section [pb]

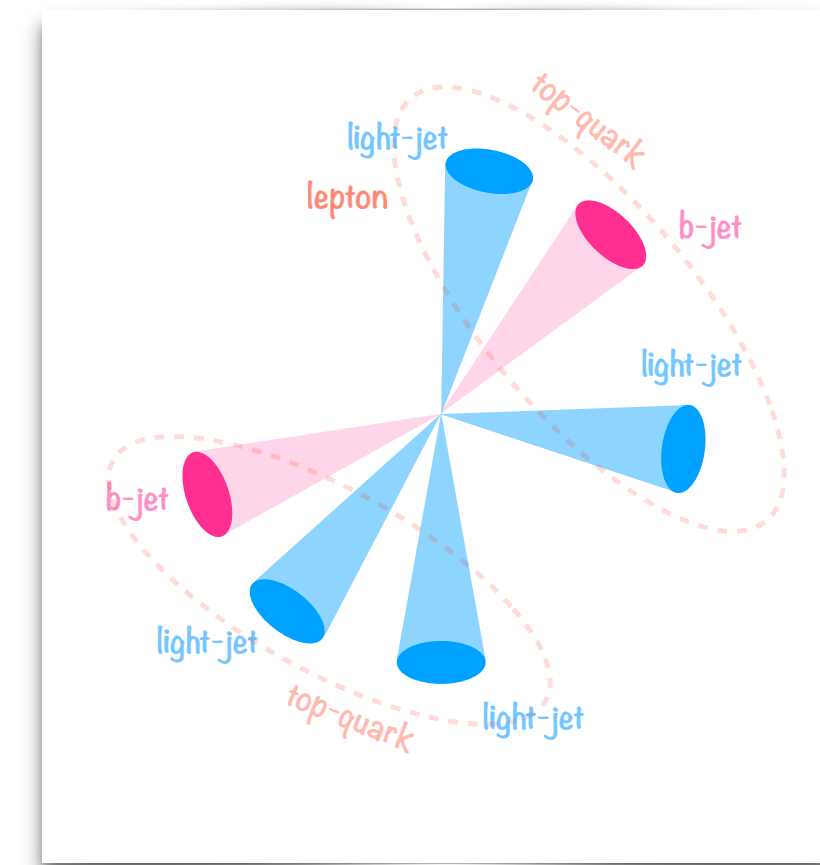
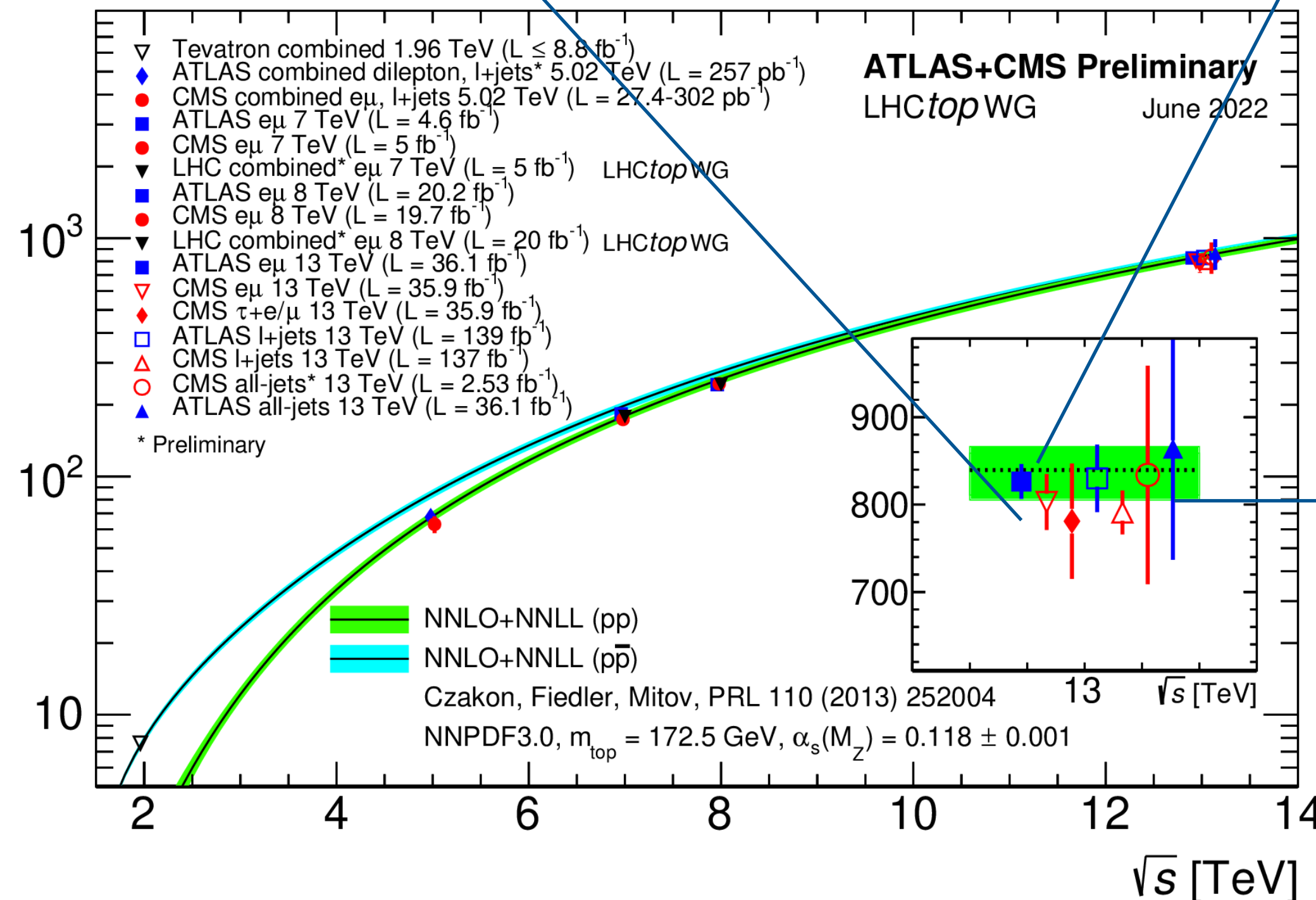

## Full hadronic topology:

Largest stats (50%) but larger multi-jet background and large combinatorial.



# Single-top production Cross Sections

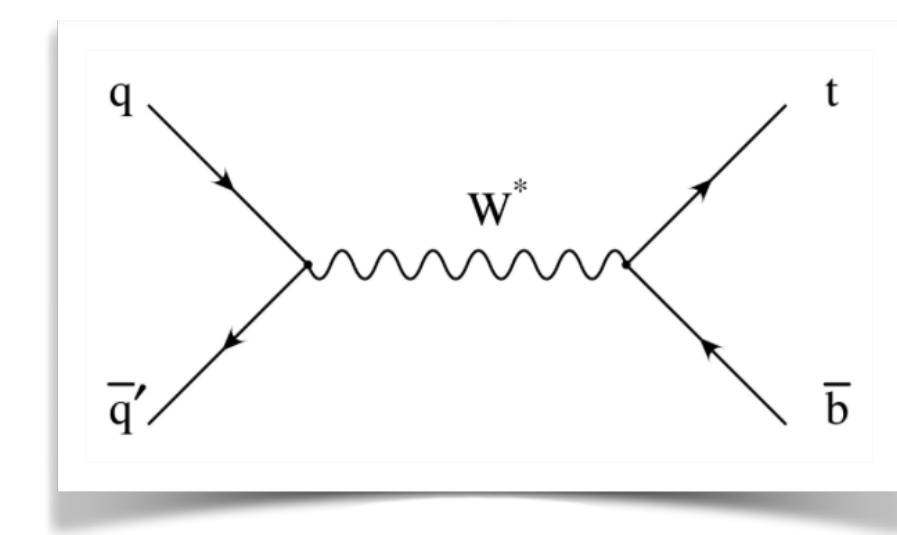
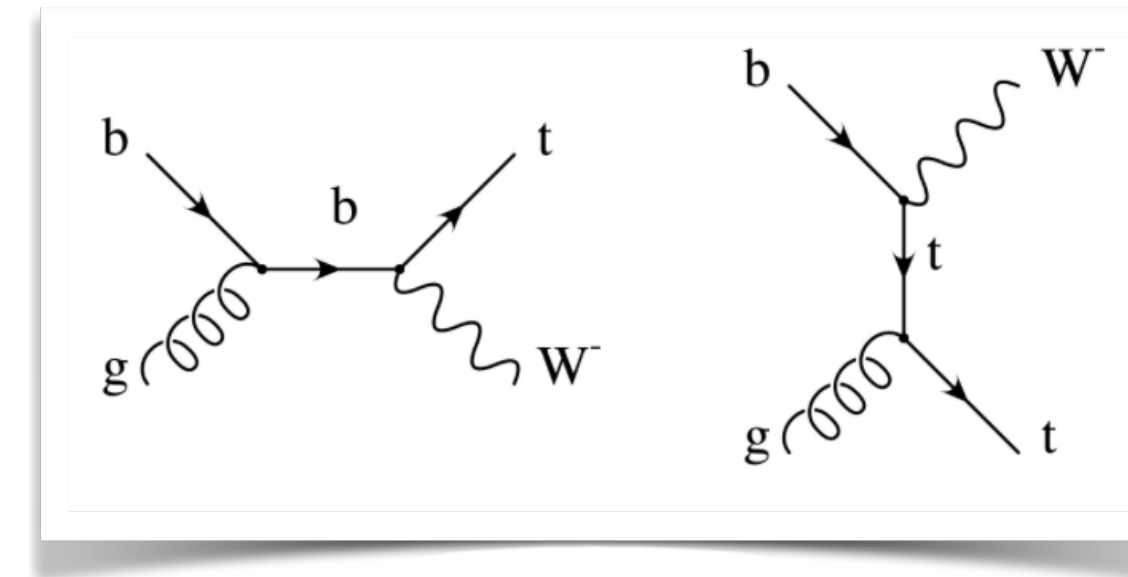
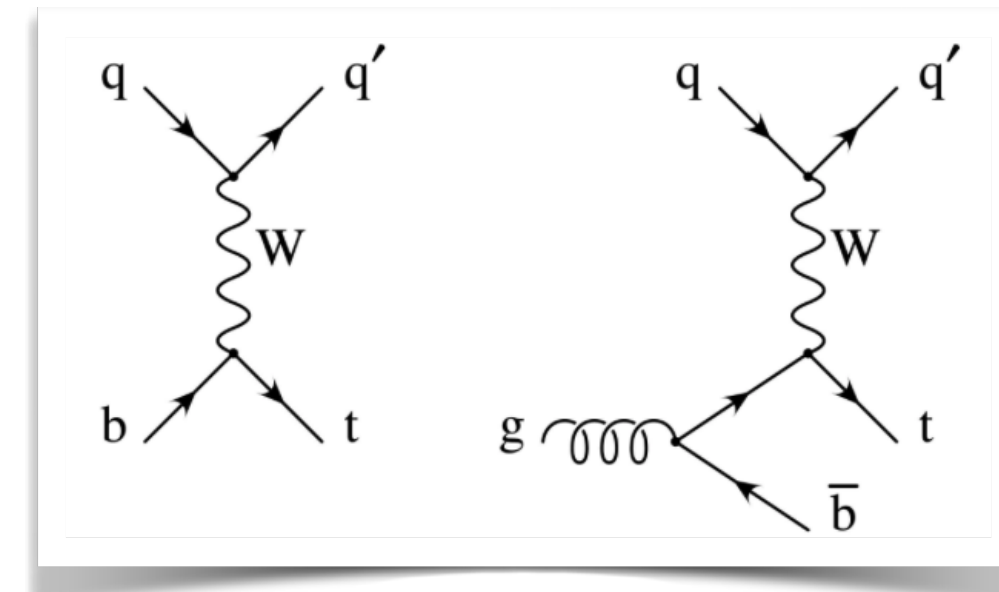
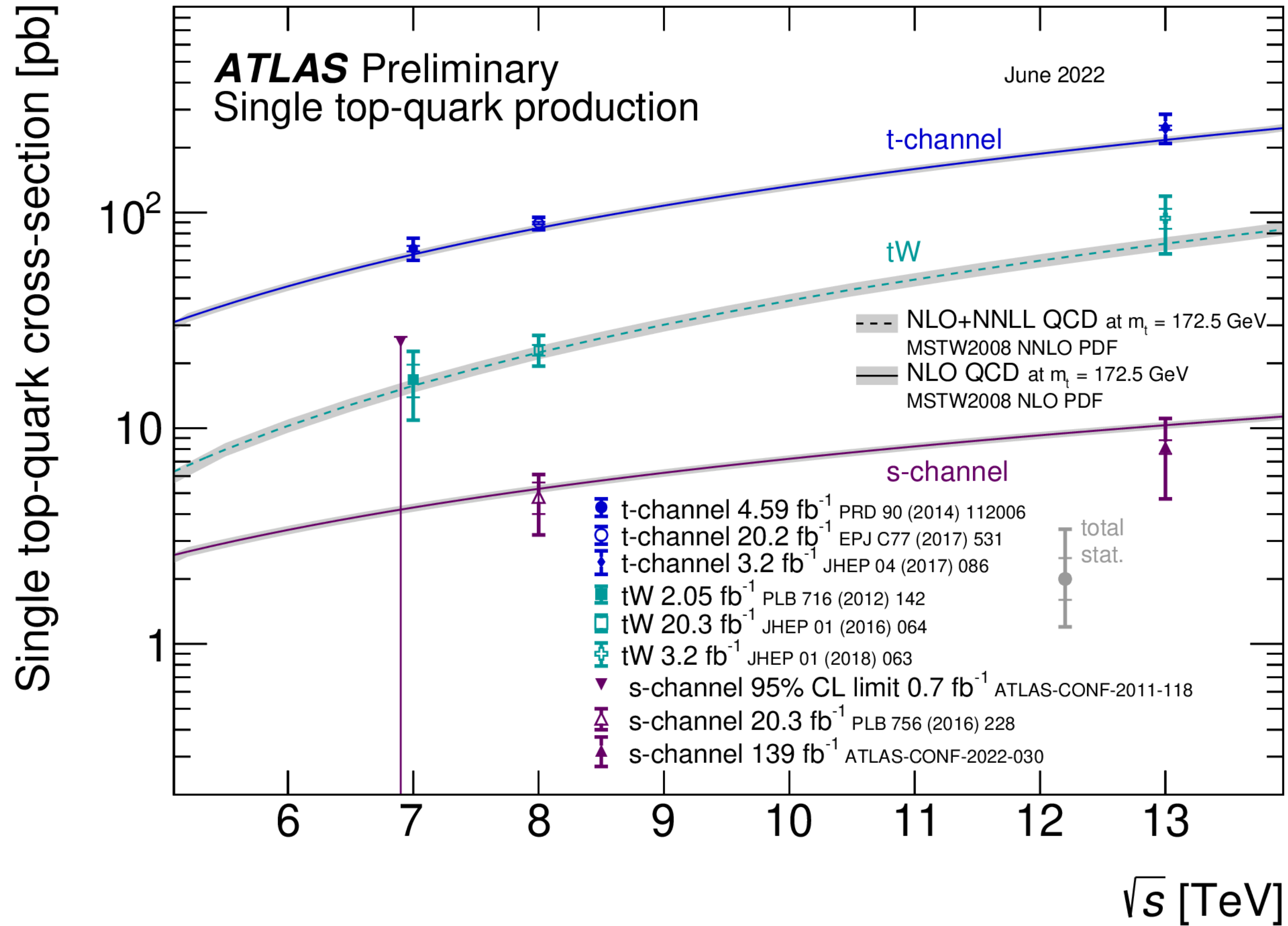

# Measuring the top mass from event kinematics

Direct measurements made using template fit to the reconstructed mass spectrum.

## Most precise individual top mass from CMS

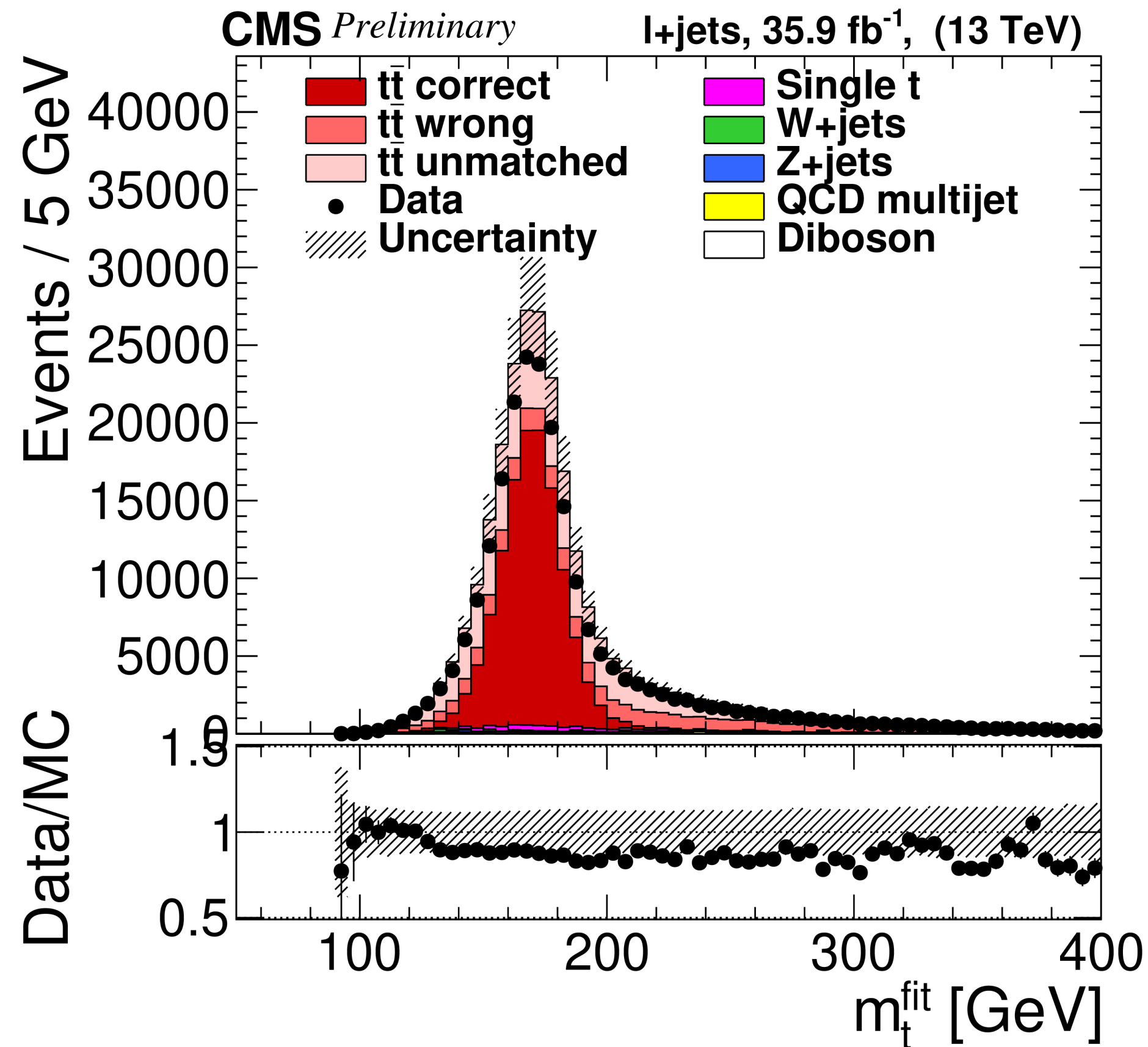

$171.77 \pm 0.04 \text{ (stat)} \pm 0.38 \text{ (syst)} \text{ GeV}$

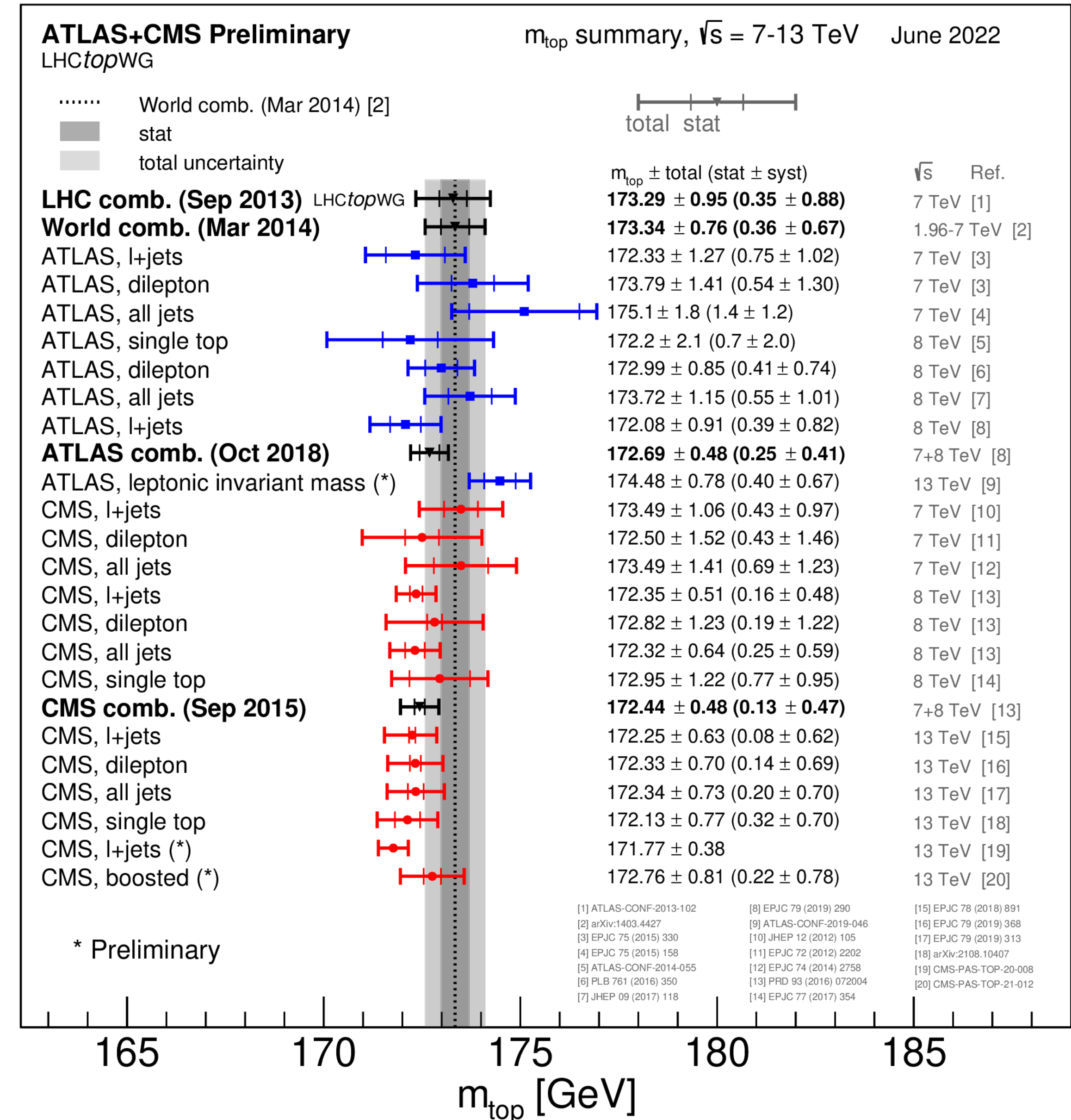

# Measuring the top mass from event kinematics

Direct measurements made using template fit to the reconstructed mass spectrum.

## Most precise individual top mass from CMS

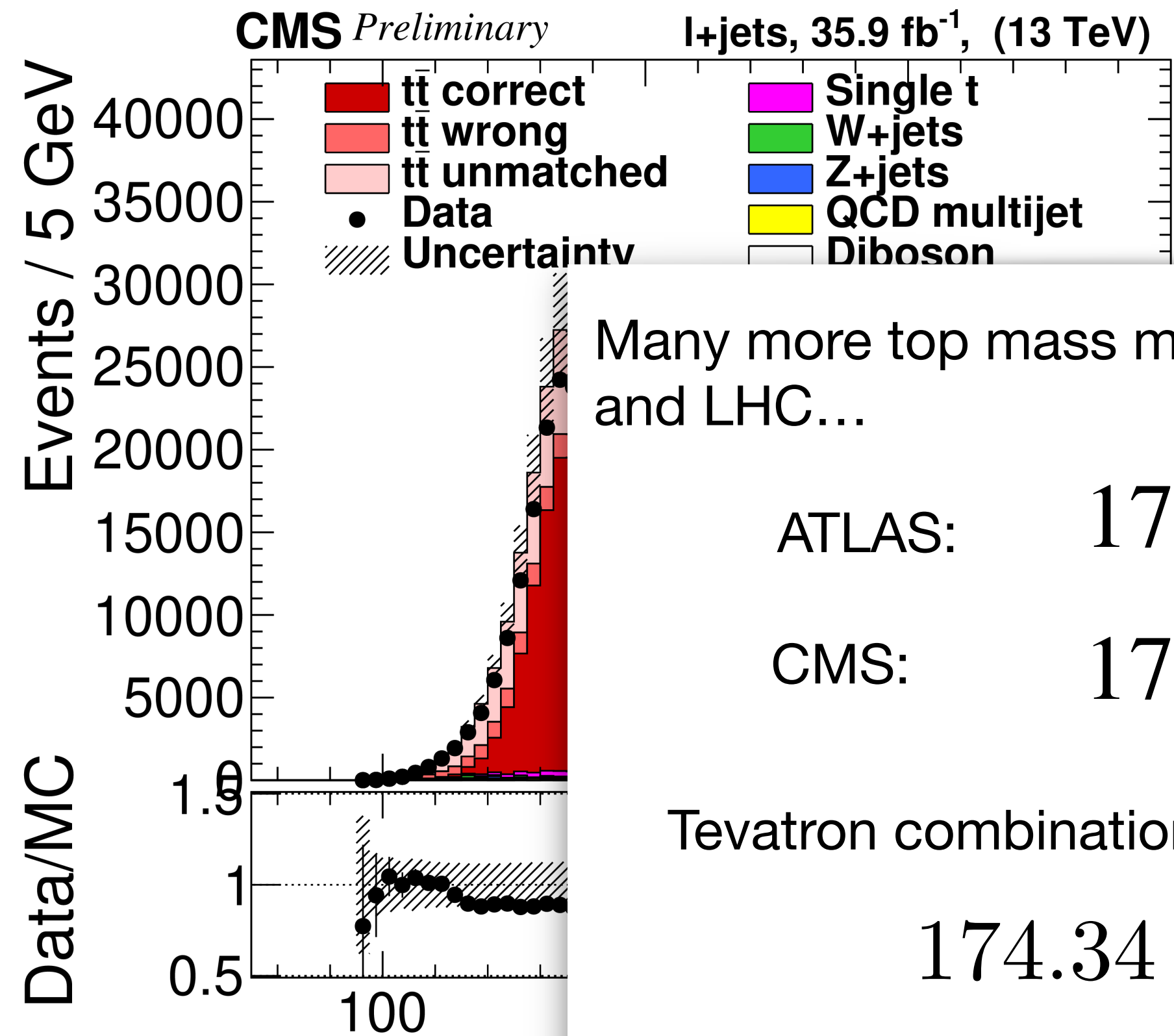

Many more top mass measurements, still slight tension between Tevatron and LHC...

ATLAS:  $172.69 \pm 0.25$  (stat)  $\pm 0.41$  (syst)

CMS:  $172.44 \pm 0.13$  (stat)  $\pm 0.47$  (syst)

Tevatron combination:

$174.34 \pm 0.37$  (stat)  $\pm 0.52$  (syst)

$171.77 \pm 0.04$  (stat)  $\pm 0.38$  (syst) GeV

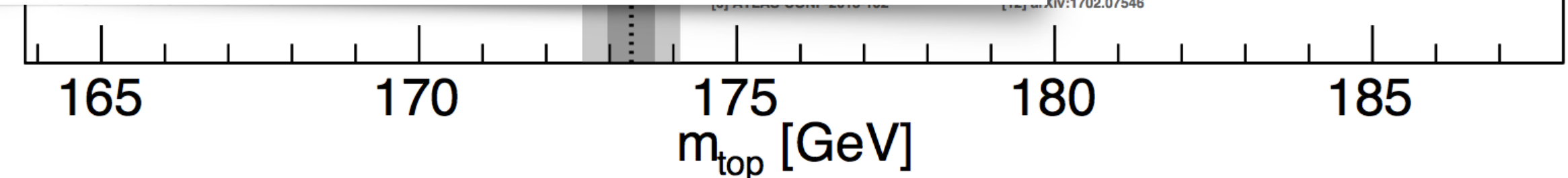
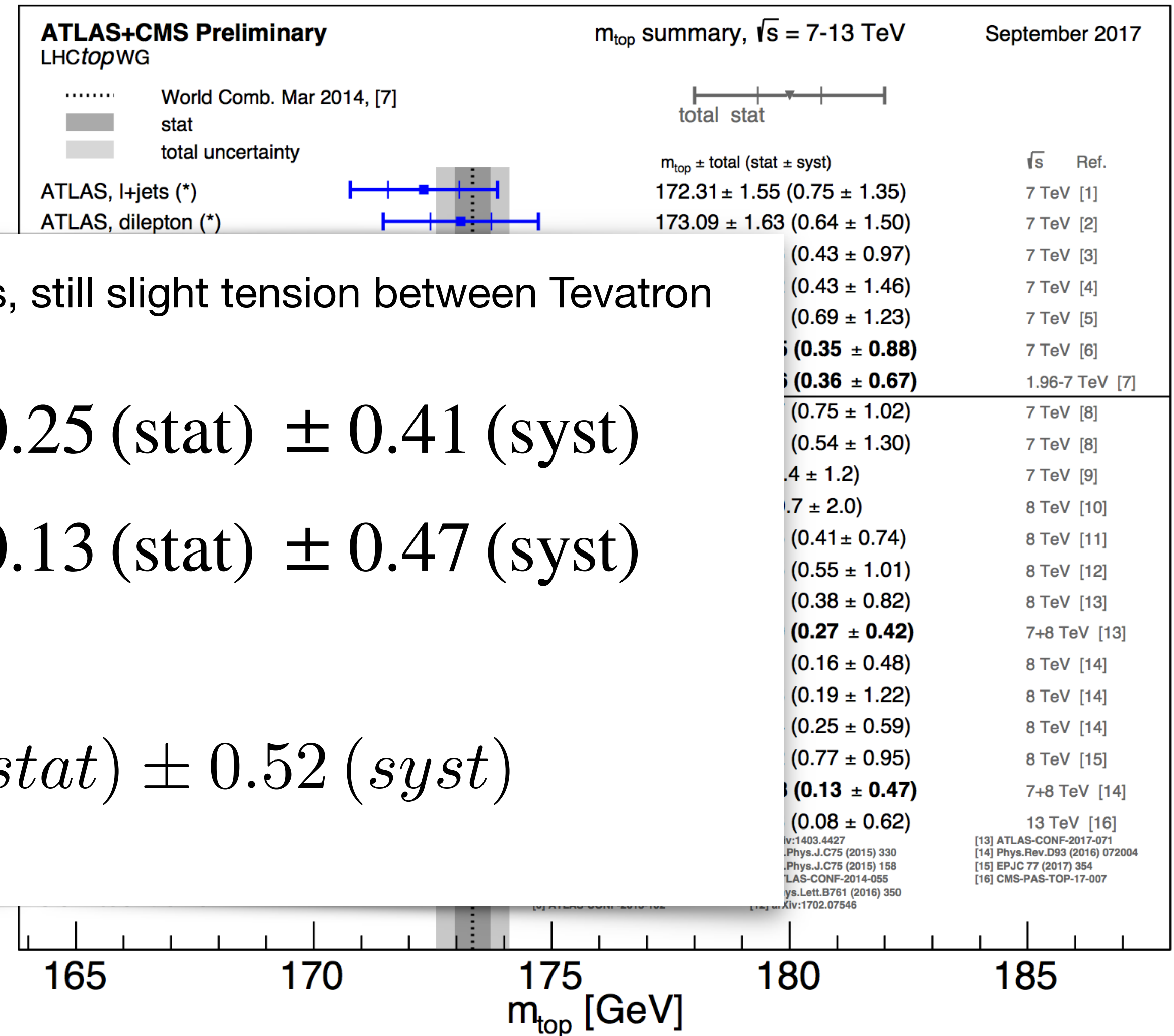

# Digression on the Mass Measurement

The relation between the Monte Carlo template used to fit the mass spectrum and the Field Theoretical parameter of the pole mass is not straightforward.

The top is coloured, so it is impossible to unambiguously associate every object in the final state to it!

These ambiguities lead to an uncertainty on the top mass measurement varying between 1 GeV and 200 MeV.

The pole mass can be measured using observables that are not dependent on the detailed reconstruction of the top system.

*e.g. the pole mass can be measured using the top production cross section (at the cost of introducing a dependence on the production prediction).*

Colour connection through hadronisation

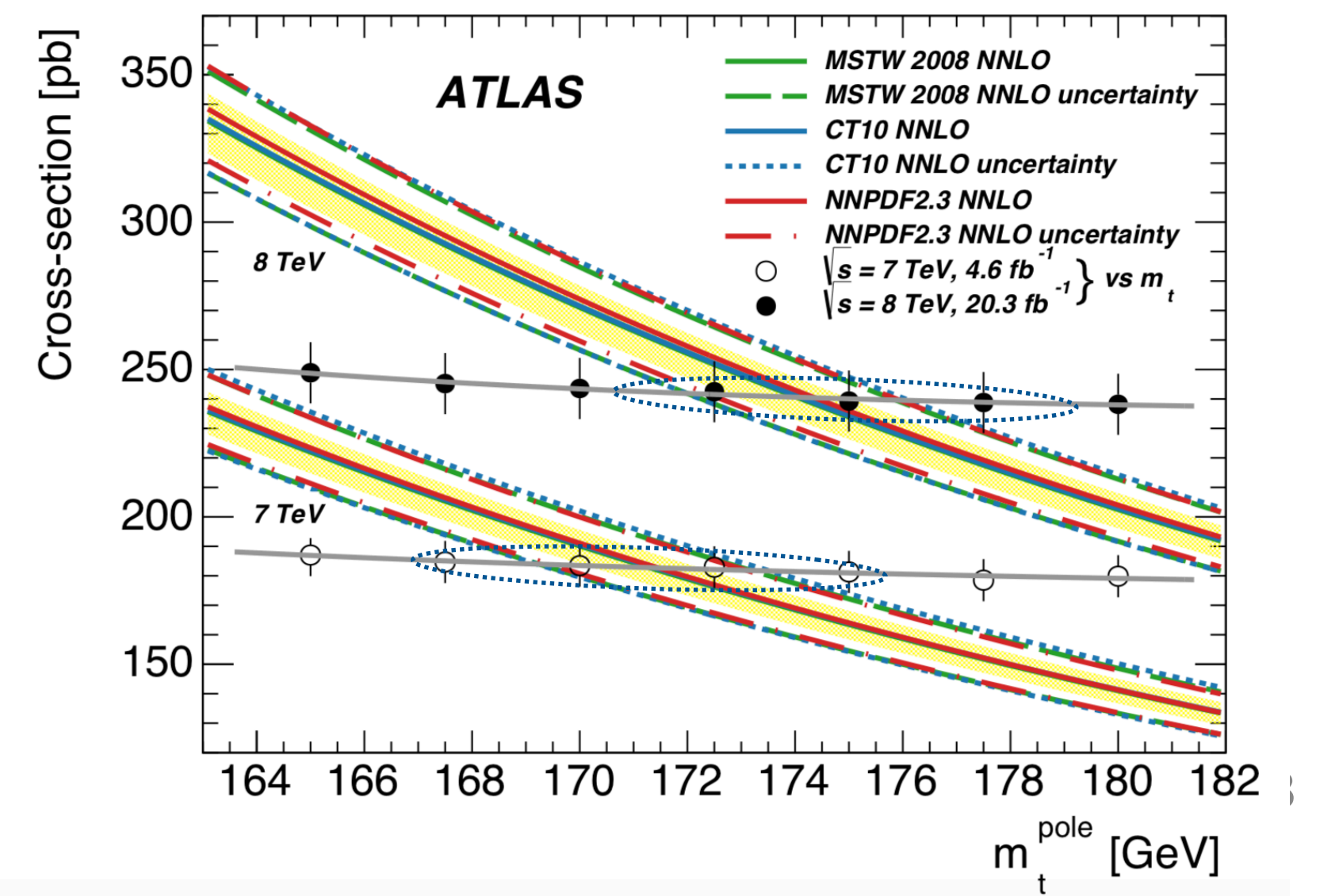
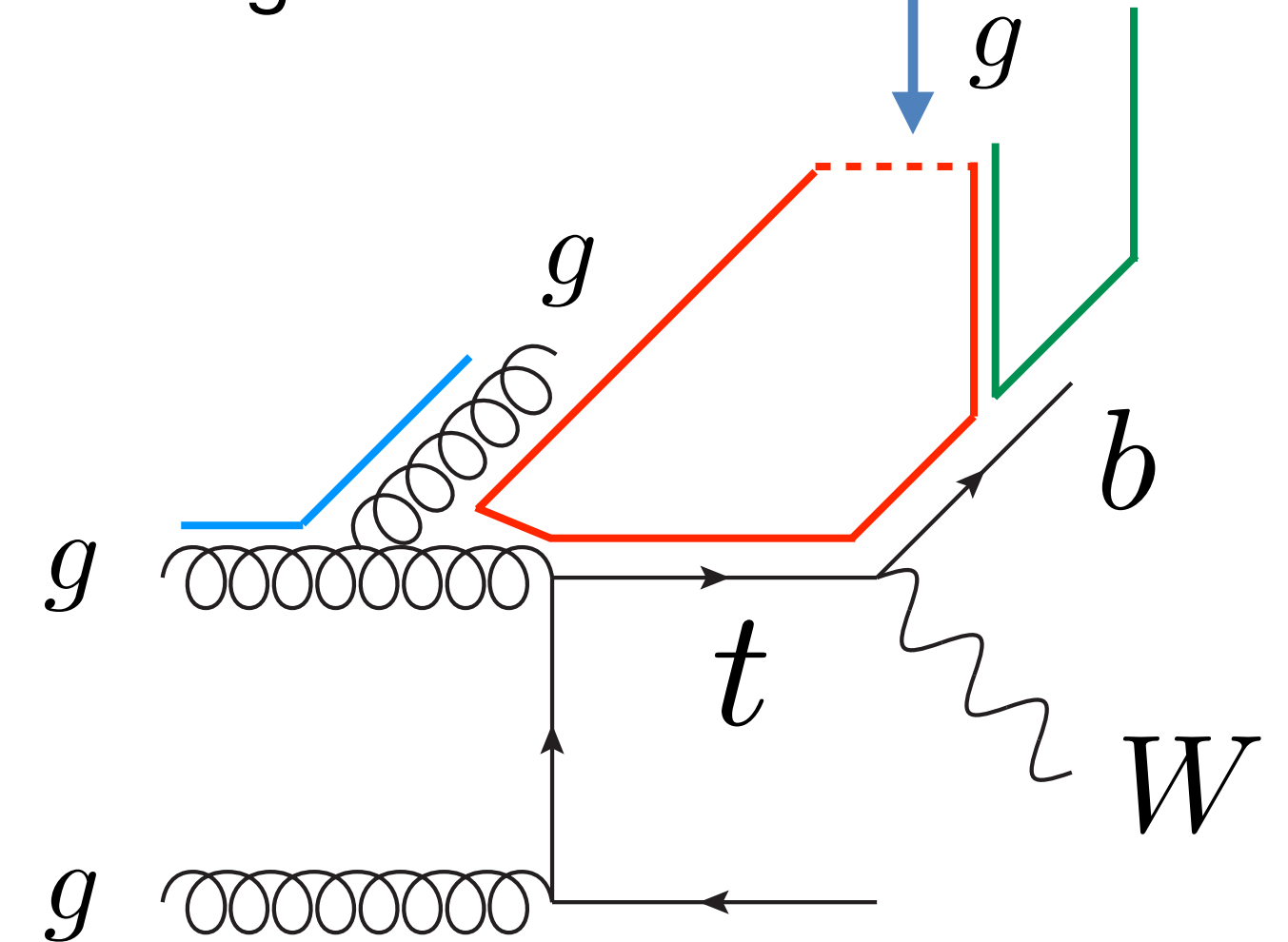

# Digression on the Mass Measurement

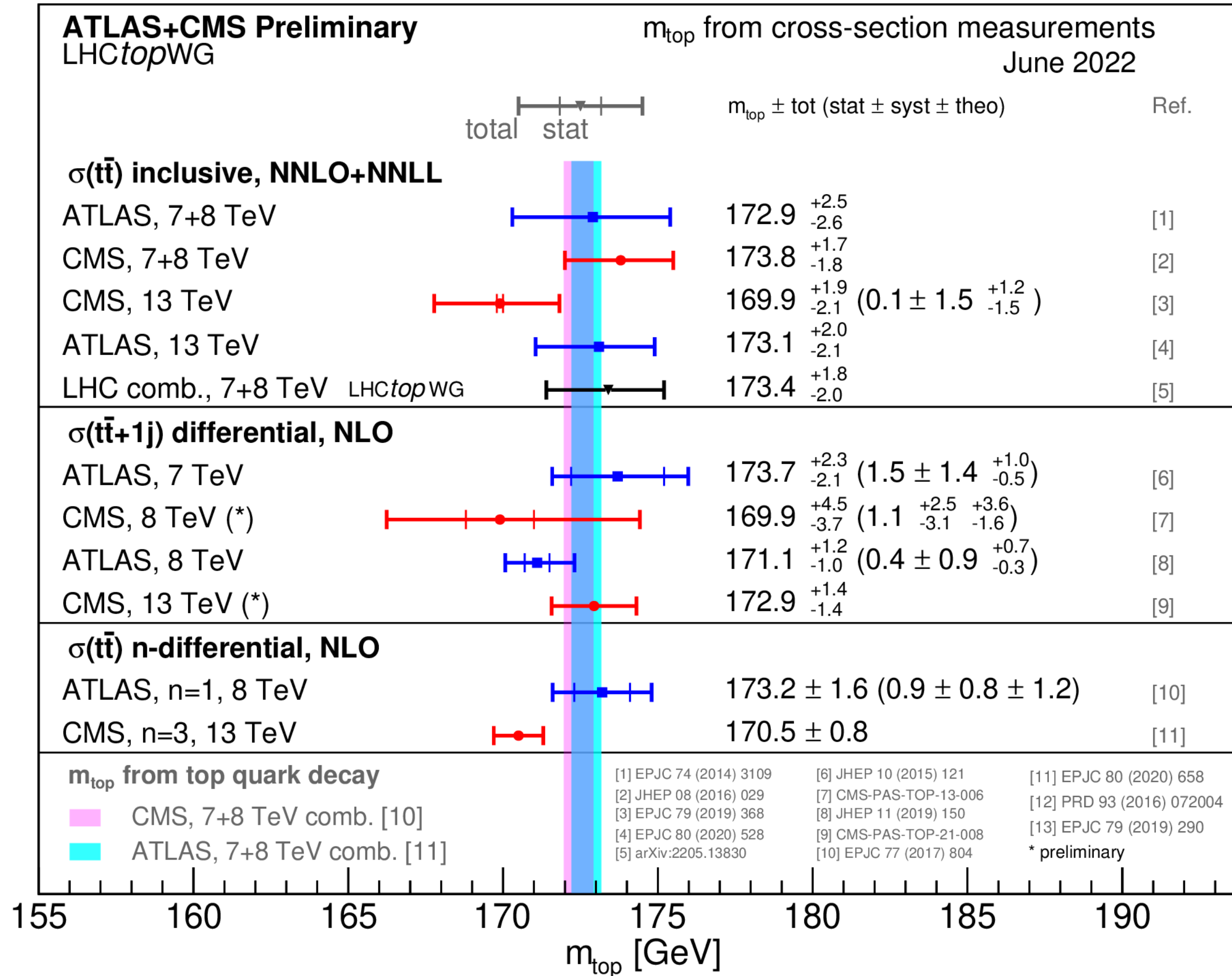

## Study of the reach in precision at HL-LHC

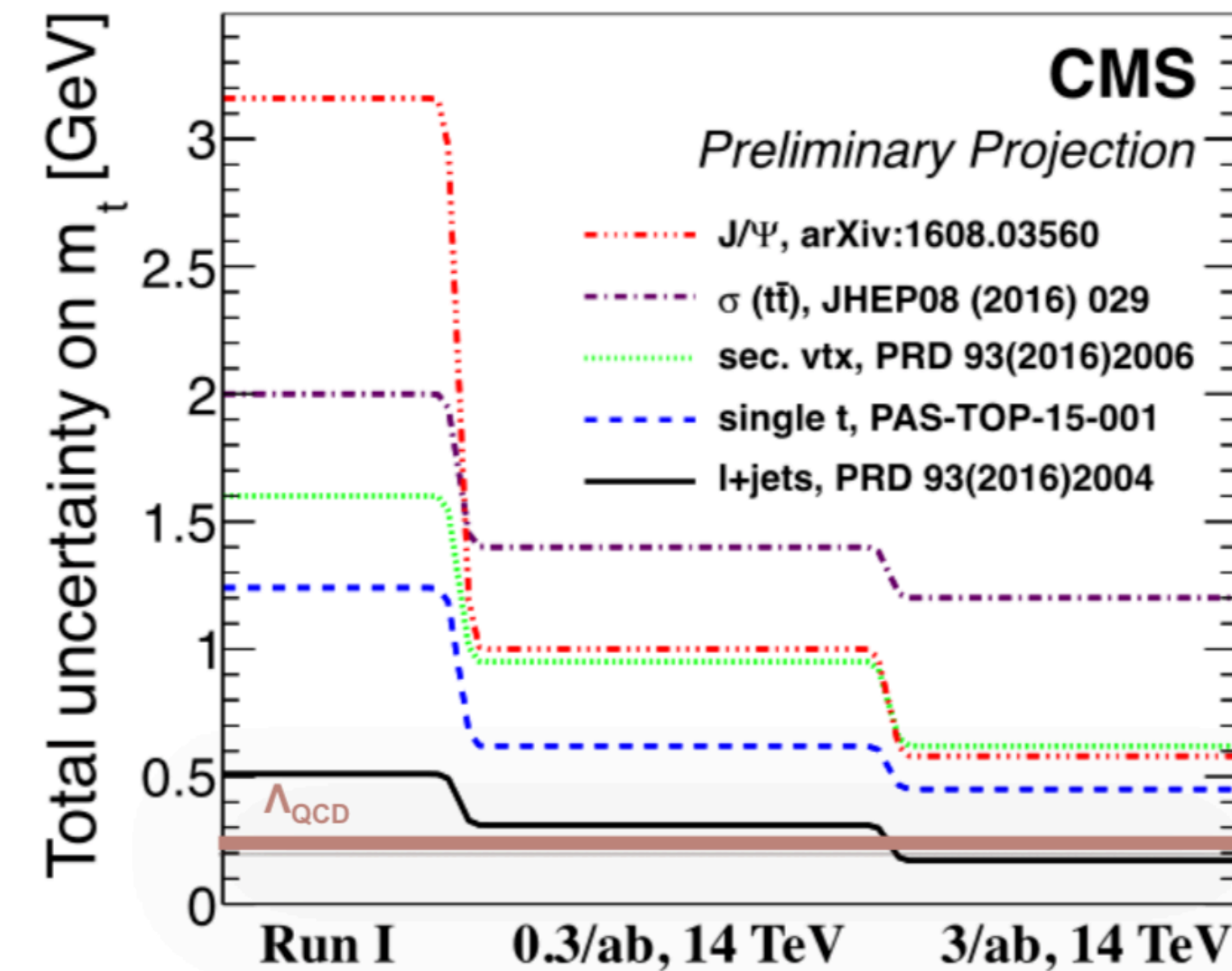

Reaching a floor in the precision on the top mass at around HL-LHC Lambda QCD ~180 MeV

**Measurements from cross sections will be limited by prediction uncertainties and luminosity.**

# Rare single top production

## Rare single top process observation

$tq\gamma$  Single-top quark and a photon

Powerful probe of top-EW coupling (and constraints on new physics)

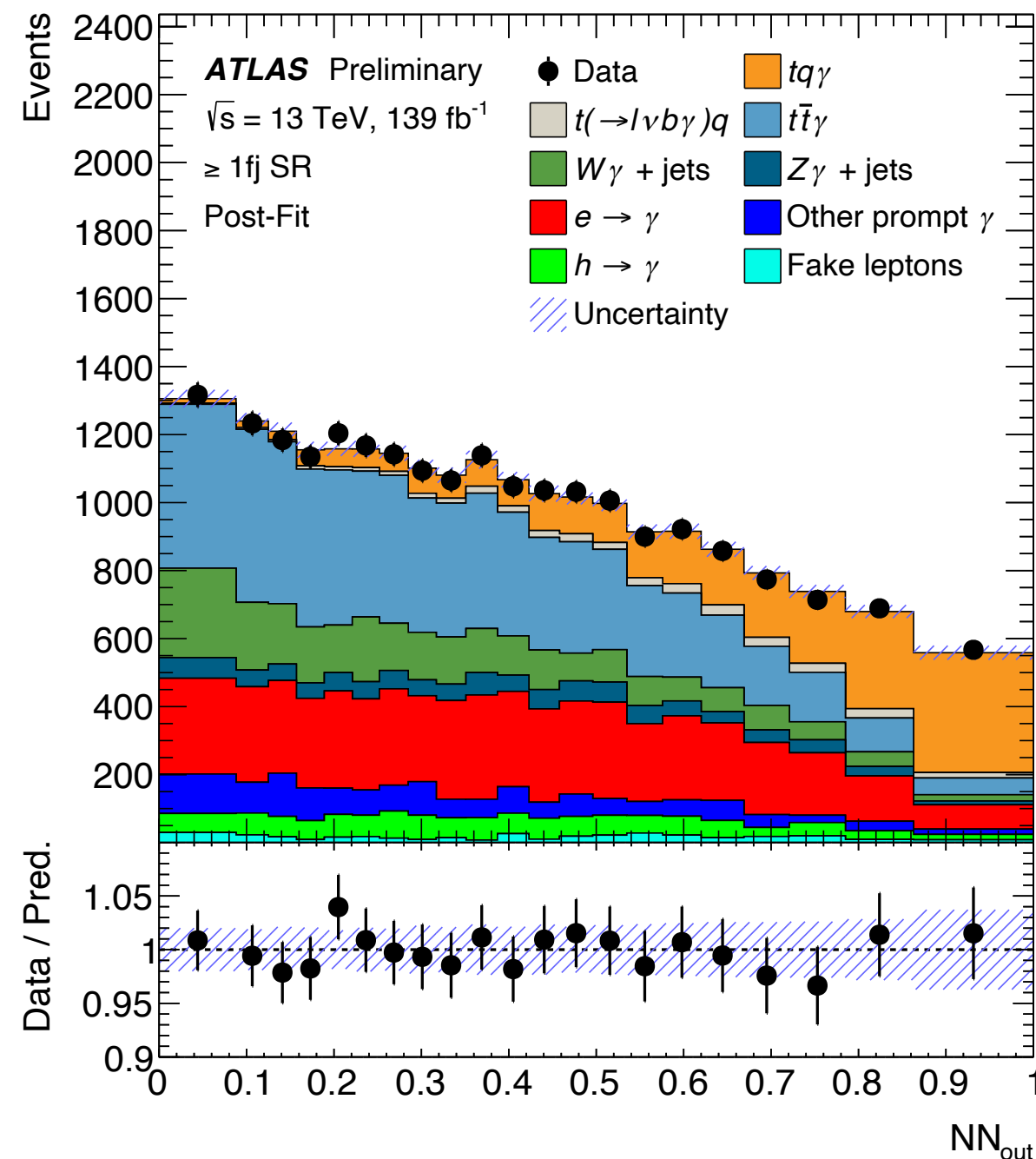
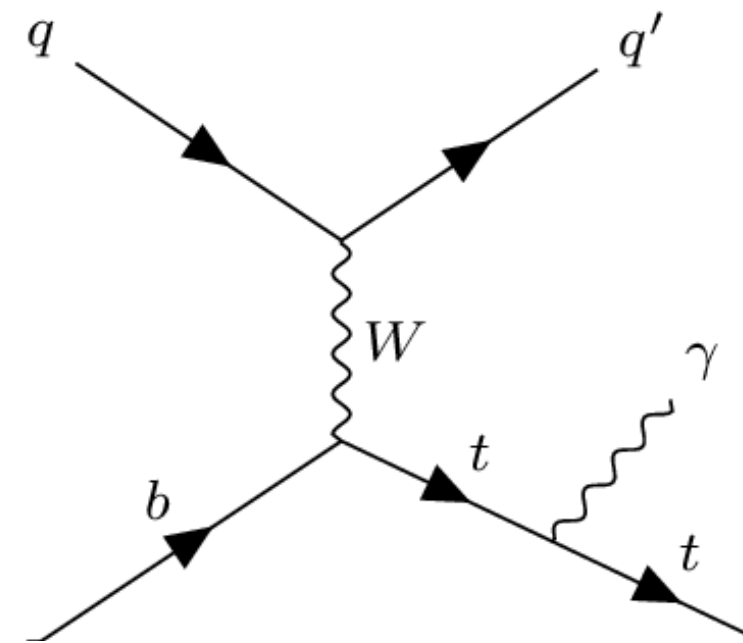

Search in the semi-leptonic top decay mode

Requires 1-forward jet

$$2.5 < |\eta_{\text{jet}}| < 4.5$$

## S-channel single top production

More challenging at higher energies to the smaller relative increase w.r.t. top pairs

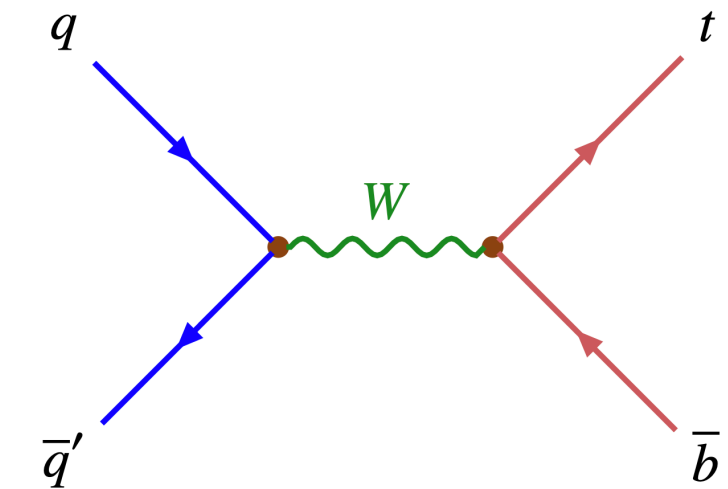

Lowest cross-section measurement of all single-top processes!

Same sensitivity as Run 1 with 7 times more data!

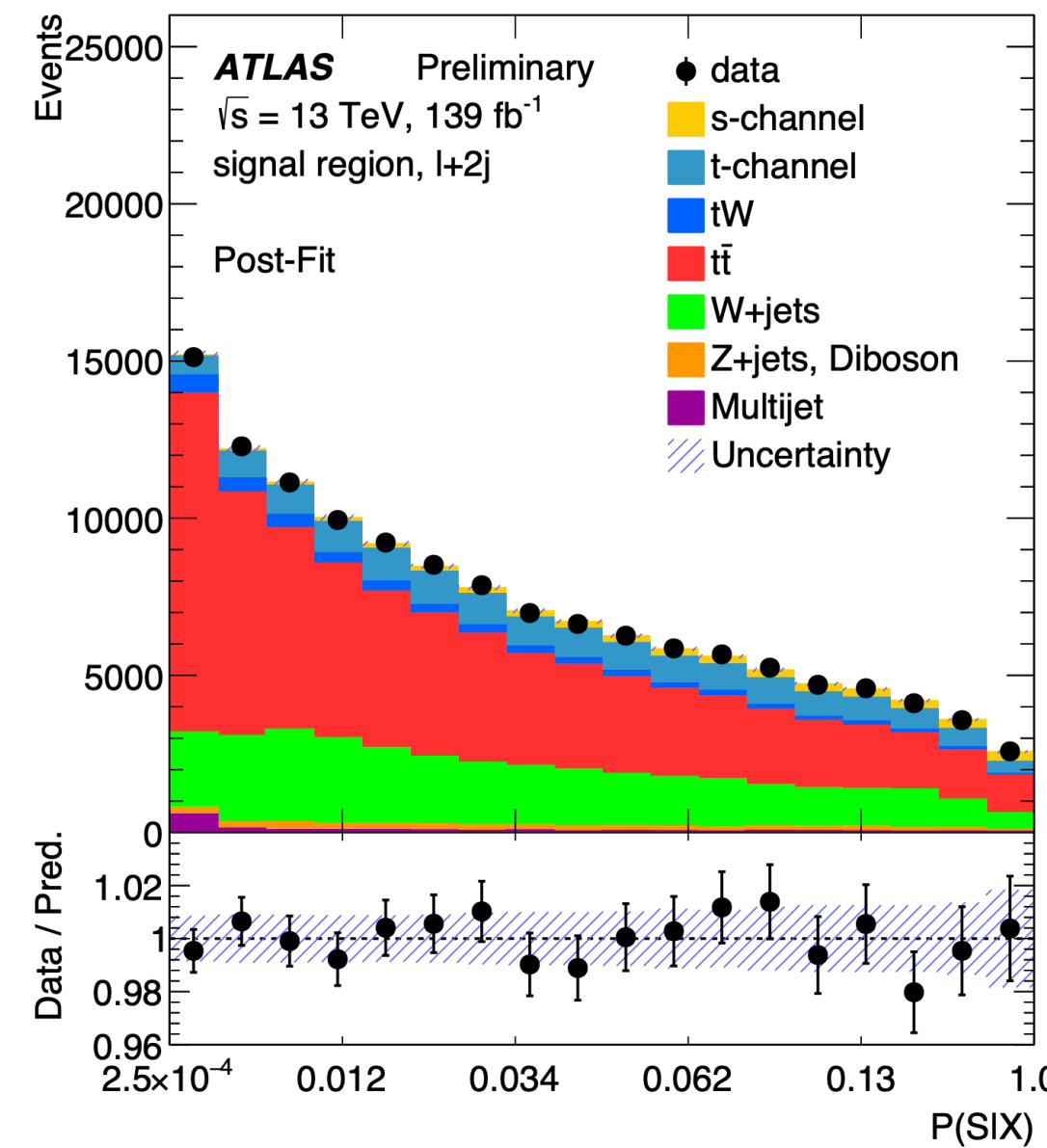

Matrix Element Probability for a given event X to be a signal event S  $P(S|X)$

Measurement dominated by systematic uncertainties:

$$\sigma_s = 8.2^{+3.5}_{-2.9} \text{ pb} \quad \sigma_s^{SM} = 10.3 \pm 0.4 \text{ pb}$$

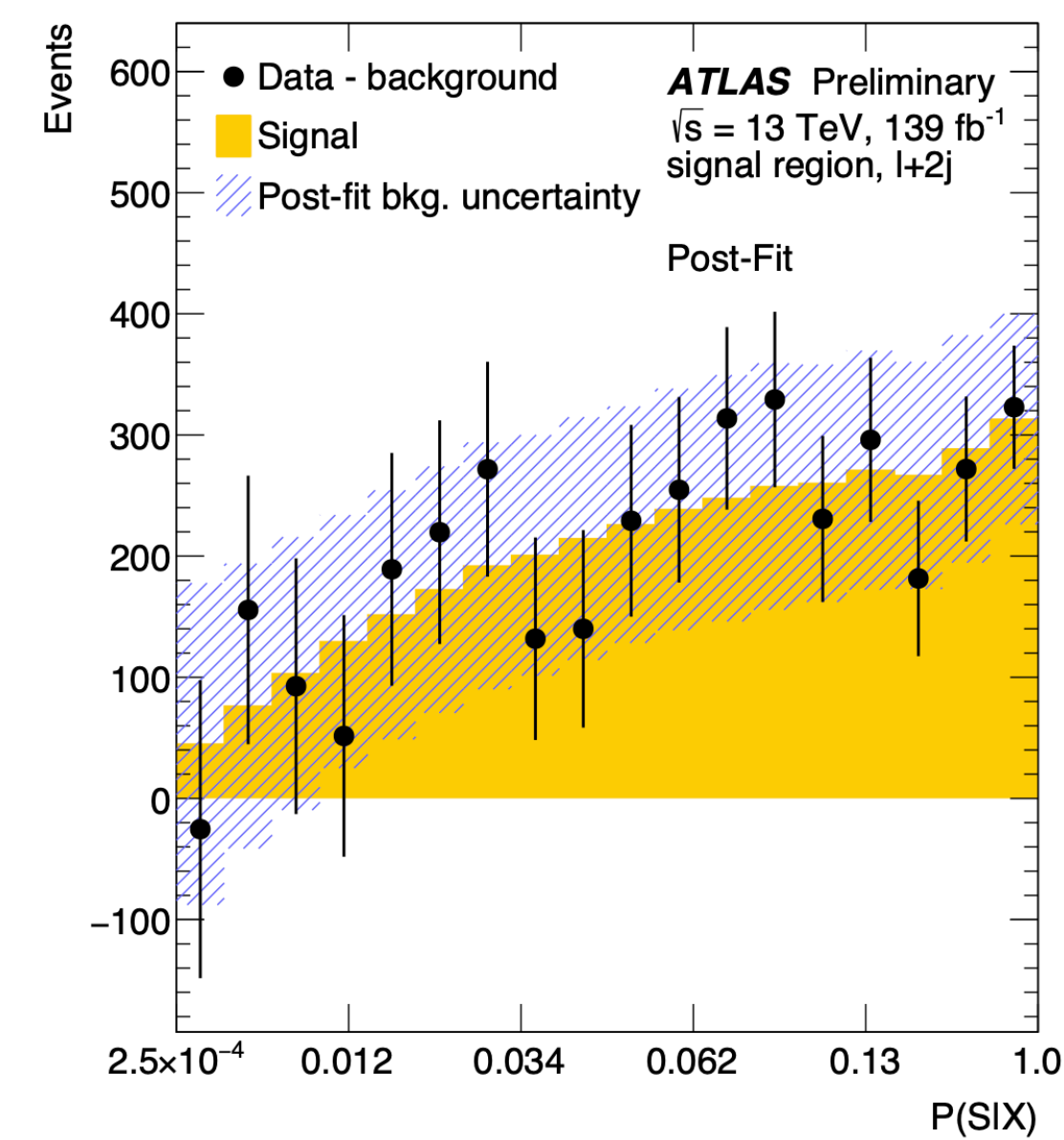

3.3σ Observed (3.9 σ expected)

Prediction at NLO QCD

Main systematic:

W-jets and top modelling

Jet energy scale and resolution

# Top Physics

## Four top quark production

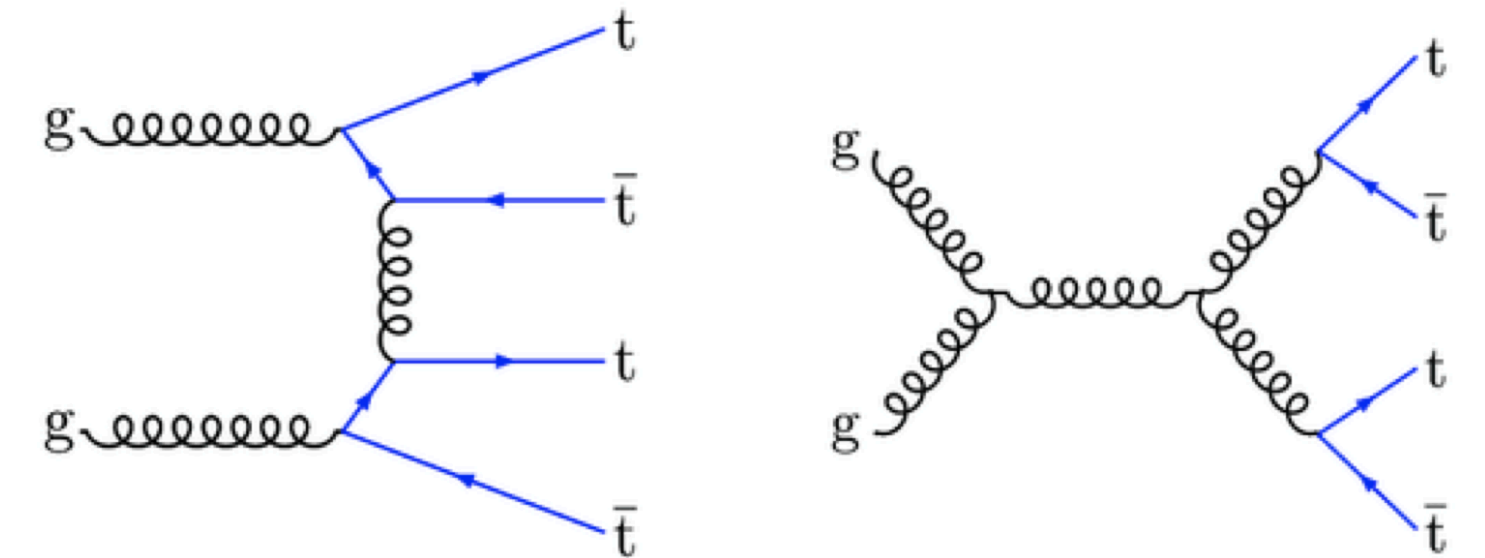
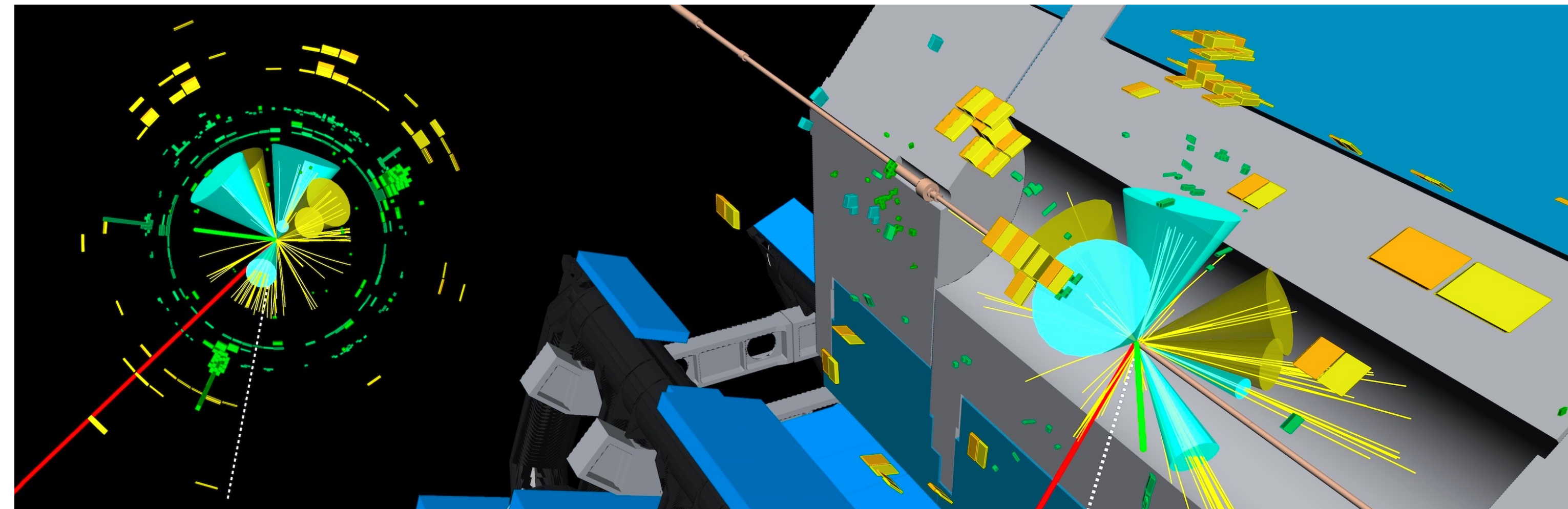

$$\sigma_{t\bar{t}t\bar{t}}^{SM} = 12.0 \pm 2.4 \text{ fb}$$

Final state with four W bosons and four b jets!

**New intricate search channel:** 1 lepton (and 2 leptons opposite sign) with up to 10 jets and 5 b-jets!!

*57% of the four top events!*

Much more intricate than the 2 Same sign leptons (larger systematics - from tt-HF modelling)!

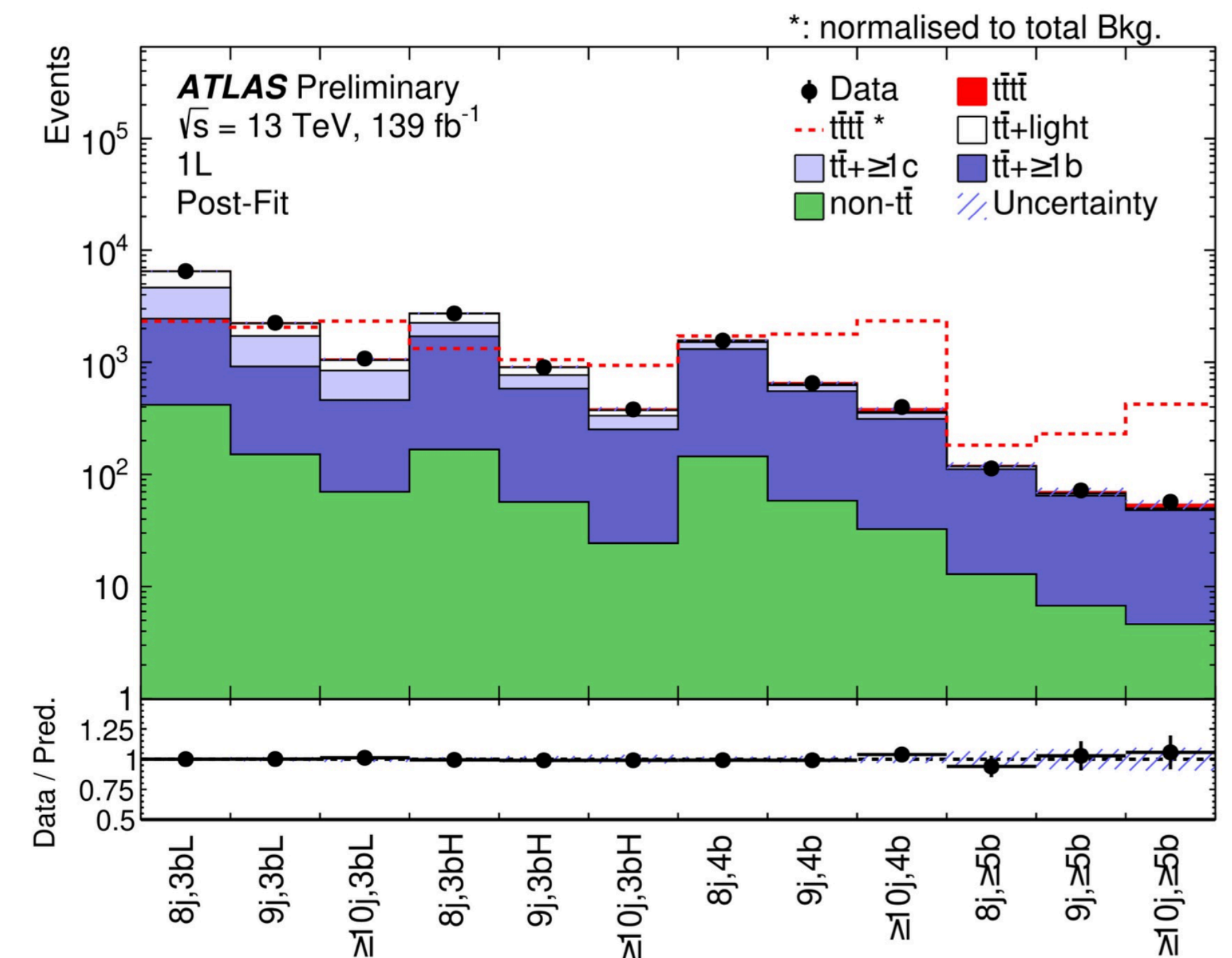
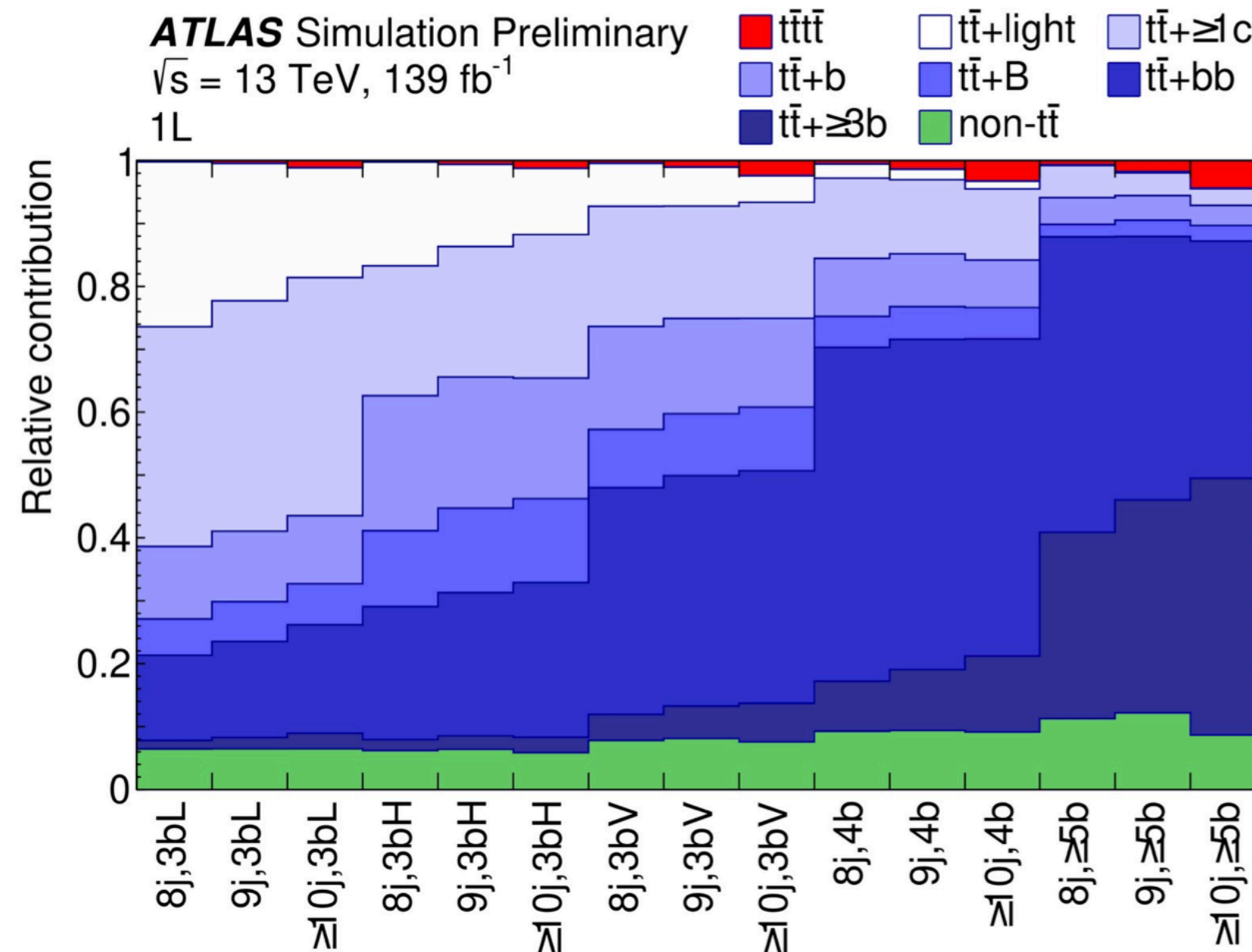

# Top Physics

## Four top quark production

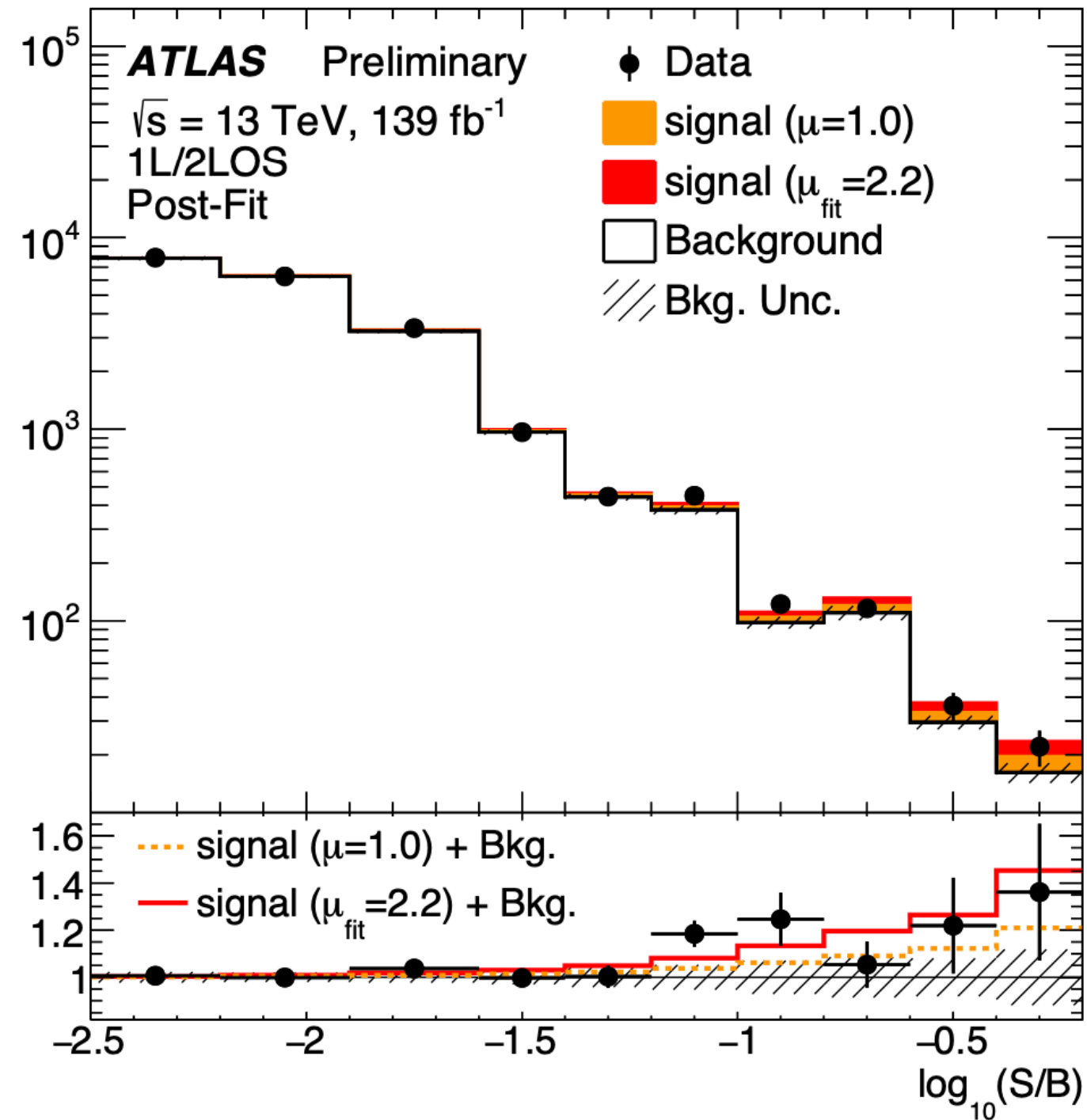

Cross section measurement (dominated by systematics)

$$\sigma_{t\bar{t}t\bar{t}} = 26 \pm 8 \text{ (stat.) }^{+15}_{-13} \text{ (syst.)}$$

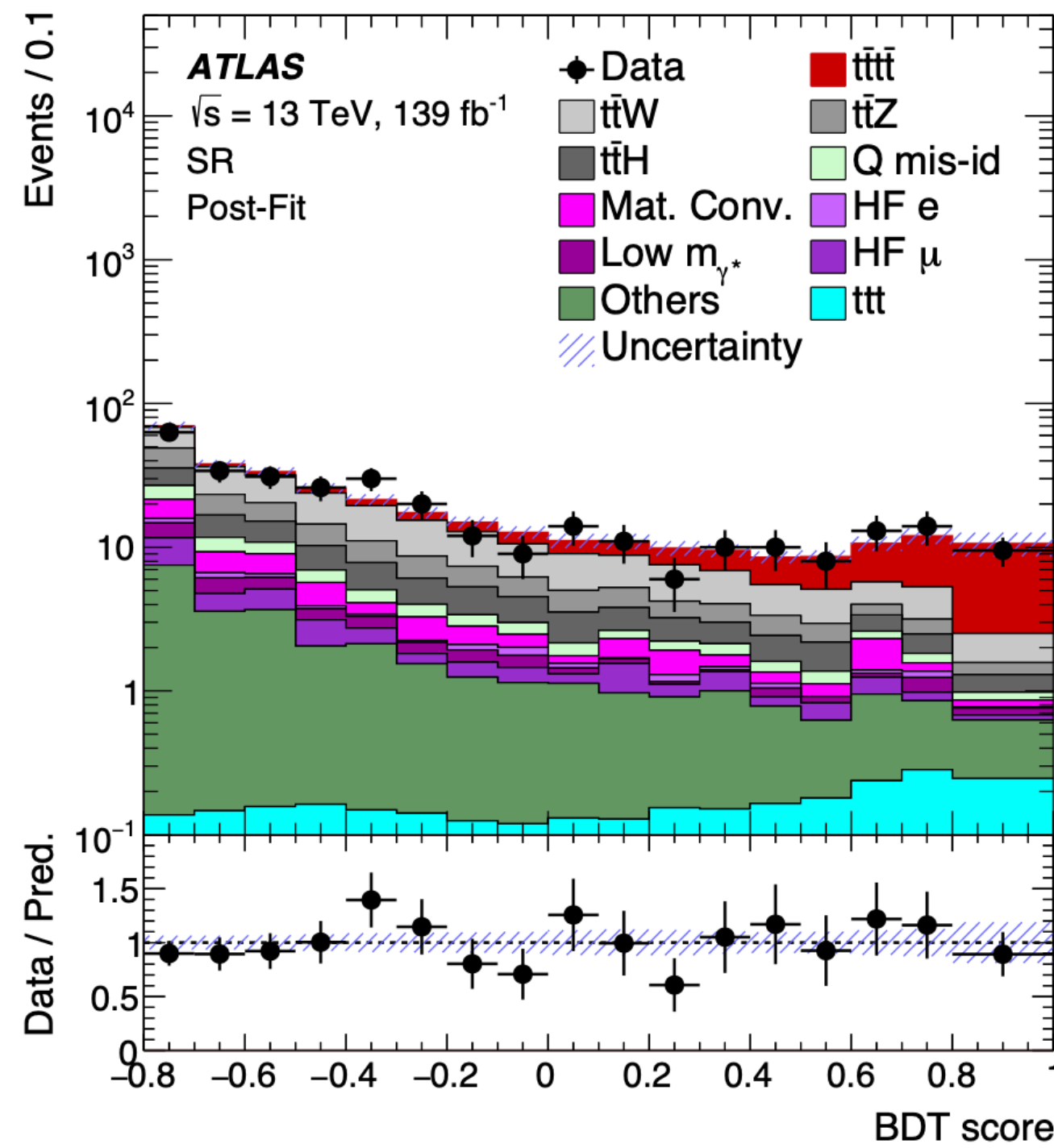

Combined cross section measurement:

$$\sigma_{t\bar{t}t\bar{t}} = 24 \pm 4 \text{ (stat.) }^{+5}_{-4} \text{ (syst.)} = 24^{+7}_{-6} \text{ fb}$$

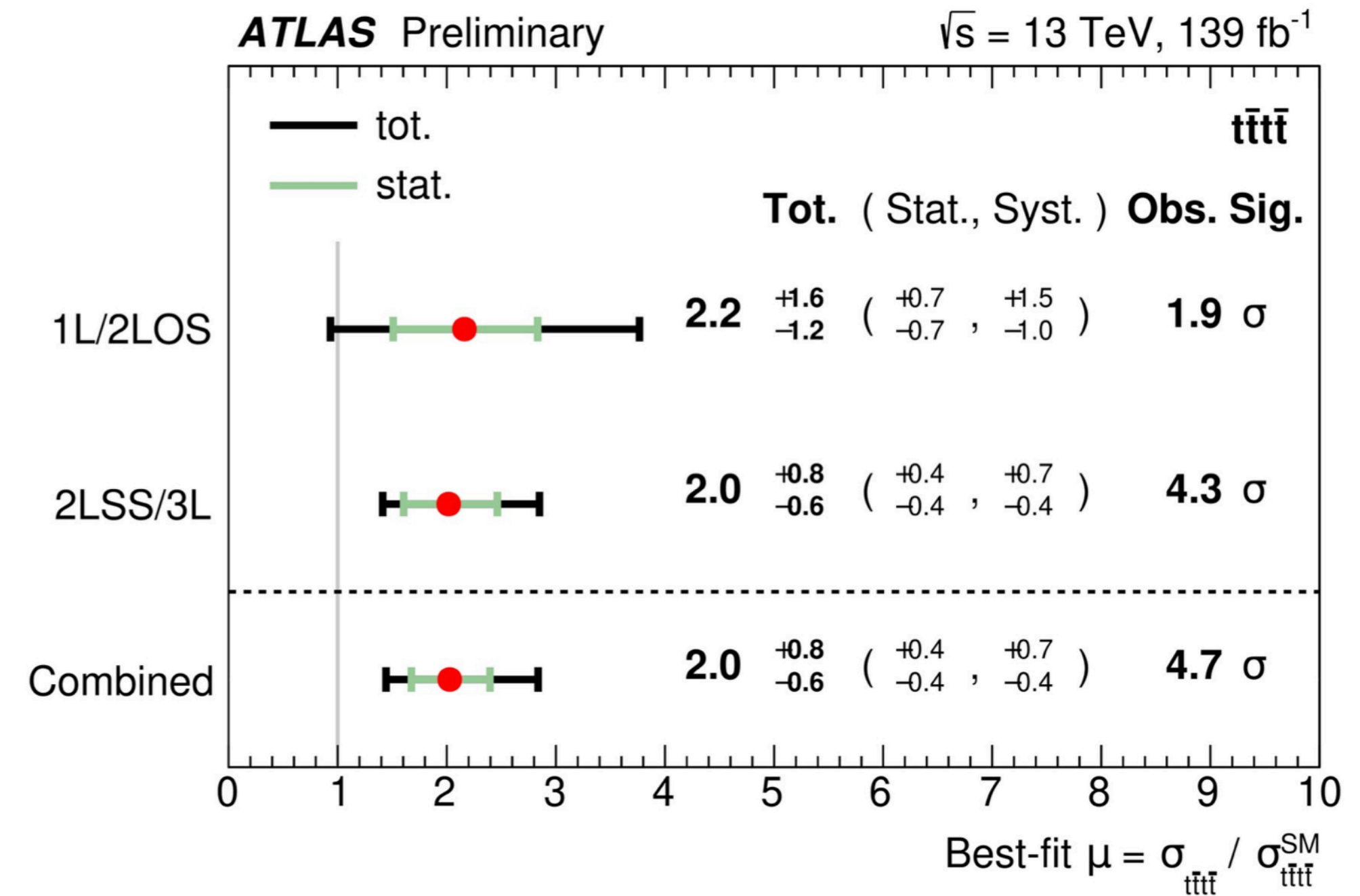

Combined significance of observation: **4.7 $\sigma$  obs.** (2.6 exp.)



# Diboson production

In a nano nutshell

# Di- (and Tri-) boson measurements at the LHC

Large number of diboson processes measured and used to constrain anomalous gauge couplings

## Diboson Cross Section Measurements

Status: July 2017

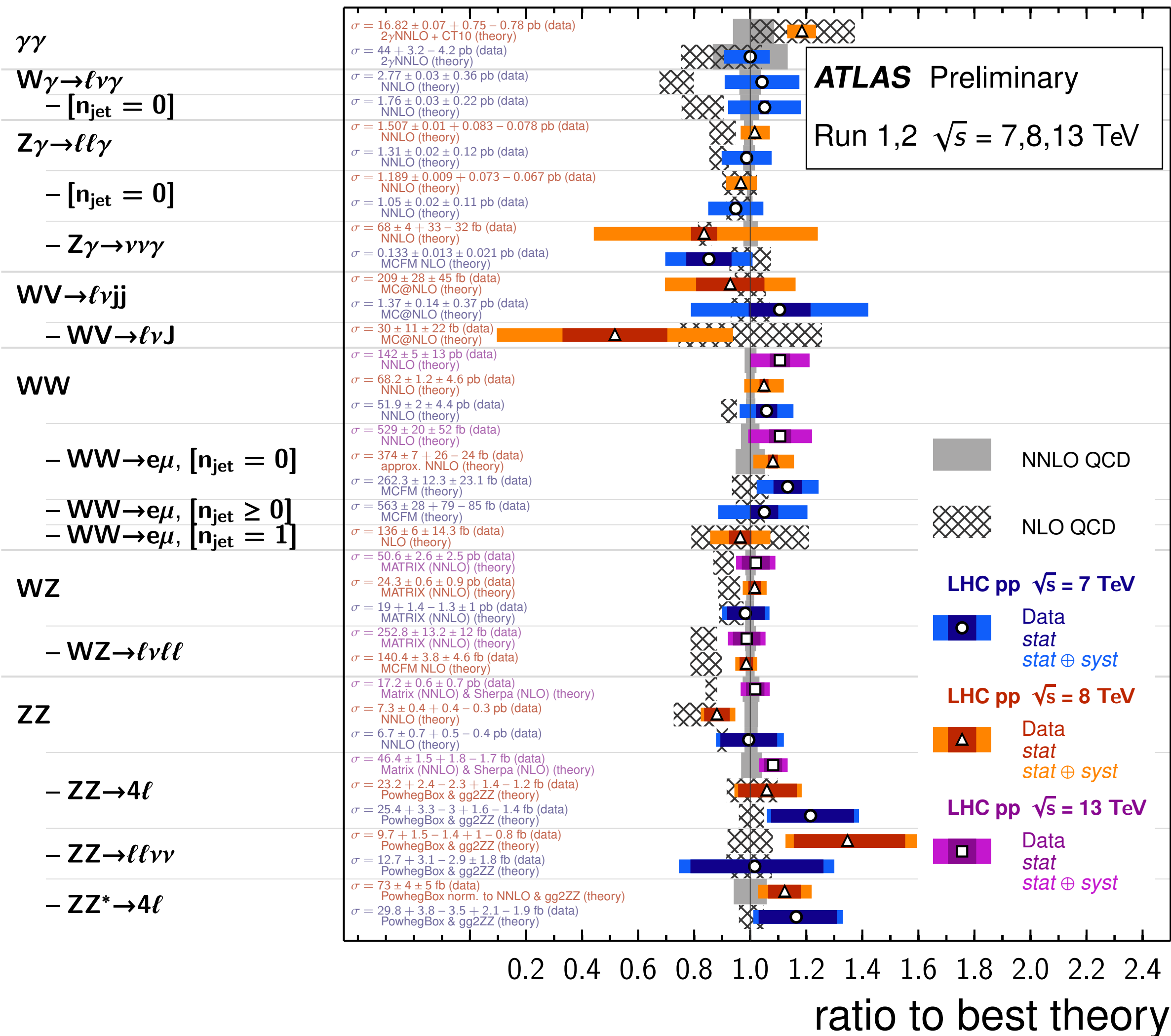

## Measuring more rare and difficult processes

### VBF, VBS, and Triboson Cross Section Measurements

Status: August 2016

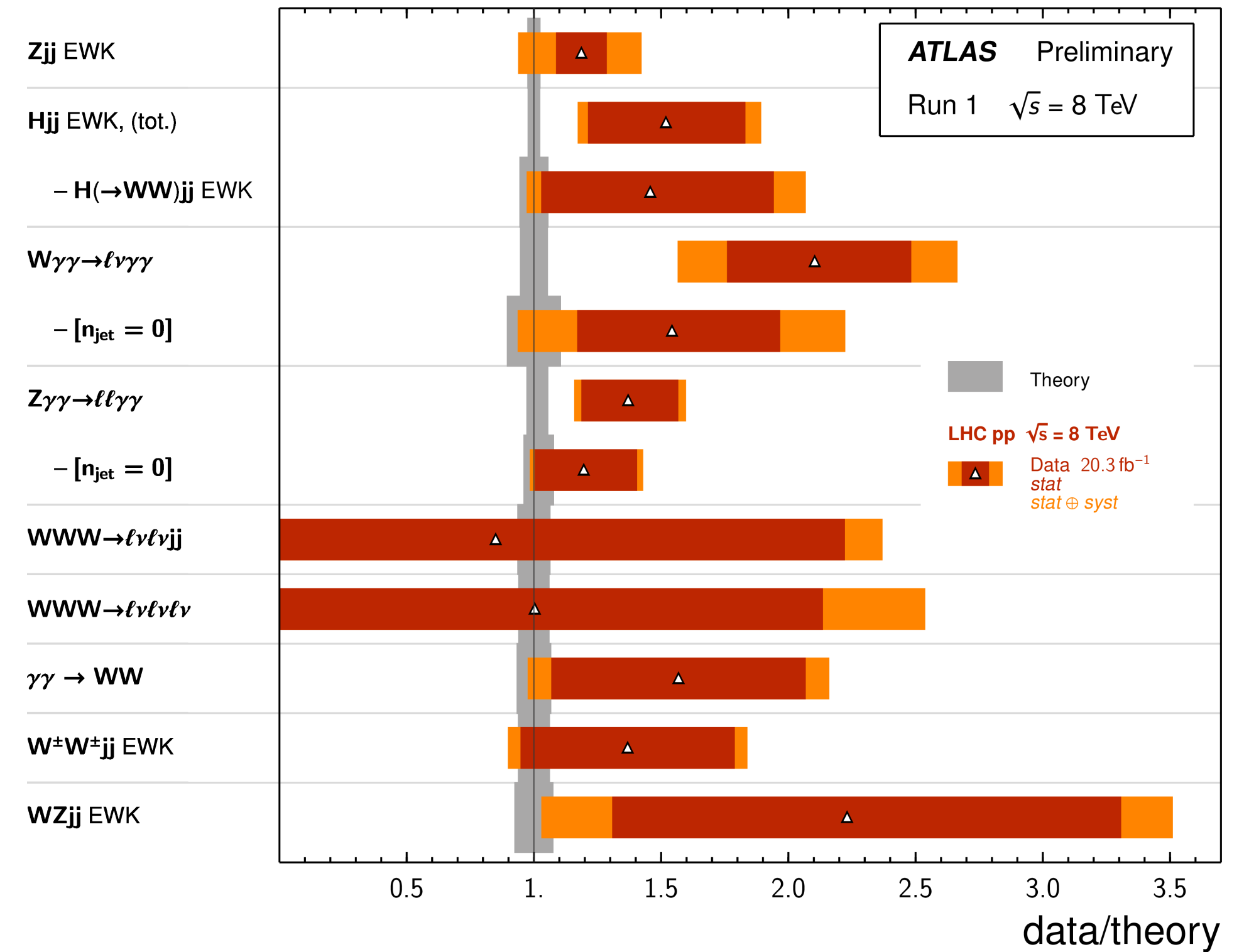

# Tri-boson WWW Observation!

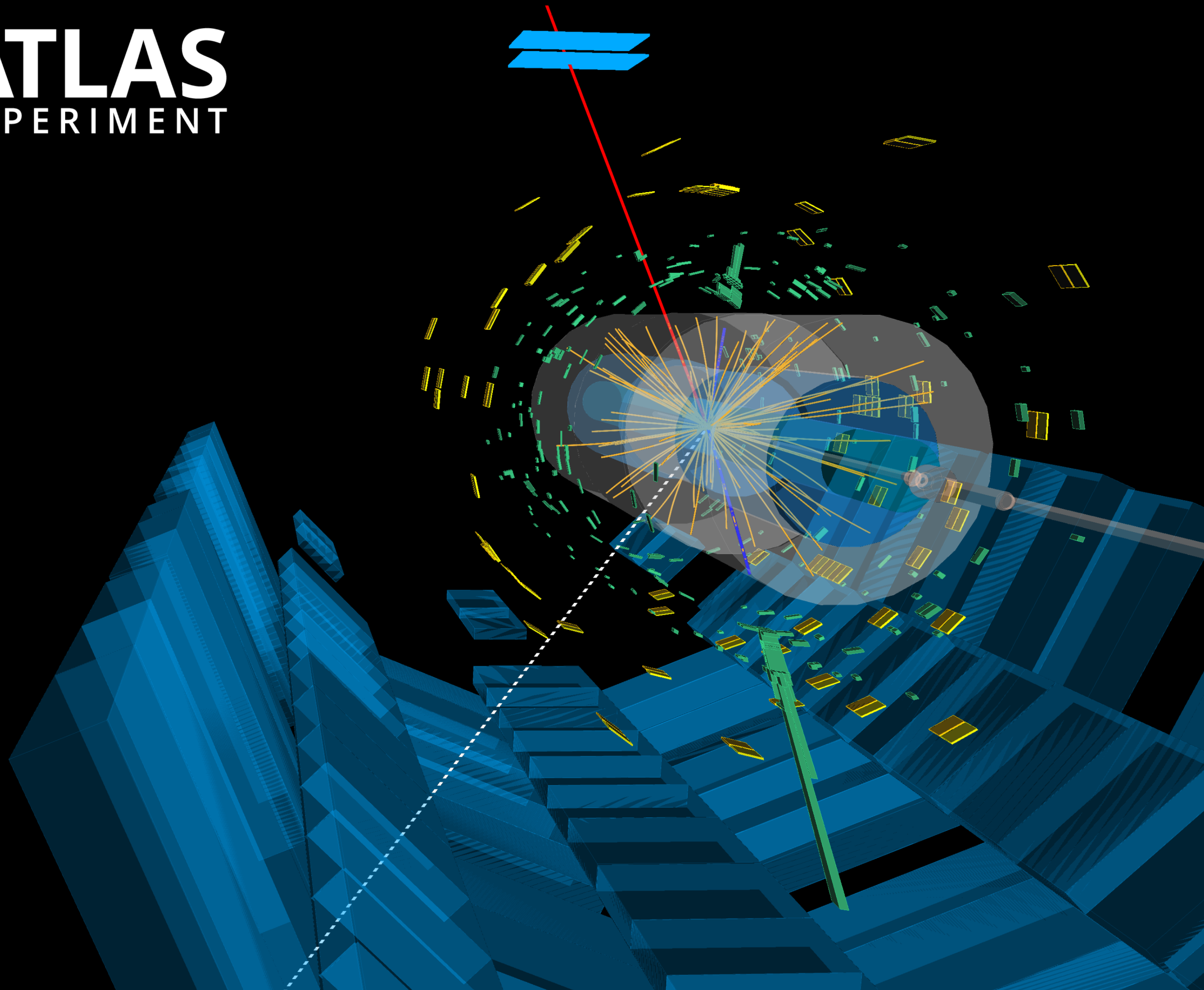
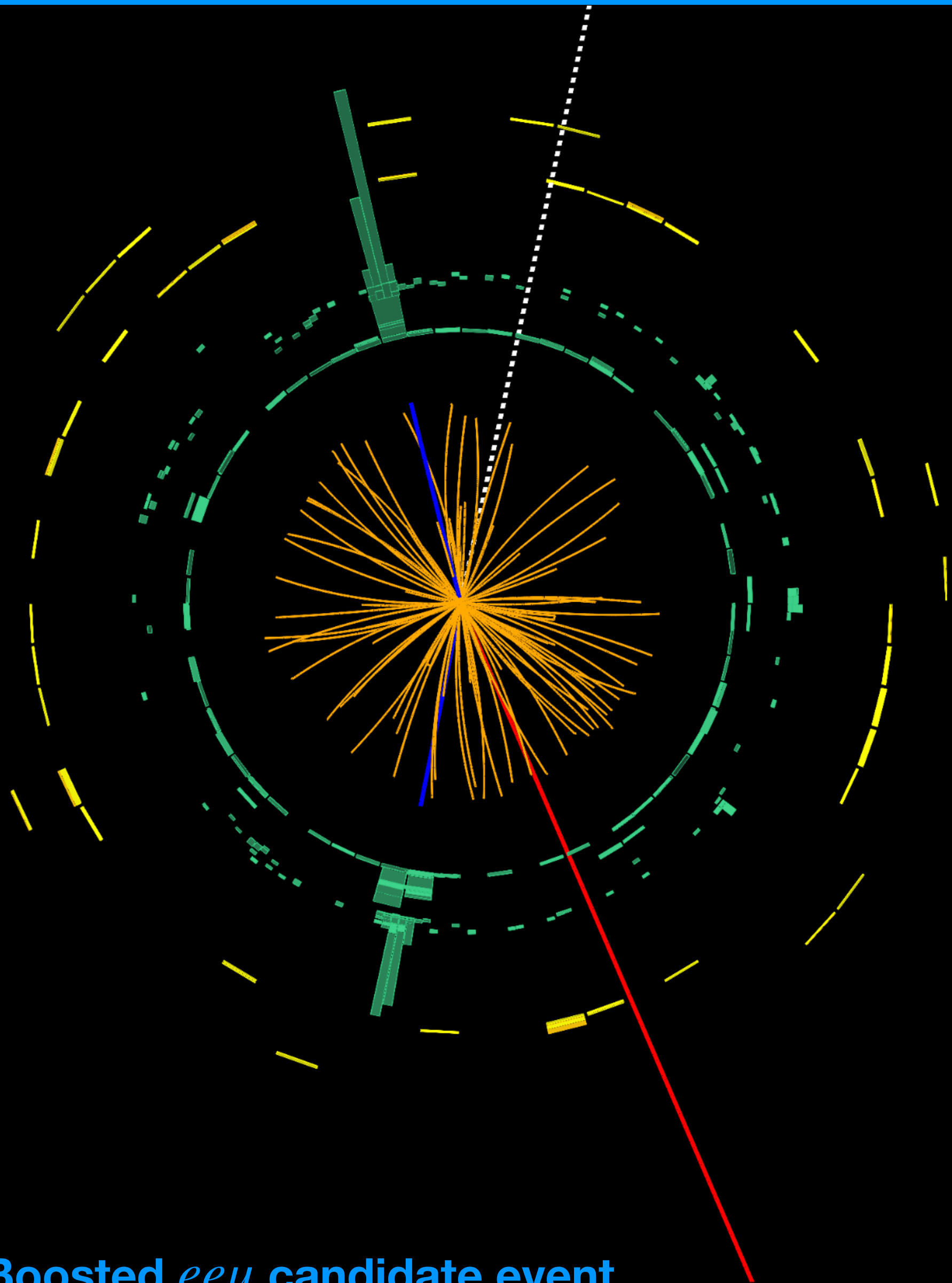

Boosted  $ee\mu$  candidate event

# Triboson $W^\pm W^\mp W^\mp$ observation

## Search for three W bosons production

Last year shown observation of four top-quark production (see [talk](#))!

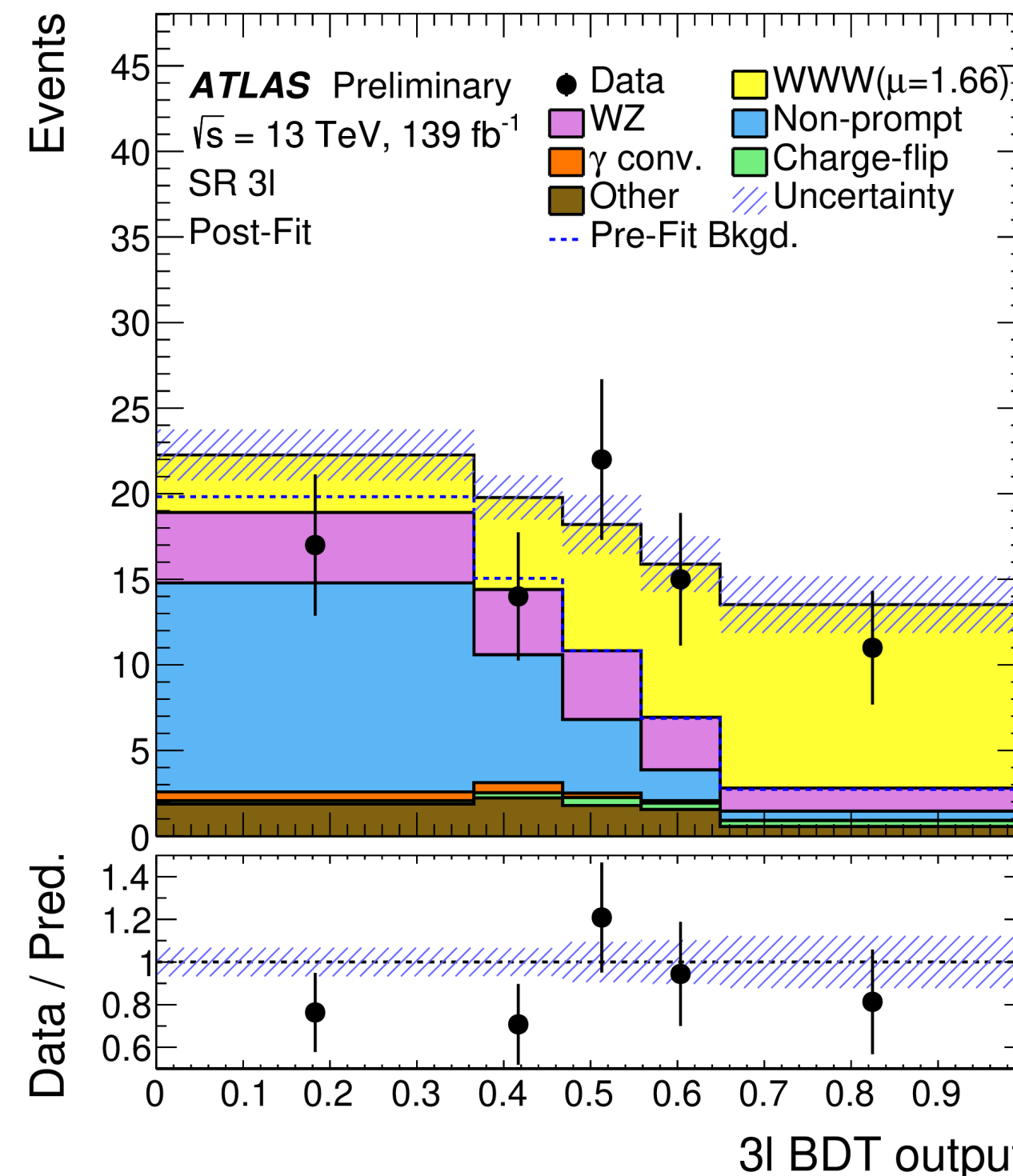
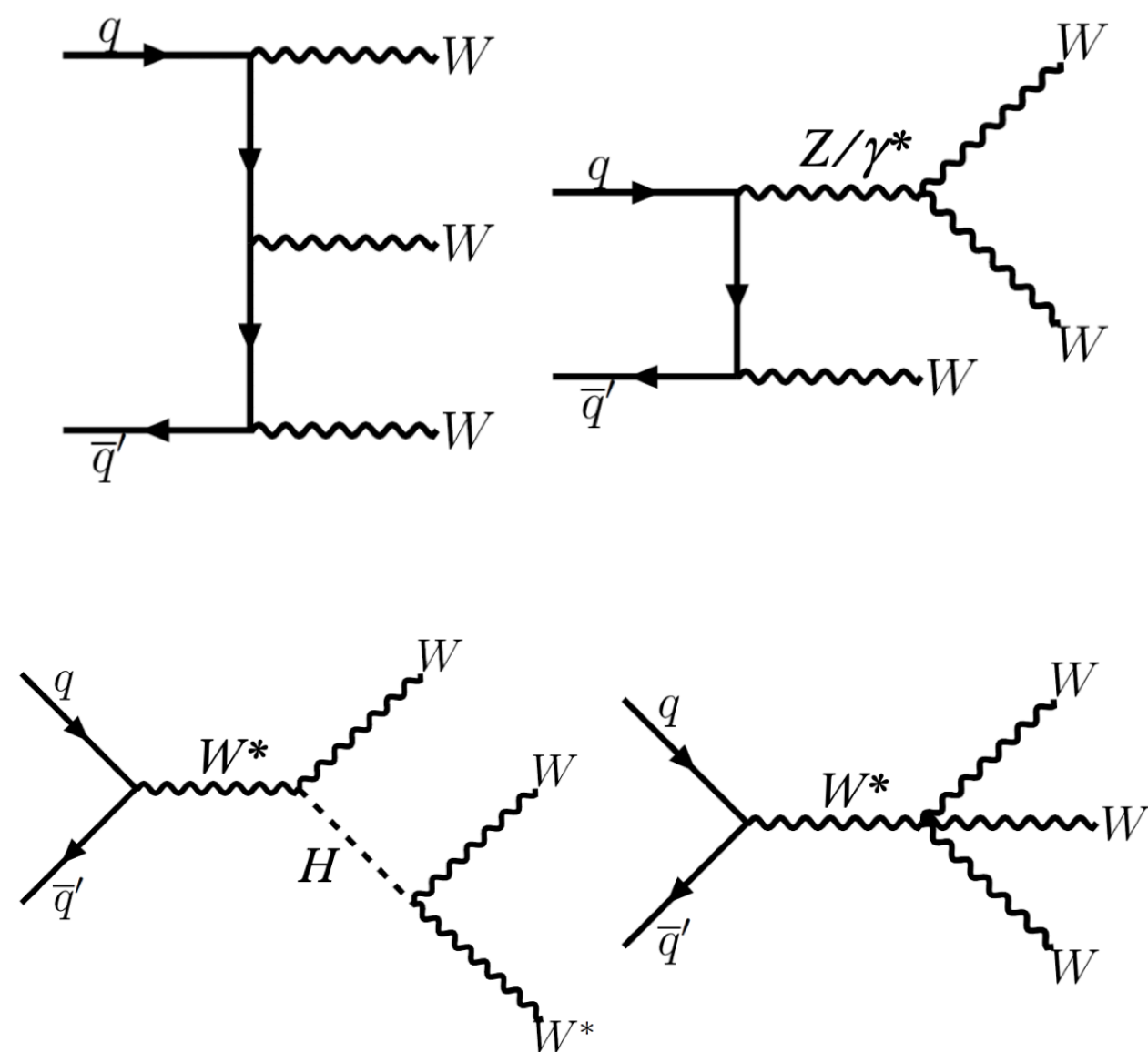

Same sign 2-lepton channel

$$\ell^\pm \nu \ell^\pm \nu jj$$

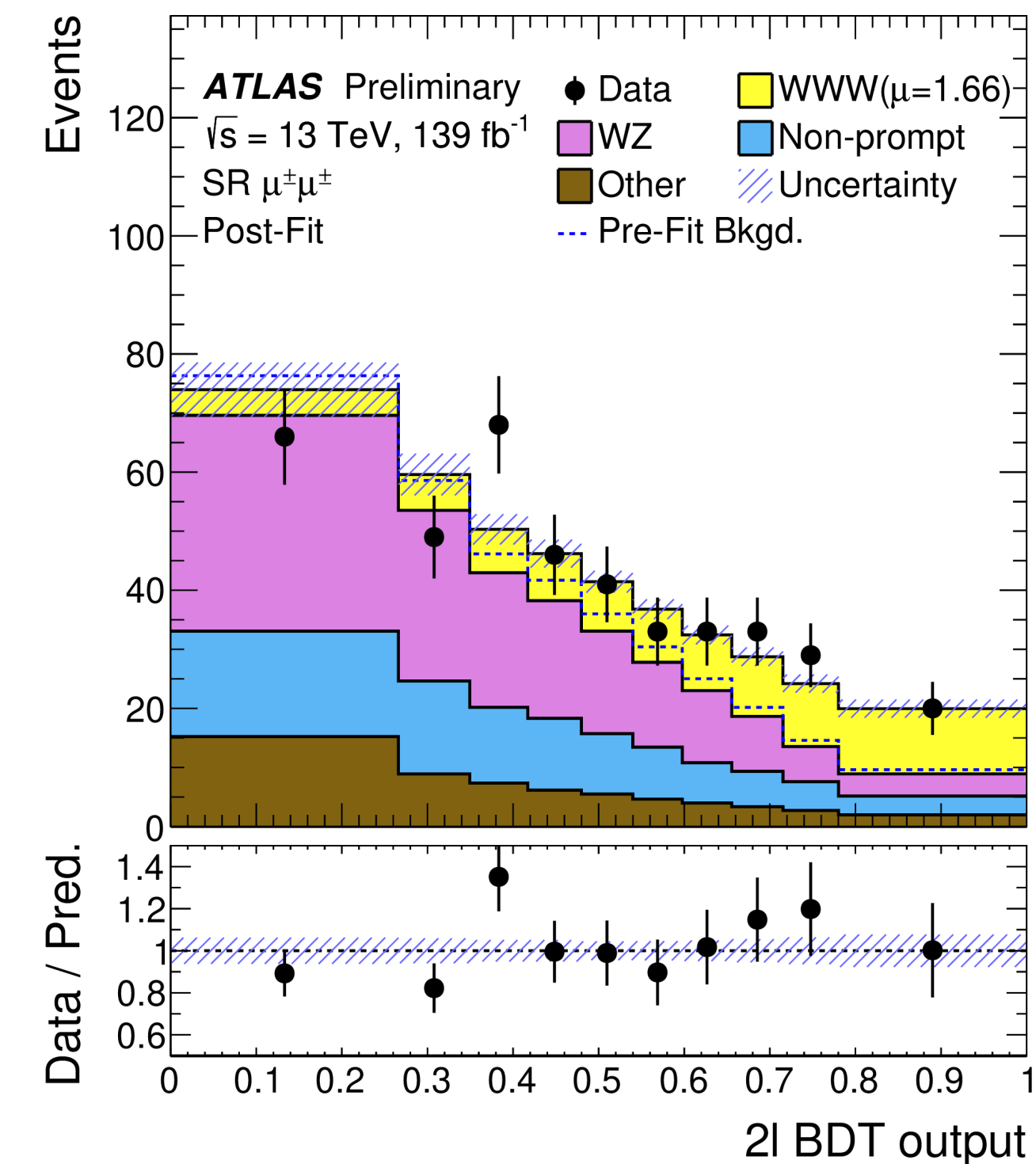

3-lepton channel

$$\ell^\pm \ell^\pm jj$$

First observation of  $W^\pm W^\mp W^\mp$  at  $8.2\sigma$  ( $5.4\sigma$  expected)!

Measured cross section:

$$\sigma(pp \rightarrow WWW) = 820 \pm 100 \text{ (stat.)} \pm 80 \text{ (syst.) fb}$$

**Predictions:**

$pp \rightarrow W^+W^-W^-$	$76_{-3}^{+4}$ (scale) $\pm 2$ (PDF) fb
$pp \rightarrow W^-W^+W^+$	$136_{-5}^{+6}$ (scale) $\pm 4$ (PDF) fb
$pp \rightarrow WH \rightarrow WWW^*$	$293_{-2}^{+1}$ (scale) $_{-5}^{+6}$ (PDF) $\pm 3$ ( $\alpha_s$ ) fb

Compatibility  $2.6\sigma$

# EW Vector Boson Scattering

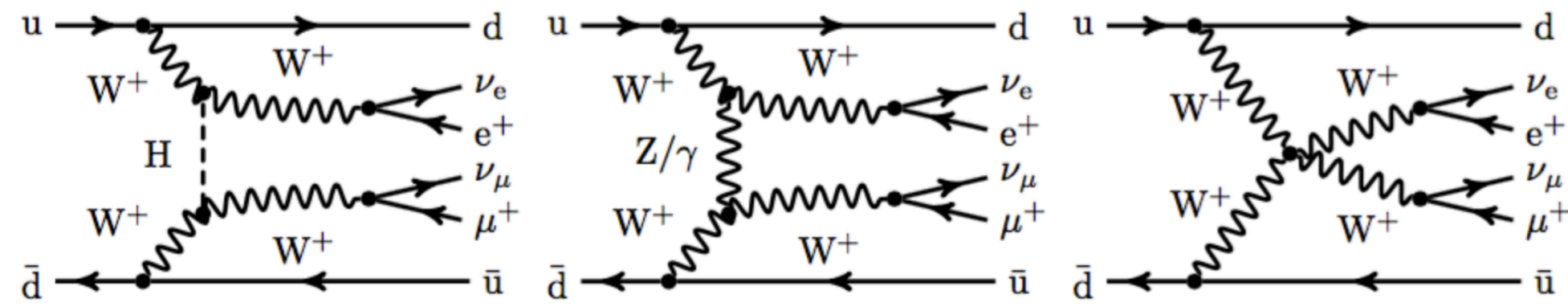

## EW Vector Boson Scattering process

Unambiguously observed by both ATLAS and CMS (at more than  $5\sigma$ ) in the Same sign WW mode. Evidences in the WZ mode.

**WZ**  $5.6\sigma$  ( $3.3\sigma$ )

**WW**  $5.5\sigma$  ( $5.7\sigma$ )

## Longitudinal-Longitudinal Scattering

Important additional check of the EWSB sector.

Suppressed from Higgs cancellation however with very large statistics and polarisation sensitive variables, there is sensitivity to SM LL signal almost  $3\sigma$  for CMS alone.

With ATLAS and more channels WZ and ZZ well above  $3\sigma$

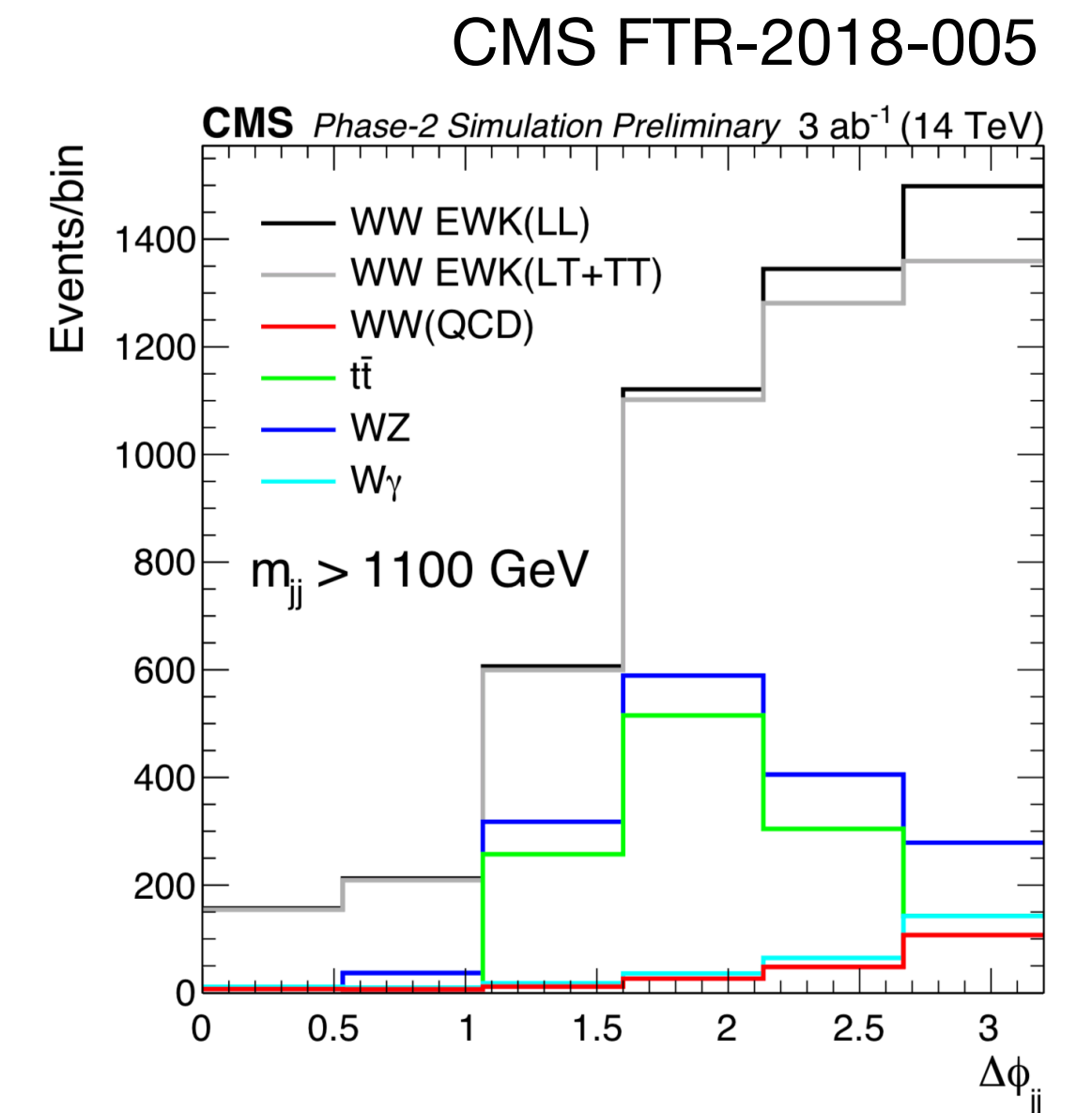
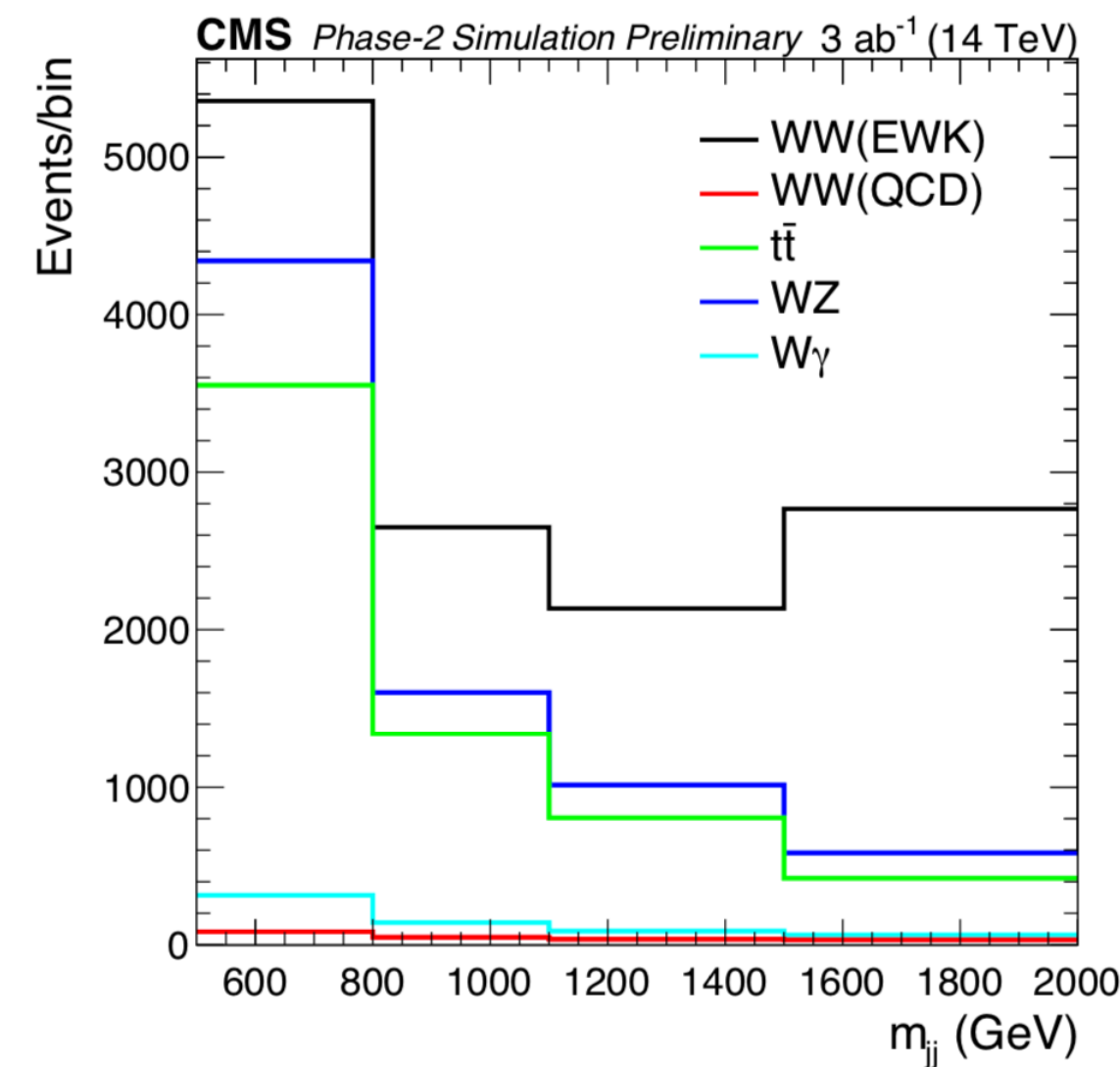
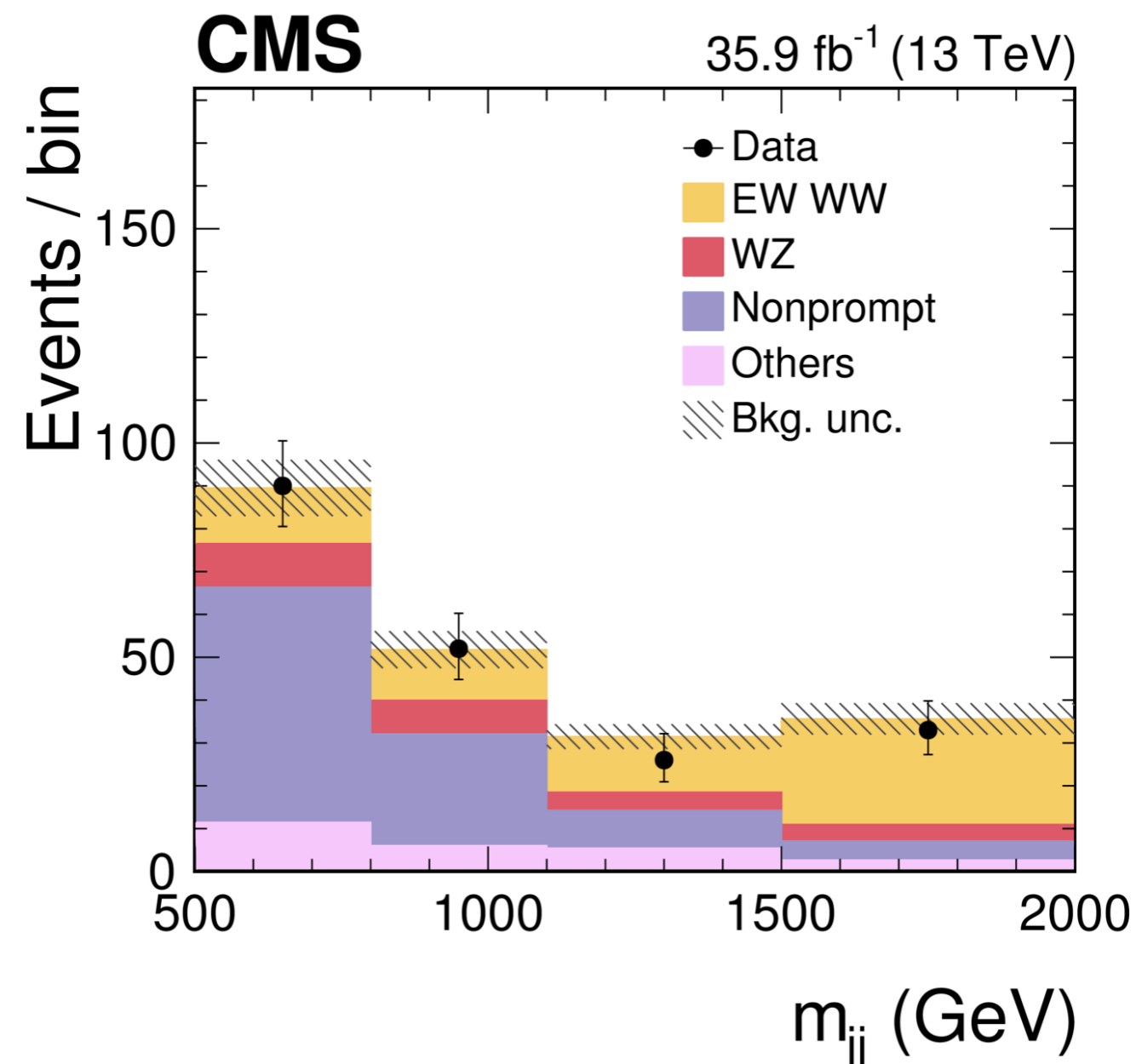
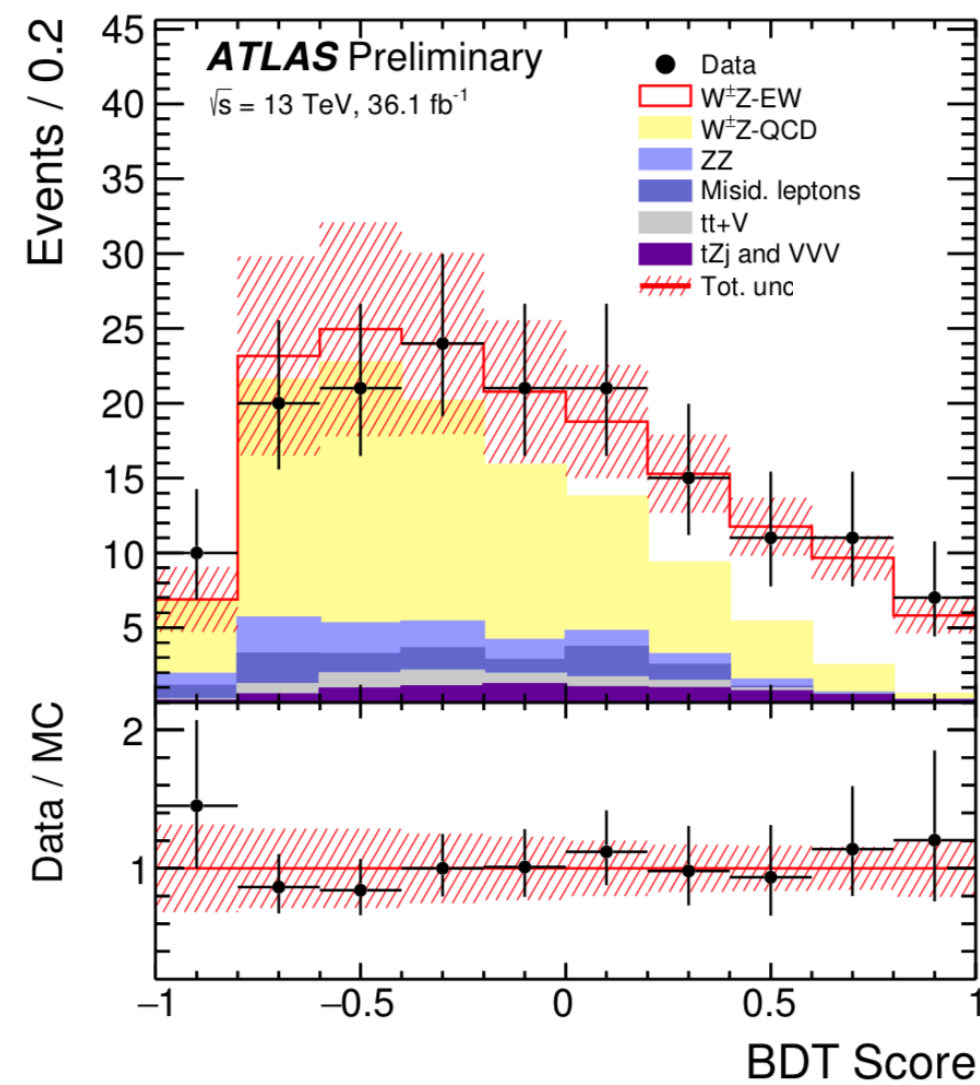

# Global Fit of the Standard Model

# Global Fit of the Standard Model

$$\mathcal{L} = -\frac{1}{4} F_{\mu\nu} F^{\mu\nu} + i\bar{\psi}\not{D}\psi + h.c.$$

## The Electroweak gauge sector

At tree level, fully described by three parameters

$$g, g', \text{ and } v \quad \rho = 1$$

Trade these parameters for precisely measured observables

- The fine structure constant :

$$\alpha = 1/137.035999679(94) \quad 10^{-9}$$

Determined at low energy by electron anomalous magnetic moment and quantum Hall effect

- The Fermi constant :

$$G_F = 1.166367(5) \times 10^{-5} \text{ GeV}^{-2} \quad 10^{-5}$$

Determined from muon lifetime

- The Z mass :

$$M_Z = 91.1876(21) \text{ GeV} \quad 10^{-5}$$

Measured from the Z lineshape scan at LEP

**Note:** we have assumed the existence of a Higgs field giving a vev ( $v$ ) throughout (though we have not discussed the Higgs in detail yet)

At loop level: all other fields enter the game through loop corrections which can be parametrized.

$$G_F = \frac{\pi\alpha}{\sqrt{2}M_W^2(1 - \frac{M_W^2}{M_Z^2})}(1 + \Delta r)$$

$$\sin^2 \theta_W^{eff} = \sin^2 \theta_W \times (1 + \Delta\kappa)$$

$$\bar{\rho} = 1 + \Delta\rho$$

These corrections can then be computed as a function of all other parameters of the Standard Model

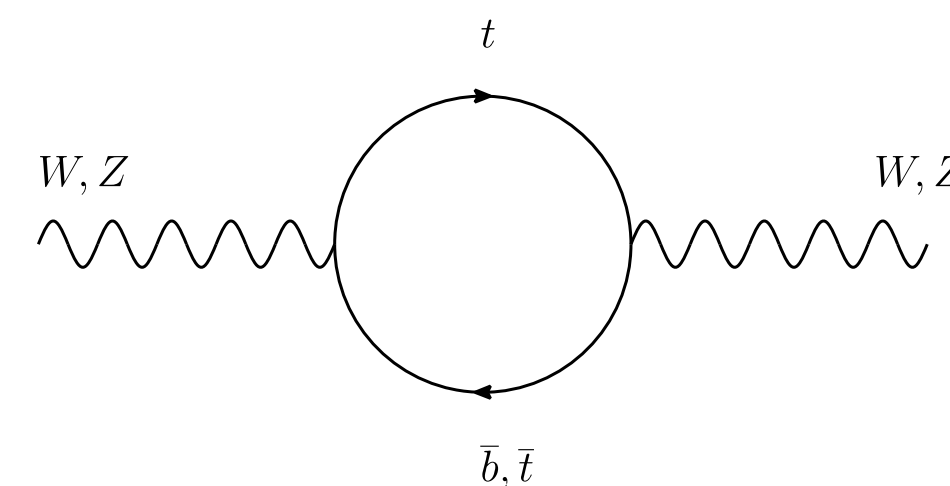

$$\propto m_t^2$$

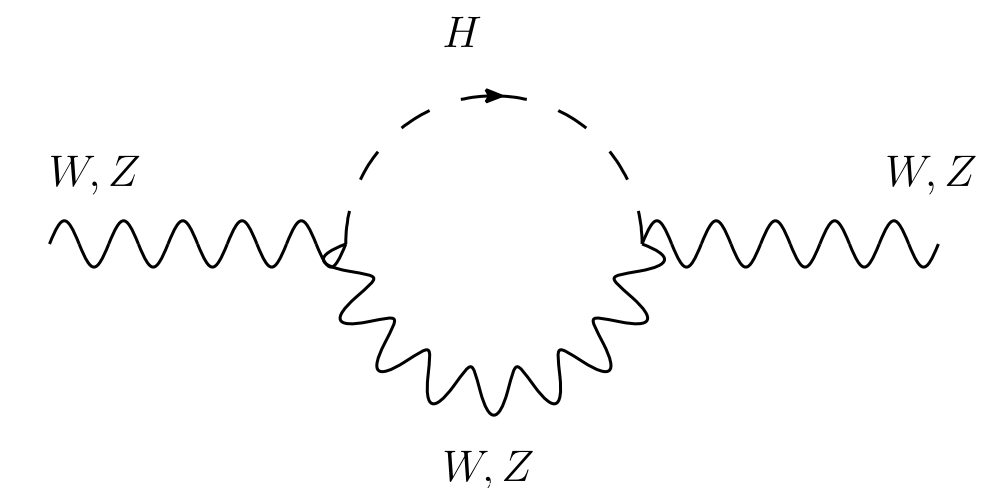

$$\propto \log \frac{M_H}{M_Z}$$

# Global Fit of the Standard Model

A global fit of all relevant measurements can be then done to check the consistency of the Standard Model and predict parameters that are unknown: [Higgs boson mass!](#)

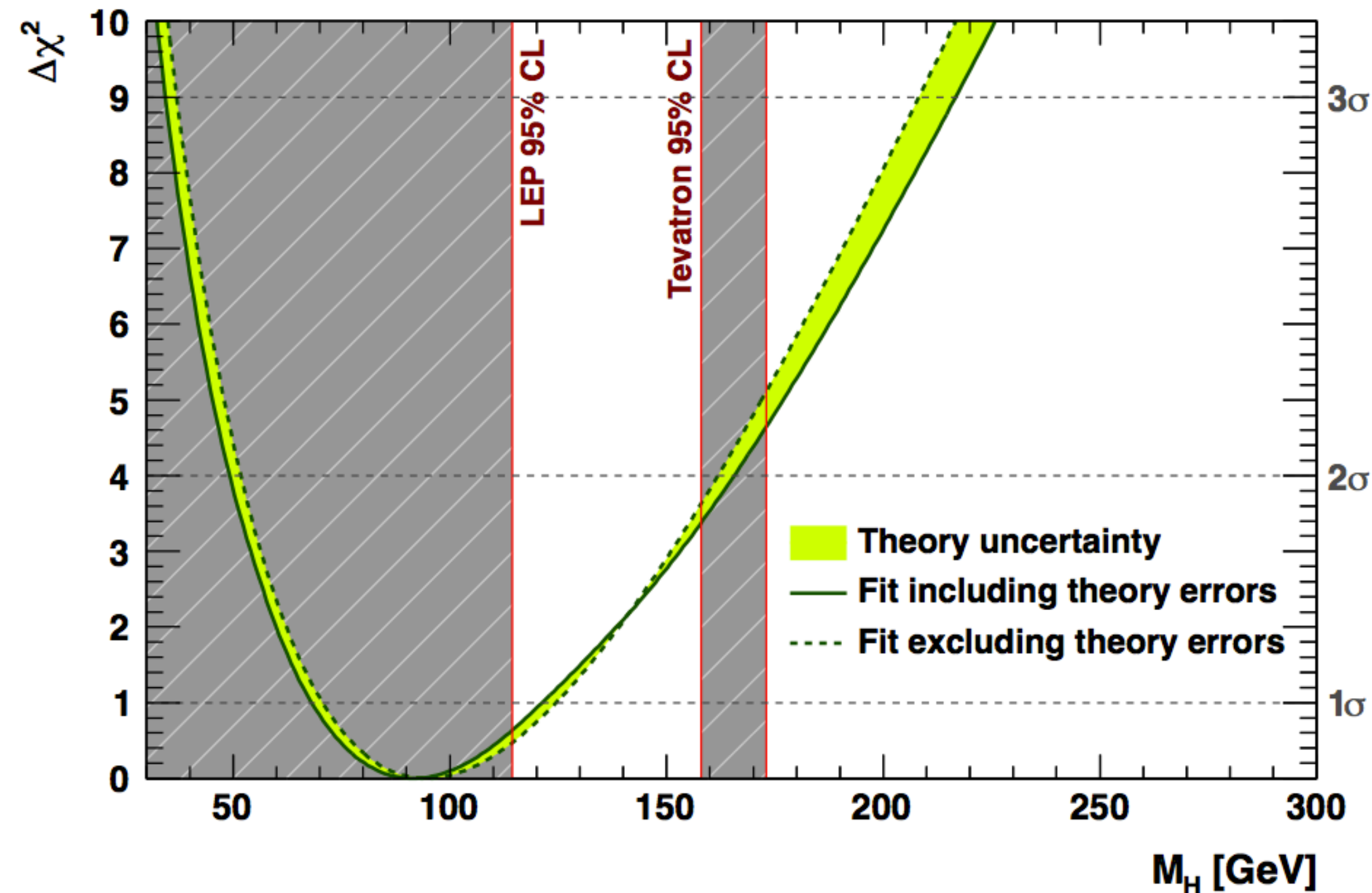

Indirect measurement of the Higgs boson mass through its quantum effect on the precision observables.

$$m_H = 91_{-23}^{+30} \text{ GeV}$$

Before the discovery of the Higgs boson!

Tomorrow: **The Higgs!!**



# Exercises

## Exercise

The b, c and leptonic asymmetries were measured at LEP and SLD (SLAC)

$\mathcal{A}_b = 0.923 \pm 0.020$	SLD	2.2 %
$\mathcal{A}_c = 0.670 \pm 0.027$	SLD	3.9 %
$\mathcal{A}_\tau = 0.1439 \pm 0.0043$	LEP	3.0 %
$\mathcal{A}_e = 0.1498 \pm 0.0049$	LEP	3.3 %
$\mathcal{A}_l = 0.1513 \pm 0.0021$	SLD	1.4 %

Compute a rough prediction of these asymmetries.

# Further Reading

# Top Pair Production at 5.02 TeV

## Top pair production cross section measurement at 5.02 TeV

New lepton-jets measurement and combination with earlier di-lepton channel in low PU runs at 5.02 TeV

Excellent precision reached with small dataset of 0.26 fb<sup>-1</sup>

$$\sigma_{t\bar{t}} = 67.5 \pm 0.9 \text{ (stat.)} \pm 2.3 \text{ (syst.)} \pm 1.1 \text{ (lumi.)} \pm 0.2 \text{ (beam) pb}$$

In excellent agreement with the NNLO-NNLL TOP++ prediction

$$68.2 \pm 4.8^{+1.9}_{-2.3} \text{ pb}$$

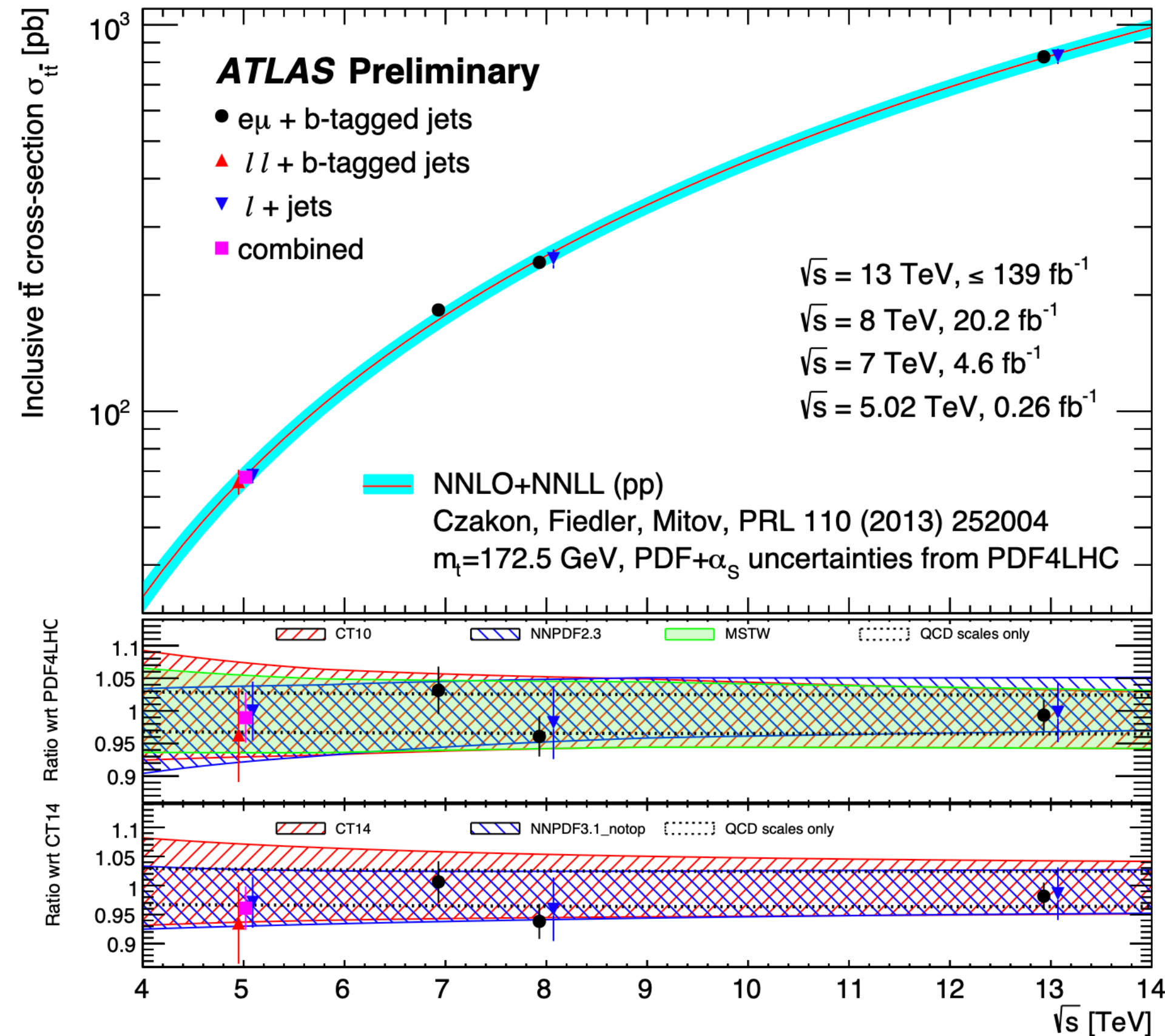

## Gluon PDF

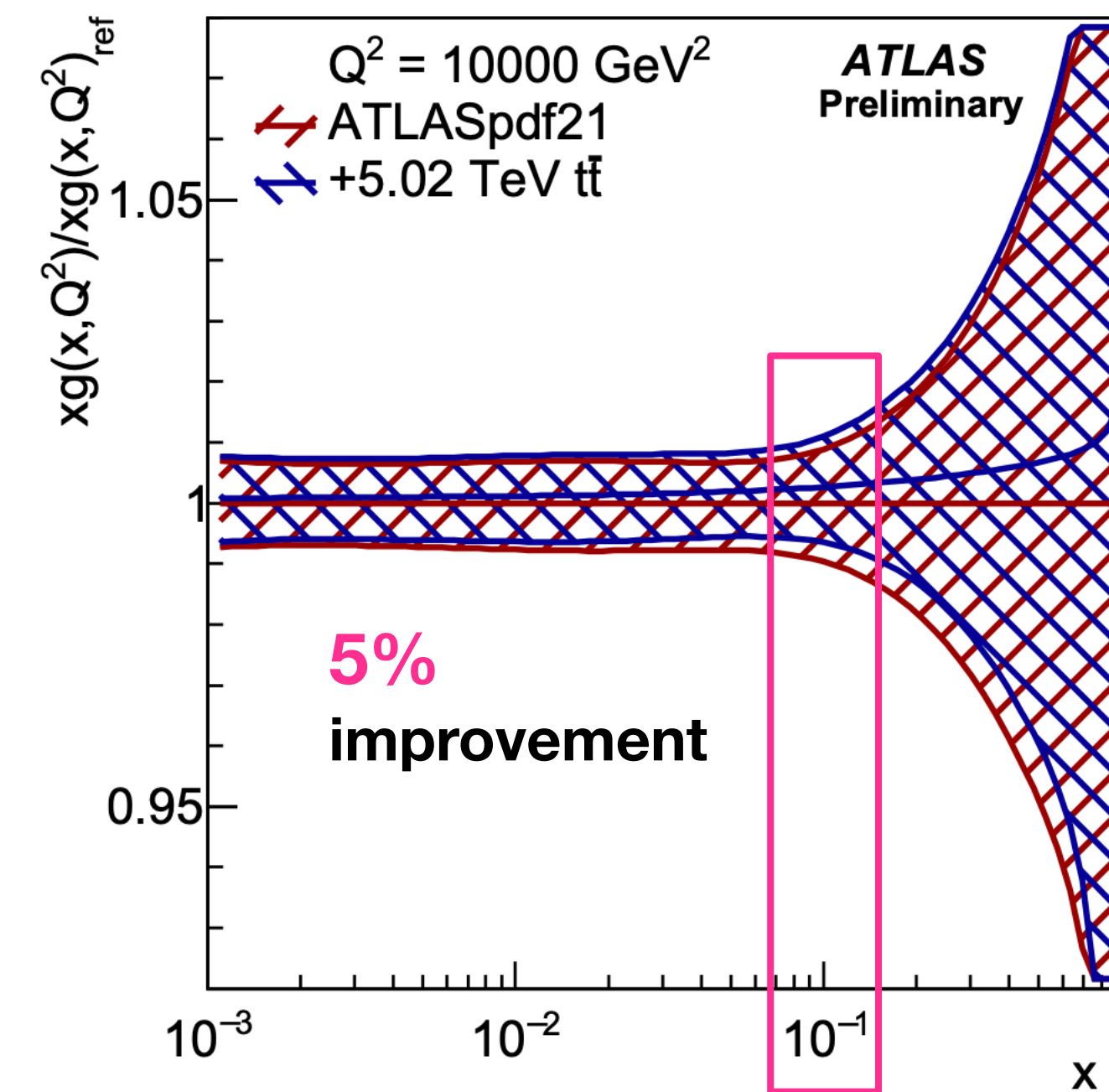

Important feedback to improve Higgs precision measurements

## ATLAS PDF fit

Using exclusively HERA ep data and ATLAS with the addition of W, Z (+jets), tt, jets, photon differential cross section measurements (fit done at NNLO in QCD, NLO in EW)

### Light sea-quark contributions

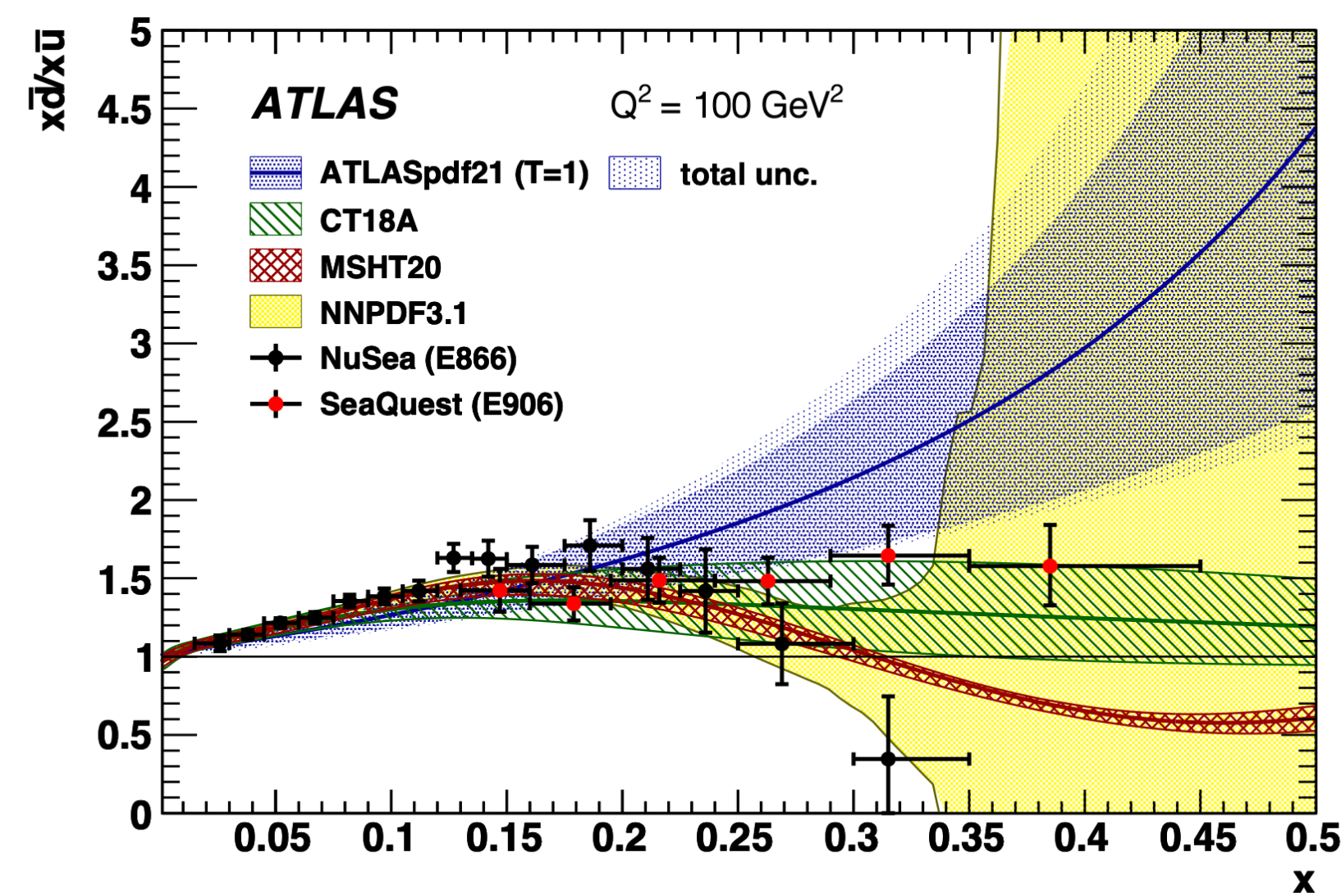
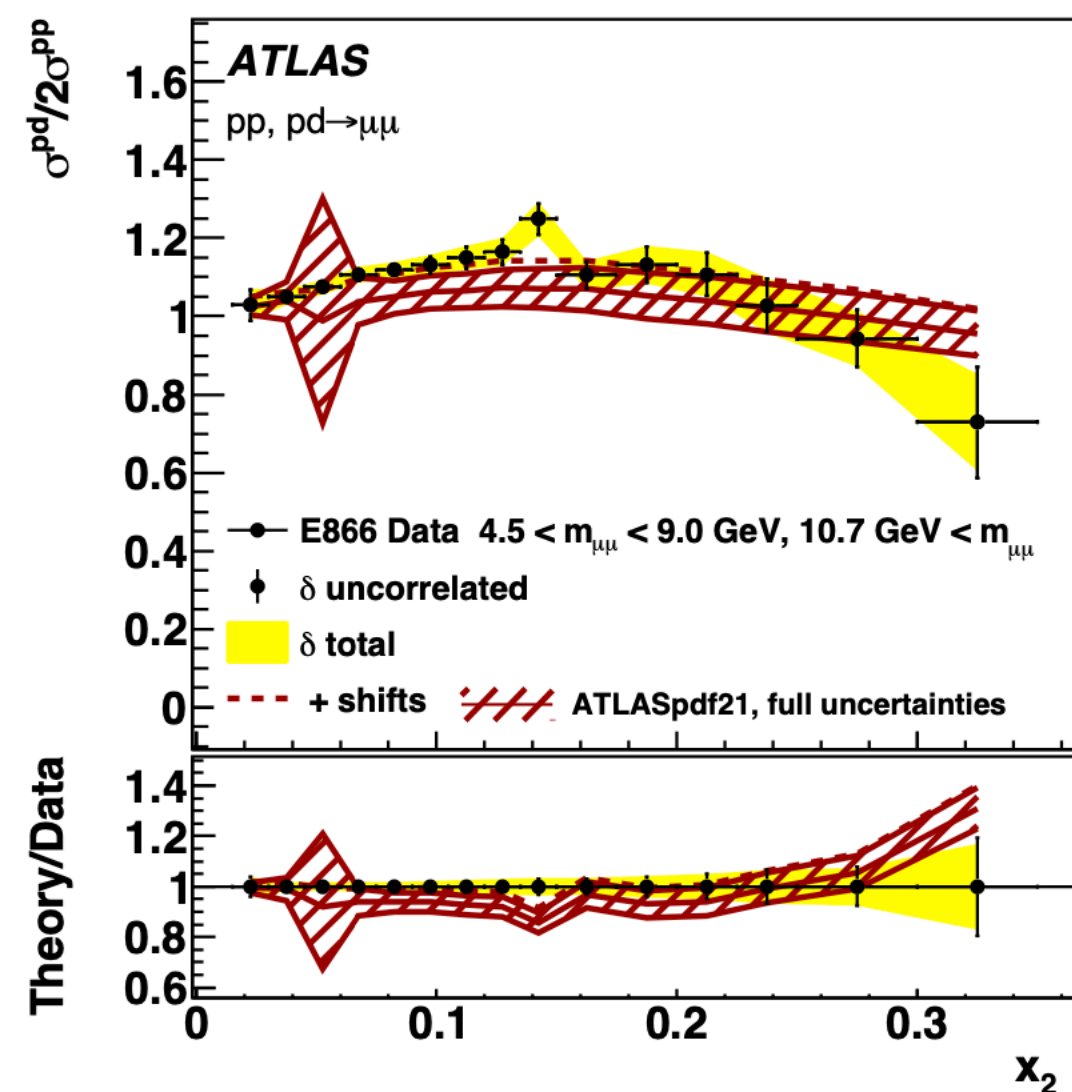

### Strange quark composition

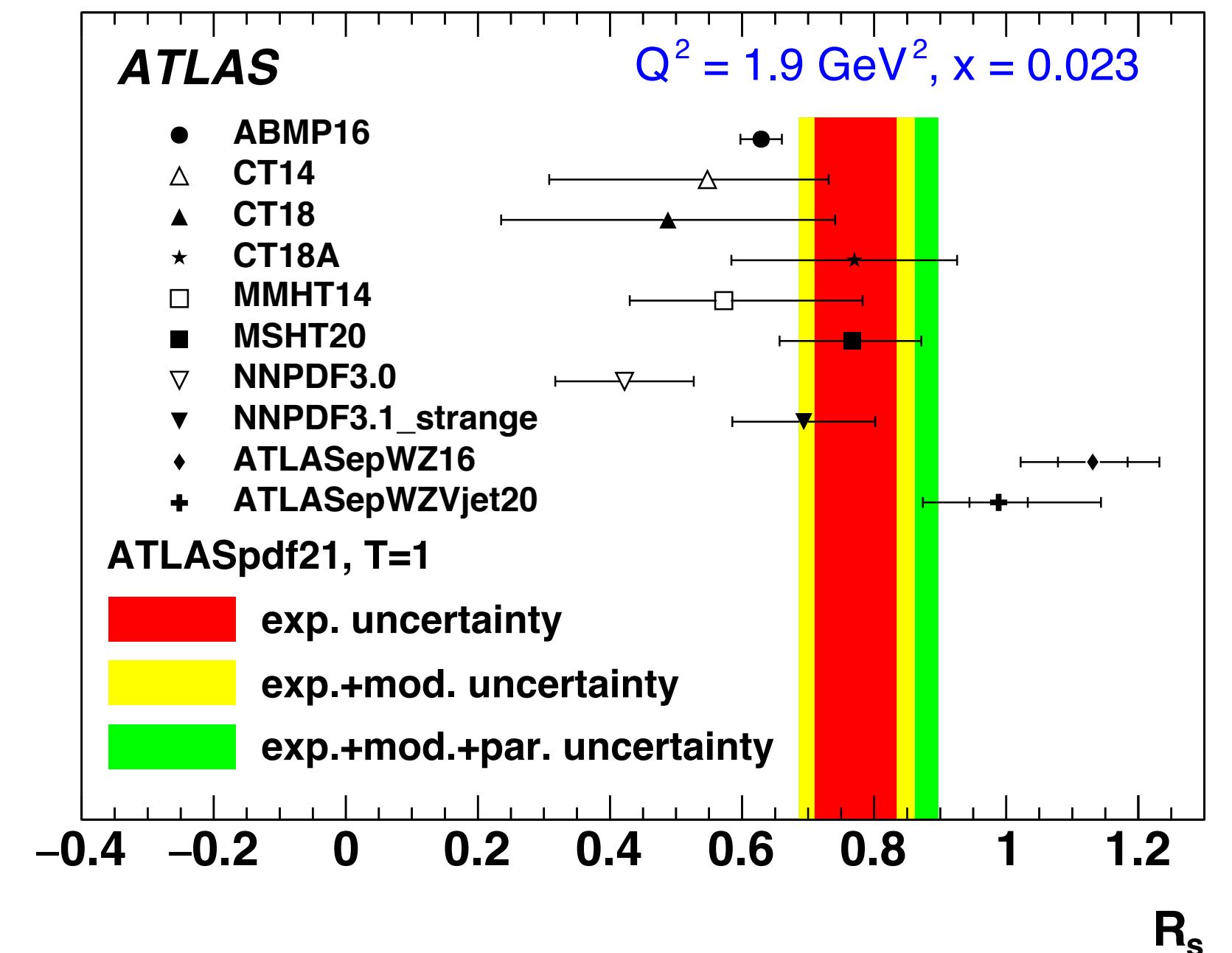

ATLAS data can be used to predict pD fixed target DY cross sections

Check relative densities of  $\bar{u}$  and  $\bar{d}$  sea contributions compatible with recent SeaQuest data E906 (at high x) than with NuSea (E866)

Improvement w.r.t. previous ATLAS PDFs

V+jets data suppresses  $R_s$  at high x (with effect on low x), as well as improved low-x parametrisation

# Top Physics

## Top quark polarisation in single top production

V-A coupling induces polarised production of single top quarks:

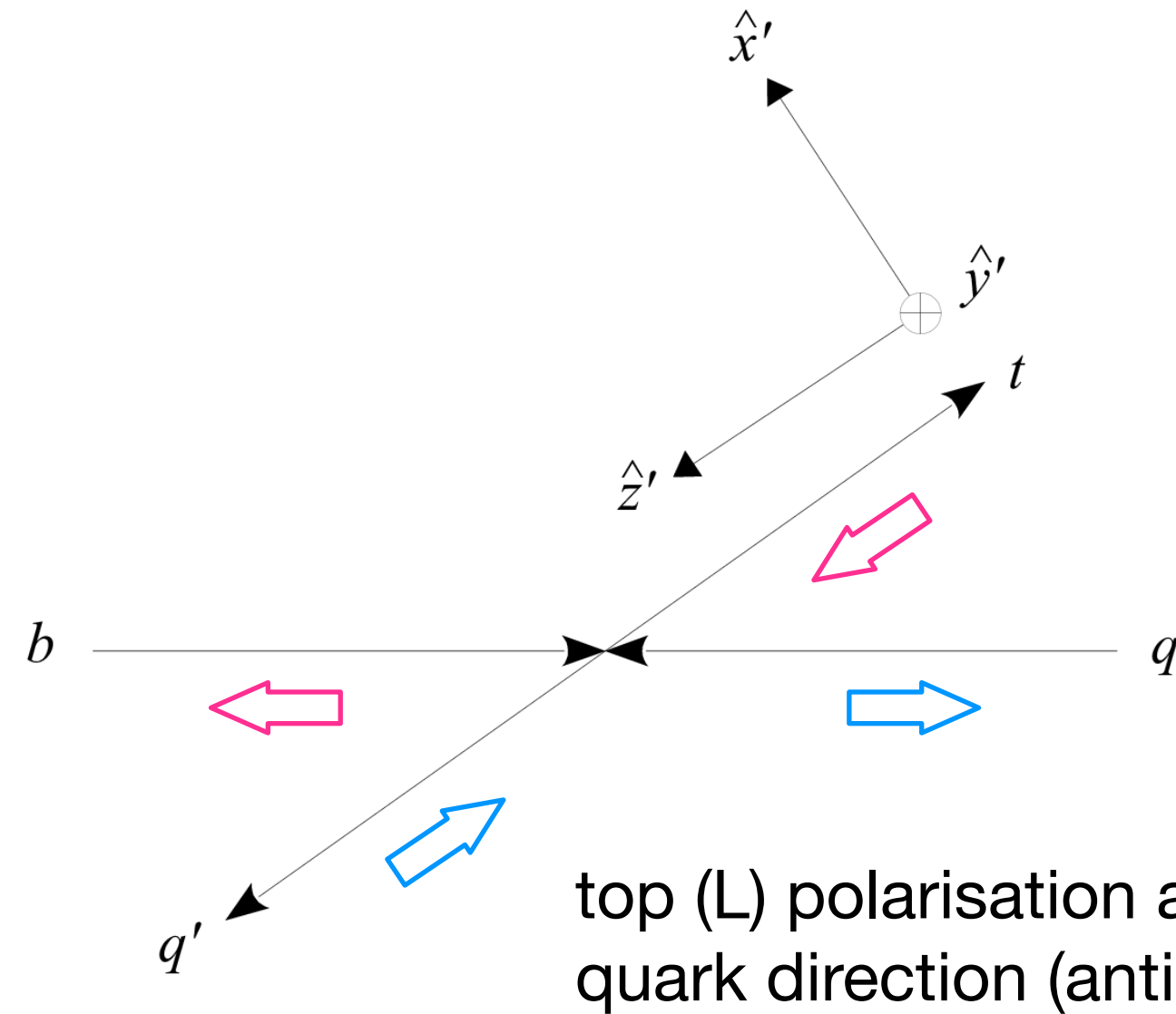
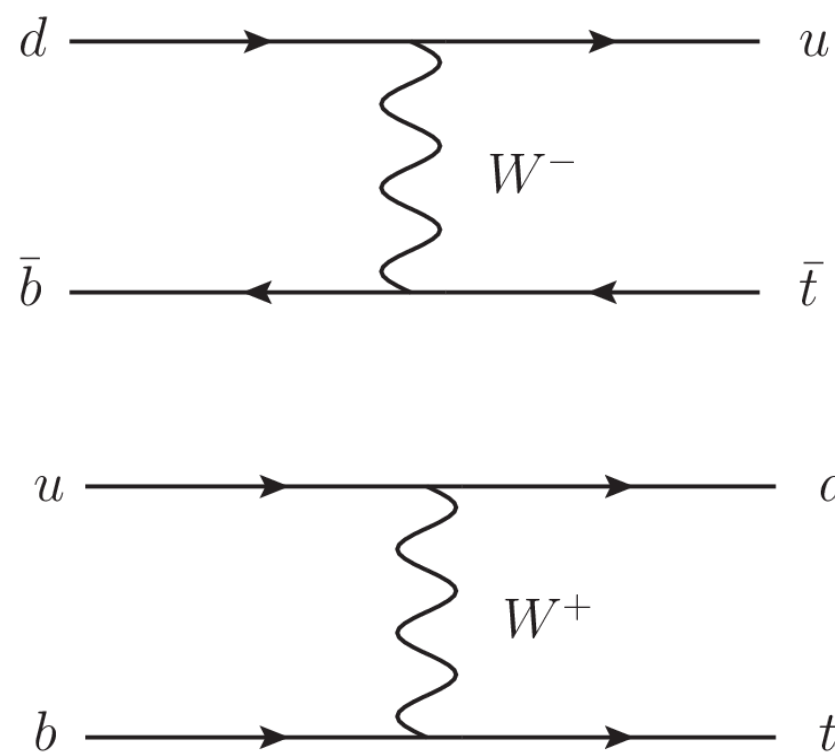

**Use semi-leptonic top decays!**

Definition of a 3D discriminant based on the octant in which the lepton is produced!

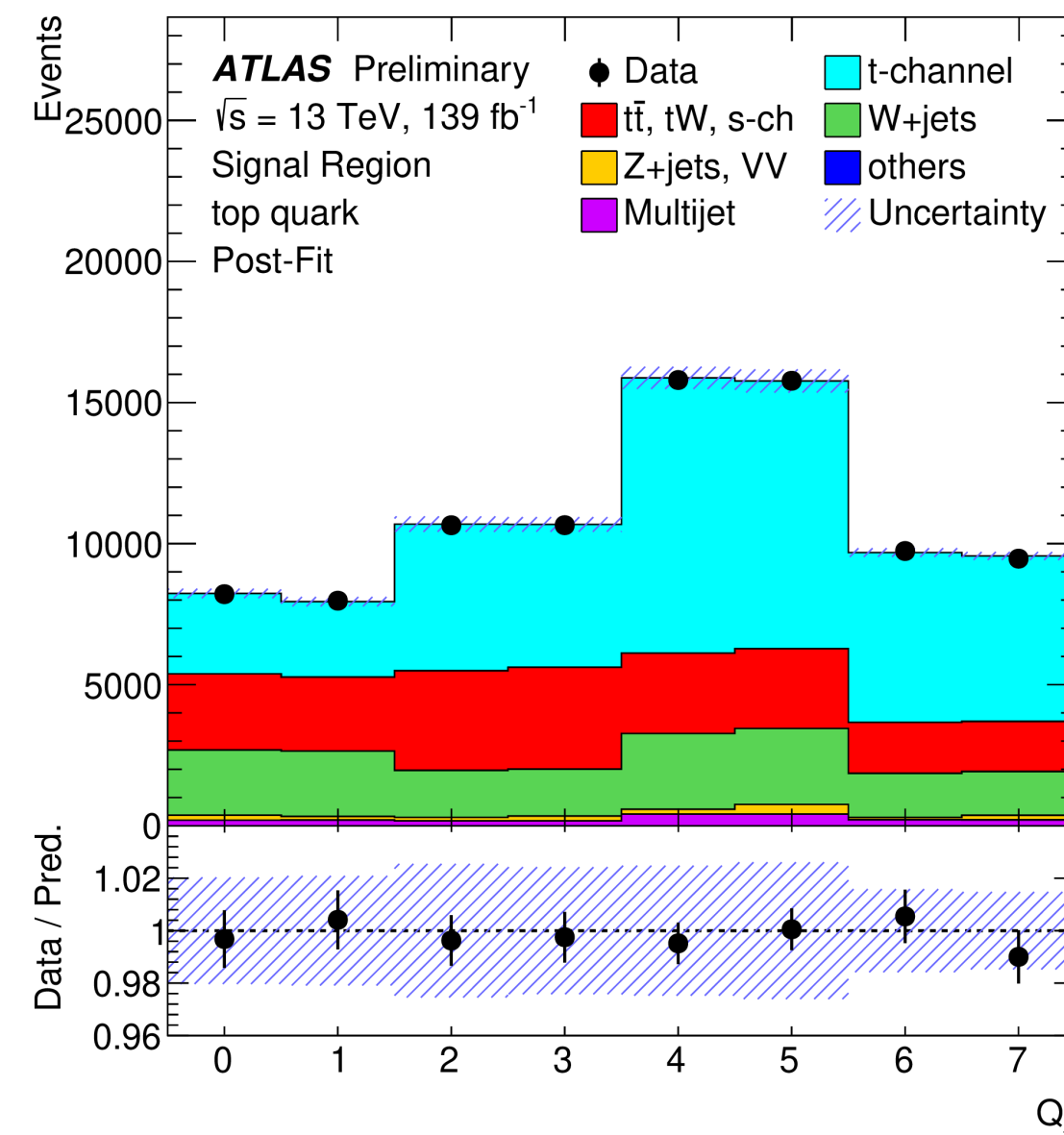
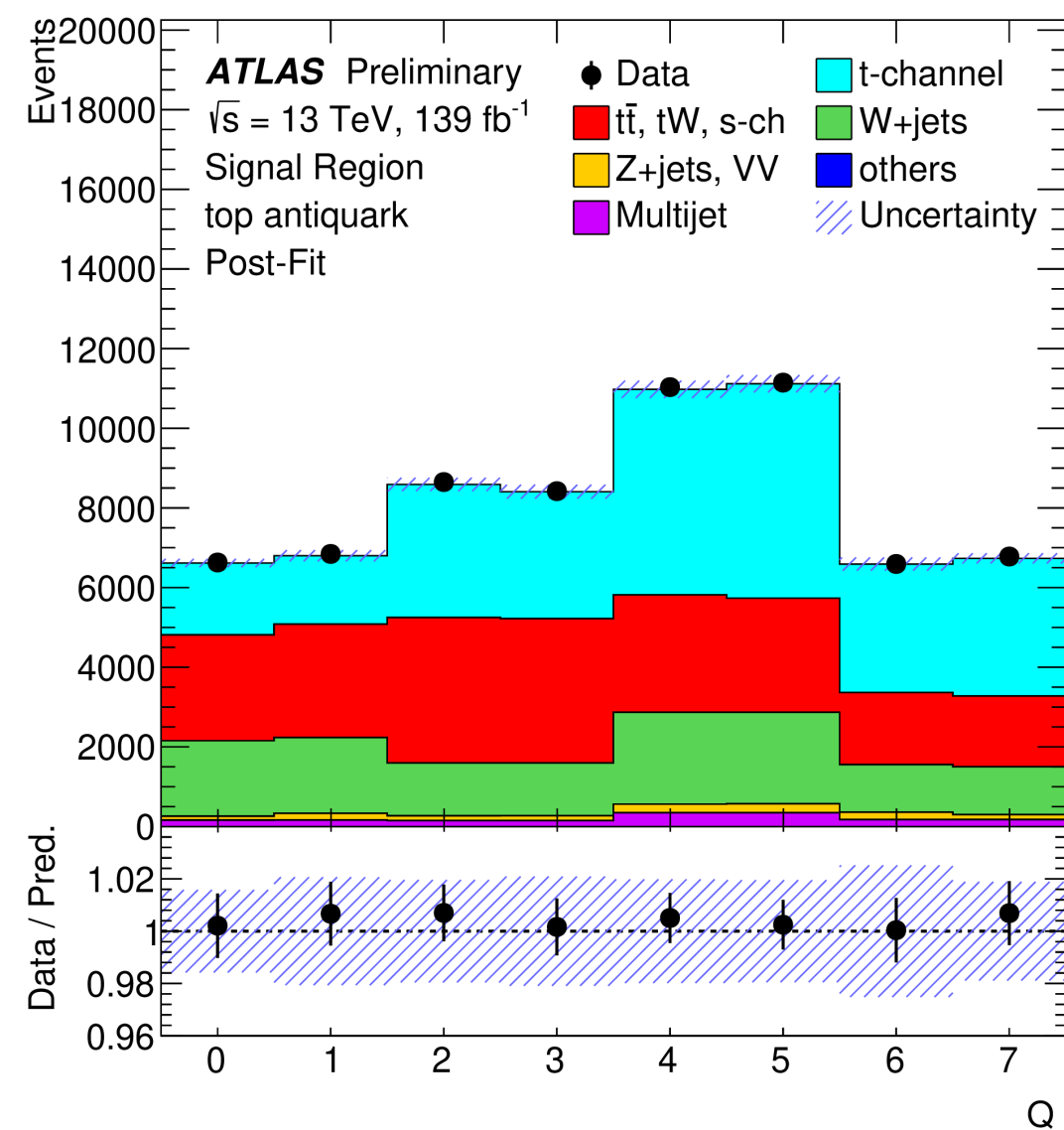
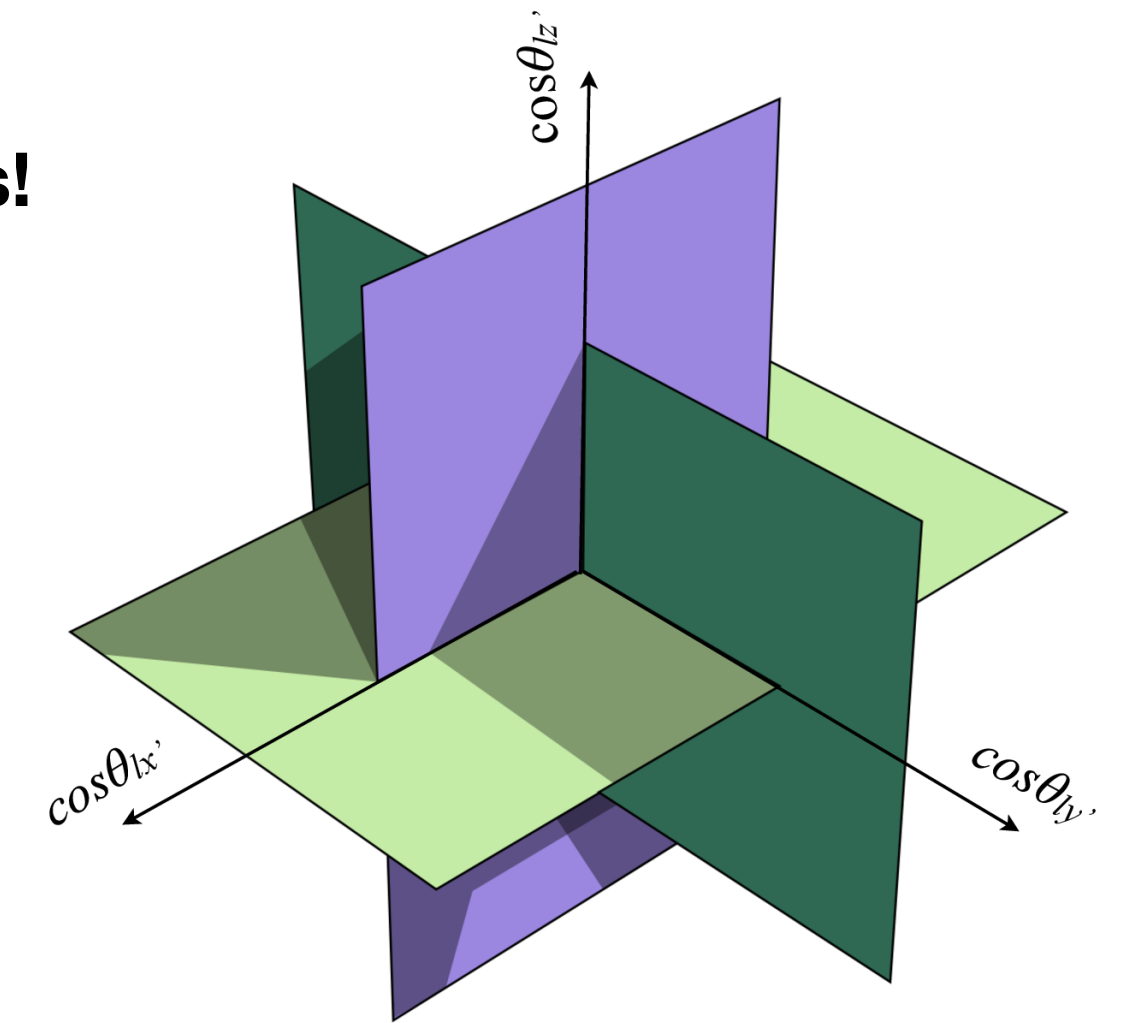

Fit to the polarisations  $P_x$ ,  $P_y$ ,  $P_z$  done using a parametrisation of this octant variable.

$P_y$  is sensitive to CP violating effects

$P_x$  is sensitive to NLO QCD effects

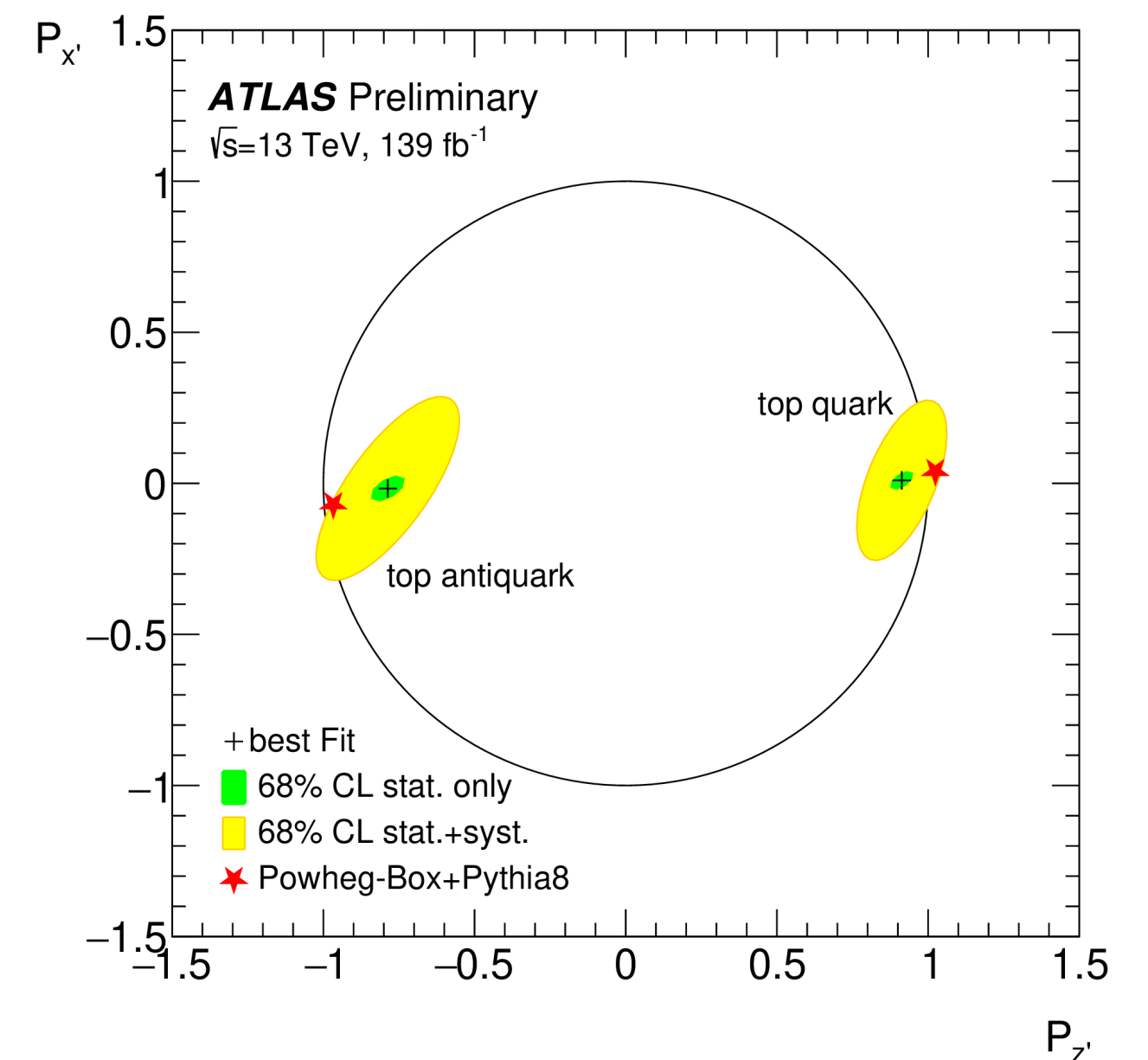

# Top Physics

## Top quark polarisation in single top production

47

Differential cross sections in  $\cos \theta_{\ell x}$  and  $\cos \theta_{\ell y}$  unfolded to particle level are also measured.

EFT Wilson coefficients for anomalous Dim. 6 tW coupling CP conserving and CP violating are fit simultaneously to the unfolded differential cross section measurements.

