

Basics of RF superconductivity

Walter Venturini Delsolaro
CERN

Lectures for the CERN summer students,
20-21 July 2022

Minimal introduction

- These lectures are about Superconducting RF cavities, their physics and technology.
- We are interested in these devices because they are an essential element of particle accelerators: they provide the energy for the acceleration

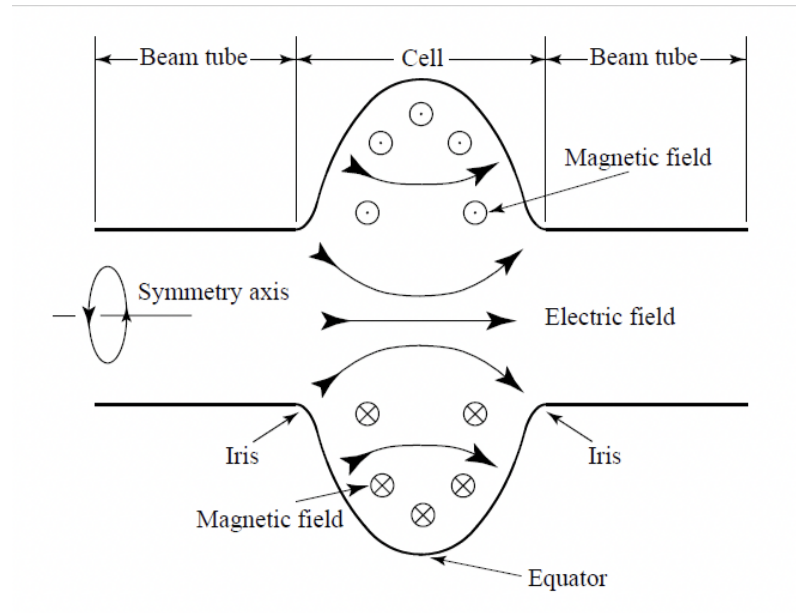

- A static voltage can be used for acceleration, but this is limited to a few MV by the breakdown of dielectrics (including high vacuum)
- RF acceleration allows to overcome this limit
- The use of superconductors as cavity material reduces power consumption, makes possible reaching higher voltages (energies), and to minimize unwanted interactions of cavities with beams

Outline - part 1

- **Basics of RF Superconductivity**
 - Kirchhoff's breakdown, transmission lines, resonators, accelerating cavities
 - Figures of merit, skin effect, surface impedance
- **Basics of RF SuperConductivity**
 - Drude model, mean free path, anomalous skin effect
- **Basics of RF Superconductivity**
 - Phenomenology
 - Theories of superconductivity
 - Surface impedance of superconductors
 - Residual resistance
 - Critical fields

Outline- part 2

- Superconducting cavity technologies
 - RF acceleration vs particle velocity
 - cavity design
 - SRF materials: Pb, bulk Nb, Nb₃Sn, Nb/Cu
 - RF surface engineering: chemical polishing, EP, baking, N-doping, multilayers
 - Cavity testing
 - Cavity performance: accelerating fields, cryogenics losses, detuning effects
 - Classical cavity limitations: Global thermal instability, Q disease, multipacting, field emission
 - Field dependent surface resistance

Acknowledgements

- A lot of excellent introductory material can be found on line in the tutorials of the SRF workshop and in previous CERN training courses.
- Big thanks to S. Belomestnykh, G. Ciovati, E. Jensen, A. Myasaki, R. Vaglio

Outline - part 1

- **Basics of RF Superconductivity**
 - Kirchhoff's breakdown, transmission lines, resonators, accelerating cavities
 - Figures of merit, surface impedance
- Basics of RF SuperConductivity
 - Drude Model, mean free path, Skin effect, Anomalous skin effect
- Basics of RF Superconductivity
 - Phenomenology
 - Theories of superconductivity
 - Surface impedance of superconductors
 - Residual resistance
 - Critical fields

RLC circuit, amplitude and phase responses

$$Ri + L \frac{di}{dt} + \frac{1}{C} \int idt = v(t)$$

$$v(t) = \text{Re}\{V e^{j\omega t}\}$$

$$i(t) = \text{Re}\{I e^{j\omega t}\}$$

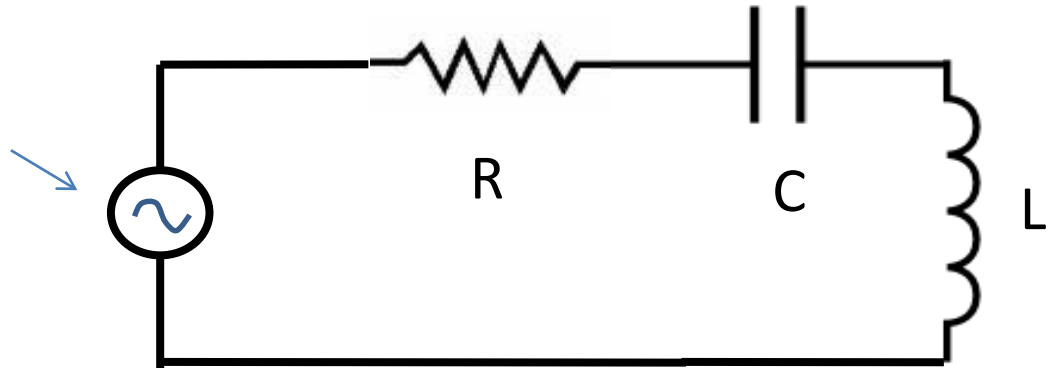

$$\text{Complex impedance} \rightarrow Z = \frac{V}{I} = R + j\omega L + \frac{1}{j\omega C}$$

$$\text{Complex power} \rightarrow P = \frac{1}{2} V I^* = \frac{1}{2} Z |I|^2 = \frac{1}{2} Z \left| \frac{V}{Z} \right|^2$$

When

$$|Z|^2 = 2R^2$$

$$\omega - \omega_0 = \Delta\omega \quad \rightarrow \quad \omega^2 - \omega_0^2 \sim 2\omega\Delta\omega$$

$$Q = \frac{\omega_0 L}{R} \quad \frac{\Delta\omega}{\omega_0} = \frac{BW}{2}$$

The average (real) power is half of that at resonance: this happens for

$$BW = \frac{1}{Q}$$

RLC circuit, amplitude and phase responses

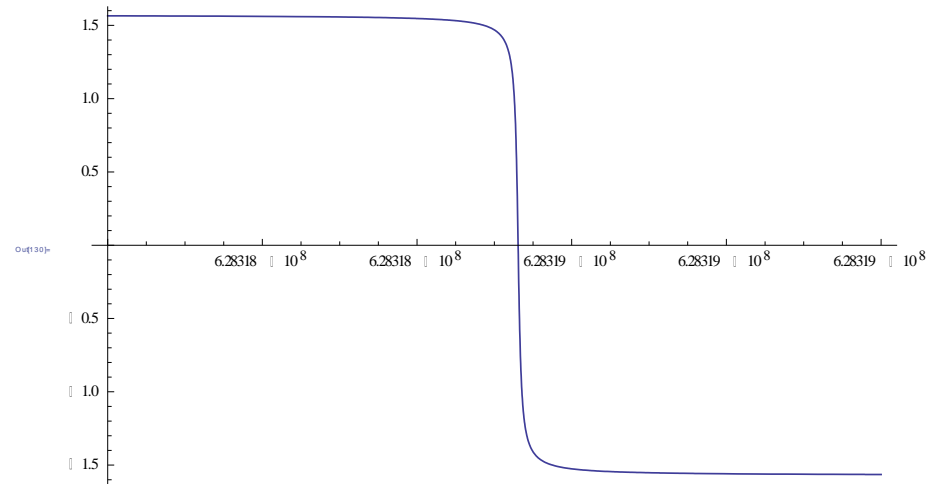
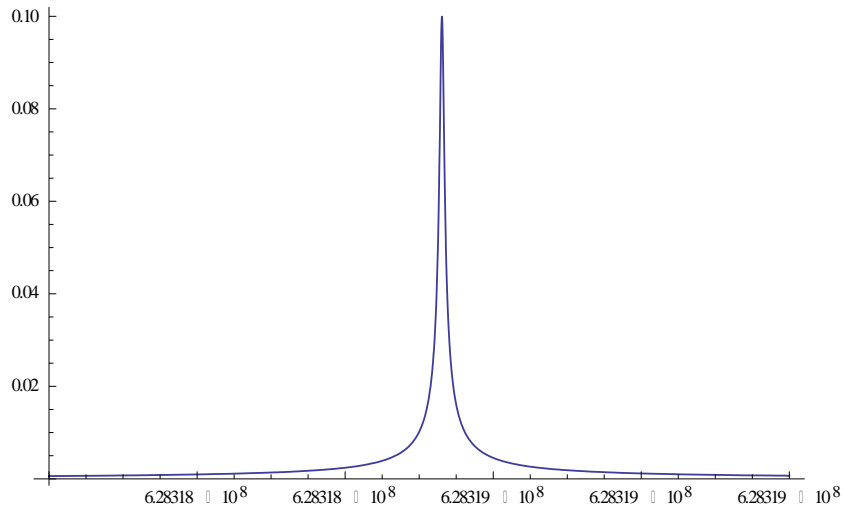
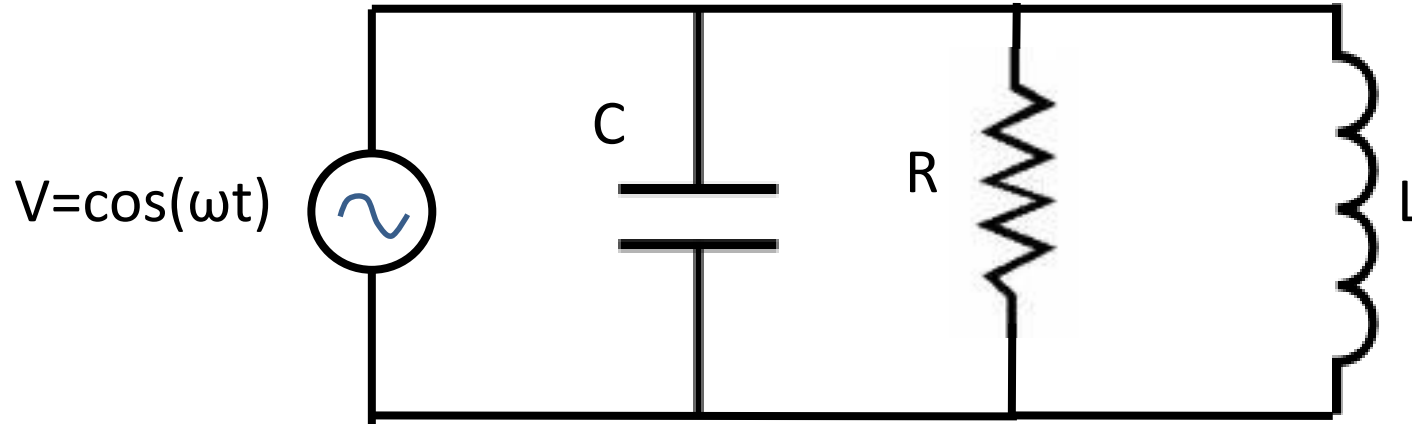

RF basics- transmission lines

- When increasing the frequency the physical dimensions of the circuits get larger than the wavelength of the e.m. fields: to model this situation one has to go from lumped elements circuits to distributed parameters circuits

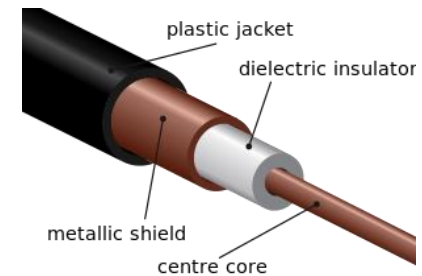
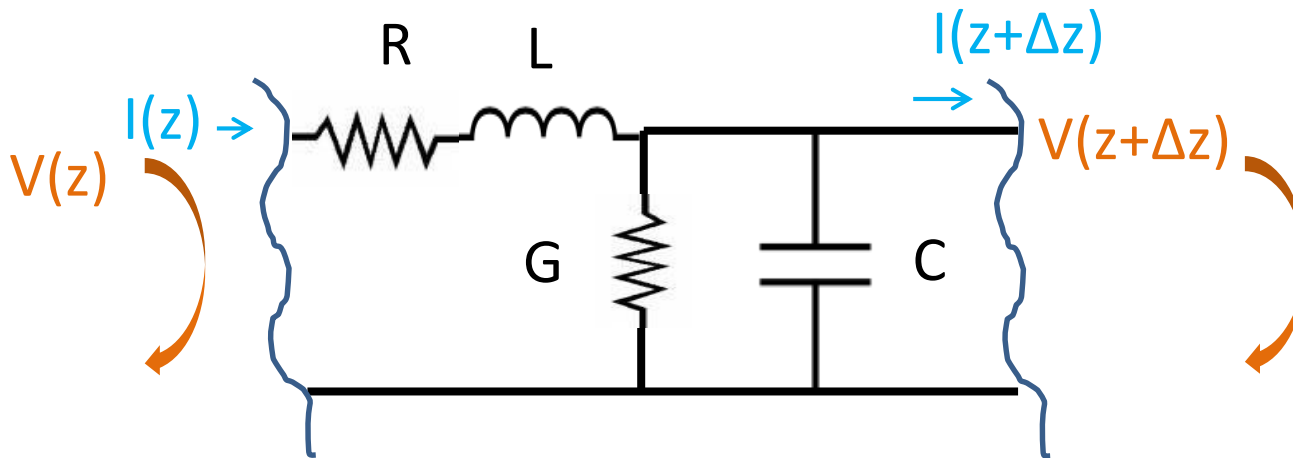

$$(R + j \omega L) I(z) \Delta z + V(z + \Delta z) = V(z)$$

$$I(z) - V(z + \Delta z) (G + j \omega C) = I(z + \Delta z)$$

$$-\frac{\partial V(z)}{\partial z} = (R + j \omega L) I(z)$$

→

$$-\frac{\partial I(z)}{\partial z} = (G + j \omega C) V(z)$$

Telegraph equations

$$\frac{\partial V(z, t)}{\partial z} = -L \frac{\partial I(z, t)}{\partial t} - RI(z, t)$$

$$\frac{\partial I(z, t)}{\partial z} = -C \frac{\partial V(z, t)}{\partial t} - GV(z, t)$$

For lossless lines (R and G=0)

$$\frac{\partial^2 V(z, t)}{\partial z^2} = -LC \frac{\partial^2 V(z, t)}{\partial t^2}$$

The same equation holds for the current:
travelling voltage and current waves

Propagation constant

Sinusoidal oscillations:

$$-\frac{\partial V(z)}{\partial z} = (R + j\omega L) I(z)$$

Differentiate the first equation and plug in the second:

$$\frac{d^2 V(z)}{dz^2} = k^2 V(z)$$
$$-\frac{\partial I(z)}{\partial z} = (G + j\omega C) V(z)$$

The same equation holds for the current.

Travelling voltage and current waves, forward and backward : V^+ , V^- , I^+ , I^-
 γ is the complex propagation constant

$$\gamma = \sqrt{(R + j\omega L)(G + j\omega C)} = \alpha + j\beta$$

Transmission lines: Standing waves

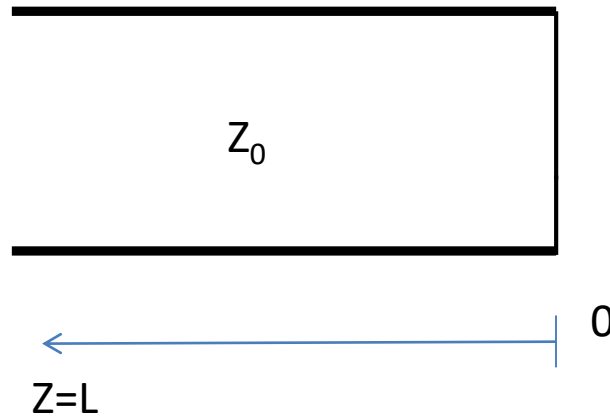

$$\Gamma = -1 \quad Z_0 = \frac{V^+}{I^+}$$

$$\Gamma = \frac{Z_L - Z_0}{Z_L + Z_0}$$

$$V(z) = V^+(e^{-kz} + \Gamma_0 e^{+kz}) = V^+(e^{-kz} - e^{+kz})$$

Case of lossless line, $k=j\omega/v$
Change $z \rightarrow -z$; $\omega/v = \beta = 2\pi/\lambda$

$$V(z) = V^+(e^{+j\beta z} - e^{-j\beta z}) \quad \dots \text{use Euler's identity}$$

$$V(z) = 2jV^+ \sin(\beta z) \quad \dots \text{go back to real:} \quad v(z, t) = \text{Re}\{V(z)e^{j\omega t}\}$$

$$v(z, t) = \{2jV^+ \sin(\beta z)e^{j\omega t}\} = \text{Re}\left\{2V^+ \sin(\beta z)e^{j\omega t} e^{j\frac{\pi}{2}}\right\} = 2V^+ \sin(\beta z) \cos(\omega t + \frac{\pi}{2})$$

Standing wave: time and space are decoupled, no propagation

Standing waves, resonators

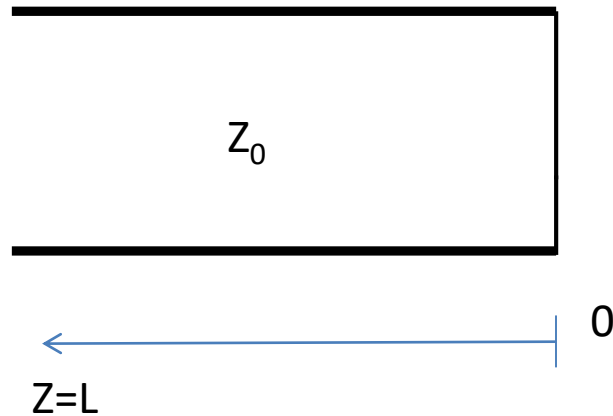

$$\Gamma = -1$$

$$v(z, t) = 2V^+ \sin\left(\frac{2\pi}{\lambda} z\right) \cos\left(\omega t + \frac{\pi}{2}\right)$$

Can cut open the line at $z = n \frac{\pi}{2}$; (for $n=1$: half wave resonator)

Can also cut at $\lambda/4$ (quarter wave resonator)

Quarter Wave Resonator

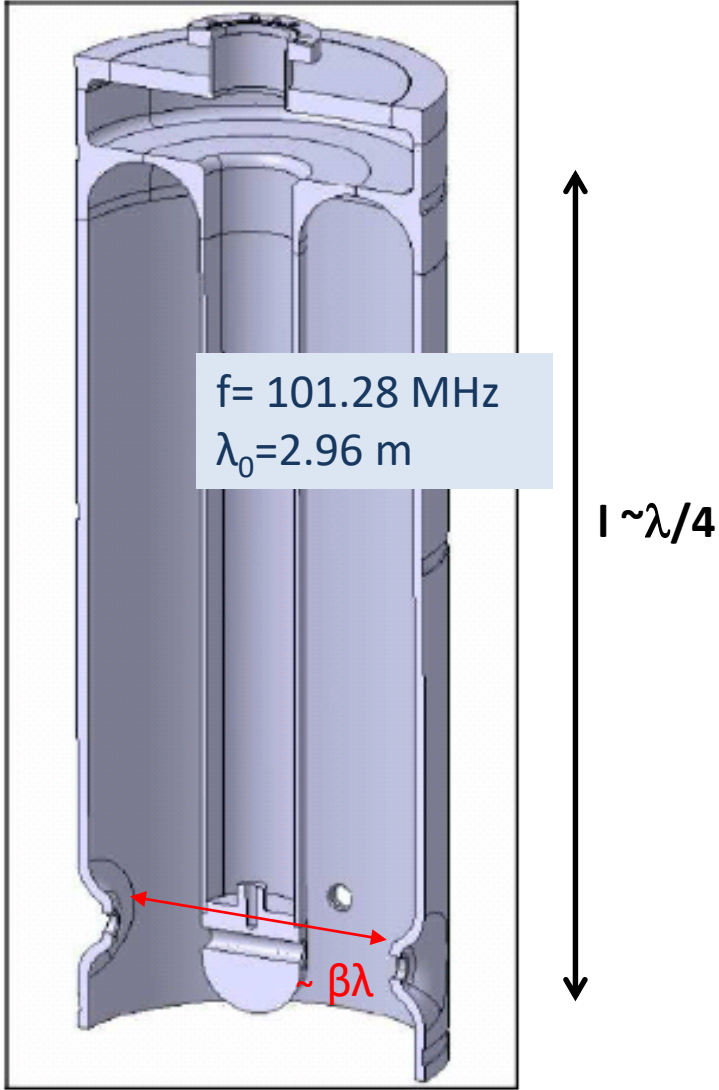
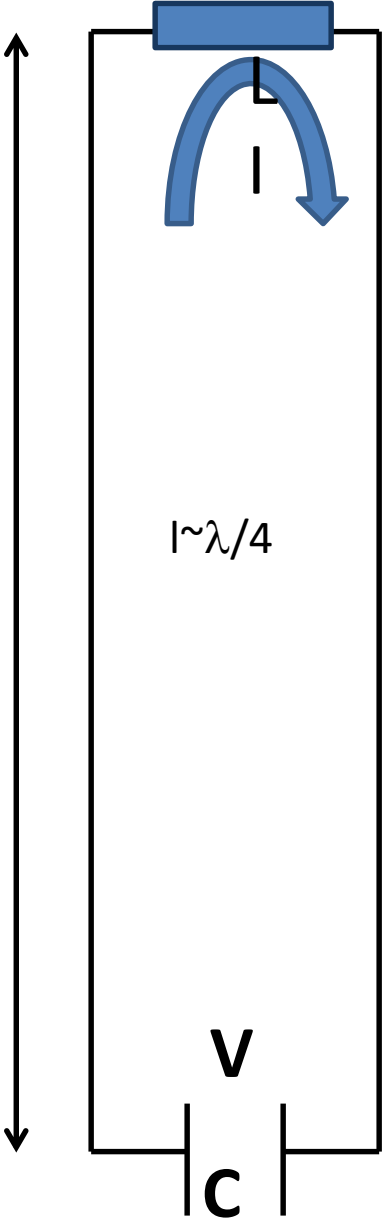
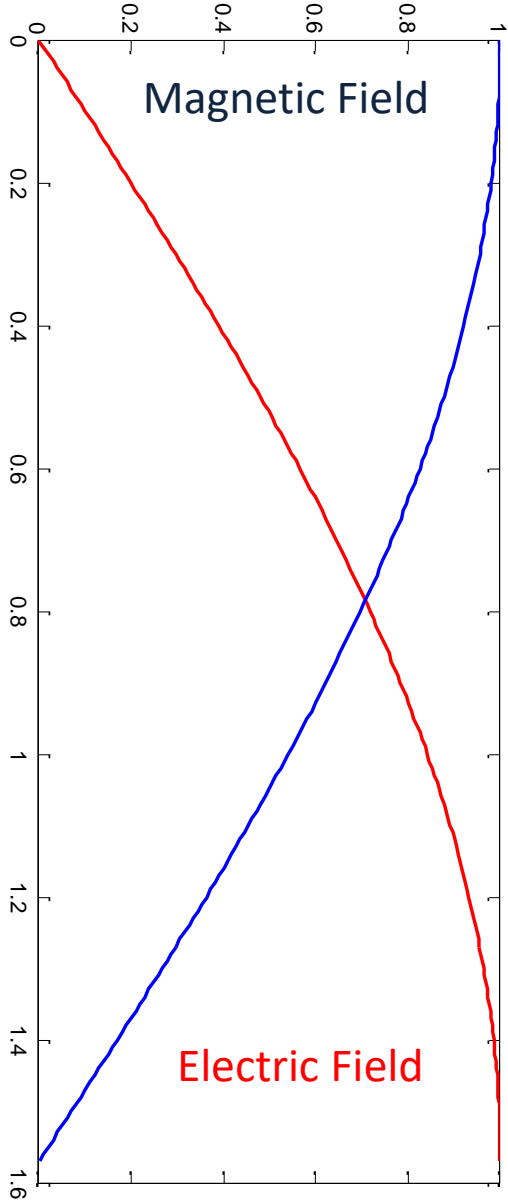

All that and much more, is in Maxwell equations

$$\bullet \left\{ \begin{array}{l} \nabla \cdot \mathbf{D} = \rho \\ \nabla \cdot \mathbf{B} = 0 \\ \nabla \times \mathbf{E} = -\frac{\partial \mathbf{B}}{\partial t} \\ \nabla \times \mathbf{H} = \mathbf{J} + \frac{\partial \mathbf{D}}{\partial t} \end{array} \right. + \left\{ \begin{array}{l} \mathbf{D} = \varepsilon \mathbf{E} \\ \mathbf{B} = \mu \mathbf{H} \\ \mathbf{J} = \sigma \mathbf{E} \\ \text{no free charge, time dependency: } e^{j\omega t} \end{array} \right.$$

$$\bullet \rightarrow \left\{ \begin{array}{l} \nabla \cdot \mathbf{D} = 0 \\ \nabla \cdot \mathbf{B} = 0 \\ \nabla \times \mathbf{E} = -j\omega\mu \mathbf{H} \\ \nabla \times \mathbf{H} = (\sigma + j\omega\varepsilon)\mathbf{E} \end{array} \right.$$

“one cannot escape the feeling that these mathematical formulas have an independent existence and an intelligence of their own, that they are wiser than we are, wiser even than their discoverers, that we get more out of them than was originally put in to them”

H. Hertz

Electromagnetic spectrum

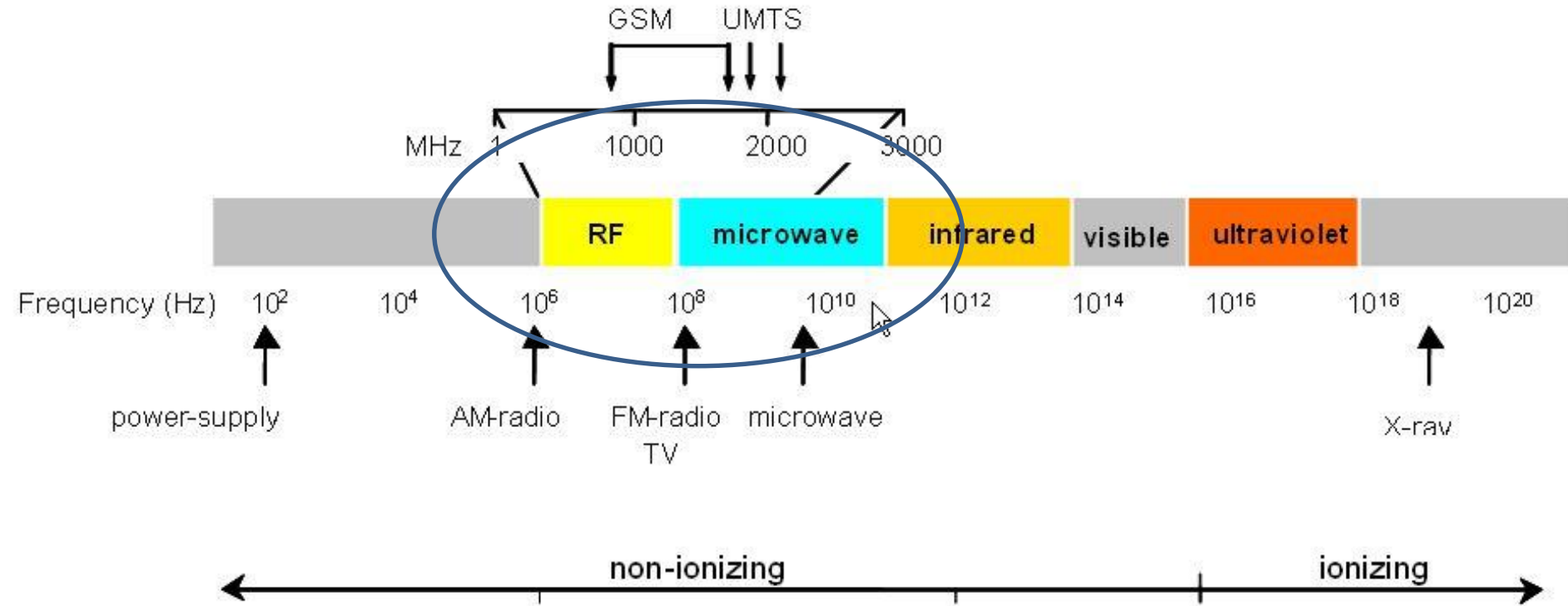

Pill box resonator

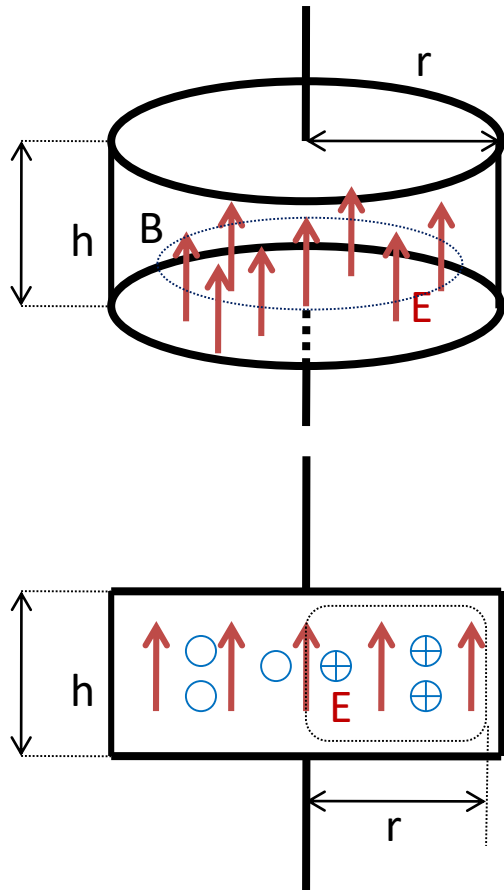

Field distribution TM_{010} mode:

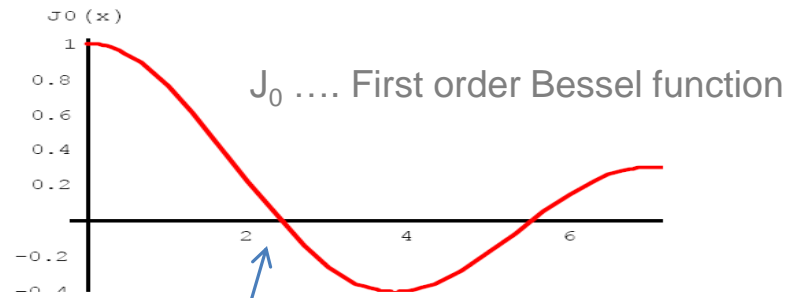

$$\frac{\omega_0 \cdot R}{c} = 2.405$$

Resonance-condition

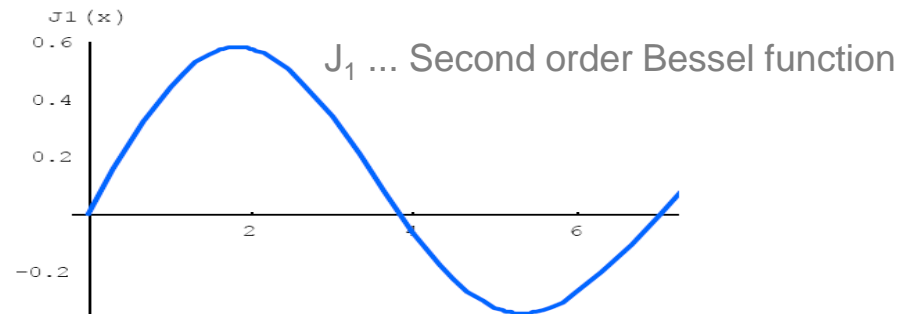

RF cavities

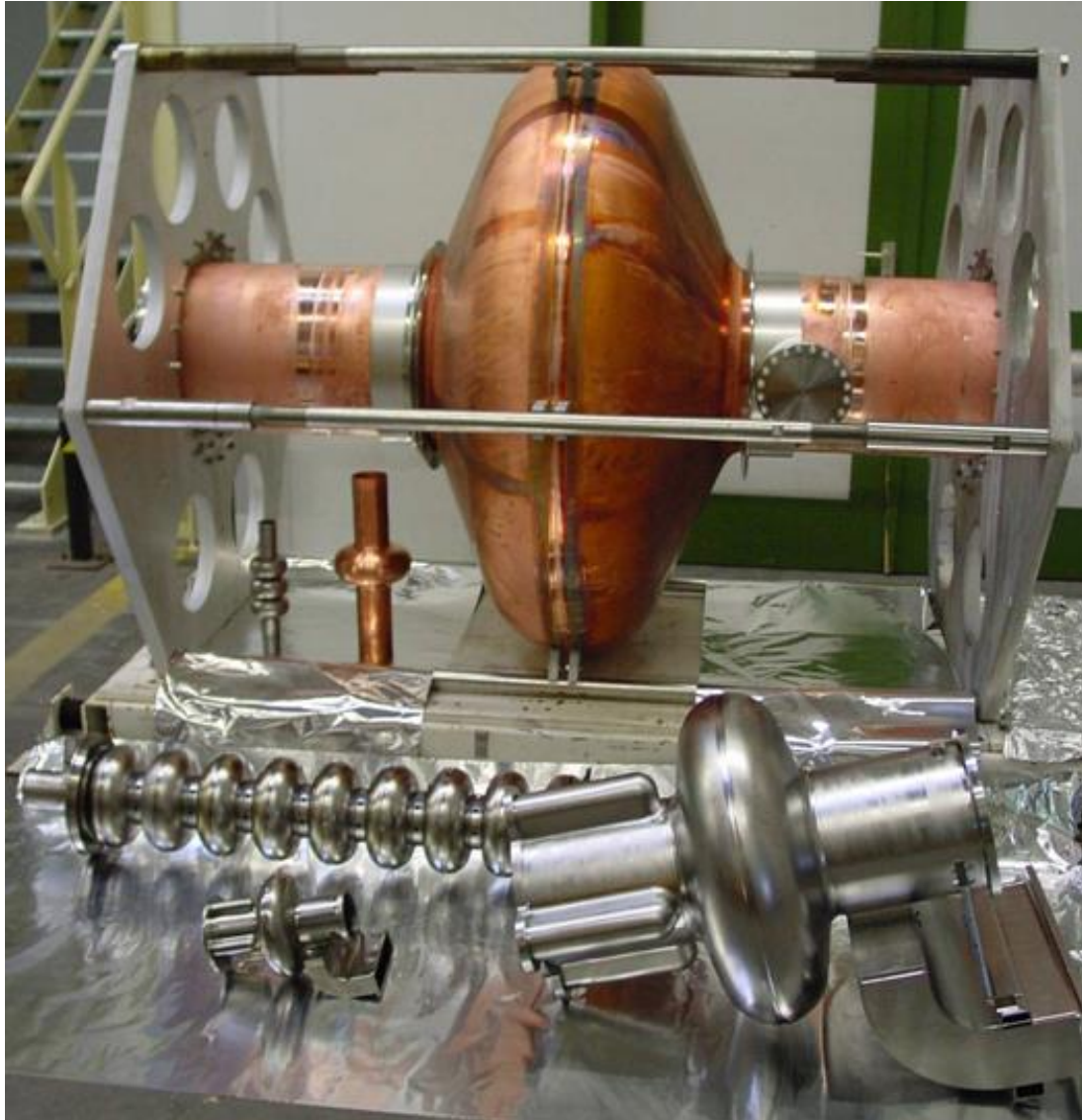

Quality factor

$$Q = \frac{2\pi (\text{Energy stored per cycle})}{\text{Energy dissipated per cycle}} = \frac{\omega (\text{maximum energy stored})}{\text{Power loss}}$$

Defined for every oscillator (also mechanical, optical, etc.)

$$-\frac{dU}{dt} = \text{power loss} = \frac{\omega U}{Q}$$

The time constant of the system is Q/ω

In the case of an RF cavity, the power loss is generated by dissipation of RF currents flowing on the cavity walls. This depends on the cavity geometry and on the **material properties**. The latter are the focus of this lecture.

The useful quantity is the accelerating field. We buy MV/m and pay them with Watts of dissipated power at the operational temperature (4.2 K or 1.8 K) → Carnot and refrigerator efficiencies have to be taken into account to get the socket power consumption

AC fields- skin effect

From Maxwell equations for harmonic fields, and Ohms law (locality: current only depends on the field at the same spot)

$$\mathbf{J} = \sigma \mathbf{E}$$

Derives the vector wave equation (Helmholtz's equation)

$$\nabla^2 \mathbf{E} = j \omega \mu (\sigma + j\omega\epsilon) \mathbf{E}$$

Neglect the displacement current (in metals $\sigma \gg \omega\epsilon$ practically always)

$$\begin{aligned} \nabla^2 \mathbf{E} &= j \omega \mu \sigma \mathbf{E} \\ \nabla^2 \mathbf{J} &= j \omega \mu \sigma \mathbf{J} \end{aligned}$$

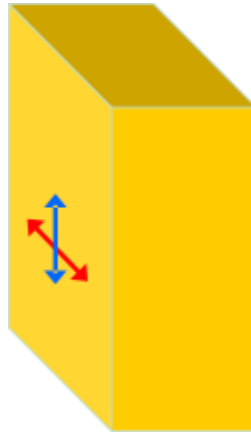

Consider a simple geometry with half space filled with a conductive material, field parallel to the interface (plane x,y), solutions are complex exponentials:

let $\gamma^2 = j \omega \mu \sigma$, then $J_x = A e^{-j \gamma z} + B e^{j \gamma z}$

One of the constants must be zero to ensure the correct behavior at infinity

Let $\delta = \sqrt{\frac{2}{\omega \mu \sigma}}$, we have $\gamma = \frac{(1+j)}{\delta}$, and $J_x = J_0 e^{\frac{(j-1)}{\delta} z}$ the solution is an exponentially damped oscillation: the current density amplitude is reduced to 37% at the depth δ

AC fields- surface impedance

Let us compute the total current flowing *per unit width*

$$I_w = \int_0^{\infty} J_x dz = \int_0^{\infty} J_0 e^{\frac{-(1+j)z}{\delta}} dz = \frac{J_0 \delta}{1+j} = \frac{\sigma E_0 \delta}{1+j}$$

We define the **surface impedance** as:

$$Z_s = \frac{E_0}{I_w} = \frac{1+j}{\sigma \delta} = R_s + jX_s$$

In normal metals surface resistance and reactance are equal.

Power loss density... $P = \frac{1}{2} R_s \mathbf{H}^2$ (W/m²)

Use this to factor out a geometry term in $Q = \frac{\omega_0 \mu_0 \iiint H^2 dv}{R_s \iint H^2 ds} = \frac{\Gamma}{R_s}$

Outline - part 1

- Basics of RF Superconductivity
 - Kirchhoff's breakdown, transmission lines, resonators, accelerating cavities
- **Basics of RF SuperConductivity**
 - Drude Model, mean free path, Skin effect, Anomalous skin effect
- Basics of RF Superconductivity
 - Phenomenology
 - Theories of superconductivity
 - Surface impedance of superconductors
 - Residual resistance
 - Critical fields



Paul Drude
1863 – 1906

The transport of charge through a metal

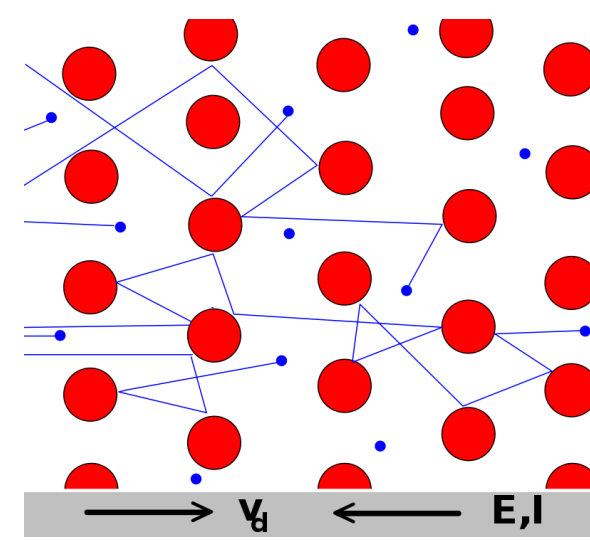

- Drude Model (1900):
 - Free and independent electrons
 - Elastic scattering events
- Equation of motion (Newton's law) with drag force:
- $\frac{dp}{dt} = eE - p/\tau.$
- In steady state
 $v = \frac{e}{m} \tau E$, which is ...
- ... Ohm's law: $j_n = nev = \frac{e^2 \tau n}{m} E = \sigma E$
with $\sigma_{DC} = \frac{e^2 \tau n}{m}.$
- Typical scattering time in metals at room temperature $\tau \approx 10^{-14} \text{s}$
- Oversimplified, purely classical model. Underestimating electron velocity but overestimating number of "active" electrons led to a fortuitous agreement with Widemann-Franz law. Followed by many refinements. Modern solid state physics describes electrons in metals as Fermi liquids making use of quantum many body formalism.

AC conductivity

- the equation $\frac{dp}{dt} = eE - \frac{p}{\tau}$ can be solved for a time-varying field $E = \Re\{\hat{E} e^{j\omega t}\}$.
- Assume $p(t)$ to be of the same time-dependence as RHS: $p(t) = \Re\{\hat{p}e^{j\omega t}\}e^{j\omega t}$ and solve
- $(j\omega + \frac{1}{\tau})\hat{p} = e\hat{E}$ or $\hat{p} = \frac{\tau e\hat{E}}{1+j\omega\tau}$.
- This results in a complex, frequency dependent σ :

$$\sigma = \sigma_{DC} \frac{1}{1 + j\omega\tau} = \frac{\sigma_{DC}}{1 + (\omega\tau)^2} (1 - j\omega\tau)$$

- With $\tau \approx 10^{-14}$ s, $\omega\tau \ll 1$ for frequencies up to many THz...
- To describe a perfect conductor one may let $\tau \rightarrow \infty$ in the equation $\frac{dp}{dt} = eE - \frac{p}{\tau}$ this leads to first London equation (see later)

Scattering mechanisms, mean free path, dependence on temperature, RRR

- In a perfect crystal, electrons will travel unhindered due to their wave nature: the wave is diffracted by the lattice and reforms unchanged
- The lattice is not perfect, but is always distorted due to
 - thermal vibrations of the lattice ions (phonons)
 - Structural defects (missing atoms, dislocation planes, grain boundaries)
 - Chemical impurities (foreign atoms, for example interstitial gas or substitutions with atoms having the same valence but different atomic radius)
- As the temperature is decreased, the first contribution fades out
- The conductivity remains finite due to defects and impurities
- The ratio of 300 K to low temperature (for instance, 10 K) resistivity is called RRR and is a gauge of the sample purity and its deviations from a perfect crystal

Anomalous skin effect

The relation between skin depth δ and surface resistance R_n , $\delta R_n \sigma \equiv 1$, only holds as long as the mean free path ℓ of the electrons is smaller than the skin depth, $\ell \ll \delta$.

At high frequency, or for high material purity and/or low temperatures, the electron mean free path can become larger than the skin depth, (or δ become smaller than ℓ)

Locality breaks down, Ohms law becomes invalid

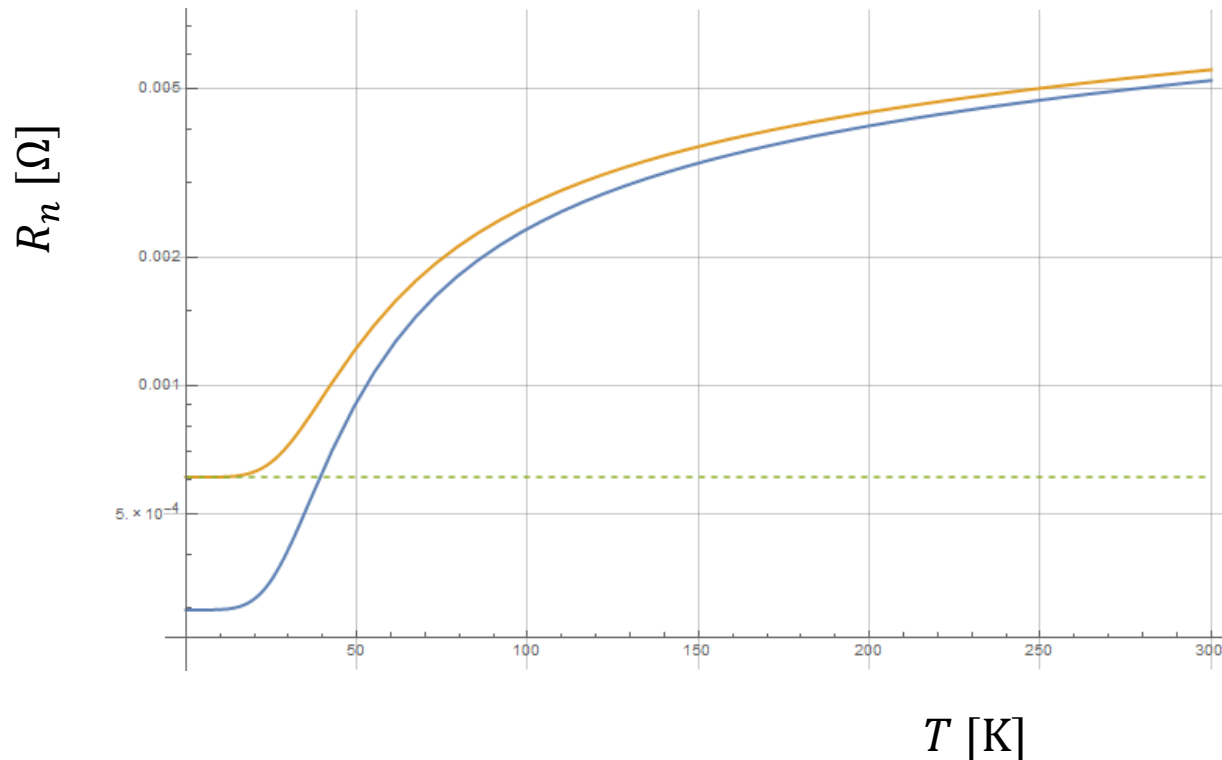

Outline - part 1

- Basics of RF Superconductivity
 - Kirchhoff's breakdown, transmission lines, resonators, accelerating cavities
 - Figures of merit, surface impedance,
- Basics of RF SuperConductivity
 - Drude Model, mean free path, Skin effect, Anomalous skin effect
- **Basics of RF Superconductivity**
 - Phenomenology
 - Theories of superconductivity
 - Surface impedance of superconductors
 - Residual resistance
 - Critical fields

Fundamental manifestations of the superconducting state: macroscopic quantum phenomena

- Perfect diamagnetism
 - Meissner and Ochsenfeld, [*Naturwissenschaften*. 21 \(44\): 787–788, \(1933\)](#)
 - Not what is expected from a perfect conductor, which would oppose to any flux change
 - Superconductivity is a thermodynamic **state**
 - Can't be explained classically

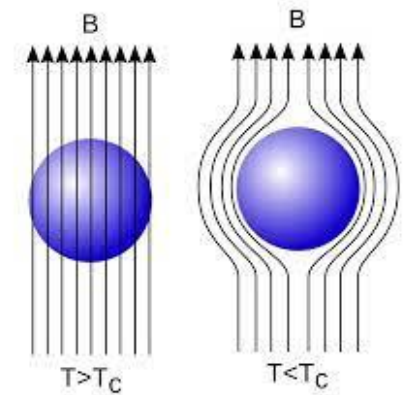

Zero resistance

- Zero DC resistivity
 - Kamerlingh Onnes, 1911
 - Best measured by inducing currents in superconducting loops
lifetime > 100000 years
 - Theoretical reasons to believe resistivity is actually zero

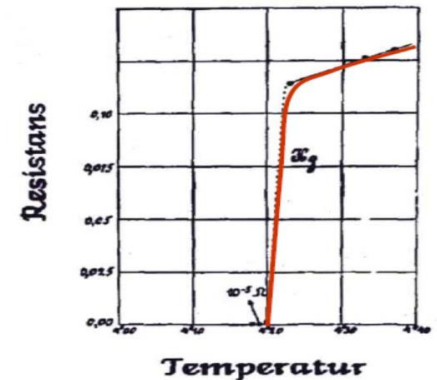
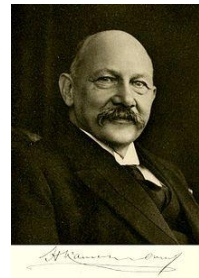

- Flux quantization: the flux through a thick superconducting ring is quantized in units of $\Phi_0 = \frac{h}{2e} \sim 2 \cdot 10^{-15} \text{ Wb}$
 - A consequence of the existence of a macroscopic wavefunction (order parameter) describing the superconducting charge carriers and of its single valuedness

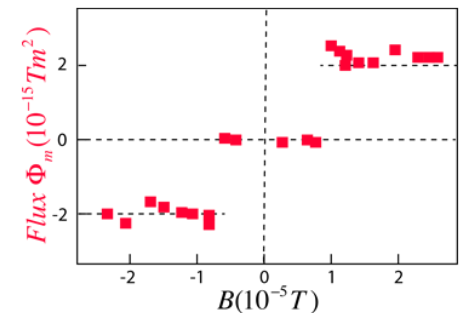

Quantized magnetic flux in a superconducting ring.
B. S. Deaver and W. M. Fairbank, Phys. Rev. Lett. 7, 43 (1961)

Periodic Table of the Elements

H	
Li	Be
Na	Mg
K	Ca
Rb	Sr
Cs	Ba
Fr	Ra

Sc	Ti	V	Cr	Mn	Fe	Co	Ni	Cu	Zn
Y	Zr	Nb	Mo	Tc	Ru	Rh	Pd	Ag	Cd
Lu	Hf	Ta	W	Re	Os	Ir	Pt	Au	Hg

B	C	N	O	F	He
Al	Si	P	S	Cl	Ne
Ga	Ge	As	Se	Br	Kr
In	Sn	Sb	Te	I	Xe
Tl	Pb	Bi	Po	At	Rn

La	Ce	Pr	Nd	Pm	Sm	Eu	Gd	Tb	Dy	Ho	Er	Tm	Yb
Ac	Th	Pa	U	Np	Pu								

Al

Superconductors

Si

Superconductors under high pressure or in thin films

Fe

Metallic with Magnetic order

Li

Metallic but not yet found to be superconductors

B

Non Metallic

Critical temperatures

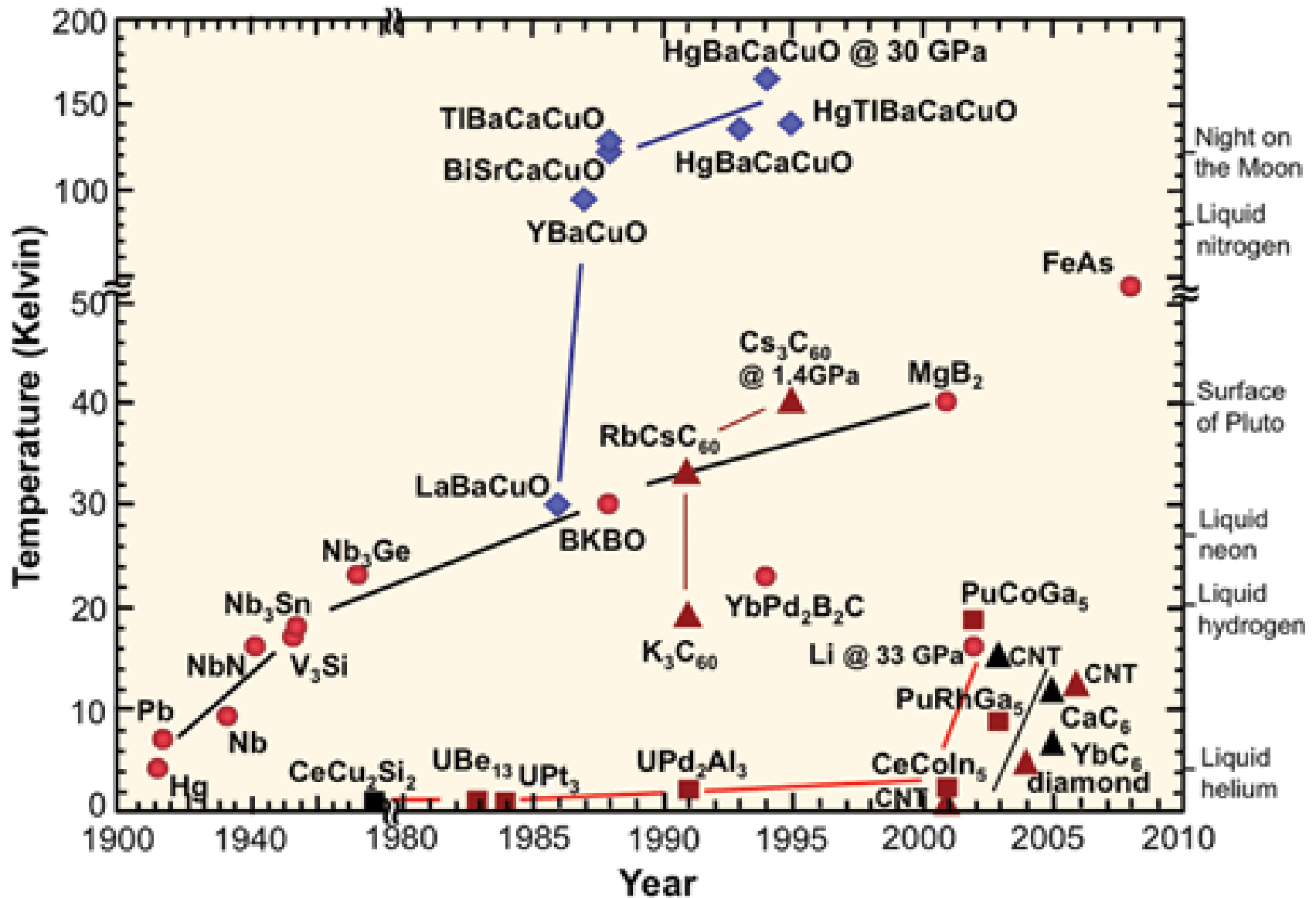

Phenomenology of superconductors

- Phase diagram - critical surface
 - The superconducting state is stable for: $T < T_C$, $B < B_C$, $J_c < J_C$
 - Superconductivity is destroyed if any of the critical values is overcome
- Specific heat jump at T_C
 - Phase transition without latent heat at $T=T_C$
 - Latent heat if transition is at $T < T_C$, $B = B_C(T)$
 - Can compute entropy, showing that superconducting state is more ordered than normal state
 - Low T behaviour indication of the presence of a gap in the energy spectrum
- Isotope effect
 - For a given superconducting element T_C is dependent on the isotopic mass: $T_C \sim M^{-\alpha}$, $\alpha \cong 0.5$
 - Not strictly obeyed, deviations for some materials
 - Indication that the ion lattice is involved in the mechanism behind superconductivity

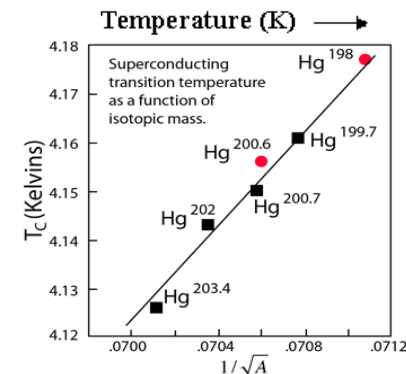
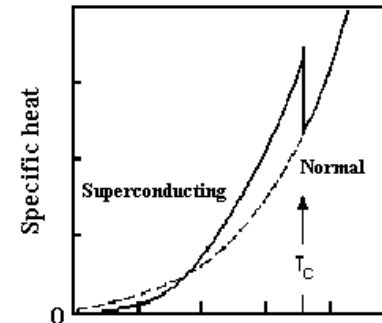
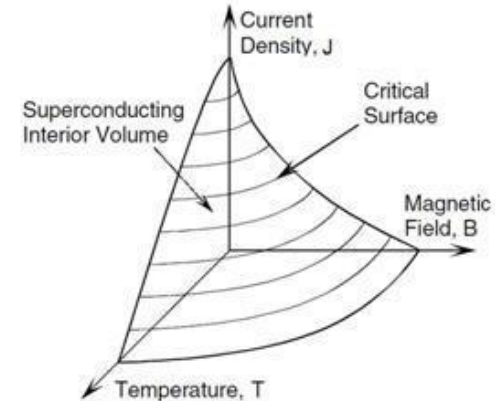

Type II superconductors

- For some materials, particularly alloys, superconductivity is not destroyed at the thermodynamic critical field H_c (field at which the free energies of NC and SC are equal).
- There are 3 critical fields (actually more, this is just a simplified picture), and a more complex phase diagram
- In the Meissner state we have perfect diamagnetism, supercurrents shield completely the bulk of the material where $B=0$

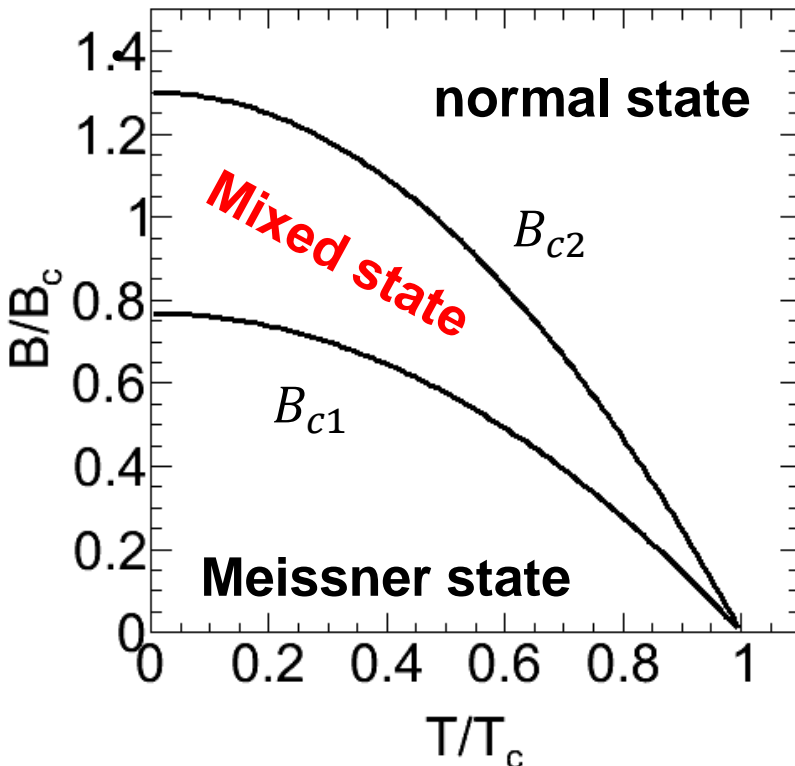

In the mixed state, the material is still superconducting in many respects, but bulk magnetization develops in the form of a lattice of flux quanta (vortices). This can be evidenced by magnetization measurements and even visually.

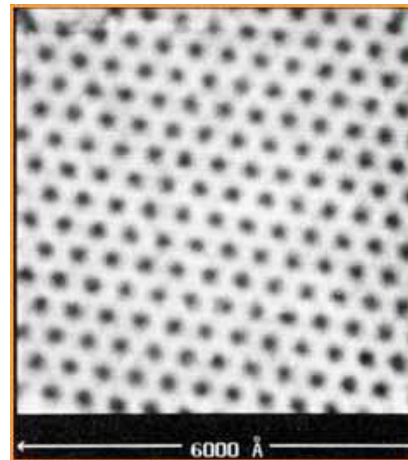

**STM image of
Vortex lattice, 1989**
H. F. Hess et al.
Phys. Rev. Lett. 62,
214, 1989

Theories of superconductivity

- Two fluid model (Gorter and Casimir, 1934)
 - Ad hoc model, captures essential features of the thermodynamics.
 - Temperature dependencies of entropy, specific heat, normal and superfluid densities
- London equations (London brothers, 1935)
 - Incorporate Meissner effect and perfect conductivity. London penetration depth replacing skin depth. Can be coupled with macroscopic quantum description to give an efficient model for engineering calculations (Orlando-Delin, 1991)
- Ginzburg Landau theory (1950)
 - based on Landau's theory of second order phase transitions
 - Strictly valid only close to T_c
 - Proved by Gor'kov to be equivalent to the BCS in its validity domain
 - Abrikosov found special solutions describing type II superconductors
- Pippard's extension of London model (1953)
 - Based on Brian's work on the anomalous skin effect, introduced coherence length, surface energy and other useful concepts
- BCS theory (1957)
 - First microscopic "first principle theory"
 - Boson condensation of Cooper pairs, explains the isotope effect, energy gap and relation to T_c
 - Still a simplified model (approximated Hamiltonian, spherical Fermi surface, etc.)
- More advanced theories (TDGL, Eliashberger, Eilenberger, non equilibrium SC, etc.)

Two fluid model

$$n = n_n + n_s$$

$$\mathbf{J} = \mathbf{J}_n + \mathbf{J}_s$$

Two types of charge carriers coexist and do not interact. Normal carriers and super electrons

The total density of carriers remains constant, the fractions of normal and “super” electrons change with temperature

The model can be applied for a local and clean superconductor (although these concepts were clarified much later).

Initially used to describe thermodynamics, it was then combined with London equations

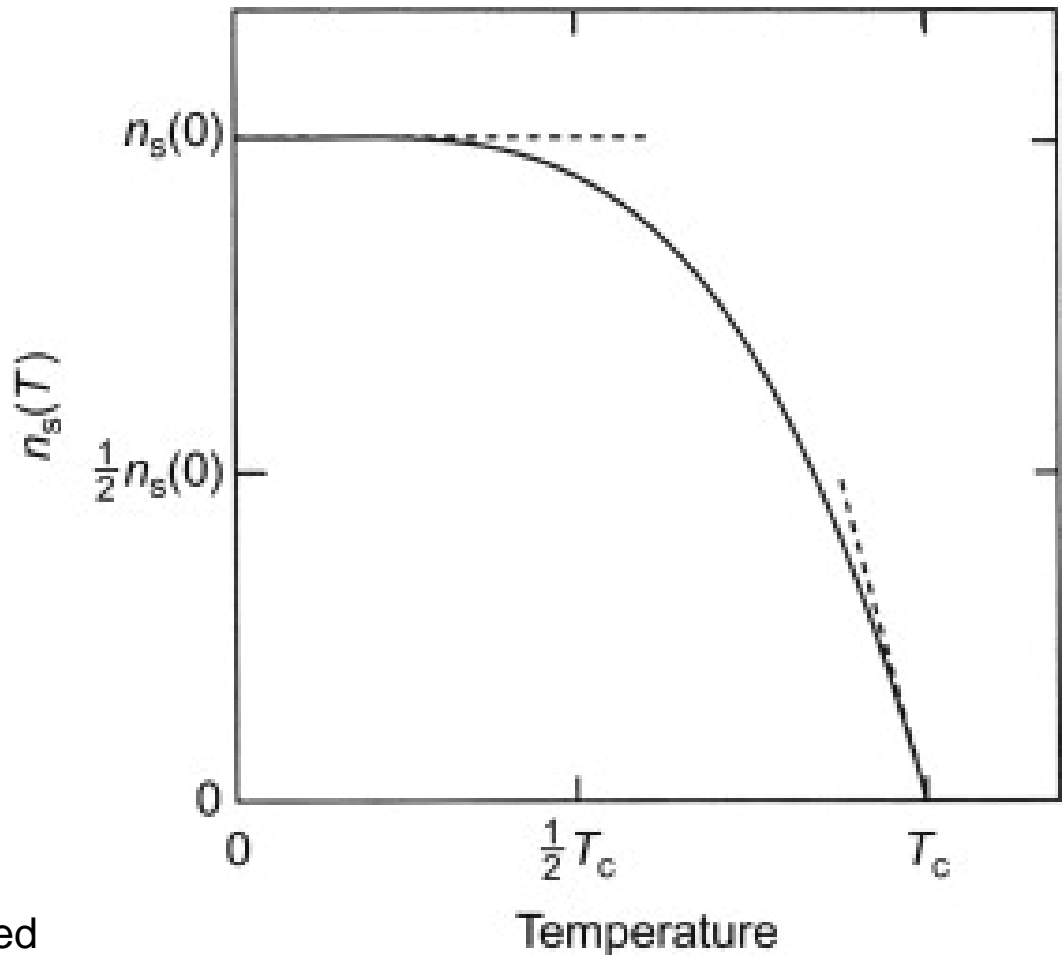

London equations

- First London equation: free acceleration of “super” charge carriers: Drude model without friction term:

$$m \frac{d\vec{v}_s}{dt} = e\vec{E} \quad \longrightarrow \quad \frac{d\vec{J}_s}{dt} = \frac{n_s e^2}{m} \vec{E}$$

\uparrow
 $J_s = n_s e v_s$

Define $\lambda_L = \sqrt{\frac{m}{\mu_0 n_s e^2}}$: London penetration depth, $\frac{d\vec{J}_s}{dt} = \frac{1}{\mu_0 \lambda_L^2} \vec{E}$

- Second London equation: taking the curl of 1st equation and using Maxwell equation $\nabla \times E = -\frac{\partial B}{\partial t}$ gives:

$$\frac{\partial}{\partial t} (\nabla \times J_s - \frac{1}{\mu_0 \lambda_L^2} B) = 0$$

- The arbitrary constant is set to zero to account for Meissner effect

London equations

$$(\nabla \times J_s - \frac{1}{\mu_0 \lambda_L^2} B) = 0$$

- Taking the curl

$$\nabla \times (\nabla \times J_s - \frac{1}{\mu_0 \lambda_L^2} B) = 0$$

- Use again Maxwell equations: $\nabla \times B = \mu_0 J \rightarrow \nabla \times \nabla \times B = \mu_0 \nabla \times J$

$$\nabla^2 B = \frac{B}{\lambda_L^2}$$

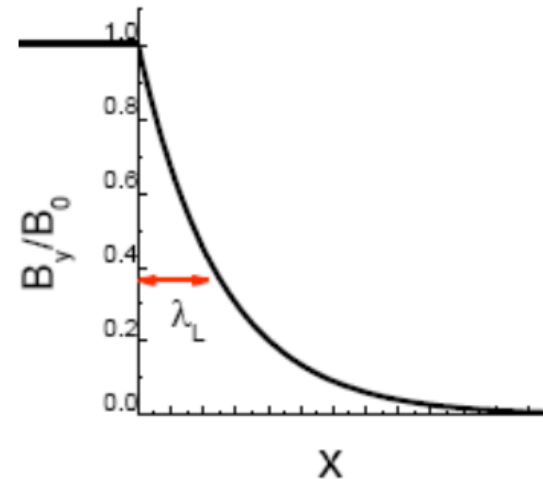
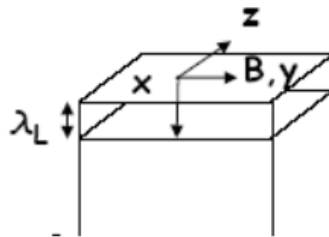

London equation + two fluid model → electrodynamics response of superconductors

Supercurrent

$$\left. \begin{aligned} \frac{\partial J_s}{\partial t} - \frac{n_s e^2}{m^*} E &= 0 \\ J_s &= J_0 \exp(i\omega t) \end{aligned} \right\} \begin{aligned} J_s &= -i \frac{n_s e^2}{m^* \omega} E \\ &\equiv \sigma_s \end{aligned}$$

Normal current

Ohm's law →

$$J_N = \frac{n_N e^2 \tau}{m^*} E \equiv \sigma_N$$

Total current induced by RF

$$J = J_s + J_N \rightarrow J = (\sigma_N - i\sigma_s)E$$

Dissipation by quasi-particles → resistive Inertia of Cooper pairs → inductive

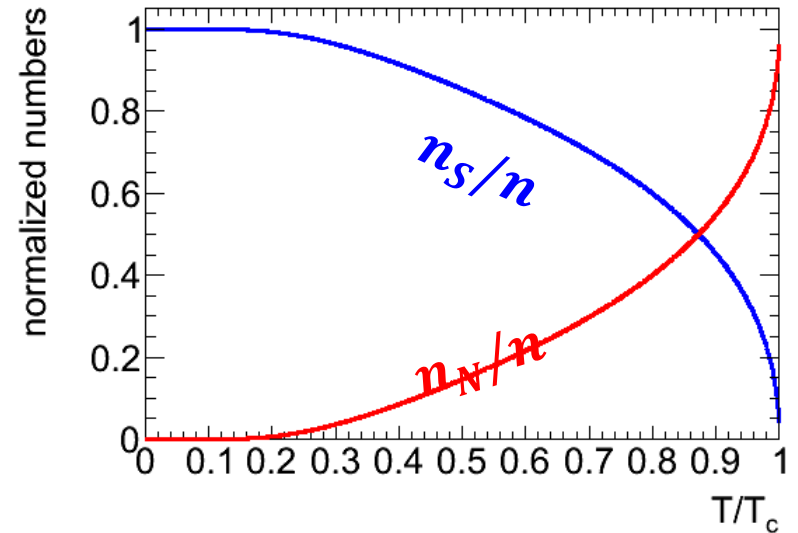

Equivalent circuit

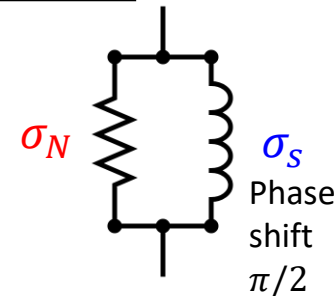

Two fluid model

Surface resistance

In normal conductors $R_s = \frac{1}{\sigma \delta}$

In superconductors: $\sigma \rightarrow \sigma_n + i\sigma_s$, and $\delta \rightarrow \lambda_L$

$$R_s = \operatorname{Re} \left\{ \frac{1}{(\sigma_n + i\sigma_s)\lambda_L} \right\} \cong \frac{1}{\lambda_L} \frac{\sigma_n}{\sigma_s^2}$$

$$\sigma_n = \frac{e^2 \tau n}{m} = \frac{e^2 n \ell}{m v_F} \propto \ell \exp\left(-\frac{\Delta(T)}{k_B T}\right) \quad \sigma_s = \frac{1}{\lambda_L^2 \mu_0 \omega}$$

$$R_s \propto \lambda_L^3 \omega^2 \ell \exp\left(-\frac{\Delta}{k_B T}\right)$$

- Resistance from the motion of the normal fluid under the electrodynamic force
- In BCS theory: quasi-particles: thermal excitations from the ground state at $T > 0$
- **R_s proportional to the cube of London penetration depth (dominant at T_c)**
- **R_s proportional to the mean free path (!)**
- **R_s exponentially decreases with T like the number of quasi-particles**
- **In superconductors, R_s scales with RF frequency squared**

Pippard's non local electrodynamics

Working with diluted tin alloys Pippard found that the penetration depth was dependent on the purity, it increased as the material got dirtier...

$$\lambda(l, T) = \lambda_L(T) \sqrt{1 + \frac{\xi_0}{l}}$$

He introduced the coherence length ξ as the distance over which the density of superconducting carriers can change, and derived an expression for ξ_0 using the uncertainty principle: $\xi_0 \propto \frac{\hbar v_F}{k T_c}$, only slightly different from the accurate value given by the BCS theory. Also ξ depends on the purity (m.f.p), so that an effective coherence length is given by:

$$\frac{1}{\xi} = \frac{1}{\xi_0} + \frac{1}{l}$$

“Clean” limit: $l \gg \xi$, “dirty” limit: $l \ll \xi$

Pippard's non local electrodynamics

As impurities are added, the electronic mean free path gets shorter, the magnetic penetration depth gets larger, and the coherence length gets smaller. The e.m. response is “local” because the superconducting carriers only “see” the local field.

London's equation applies:
$$J_s = -\frac{1}{\mu_0 \lambda_L^2} \mathbf{A}$$

However, as materials get cleaner the superconducting carrier density spans over changing fields, so the current density in a given point does not depend on the value of the vector potential at the same spot. Pippard, in analogy with the anomalous skin effect he had studied, proposed to replace London's equation with

$$\vec{J}_s(\vec{r}) = -\frac{3}{4\pi\xi_0\lambda_L^2} \int_V \frac{\vec{R}\vec{R} \cdot \vec{A}(\vec{r}') e^{-R/\xi}}{R^4} d\vec{r}'$$

BCS ideas - Cooper pairs

- Cooper theorem (1956): the Fermi sea is unstable against the presence of an attractive potential between electrons, no matter how small
- An attractive potential can indeed arise mediated by the ion lattice, and electrons can form bound states of lower energy (Cooper pairs)
- While electrons are fermions, Cooper pairs are bosons.
- So they can escape Pauli's exclusion principle and collapse in the same ground state (Bose condensation)
- Cooper pairs belong all to the same quantum state and have the same energy.
- While NC electrons are scattered by the ion lattice leading to resistive losses, Cooper pairs are not.

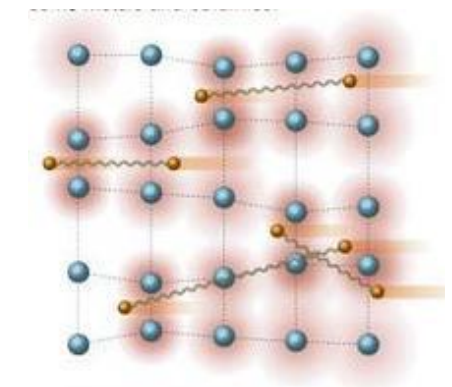
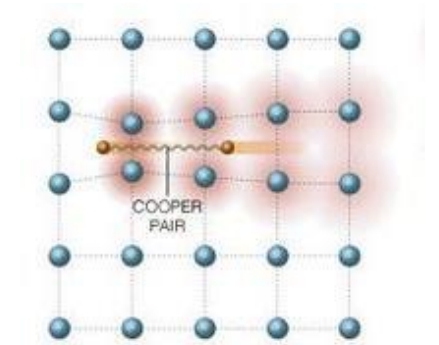
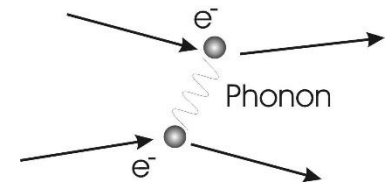

BCS theory (1957)

- The superconducting state consists of electron pairs and elementary excitations, quasiparticles, behaving almost like free electrons
- This gives precise meaning to the two fluids of previous ad hoc models
- BCS use the formalism of second quantization to treat the many body problem and work out the observables

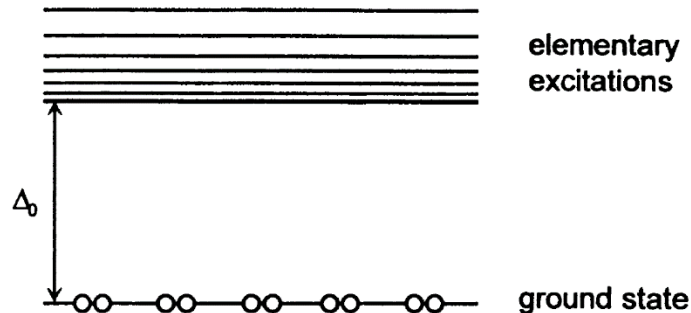

The energy gap Δ separates the energy levels of elementary excitations from the ground state level. At 0 K, only the ground state is occupied.

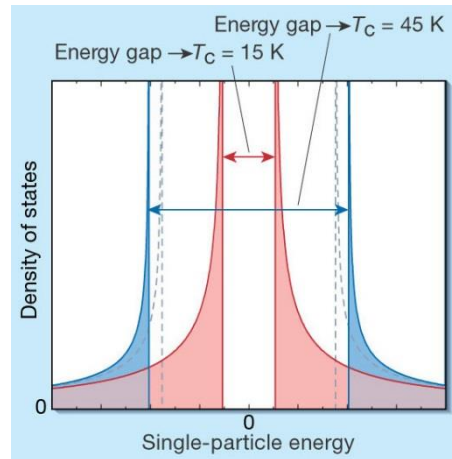

Density of elementary excitations. There are no states within the energy gap Δ .

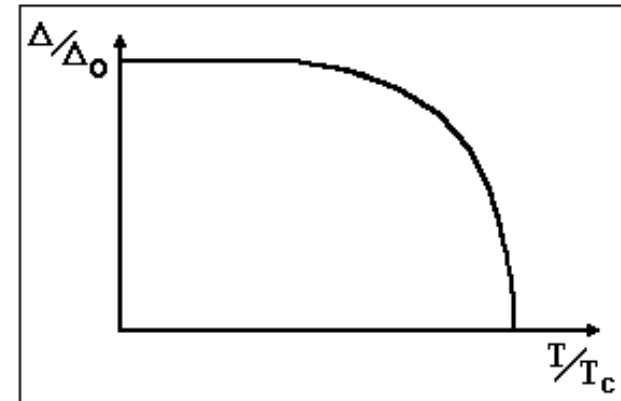

Temperature dependence of Δ :

$$\Delta(T) \approx \Delta(0 \text{ K}) \sqrt{\cos\left(\frac{\pi}{2}\left(\frac{T}{T_c}\right)^2\right)}$$

BCS surface impedance

- The surface impedance can be calculated in the context of the BCS theory. This was done by Mattis and Bardeen in 1958 (and independently by Abrikosov et al. in 1959, using time dependent perturbation theory)
- They **considered only** the linear response to **weak fields**
- Calculations are somewhat daunting...

$$\begin{aligned}
 I(\omega, R, T) = & -\pi i \int_{\epsilon_0 - \hbar\omega}^{\epsilon_0} [1 - 2f(E + \hbar\omega)] \\
 & \times [g(E) \cos(\alpha\epsilon_2) - i \sin(\alpha\epsilon_2)] e^{i\alpha\epsilon_1} dE \\
 & - \pi i \int_{\epsilon_0}^{\infty} \{ [1 - 2f(E + \hbar\omega)] \\
 & \times [g(E) \cos(\alpha\epsilon_2) - i \sin(\alpha\epsilon_2)] e^{i\alpha\epsilon_1} - [1 - 2f(E)] \\
 & \times [g(E) \cos(\alpha\epsilon_1) + i \sin(\alpha\epsilon_1)] e^{-i\alpha\epsilon_2} \} dE,
 \end{aligned}$$

$$\begin{aligned}
 \frac{\sigma_1}{\sigma_N} = & \frac{2}{\hbar\omega} \int_{\epsilon_0}^{\infty} [f(E) - f(E + \hbar\omega)] g(E) dE \\
 & + \frac{1}{\hbar\omega} \int_{\epsilon_0 - \hbar\omega}^{-\epsilon_0} [1 - 2f(E + \hbar\omega)] g(E) dE, \\
 \frac{\sigma_2}{\sigma_N} = & \frac{1}{\hbar\omega} \int_{\epsilon_0 - \hbar\omega, -\epsilon_0}^{\epsilon_0} \frac{[1 - 2f(E + \hbar\omega)] (E^2 + \epsilon_0^2 + \hbar\omega E)}{(\epsilon_0^2 - E^2)^{\frac{1}{2}} [(E + \hbar\omega)^2 - \epsilon_0^2]^{\frac{1}{2}}} dE
 \end{aligned}$$

$$\begin{aligned}
 \mathbf{j}(\mathbf{r}, t) = & \sum_{\omega} \frac{e^2 N(0) v_0}{2\pi^2 \hbar c} \\
 & \times \int \frac{\mathbf{R} [\mathbf{R} \cdot \mathbf{A}_{\omega}(\mathbf{r}')] I(\omega, R, T) e^{-R/|\mathbf{r}'|} d\mathbf{r}'}{R^4}
 \end{aligned}$$

Mattis and Bardeen Phys Rev 111 2 1958

Abrikosov et al JTEP 35 182 1959

Numerical codes and analytical formulas

- J. Halbritter (1970) wrote a numerical code to calculate Z_s as a function of T and material parameters $(\xi_0, \lambda_L, T_c, l)$
- A modern version of this code is maintained and accessible on <http://www.lepp.cornell.edu/~liepe/webpage/researchsrimp.html>
- Analytical approximations: a good approximation in the dirty limit and for $T < \frac{T_c}{2}$ and $\omega < \frac{\Delta}{\hbar}$ is

$$R_{BCS} = \frac{\mu_0^2 \omega^2 \lambda^3 \sigma_n \Delta}{k_B T} \ln \left[\frac{C_1 k_B T}{\hbar \omega} \right] \exp \left[-\frac{\Delta}{k_B T} \right]$$

- Often a further simplification is used to fit experimental data:

$$R_{BCS} = \frac{A}{T} \exp \left[-\frac{\Delta_0}{k_B T} \right]$$

- Remember this is valid at low RF field only!

Numerical calculation vs simple formula

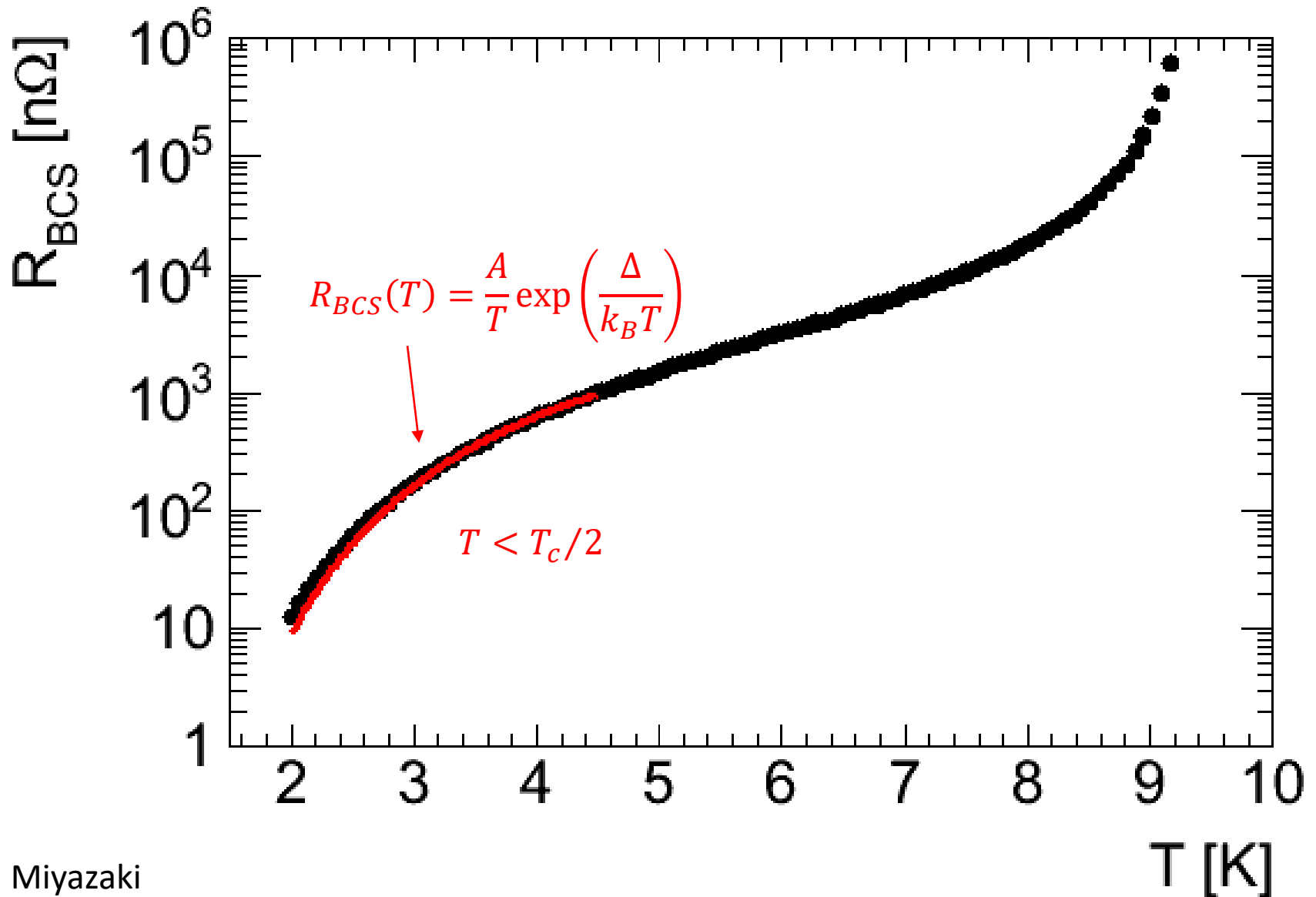

BCS resistance vs material purity

- Remember Pippard: $\lambda(l, T) = \lambda_L(T) \sqrt{1 + \frac{\xi_0}{l}}$ and that $R_S \propto \lambda^3 \omega^2 l$
- Consequently, R_S has a minimum as a function of l .

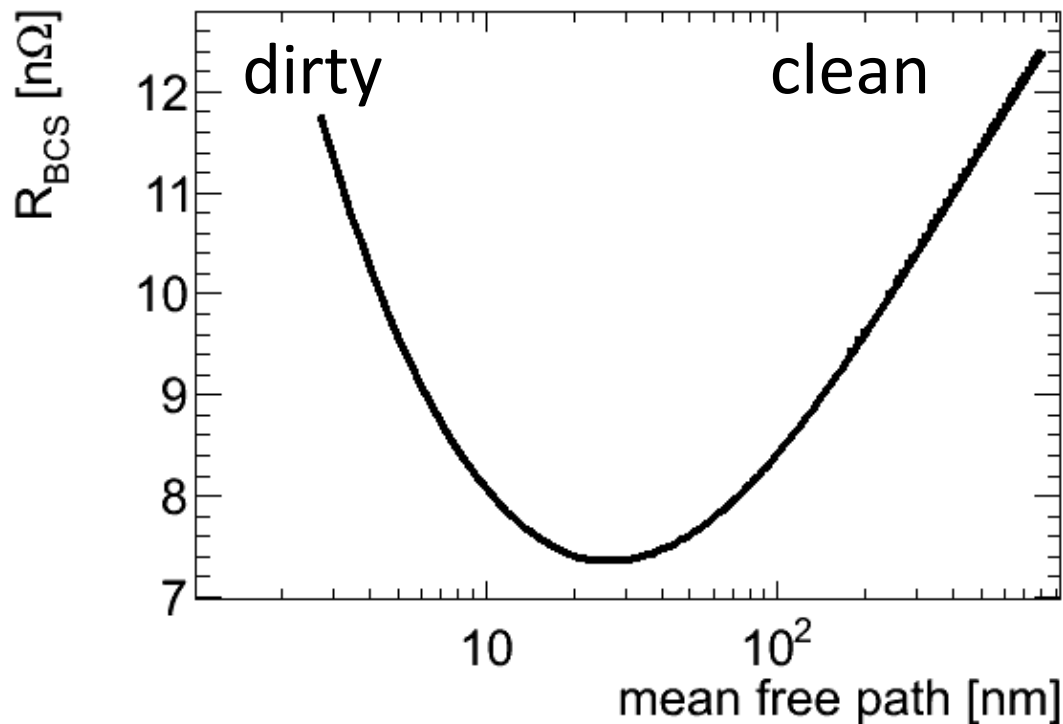

Residual resistance

$R_{\text{BCS}} \rightarrow 0$ for $T \rightarrow 0$. In reality, at low T , R_s approaches a constant value

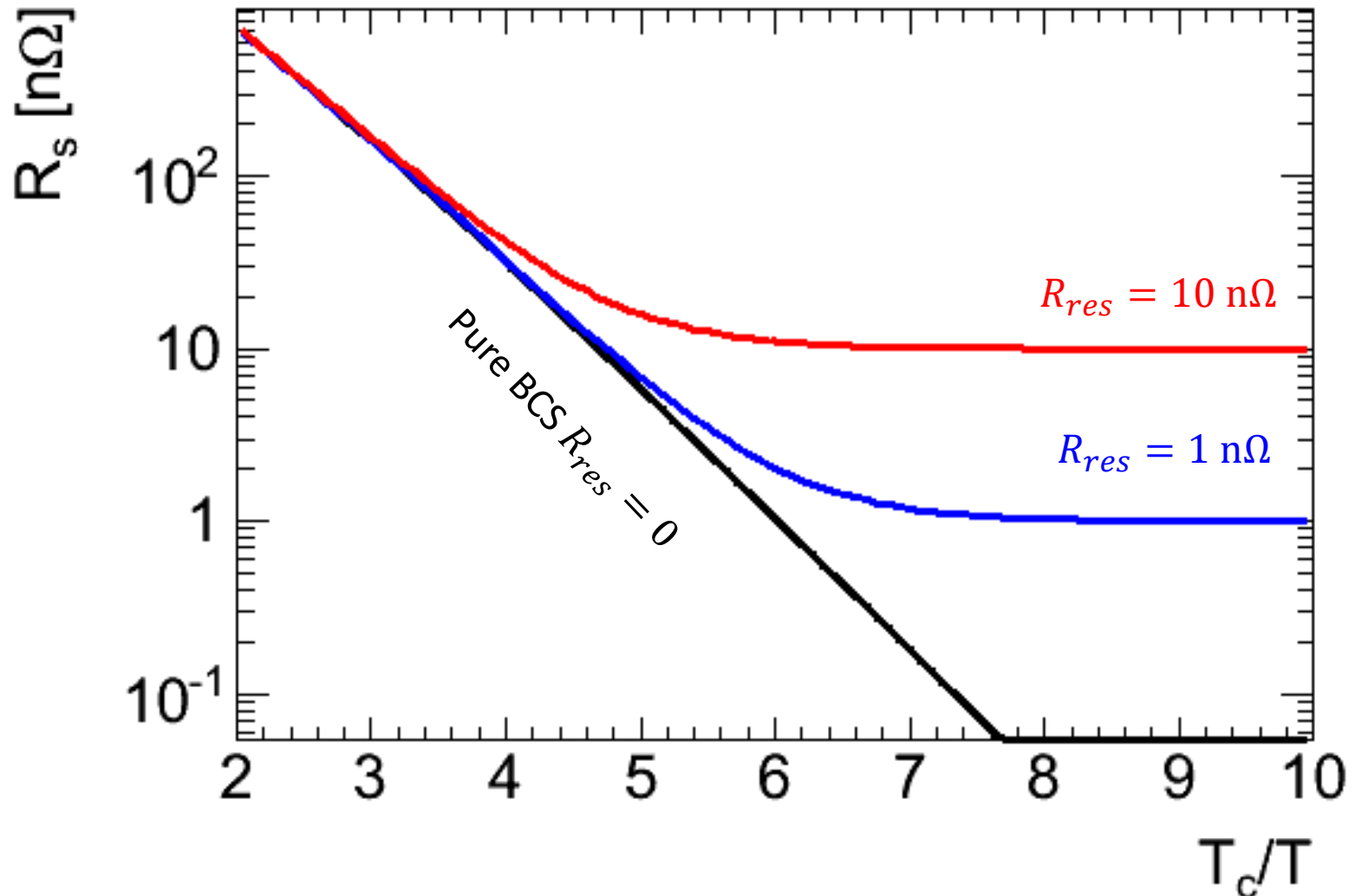

Residual resistance

- Empirically: $R_S = R_{BCS} + R_{res}$
- R_{BCS} is only known at low field, so the decomposition is valid only at low field
- R_{res} is due to several factors, some well understood, some not.
- A lot of theories...
- Known sources of R_{res} include:
 - Non superconducting phases (oxides, hydrides, non stoichiometric phases, inclusions)
 - Magnetic flux trapped (vortex oscillations)
 - Parasitic losses in the set-up (for example cavity flanges)

Residual resistance due to trapped magnetic flux

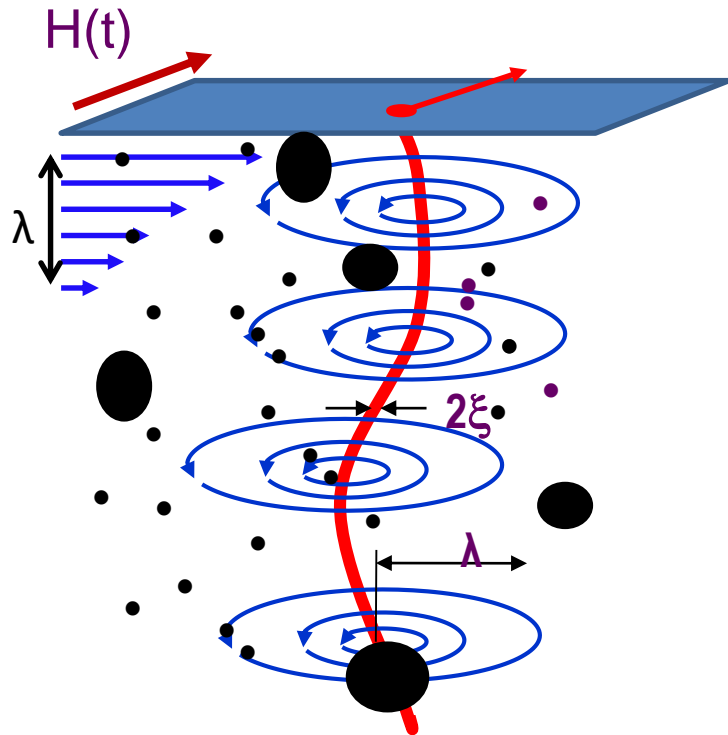

When cooling down a cavity below T_c the Meissner effect can be incomplete due to pinning of the fluxons when H_{c1} is very small...

Trapped fluxons oscillate in the RF fields leading to dissipation

The resulting component of the residual resistance can be factored as

$$R_{fl} = B_o \eta(l, \nabla T, \dots) S(l, \omega, B_{RF})$$

↑
↑
↑

Ambient field Expulsion efficiency Sensitivity

Critical fields- Field limitations in RF

- $H < H_{c1}$: perfect Meissner state
- $H_{c1} < H < H_{c2}$:penetration and oscillation of vortices give rise to strong dissipation in RF fields. Not much better than a normal conductor.
- However, the Meissner state can remain metastable for $H_{c1} < H < H_{sh}$, as vortices have to overcome an energy barrier to enter the material (Bean-Livingston barrier).
- Calculations of H_{sh} in some particular cases (for example the extreme dirty limit) were done using GL theory
- The general calculation of H_{sh} for all temperatures and all purities is still missing, so the ultimate field limit remains unknown

