

IFAST 1st Annual Meeting, May 2-6, 2022, CERN

IFAST-WP6: TASK 6.2 “LASPLA” LASers for PLasma Accelerators

Leonida A. GIZZI, CNR, Italy

Also on behalf of Task 6.4 “LS3” - Francois MATHIEU, CNRS, France

iFAST



This project has received funding from the European Union's Horizon 2020 Research and Innovation programme under GA No 101004730.

Task 6.2 LASers for Plasma Acceleration

- CNR, CERN, INFN, CNRS, DESY,
- THALES and AMPLITUDE Technologies

LASPLA team

L.A.Gizzi (CNR)
F. Mathieu (CNRS),
F. Falcoz (AT),
C. Simon Boisson (Thales)
D. Giove, (INFN-MI)
M.P.Anania (INFN-LNF)

...

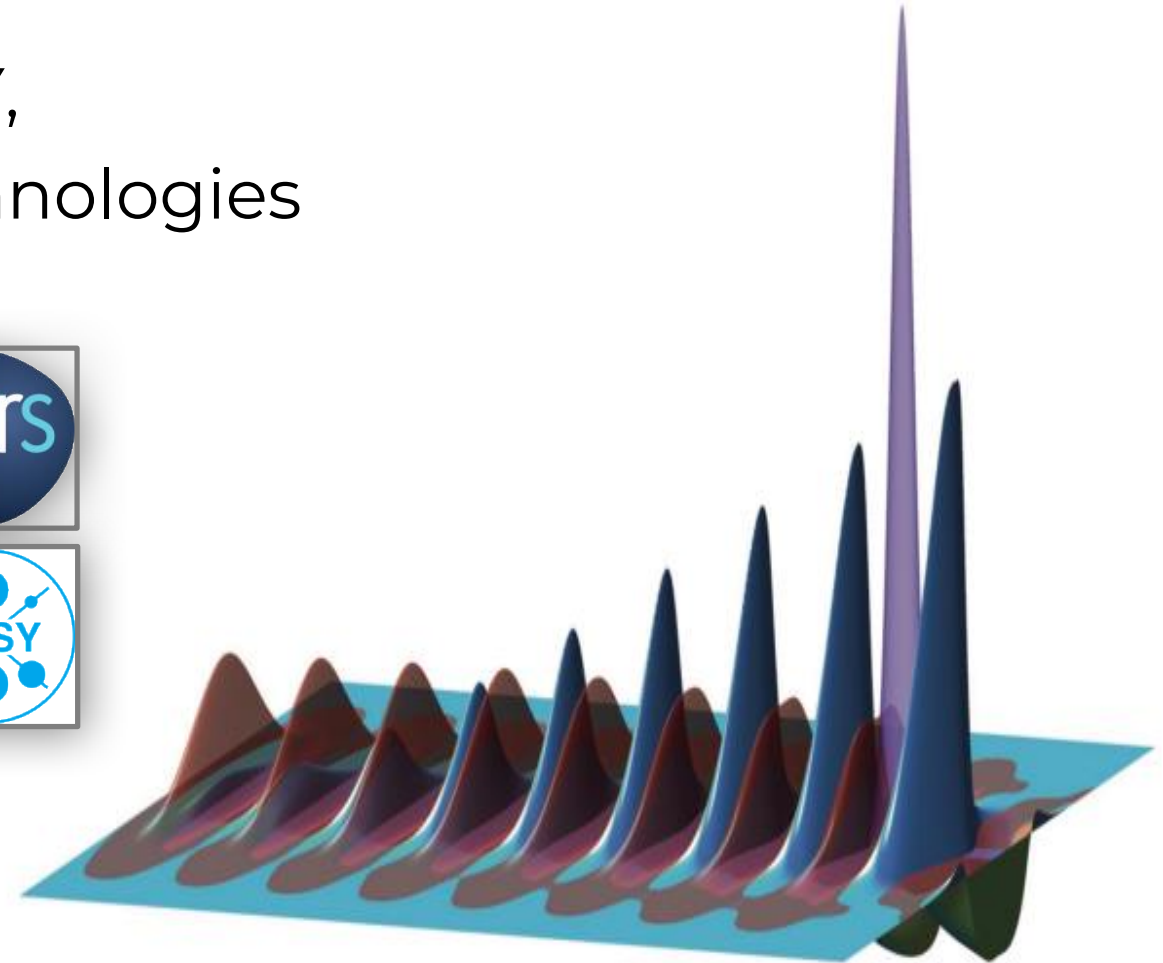

About I.FAST - Horizon 2020 (Research Innovation Action)

WP6: Novel particle accelerators concepts and technologies

Objectives

- Define a roadmap towards low-energy and high-energy physics applications
- Organise the biannual European Advanced Accelerator Concepts workshop (EAAC)
- Develop innovative targets for laser-plasma acceleration
- Demonstrate improved beam features with the new targets
- Develop a new passive system to improve beam-pointing stability
- Define solutions to stabilize beam profile in the focal spot and ensure a shot-to-shot stability of the Strehl ratio

Tasks

Task	Name	Task Leader
6.1	Novel Particle Accelerators Concepts and Technologies (NPACT)	R. Assmann (DESY)
6.2	Lasers for Plasma Acceleration (LASPLA)	L. Gizzi (CNR)
6.3	Multi-scale Innovative targets for laser-plasma accelerators	C. Thaury (CNRS)
6.4	Laser focal Spot Stabilization Systems (L3S)	F. Mathieu (CNRS)

Task 6.2: Objectives

- Establish a roadmap to foster delivery of advanced industrial laser drivers with high-repetition rate and higher efficiency, for the first user laser-plasma based accelerators.
- Establish a coordination activity with networking and training of main laser labs, focused on laser-driver R&D.
- **MS22** - LASPLA Workshop/School [M30] – Report
- **D6.2** : LASPLA Strategy [M46] - Strategy for laser drivers for plasma accelerators

Scenario on intense lasers

- Current laser technology development mainly driven by **extreme intensity** applications;
- Laser-Plasma **acceleration** has developed along with progress in laser performance;
- **Recent LWFA-FEL demonstration** [*] highlights the role of **laser stability and control**;
- **LASPLA** will focus on the technology required to achieve **high-repetition** rate at **multi-joule** (≈ 100 TW) scale [**], with high quality and enhanced control and stability;
- **Key role of industry** to establish turn-key, high average/peak power ultrashort pulse technology;

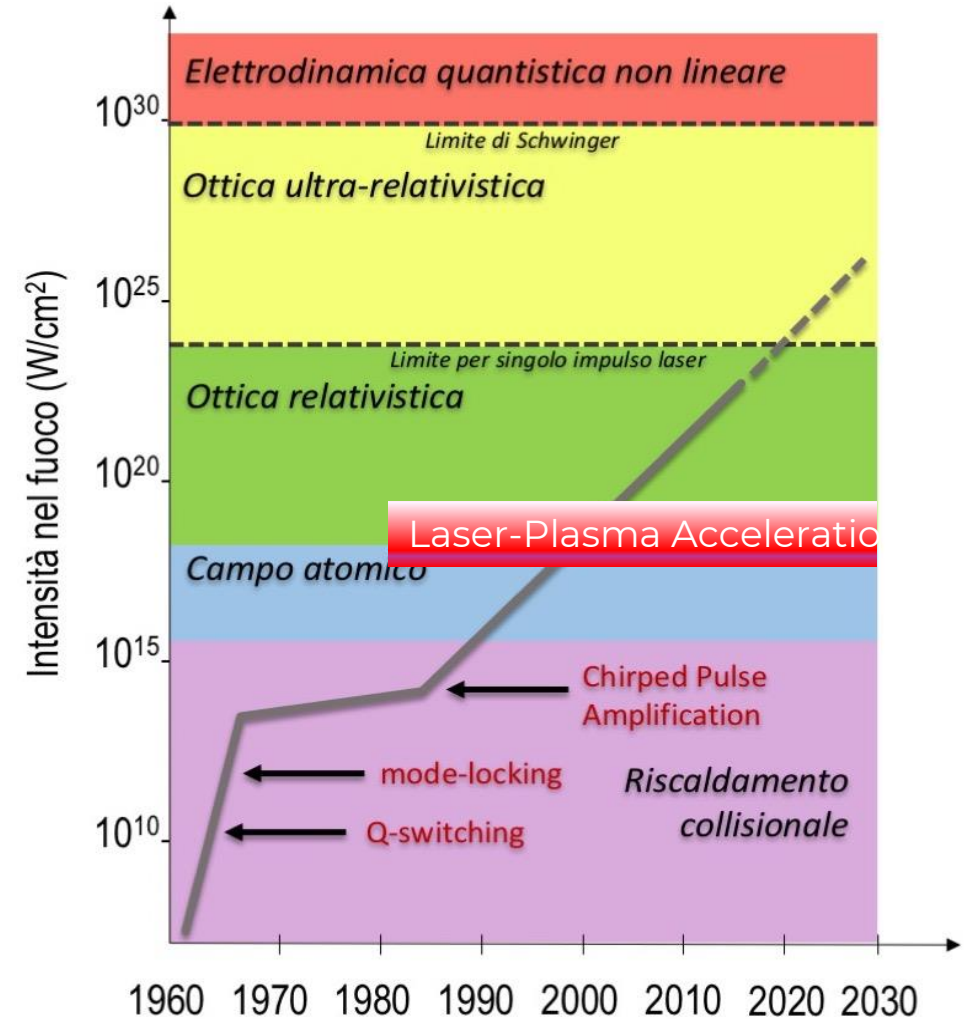

Currently explored R&D path

- High TRL Ti:Sa, 100 Hz, multi Joule scale (EuPRAXIA-Like) - 1-10 kW
- High TRL – Industrial development in progress at J level

- Short-medium term solution
- Proof-of-principle user laser accelerator
- Needs components testing

“Commercial” Ti:Sa kHz/<100 W front-end (< 100 mJ)

- Diode pumped, direct CPA, kHz, multi-Joule scale
- High efficiency with advanced lasing materials
- Optical parametric chirped pulse amplification (OPCPA) with diode pumping

- Longer term solution
- Scalable, efficient
- Needs high brightness, lower cost diode lasers for pumping
- Needs materials and components R&D

LASPLA Technical meetings

WP6 - NPACT-Novel particle accelerators concepts and technologies

Task 6.2 - LASPLA

1st Technical Meeting – 23rd June 2021

10.00 - "Introduction about IFAST/LASPLA" - Leo GIZZI/CNR, Italy

10.20 - "Overview of Laser Technology Developments @ CLF" - Paul MASON/STFC, UK

10.40 - "First acceleration experiments on Apollon" - Francois MATHIEU/CNRS Apollon, France

11.00 - "Overview of laser technology developments @ Thales" - Christophe SIMON BOISSON/THALES, France

11.20 - "New materials for pulse amplification at 1 and 2 microns" - Guido TOCI/CNR-INO, Italy

11.40 - "Tm:Lu2O3 amplifier design issues" - Luca LABATE/CNR-INO, Italy

12.00 - "Challenges for diode laser pump sources: high intensity & high repetition rate & efficiency & low €/W" - Paul CRUMP/FB, Germany

12.20 - Discussion and next meeting/conference - All

12.30 - Close

IFAST



This project has received funding from the European Union's Horizon 2020 Research and Innovation programme under GA No 101004730.

LASPLA Technical meetings

WP6 - NPACT-Novel particle accelerators concepts and technologies

Task 6.2 - LASPLA

2nd Technical Meeting – 7th October 2021

Session 1 (Convenor, L. GIZZI, CNR)

15.00 – Leonida A GIZZI, INO-CNR, Pisa, Italy, “Overview and motivation of the IFAST project”

15.15 - Georgia ADRIANAKI, HMU, Greece, “Experiencing the development of the ZEUS laser facility at IPPL for particle acceleration optimization experiments”

15.30 - Thomas M. SPINKA, LLNL, USA, - “Demonstration of a compact, multi-joule, diode-pumped Tm:YLF laser”,

15.45 – Roman WALCZAK, Clarendon Laboratory, Oxford, UK – “High-repetition-rate, GeV-scale accelerators driven by plasma-modulated laser pulses”

16.00 - Joachim HEIN, Jena University, Germany, “Prospects of high energy Tm lasers and first tests”

Session 2 (Chair Paul CRUMP, FBH)

16.30 – Luca LABATE, CNR-INO, Pisa, Italy, “Tm laser development for the ELITE infrastructure at CNR”

16.45 - Luis ROSO, CLPU, Salamanca, Spain, “Petawatt Lasers: High Repetition Rate Challenges”

17.00 - Victor MALKA, Weizmann Institute, Israel - “What about very high energy electrons radiotherapy (VHEE-RT) with compact laser plasma accelerators?”

17.15 - Andreas R. MAIER, Hamburg University, Germany - “High Average Power Laser-Plasma Acceleration”

17.30 – Conclusions/Next meeting (All)

IFAST



This project has received funding from the European Union's Horizon 2020 Research and Innovation programme under GA No 101004730.

LASPLA: map of active participation to technical meetings

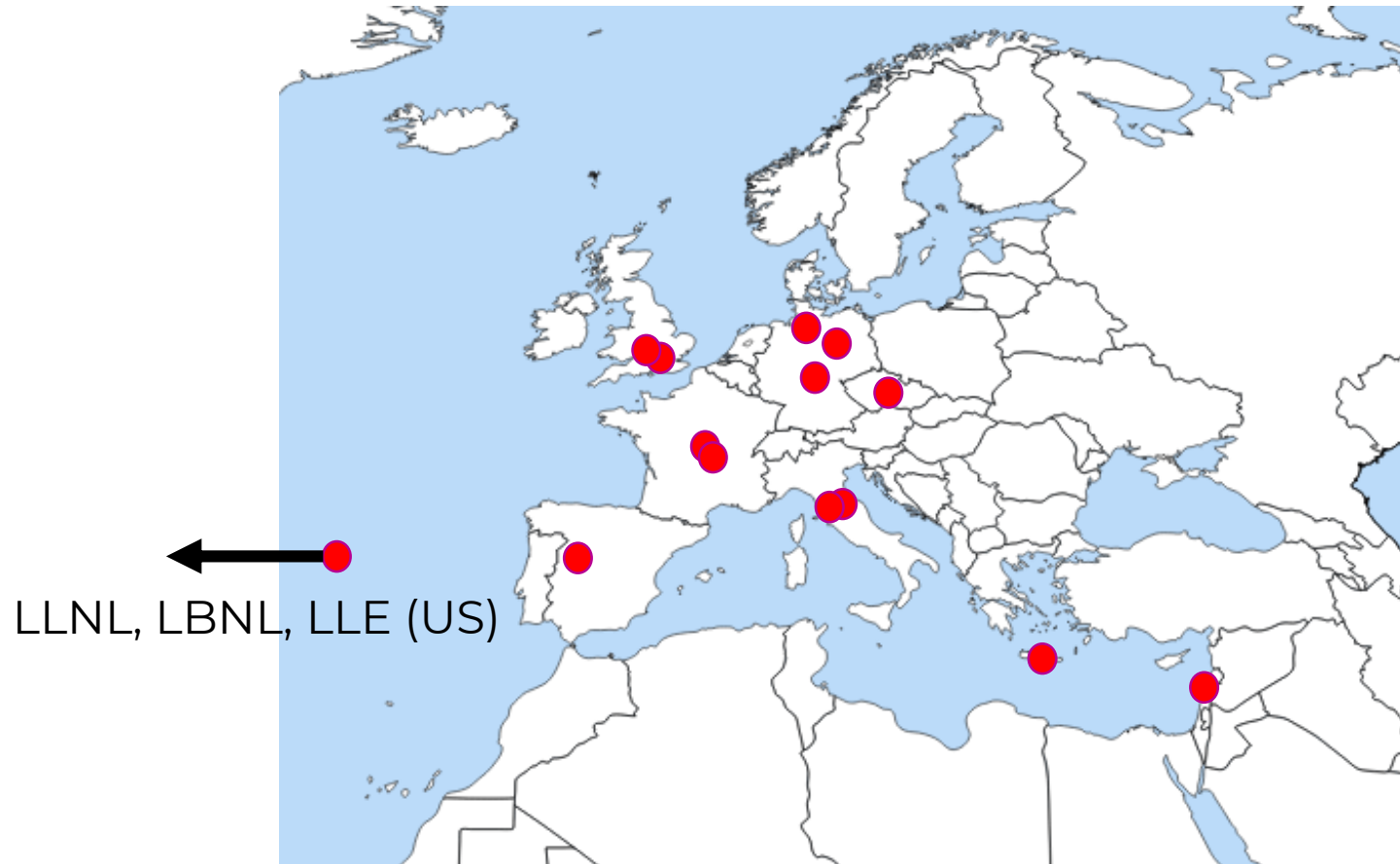

Up to 50 attendees to the 2nd technical meeting

Chair

- **G rard MOUROU**

Co-chairs

- **Leonida A. GIZZI (CNR)**
- **Fran ois MATHIEU (CNRS)**

Organizing Committee

- **Franck FALCOZ (Amplitude)**
- **Leonida A. GIZZI (CNR)**
- **Luca LABATE (CNR)**
- **Fran ois MATHIEU (CNRS)**
- **Daniele PALLA (CNR)**
- **Christophe SIMON-BOISSON (Thales)**

Scientific Secretariat

- **Leonida A. GIZZI (CNR)**
- **Fran ois MATHIEU (CNRS)**
-
-

LASER DRIVERS FOR PLASMA ACCELERATORS

iFAST (ifast-project.eu), funded through the EU's Horizon Europe 2020 Research & Innovation Programme is pursuing innovation in all accelerator technology through a comprehensive science programme and a large network of leading institutions. The iFAST project features a workpackage on Novel Particle Accelerators Concepts and Technologies (led by R. Assmann) including coordinated action towards the development of LASER DRIVERS and innovative TARGETS for plasma accelerators to drive the development of novel accelerators with specifications driven by user application and meeting industry standards.

The iFAST meeting on "LASER DRIVERS FOR PLASMA ACCELERATORS" will be held on April 20-23, 2022 in Palaiseau, Paris (FR). The workshop follows the the technical meetings of the LASer drivers for PLasma Acceleration (LASPLA) task of the iFAST (Innovation Fostering in Accelerator Science and Technology) held recently and providing a unique platform for discussion in this rapidly evolving area of research and development. Here the idea is to to drive the development of lasers with specifications driven by USER applications of high power and intense lasers for laser-plasma accelerators and other relevant user areas. This will require the development of systems which operate at very high repetition rates (100 Hz, kHz and beyond).

This workshop will contribute to the main objectives in this area, including:

- **Establish a roadmap** to foster delivery of advanced industrial laser drivers with high-repetition rate and higher efficiency;
- **Highlight laser requirements** for user plasma-based accelerators and other key high power, high intensity laser applications;
- **Promote a coordination activity** with networking and training of main laser labs and industry, focused on laser-driver R&D.

The meeting will be chaired by **Gerard MOUROU** and co-chaired by **Leonida A. GIZZI** and **Francois MATHIEU** and will be jointly organised by CNR, CNRS, Amplitude, Thales and Trumpf.

The workshop will deliver an overview on novel architectures, concepts and materials for ultra-short pulse laser amplification that are likely to become drivers for the first generation of user laser plasma accelerators like the EuPRAXIA Research Infrastructure that was recently included in the Roadmap 2021 of the European Strategy Forum of Research Infrastructures [EuPRAXIA](#). Participation is foreseen by representative from key laser and laser-plasma research Institutions and leading industries in the field. INVITED SPEAKERS will report on the latest progress at their respective laboratories and companies in all relevant areas including:



26 invited talks

PROGRAMME of the
I.FAST WORKSHOP 2022
“LASER DRIVERS FOR PLASMA ACCELERATORS”

École Polytechnique, Palaiseau,
 Paris (FR), 20-22 April 2022

Time	Wednesday 20	Thursday 21	Friday 22
09:00 – 09:30	REGISTRATION	Mike CAMPBELL, LLE, University of Rochester (*)	Jonathan Tyler GREEN, ELI Beamlines
09:30 – 10:00	OPENING and IFAST overview	Laura CORNER*, University of Liverpool	Francois MATHIEU, LULI-CNRS
10:00 – 10:30	Gérard MOUROU – Jonathan WHEELER, IZEST	Bedrich RUS, ELI Beamlines	Sandrine RICAUD, Thales LAS
10:30 – 11:00	Coffee break	Franck FALCOZ/Stefane BRANLY, Amplitude	Paul MASON, CLF-STFC
11:00 – 11:30	Sydney GALES, IJCLab & IFIN/ELI-NP	Coffee break	Coffee break
11:30 – 12:00	Andreas R. MAIER, DESY	Ralph ASSMANN, DESY and INFN (*)	Federico CANOVA, ELI-ERIC
12:00 – 12:30	Kevin CASSOU, CNRS/IN2P3/IJCLab, U. Paris Saclay	Andrea KNIGGE, Ferdinand-Braun-Institut	Luca LABATE, INO-CNR (*)
12.30 – 13.00	LUNCH	Markus LÖSER, Helmholtz-Zentrum Dresden	Cedric THAURY, LOA-CNRS
13:00 – 13:30		LUNCH	Closing
13:00 – 14:00			LUNCH
14:00 – 14:30			LUNCH
14:30 – 15:00	Cameron G. R. GEDDES, LBNL	Karoly OSVAY, NTL, University of Szeged	
15:00 – 15:30	Roman WALCZAK, University of Oxford	Leonida A. GIZZI, INO-CNR	
15:30 – 16:00	Tea Break	Tea Break	
16:00 – 16:30	Jérôme FAURE, LOA-CNRS	ROUND TABLE <i>“High average power accelerators for nuclear and medical uses”</i>	
16:30 – 17:00	Francois SYLLA, SourceLAB		
17:00 – 17:30	Bjorn Manuel HEGELICH, University of Texas		(*) Remote

Detailed Programme with Titles

DAY1

Agenda	IFAST Workshop on “Laser Drivers for Plasma Accelerators”, École Polytechnique, Palaiseau, Paris (FR), 20-22 April 2022
DAY 1	WEDNESDAY, April 20
09:30-10:00	OPENING –and IFAST overview Leonida A. GIZZI Intense Laser irradiation Lab, Istituto Nazionale di Ottica, CNR, Pisa Italy
10:00-10:30	Gérard MOUROU – Jonathan WHEELER IZEST, Ecole Polytechnique, Institut Polytechnique de Paris, France Title: “Toward Single cycle lasers for particle acceleration”
10:30-11:00	Coffee break and Group Picture – Day1
Chair	Roman WALCZAK
11:00-11:30	Sydney GALES Laboratoire de Physique des 2 infinis Irène Joliot-Curie, Orsay, France, and IFIN/ELI-NP, Romania Title: “Laser Driven versus “Classical “ Accelerators towards societal applications: Status and challenges”
11:30-12:00	Andreas R. MAIER Deutsches Elektronen-Synchrotron DESY, Hamburg, Germany Title: “Laser-Plasma Acceleration at DESY”
12:00-12:30	Kevin CASSOU Université Paris-Saclay, Centre Scientifique d’Orsay, France Title: “Advanced laser control for laser-plasma accelerators”
12:30-14:30	Lunch
Chair	Kevin CASSOU
14:30-15:00	Cameron G. R. GEDDES Accelerator Technology and Applied Physics Division, Lawrence Berkeley National Laboratory, Berkeley, USA Title: “Plasma accelerators and high average power lasers”
15:00-15:30	Roman WALCZAK John Adams Institute for Accelerator Science and Department of Physics, University of Oxford, UK Title: “GeV-scale accelerators driven by plasma-modulated pulses from kilohertz lasers”
15:30-16:00	Tea Break
Chair	Andreas R. MAIER
16:00-16:30	Jérôme FAURE Laboratoire d’Optique Appliquée Ecole Polytechnique – ENSTA – CNRS, France Title: “Recent progress and perspectives on high-repetition rate laser wakefield acceleration”
16:30-17:00	Francois SYLLA SourceLAB – Laser Plasma Technologies, Palaiseau, France Title: “SourceLAB, supplier of laser plasma accelerators”
17:00-17:30	Bjorn Manuel HEGELICH The University of Texas at Austin, USA Title: “Demonstration of high charge, >10 GeV laser wakefield acceleration and derived laser design considerations for accelerators and laser-driven XFELs”

All presentations available on the Workshop website: <http://ifast.pi.ino.cnr.it>

DAY 2

	THURSDAY, April 21
Chair	Leonida A. GIZZI
09:00-09:30	Mike CAMPBELL Laboratory for Laser Energetics, University of Rochester, New York 14623, USA Title: “Laser Drivers for Inertial Fusion Energy-Opportunities and Challenges”
09:30-10:00	Laura CORNER Cockcroft Institute for Accelerator Science and Technology, School of Engineering, The Quadrangle, University of Liverpool, United Kingdom Title: “Fibre lasers for plasma accelerators”
10:00-10:30	Bedrich RUS, ELI-Beamlines, Institute of Physics of the Czech Academy of Sciences, Prague 8, Czech Republic Title: “Development and operation of high-repetition rate drivers for proton and electron laser-plasma accelerators at ELI-Beamlines”
10:30-11:00	Franck FALCOZ/Stefane BRANLY Amplitude Technologies, Evry, France Title: “Roadmap to high energy, high average power pump laser”
11:00-11:30	Coffee break and Group photo – Day2 – Day2
Chair	Bedrich RUS
11:30-12:00	Ralph ASSMANN Deutsches Elektronen-Synchrotron (DESY) Title: “The EuPRAXIA Preparatory Phase Project”
12:00-12:30	Andrea KNIGGE Ferdinand-Braun-Institut Leibniz-Institut fuer Hoehstfrequenztechnik (FBH) Leibniz Inst Hochstfrequenztech, Berlin, GERMANY Title: “Research Progress in High Repetition Rate Diode Laser Pumps: Kilowatts at the Kilohertz”
12:30-13:00	Markus LÖSER Institute of Radiation Physics, Laser Particle Acceleration Division, Helmholtz-Zentrum Dresden – Rossendorf (HZDR), Germany Title: “Developing and exploiting high intensity laser driven particle and radiation sources at HZDR”
13:00-14:30	Lunch
Chair	Jérôme FAURE
14:30-15:00	Karoly OSVAY National Laser-Initiated Transmutation Laboratory at University of Szeged, Dugonics ter 13, Szeged, Hungary, Title: “Laser-generated neutrons for transmutation – physical schemes and laser requirements”
15:00-15:30	Leonida A. GIZZI Intense Laser irradiation Lab, Istituto Nazionale di Ottica, CNR, Pisa Italy Title: “Advancing the design of the EuPRAXIA laser”
15:30-16:00	Coffee break
16:00-17:30	ROUND TABLE – High average power accelerators for nuclear and medical uses. <i>To discuss laser needs of key applications with major development and high societal impact in the nuclear energy and medical fields with well focused sets of laser specs to drive accelerators, for medium and long term development.</i> With: Leonida A. GIZZI , Intense Laser irradiation Lab, Istituto Nazionale di Ottica, CNR, Pisa Italy, “Laser-driven VHEE FLASH” Bruno LE GARREC , Bruno Le Garrec, Apollon/LULI and LASYEX S.R.O., France “Laser efficiency and repetition rate” Ceferino OBCEMEA , National Cancer Research Institute Bethesda, MD, USA. “VHEE FLASH and new accelerator technologies” Karoly OSVAY , NLTL at University of Szeged, Dugonics ter 13, Szeged, Hungary, “Laser-generated neutrons for transmutation – physical schemes and laser requirements” Ishay POMERANTZ , The School of Physics and Astronomy, Tel Aviv University, Israel. “Optically Switchable MeV Ion/Electron Accelerator”

DAY2

DAY3

DAY 3 FRIDAY, April 22

Chair **Kevin CASSOU**

09:00-09:30 **Jonathan Tyler GREEN**

ELI Beamlines, Institute of Physics of the CAS, Czech Republic

Title: "[Development of L2-DUHA high repetition rate OPCPA-based LWFA driver laser](#)"

09:30-10:00 **Francois MATHIEU**

LULI-CNRS, CEA, Sorbonne Universite, Ecole Polytechnique, Institut Polytechnique de Paris, Palaiseau, France

Title: "[Apollon : how to improve Intensity stability on target](#)"

10:00-10:30 **Sandrine RICAUD**

Thales LAS France, Élancourt, France

Title: "[High average power TISa amplifier for 100Hz laser plasma accelerator](#)"

10:30-11:00 **Paul MASON**

Central Laser Facility, STFC Rutherford Appleton Laboratory, Didcot, Oxon, England

Title: "[Recent laser developments at the Central Laser Facility](#)"

11:00-11:30 **Coffee break**

Chair **Sandrine RICAUD**

11:30-12:00 **Federico CANOVA**

Extreme Light Infrastructure ERIC, Dolní Břežany, Czech Republic

Title: "[Update on the status of the Extreme Light Infrastructure \(ELI\) ERIC](#)"

12:00-12:30 **Luca LABATE**

Intense Laser irradiation Lab, Istituto Nazionale di Ottica, CNR, Pisa Italy

Title: "[kHz laser development with Tm-based ceramics](#)"

12:30-13:00 **Cedric THAURY**

Laboratoire d'Optique Appliquée, Ecole Polytechnique, ENSTA Paris, CNRS, Institut Polytechnique de Paris, Palaiseau, FRANCE

Title: "[Laser-Plasma Wave-Guides for Plasma Accelerators](#)"

13:00-13:15 **CLOSING**

13:15-14:30 **Lunch**

**All presentations available
on the Workshop website:
<http://ifast.pi.ino.cnr.it>**

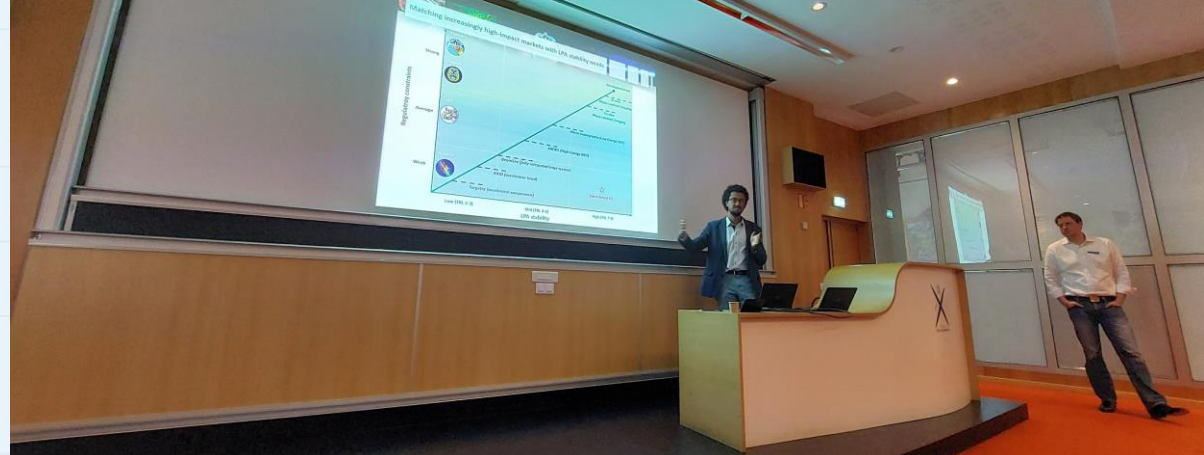

IFAST Laser Workshop (in presence), April 20-22, 2022, Palaiseau



52 registered participants in presence (max 52)

- >100 participants online
- >300 connections per day



IFAST Laser Workshop - Highlights



P-MoPA

History of Single-cycle Pulses

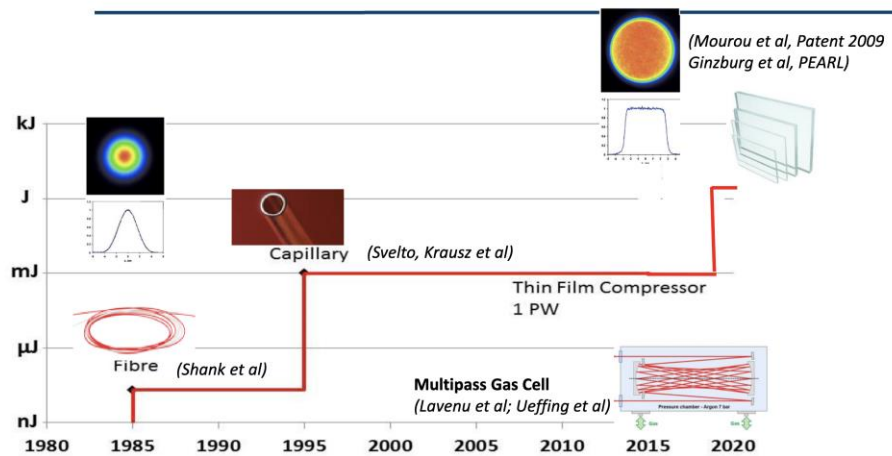

- ▶ Full scheme: Spectral-to-temporal modulation of a ps-duration pulse using low-energy seed pulse.

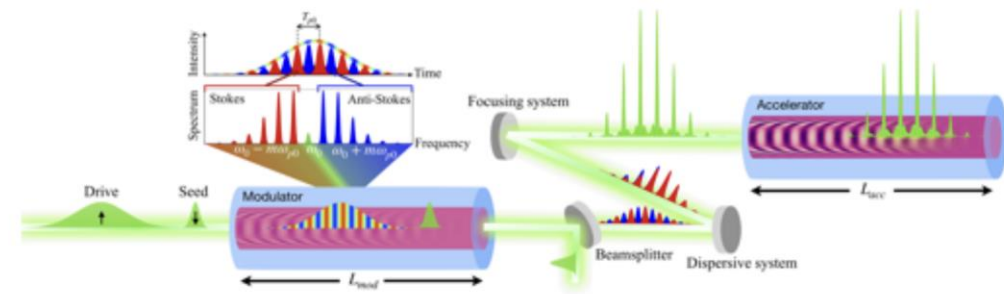

IFAST Workshop on "Laser Drivers for Plasma Accelerators" Roman Walczak
 École Polytechnique, Palaiseau, Paris, 20-22 April 2022 University of Oxford



Courtesy of
G rard MOUROU – Jonathan WHEELER
 IZEST, Ecole Polytechnique, Institut Polytechnique de Paris, France
Title: "Toward Single cycle lasers for particle acceleration"

Courtesy of
Roman WALCZAK
 John Adams Institute for Accelerator Science and Department of Physics, University of Oxford, UK
Title: "GeV-scale accelerators driven by plasma-modulated pulses from kilohertz lasers"



Expanding parameter range/applicability of existing lasers to LPA

IFAST Laser Workshop - Highlights

LUX Laser-Plasma Accelerator

Some Highlights

100,000 consecutive shots from a laser-plasma accelerator.

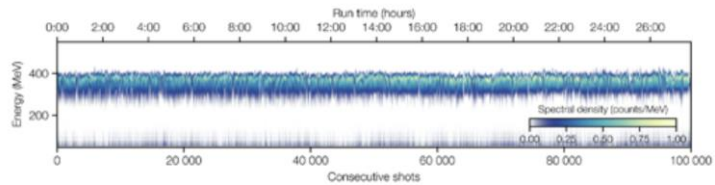

A.R. Maier et al. Phys. Rev. X 10, 031039 (2020)

Courtesy of
Andreas R. MAIER
 Deutsches Elektronen-Synchrotron DESY, Hamburg, Germany
 Title: "Laser-Plasma Acceleration at DESY"

5-Hour Hands-Off Operation



A. Vernier L. Rovige J. Huijts

12 M shots

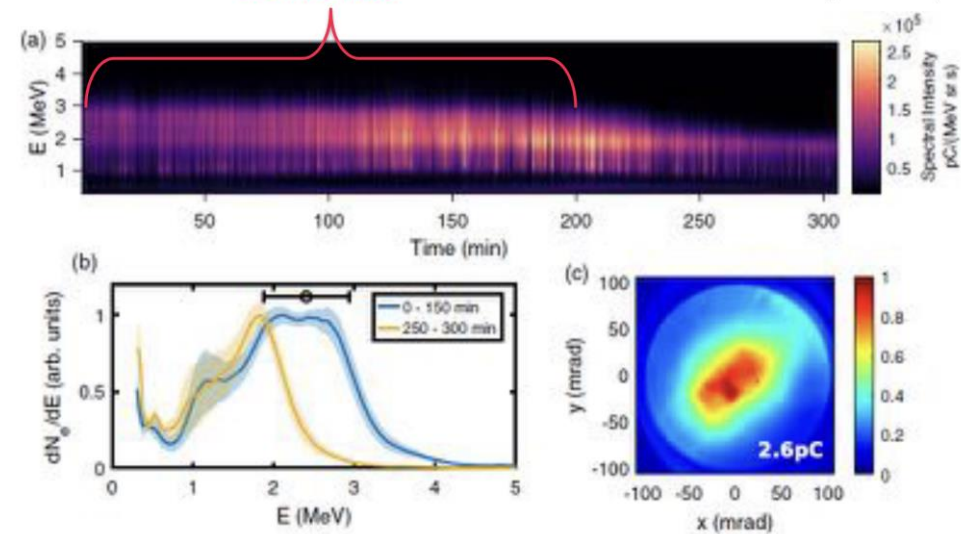

Courtesy of
Jérôme FAURE
 Laboratoire d'Optique Appliquée Ecole Polytechnique – ENSTA – CNRS, France
 Title: "Recent progress and perspectives on high-repetition rate laser wakefield acceleration"

Stable repetitive operation of LPA being established

IFAST Laser Workshop - Highlights

Mapping of Amplitude Ns Advanced Lasers & expected roadmap to higher average power

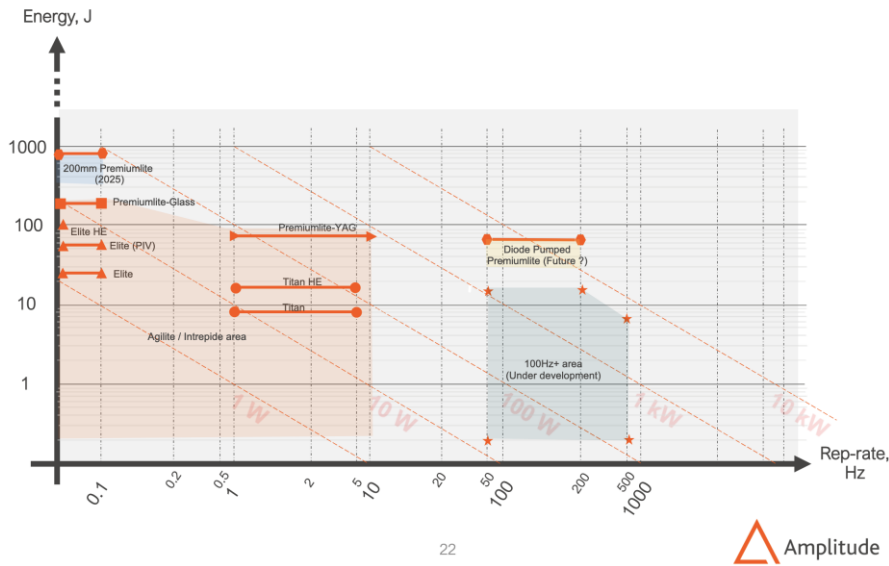

22

THICK DISK TISA PUMPED BY THEIA LASER : 5 HOURS OPERATION 1/100 PULSES

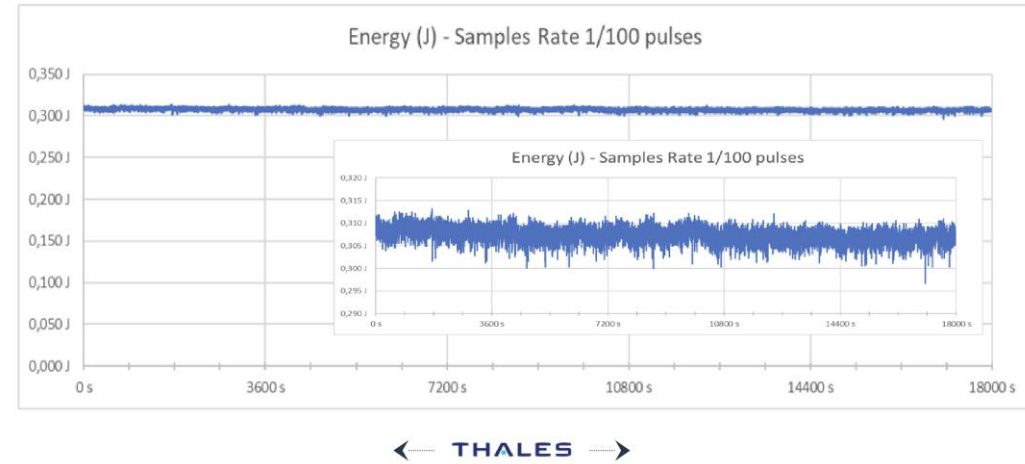

Courtesy of
Franck FALCOZ/Stefane BRANLY
 Amplitude Technologies, Evry, France
 Title: "Roadmap to high energy, high average power pump laser"

Courtesy of
Sandrine RICAUD
 Thales LAS France, Élancourt, France
 Title: "High average power TiSa amplifier for 100Hz laser plasma accelerator"



Industrial roadmap matching required developments

IFAST Laser Workshop - Highlights



Spectral characteristics

Comparison: Diode vs. Rainbow

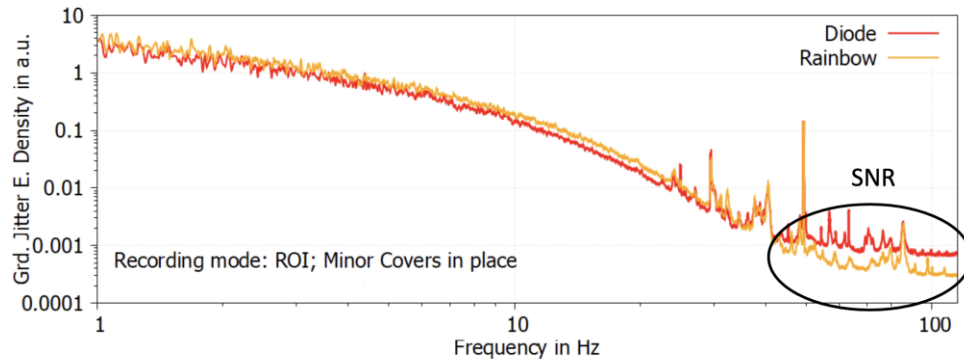

Courtesy of

Francois MATHIEU

LULI-CNRS, CEA, Sorbonne Universite, Ecole Polytechnique, Institut Polytechnique de Paris, Palaiseau, France

Title: "Apollon : how to improve Intensity stability on target"



Addressing design issues for future systems (e.g. EuPRAXIA)



AMPLIFICATION MODULES: CONCEPTUAL LAYOUT



Two possible solutions envisaged, determined by thermal management considerations

Common features:

- gas cooling found to be insufficient at the given power density
- face cooling of gain elements by water flow (longitudinal cooling)
- gain volume split in some sub-elements to increase cooling surface
- multi-step pumping for parasitic laser management

1 – Multipass amplification scheme in transmission

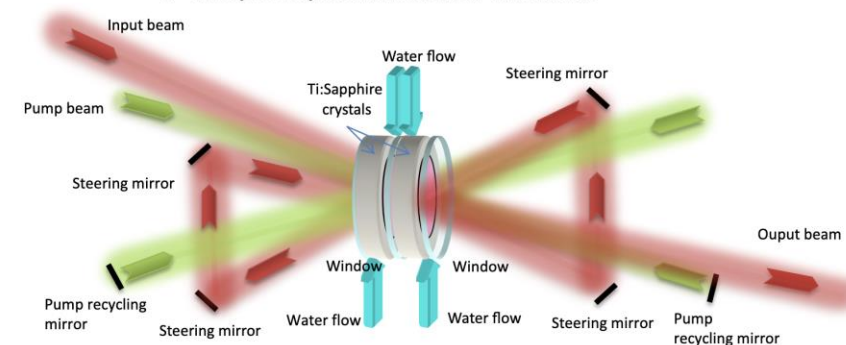

Double side, double pass pumping

Crystal split in 2 elements, face cooled by water flow, to increase cooling surface

Multipass amplification (4 to 6 depending on stages)

Absorption layer on crystal sides for parasitic lasing suppression



17

Leonida A. GIZZI

Intense Laser irradiation Lab, Istituto Nazionale di Ottica, CNR, Pisa Italy

Title: "Advancing the design of the EuPRAXIA laser"

L.A. Gizzi, IFAST Workshop "Laser drivers for plasma accelerators", Palaiseau, 20-22 April, 2022

IFAST Laser Workshop - Highlights

Thermal management: general params/architecture

- Active medium parameters**
- Density: 9.33 g/cm^3
 - Specific heat capacity: $c_p = 0.24 \text{ J/gK}$
 - Thermal conductivity: $k = 12.3 \text{ W/mK}$
 - Intensity: $\approx 0.6 \text{ J/cm}^2$

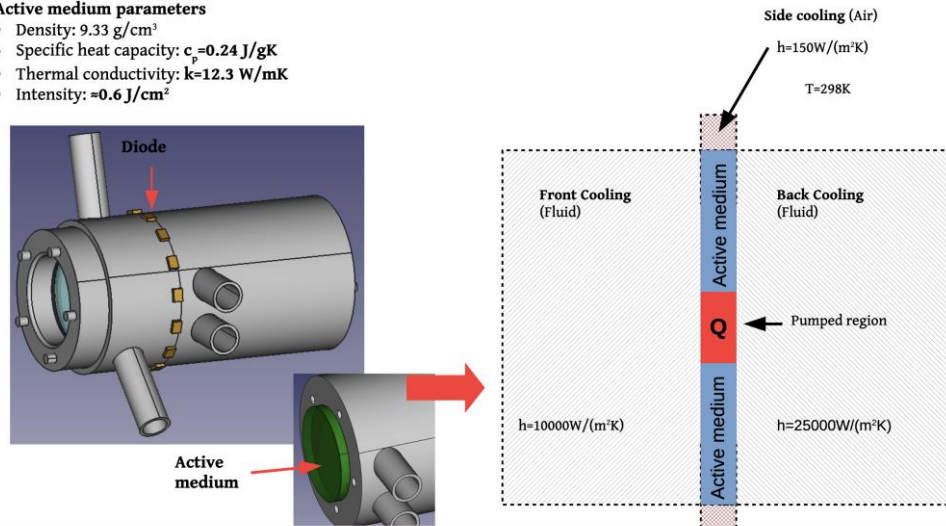

Thermal management: results for amplifier 3

Luca LABATE
 Intense Laser irradiation Lab, Istituto Nazionale di Ottica, CNR, Pisa Italy
Title: “kHz laser development with Tm-based ceramics”



L2-DUHA Laser

High Repetition rate 20 – 50 Hz, 100 TW laser with an auxiliary mid-IR output designed for driving LWFA

The core technology of the laser relies on Yb:YAG DPSSL-pumped OPCPA

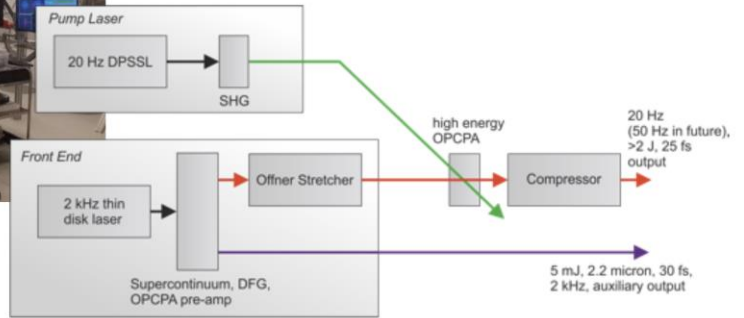

Courtesy of
Jonathan Tyler GREEN
 ELI Beamlines, Institute of Physics of the CAS, Czech Republic
Title: “Development of L2-DUHA high repetition rate OPCPA-based LWFA driver laser”



Develop of new efficient lasers at higher repetition rate

IFAST Laser Workshop - Highlights

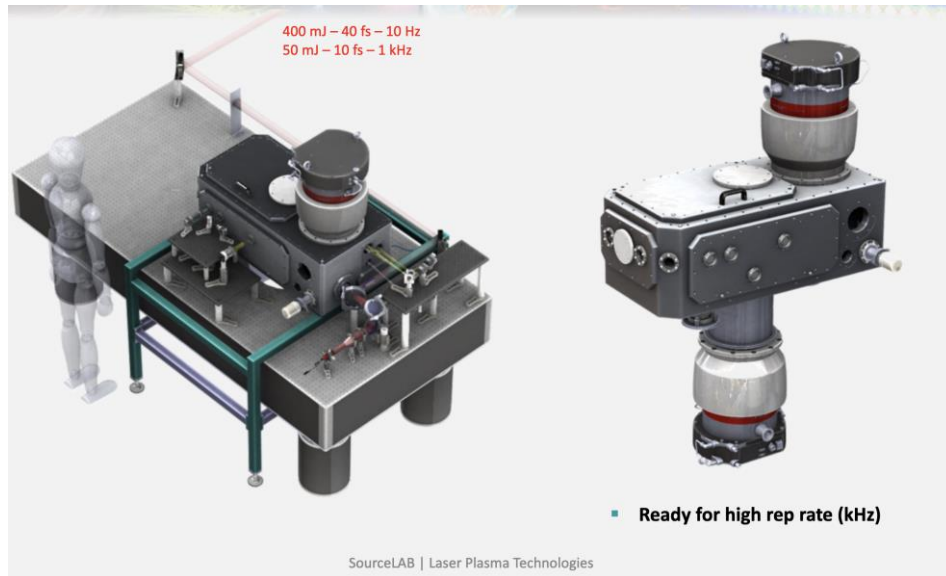

Higher power & efficiency from conventional bars → lower €/W

Cost and power per bar, diode laser pumps for CW disk lasers

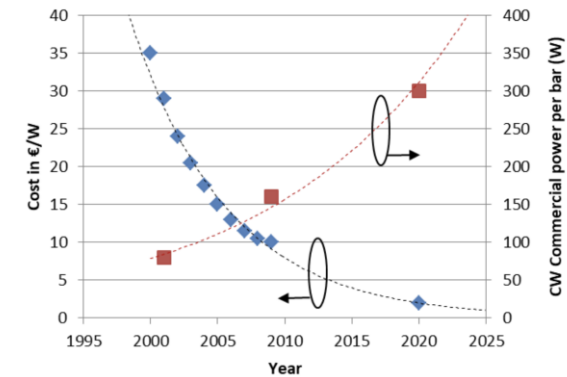

Sources:
 H.G. Treusch *et al.* IEEE J Sel. Top. Quant. Electron. 6(4), p. 601 (2000)
 G. Bonati Laser Techn. Journal 2, p. 37 (2010)
 S.G. McDougall *et al.* Proc SPIE 11262, paper 5 (2020)



Courtesy of
Francois SYLLA
 SourceLAB – Laser Plasma Technologies, Palaiseau, France
Title: “SourceLAB, supplier of laser plasma accelerators”

Courtesy of
Andrea KNIGGE
 Ferdinand-Braun-Institut Leibniz-Institut fuer Hoehstfrequenztechnik
 (FBH) Leibniz Inst Hochstfrequenztech, Berlin, GERMANY
**Title: “Research Progress in High Repetition Rate Diode Laser Pumps:
 Kilowatts at the KiloHertz”**



Industrial, ready to use, laser/acceleration technology

Workshop takeaway messages

New and major laser-based facilities progressing fast and going online

- ELI facilities now operational with strong industrial involvement (Amplitude, Thales ...)
- New facilities paving the way to full industrial exploitation or high quality LPA (EPAC, Kaldera ...)

Key Labs delivering novel results and repetitive operation of LPA with quality and stability

- Demonstration of multiple hours of continuous operation (Desy, LOA, IJClab, LBNL ...)
- Novel LPA concepts for exploitation of industrial grade existing lasers (Oxford)
- Exciting results on laser-plasma wave guiding for extended acceleration length (LOA)
- 10 GeV record electron energy (Texas PW) with high charge
- Compact industrial accelerator head being delivered (SOURCELab)
- Beam pointing, stability and control engineering (Apollon)

Laser developments addressing high repetition rate and high efficiency

- High average power development taking place at industrial partners (Amplitude, Thales ...)
- New development platforms for high efficiency Thulium based (LLNL, CNR, Jena)
- Fiber lasers coherent combination evolving rapidly (see L. Corner review and LBNL)
- Important synergy possible with Inertial Fusion Laser developments (see M. Campbell talk)
- EuPRAXIA laser design going technical (See L. Gizzi talk)

Major cases for applications (see also round table presentations)

- Preclinical in vivo tumor studies towards FLASH (HZDR)
- VHEE approaching FLASH ready with HRR laser driver (CNR, LOA others ...)
- Applications with X-rays and neutron for industry and energy (EPAC, NLTL ...)
- ...

Collaborative space

Collaboration Workspaces

BROWSE PAGE



WP6 **Task 6.2** [EDIT LINKS](#)

Task 6.2

Home

Notebook

Documents

Site Contents

[EDIT LINKS](#)

Lasers for Plasma Acceleration (LASPLA)

Task Leader: L. Gizzi (CNR)

SUMMARY

Establish a roadmap to foster delivery of advanced industrial laser drivers with high repetition rate and higher efficiency, for the first user laser-plasma based accelerators.

Establish a coordination activity with networking and training of main laser labs, focused on laser-drivers R&D

MS22 - LASPLA Workshop/School [M30] - Report

D6.2 - LASPLA Strategy [M46] - Strategy for laser drivers for plasma accelerators

Newsfeed

Start a conversation



la.gizzi@gmail.com

All files of the 2nd meeting have been uploaded

13 October Like Reply ...



la.gizzi@gmail.com

The files of the 2nd Technical Meeting of Task 6.2 (LASPLA) are being uploaded. See Readme file for info and agenda of the meeting.

12 October Like Reply ...



la.gizzi@gmail.com

All files of the 1st Technical Meeting of Task 6.2 (LASPLA) have been uploaded. See Readme file for info and agenda of the meeting.

17 August Like Reply ...

[SHOW MORE POSTS](#)

Documents

[+ new document](#) or drag files here

- ✓ Name
- Readme_Agenda of 2nd IFAST_LASPLA Tech Meeting ...
- LASPLA_2nd_Tech_meeting_G.Andrianaki ...
- LASPLA_2nd_Tech_meeting_T.Spinka ...
- LASPLA_2nd_Tech_meeting_L.Labate ...
- LASPLA_2nd_Tech_meeting_L.Roso ...
- LASPLA_2nd_Tech_meeting_L.A.Gizzi ...
- LASPLA_2nd_Tech_meeting_V.Malka ...
- LASPLA_2nd_Tech_meeting_J.Hein ...
- LASPLA_2nd_Tech_meeting_A.R.Maier ...
- LASPLA_2nd_Tech_meeting_R.Walczak ...
- Readme_Agenda of 1st IFAST_LASPLA Tech Meeting ...
- LASPLA_1st_Tech_meeting_G.Toci ...
- LASPLA_1st_Tech_meeting_C.Simon-Boisson ...
- LASPLA_1sr_Tech_meeting_L.Labate ...
- LASPLA_1sr_Tech_meeting_P.Mason ...

1 - 15 [▶](#)



https://espace.cern.ch/project-IFAST-Intranet/_layouts/15/start.aspx/

Task 6.2 overview

- **Towards D6.2 : LASPLA Strategy [M46] - Strategy for laser drivers for plasma accelerators:**
 - Update survey of existing/developing laser technologies, including next-in-line industrial products; **in progress**
 - List against TRL of components and architectures; **on track**
 - Identify key needed collaborative developments; **on track**
 - R&D funding opportunities for labs/facilities; **on track**
- **Towards MS22 - LASPLA Workshop/School [M30]:**
 - Start preparation of the first LASPLA related workshop (18-22 April, 2022, tbc); **done ✓**
 - Secure participation and scientific contribution to EAAC 2022/2023; **in progress**
 - Training programme for LPA laser-driver development (Capri Summer School (tbd)); **in progress**

Summary

- IFAST Lasers for Plasma Acceleration Task 6.2 (and 6.4) on track
- Network established and further growing, with high participation to Wshops
- Technical discussion focusing on needed solutions for plasma accelerators



Innovation Fostering in
Accelerator Science and
Technology

HOME ABOUT ▾ WORK PACKAGES ▾ RESULTS ▾ INDUSTRY ▾ NEWS ▾ ARIES CONTACT

I.FAST & Industry

The involvement of industry as a co-innovation partner is crucial to achieve the I.FAST project's ambitious goals

Thank you

la.gizzi@ino.cnr.it
la.gizzi@gmail.com



This project has received funding from the European Union's Horizon 2020 Research and Innovation programme under GA No 101004730.