

TESTING THE PAULI EXCLUSION PRINCIPLE WITH THE VIP-2 EXPERIMENT AND BEYOND

*Fabrizio Napolitano on behalf of the VIP-2
Collaboration*

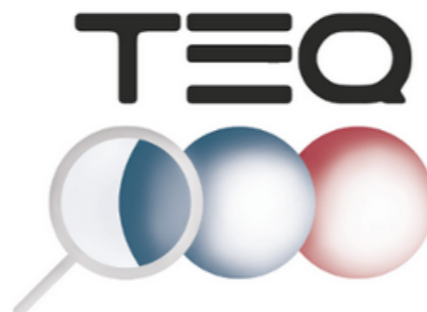

fabrizio.napolitano@lnf.infn.it

XI International Conference on New Frontiers in Physics

The Pauli Exclusion Principle

In an atom there cannot be two or more equivalent electrons for which the values of all four quantum numbers coincide. If an electron exists in an atom for which all of these numbers have definite values, then the state is occupied.

W. Pauli, Über den Zusammenhang des Abschlusses der Elektronengruppen im Atom mit der Komplexstruktur der Spektren, Zeitschrift für Physik 31 (1925) 765.

Pauli Archive, holding: fierz_0092-064

Physikalisches Institut
der Eidg. Technischen Hochschule
Zürich

ZÜRICH 7.
Oktober 1949

Lieber Herr Fierz,

Heute würde ich Sie als Kenner von **Leibniz** empfehlen.
 Herr Weyl hat mir ^{an} vorhin eine englische, ~~von~~ durch mehrere
 Appenzauer herübergebrachte Ausgabe eines früheren Aufsatzes
 ("Philosophie von Hakt. o. Mg.") im Handbuche der Philosophie
 geschickt. Im Appendix B, p. 247 ^{heißt Weyl} ~~findet sich~~ das
 Ausschließungsprinzip mit **Leibniz** in Zusammenhang
 und zwar mit dem "principium identitatis
indivisibilitatis". Das klingt aber viel zu philologisch.



The Pauli Exclusion Principle (PEP)

Spin-statistic connection:

half-integer spin particles → antisymmetric wave function & Fermi-Dirac stat

Integer spin particles → symmetric wave function & Bose statistics

Lüders and Zumino: spin-statistics lays on few, general assumption:

Lorentz/Poincaré Symmetry, CPT, unitarity, locality & causality

Theories of Statistics Violation

O.W. Greenberg: AIP Conf.Proc.545:113-127,2004

“Possible external motivations for violation of statistics include: (a) violation of CPT, (b) violation of locality, (c) violation of Lorentz invariance, (d) extra space dimensions, (e) discrete space and/or time and (f) non-commutative spacetime.....”

The Pauli Exclusion Principle (PEP)

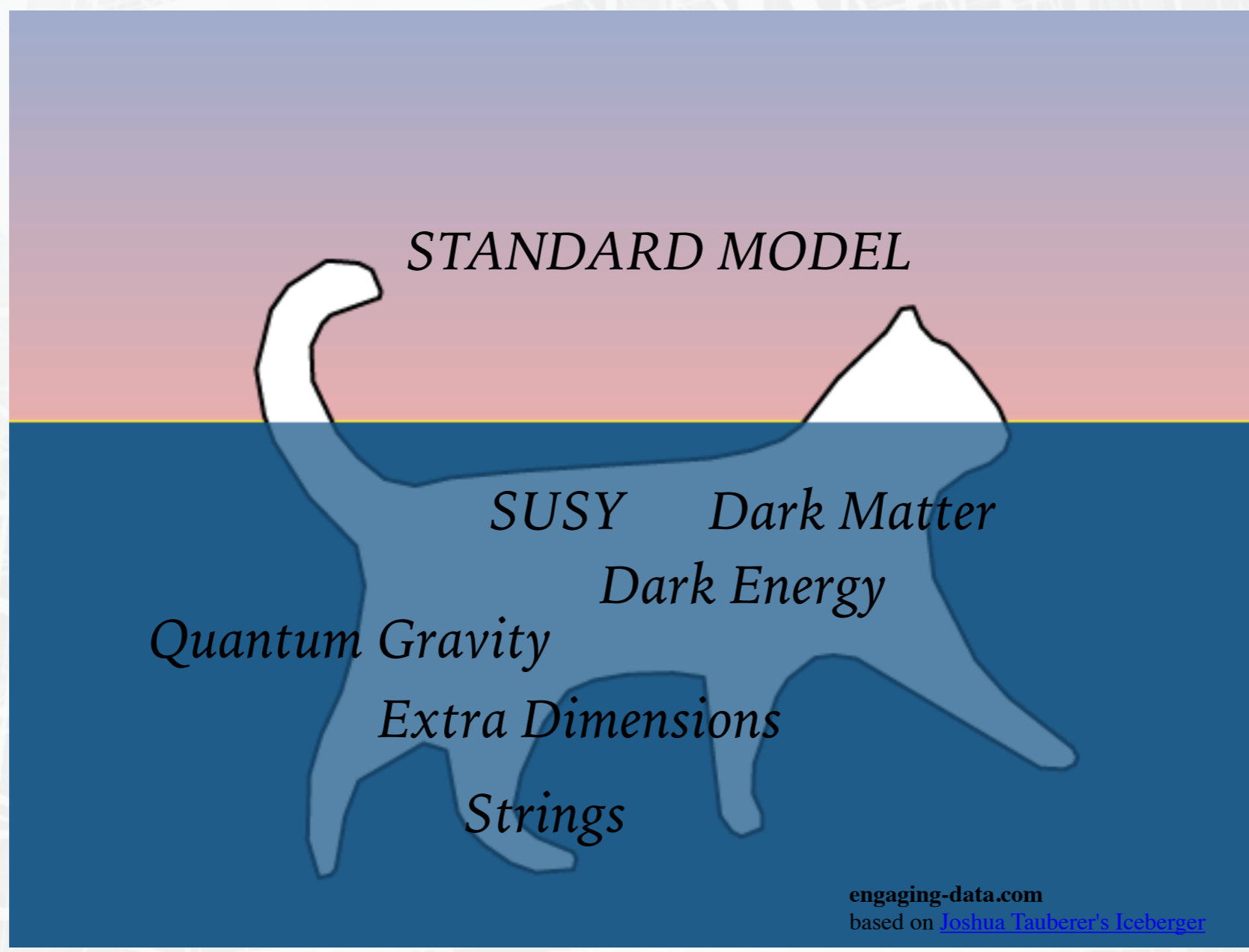

engaging-data.com
based on [Joshua Tauberer's Iceberger](#)

The Pauli Exclusion Principle (PEP)

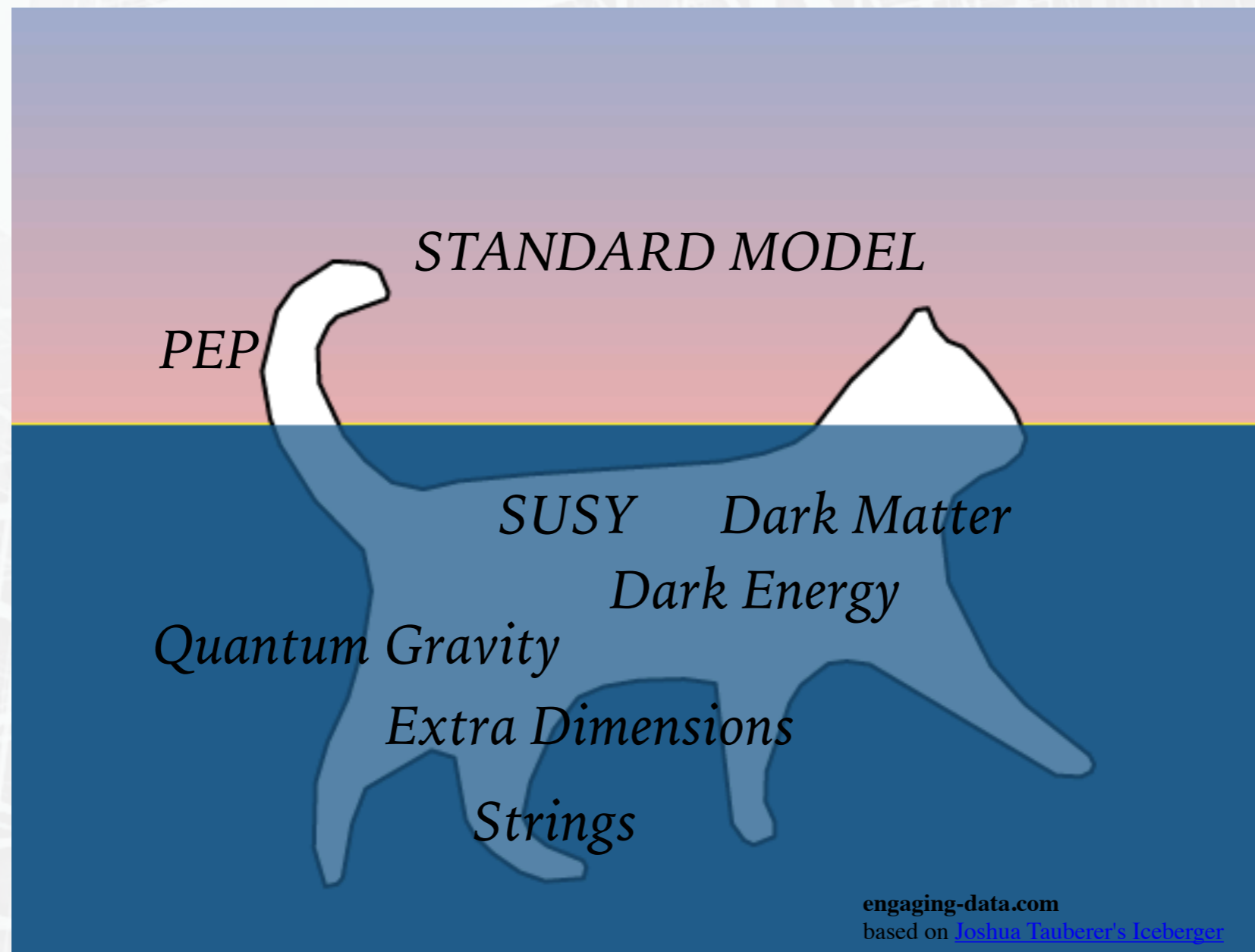

BSM theories embedding extra dimensions, non commutative and/or discrete spacetime could have effect on PEP

How to model PEP violations

- *Ignatiev & Kuzmin model: Fermi oscillator with a third state*

(Ignatiev, A.Y., Kuzmin, V. , *Quarks '86: Proceedings of the 229 Seminar, Tbilisi, USSR, 1517 April 1986*)

$$\begin{array}{ll}
 a^+|0\rangle = |1\rangle & a|0\rangle = 0 \\
 a^+|1\rangle = \beta|2\rangle & a|1\rangle = |0\rangle \\
 a^+|2\rangle = 0 & a|2\rangle = \beta|1\rangle
 \end{array}$$

β quantifies the degree of violation in the transition

- *Greenberg & Mohapatra: Local Quantum Field Theory, q parameter deforms anticommutators [Phys. Rev. Lett. 1987,59,2507]:*

$$a_k a^+ l - q a^+ l a_k = \delta_{k,l}$$

- *Rahal & Campa: global wave function of the electrons not exactly antisymmetric, PEP holds as long as the number of wrongly entangled pairs is small*

All respect the Messiah-Greenberg super-selection rule!

Messiah-Greenberg super-selection rule:

Superposition of states with different symmetry are not allowed \rightarrow

Transition probability between two symmetry states is ZERO

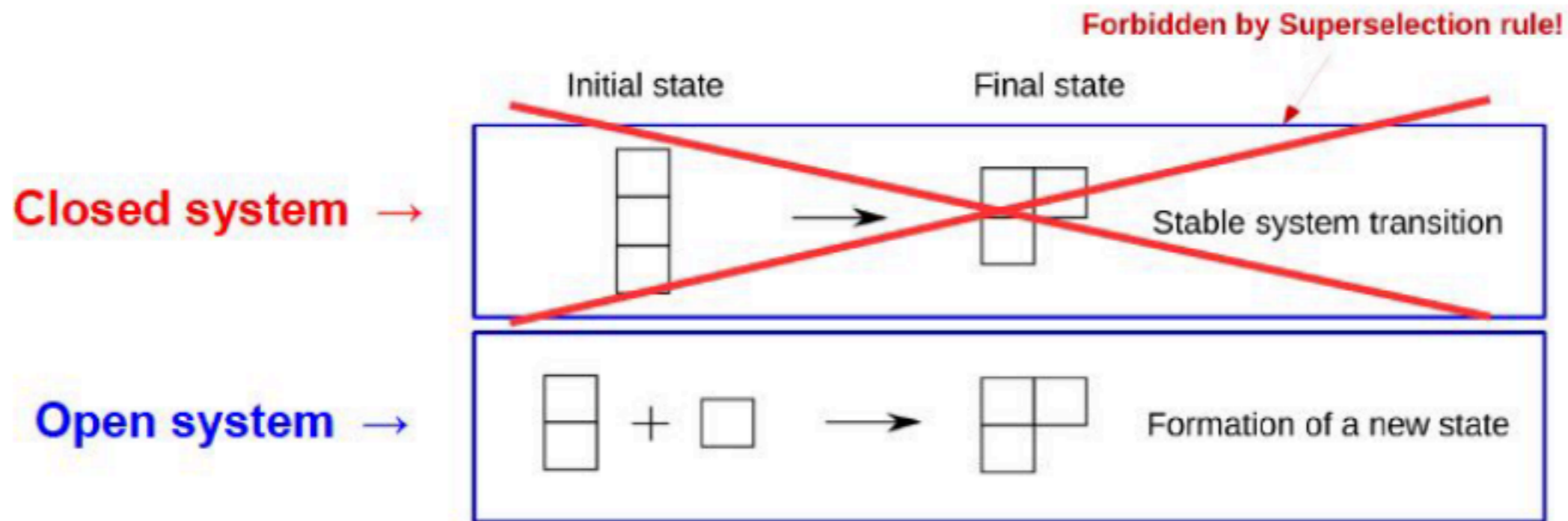

VIP-2 Experiment: best limits on PEP violation of an elementary particle respecting the Messiah-Greenberg super-selection rule

Search for anomalous X-ray transitions performed by electrons introduced in a target *through a DC current (open system)*

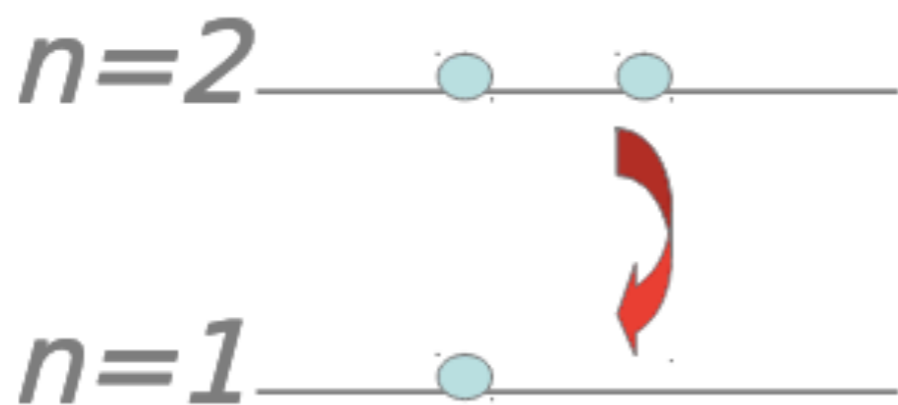

Normal $2p \rightarrow 1s$ transition

~ 8.05 keV in Cu

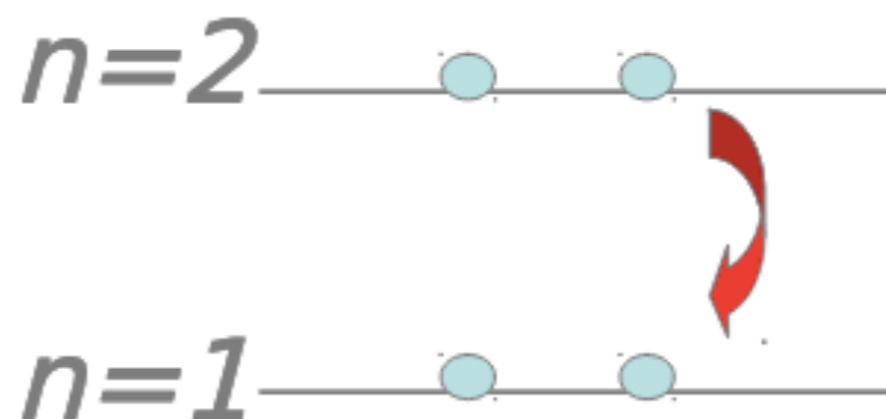

$2p \rightarrow 1s$ transition violating Pauli principle

~ 7.7 keV in Cu

Paul Indelicato (Ecole Normale Supérieure et Université Pierre et Marie Curie)

Multiconfiguration Dirac-Fock approach

Accounts for the shielding of the two inner electrons

Greenberg, O. W. & Mohapatra, R. N., Phys Rev Lett 59, (1987).
E. Ramberg and G. A. Snow, Phys Lett B 238, 438-441(1990)

**Search for anomalous electronic transitions in Cu
 induced by a circulating current**

**introduced electrons interact with the valence electrons
 search transition from 2p to 1s already filled by 2 electrons
 alternated to X-ray background measurements without current**

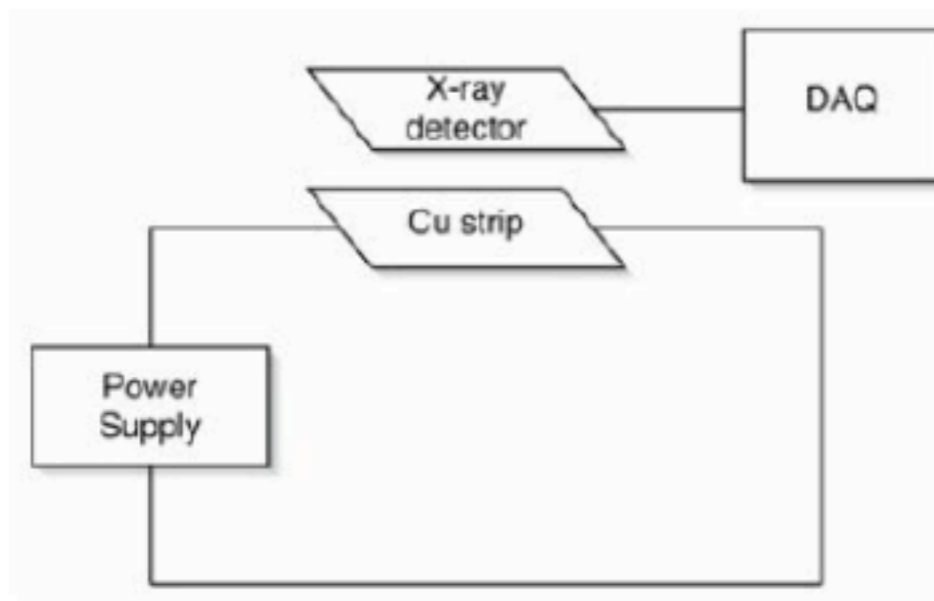

PEP Violation Signal:

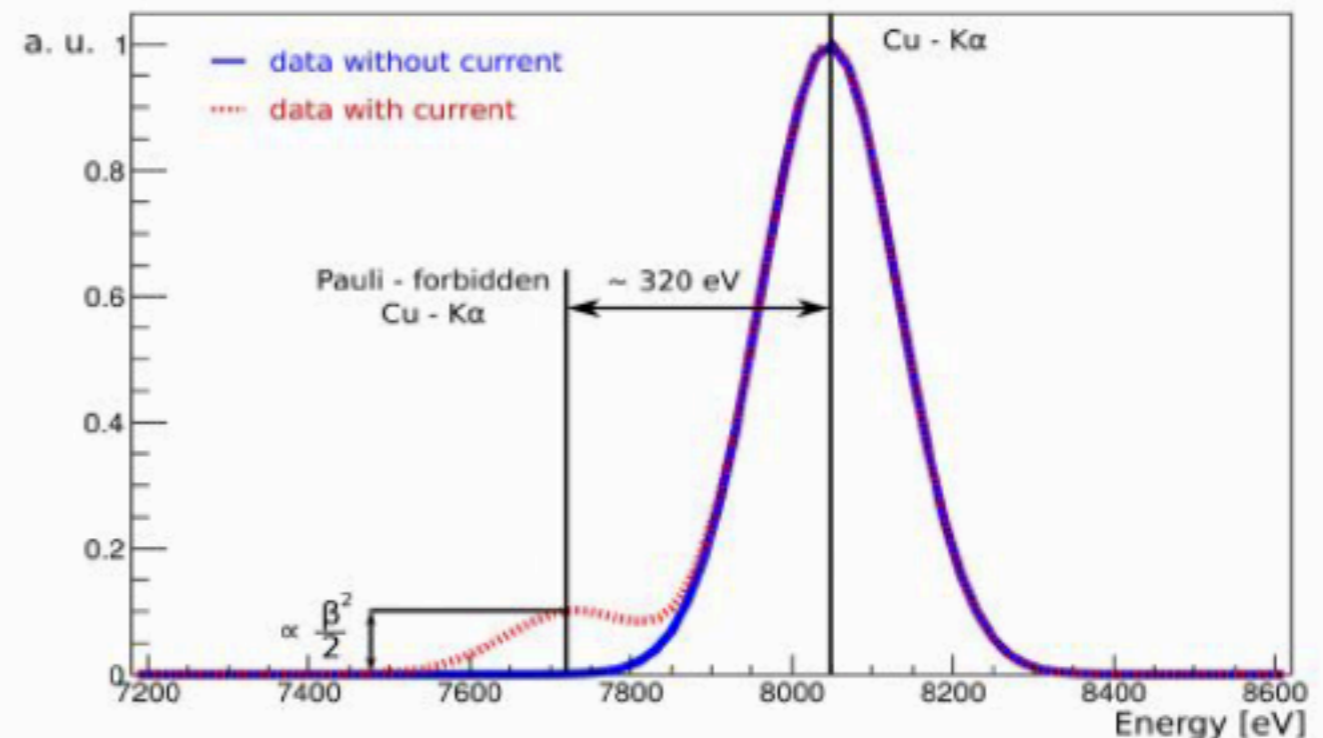

From VIP to VIP-2

- copper ultrapure cylindrical foil
- surrounded by 16 Charge Coupled Devices (CCD) res. at 8 keV 320 eV (FWHM)
- inside a vacuum chamber: CCDs cooled to 168K by a cryogenic system
- amplifiers + read out ADC boards.

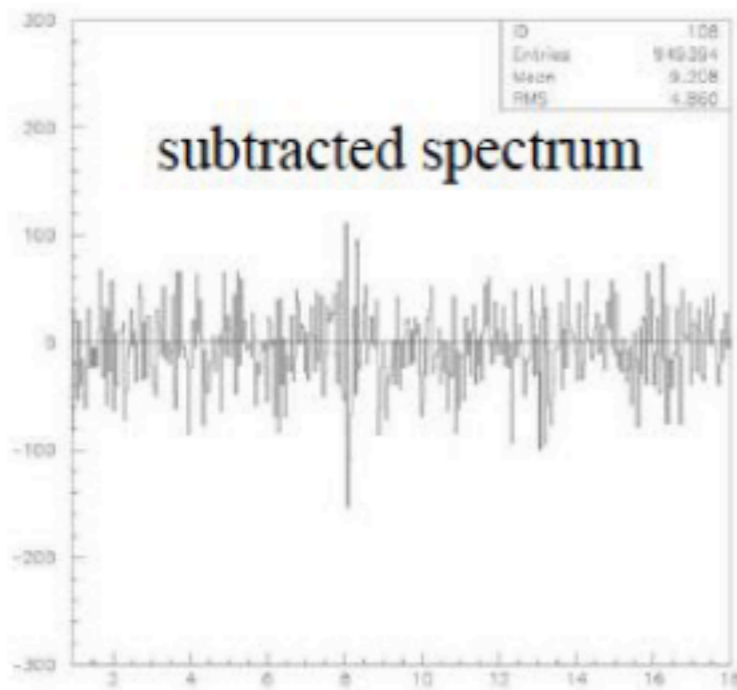
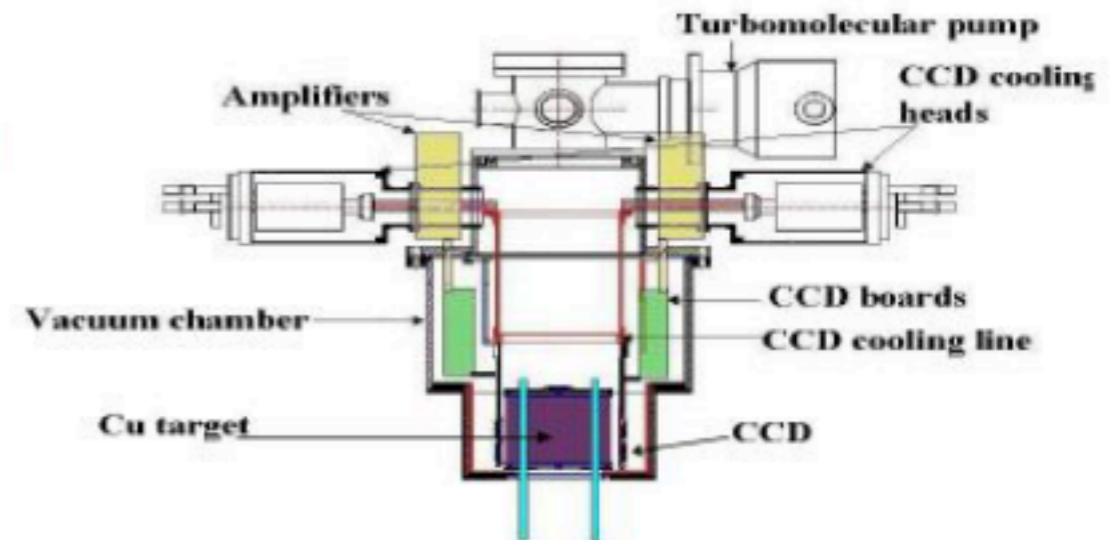

$$\beta^2/2 \leq 4.7 \times 10^{-29}$$

*improved the limit obtained by Ramberg & Snow
by a factor ~ 400*

(Foundation of Physics 41 (2011) 282+ other papers)

**GOAL OF VIP-2 : improve the VIP result of 2
orders of magnitude**

The VIP-2 Experiment

Silicon Drift Detectors (SDDs) higher resolution (190 eV FWHM at 8.0 \rightarrow keV), faster (triggerable) detectors. 4 arrays of 2 x 4 SDDs 8mm x 8mm each, liquid argon closed circuit cooling 170 °C

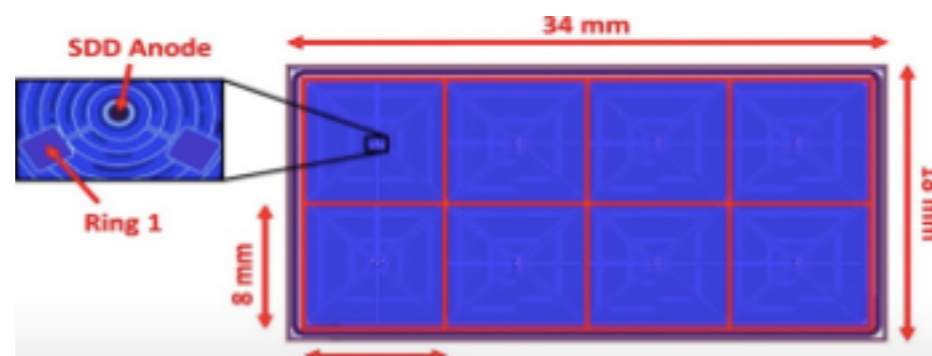
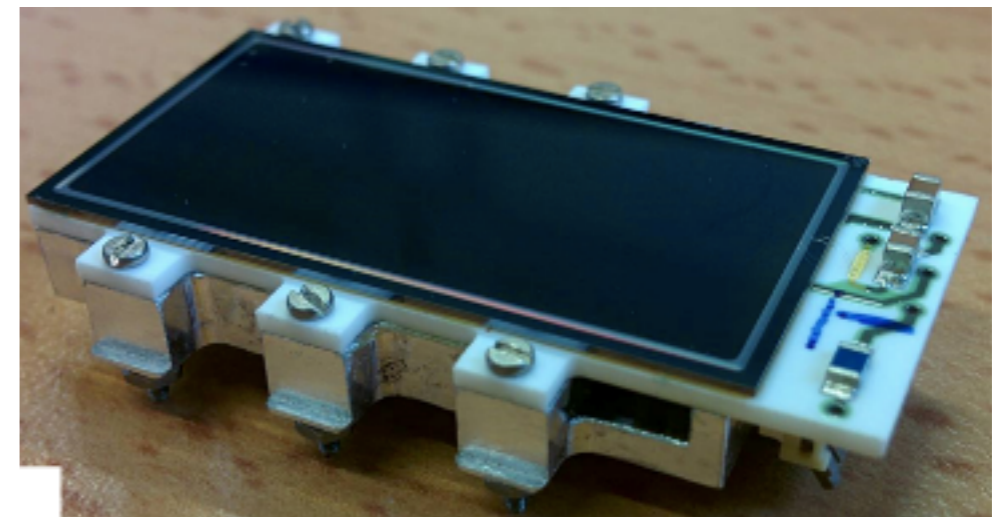
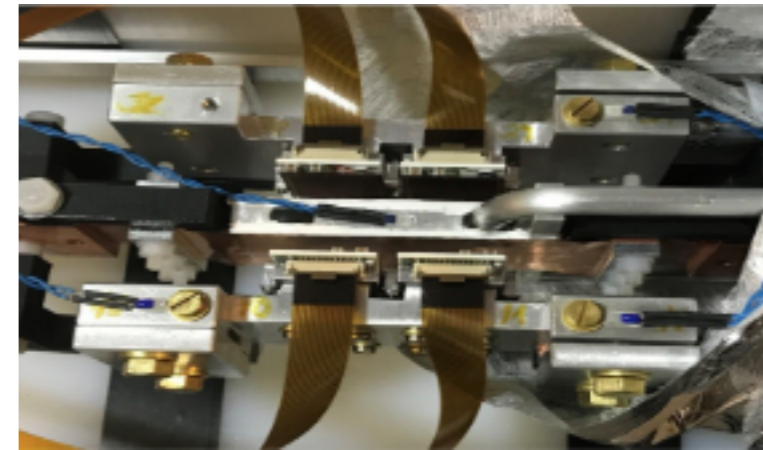
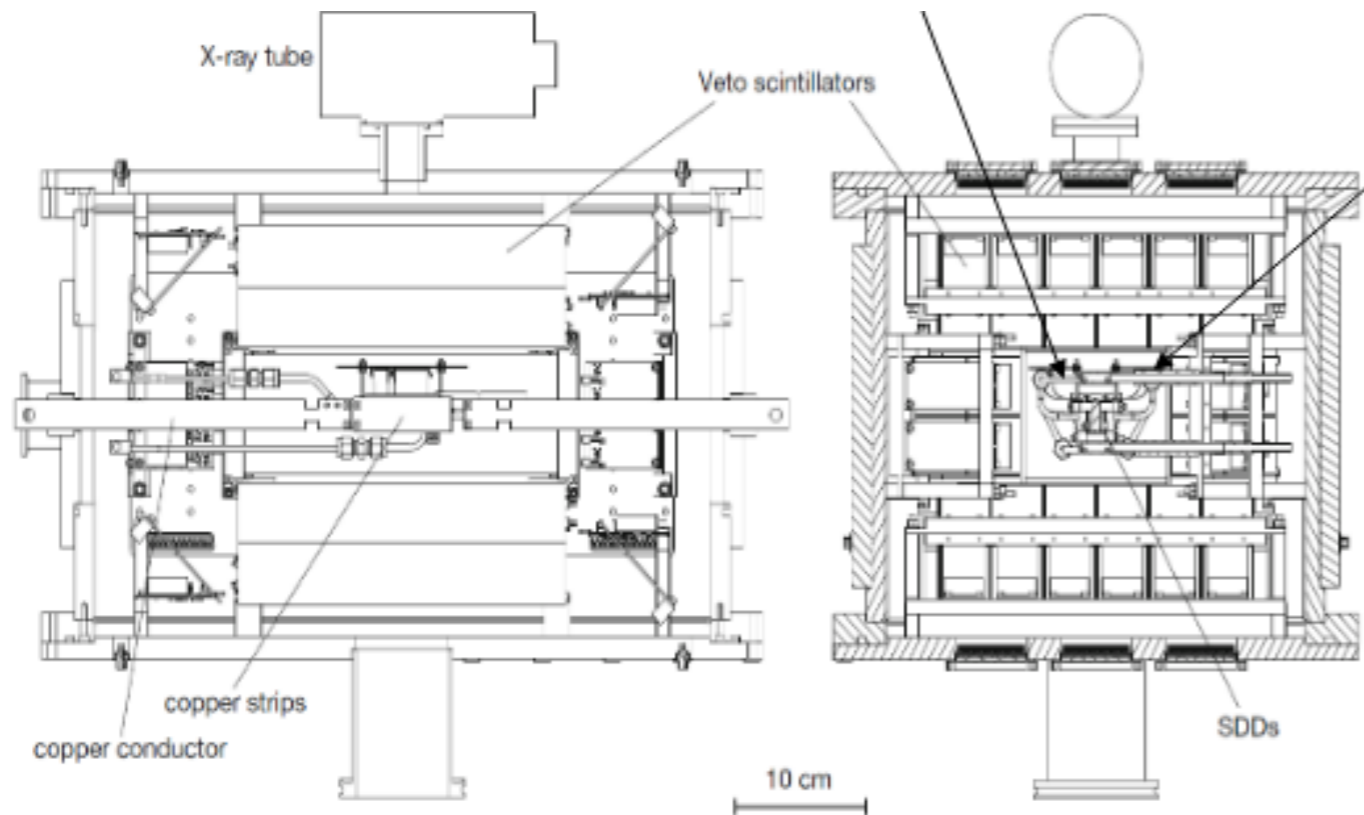

The VIP-2 Experiment

2 strip shaped Cu targets (25 μm x 7 cm x 2 cm) more compact target \rightarrow higher acceptance, thinner \rightarrow higher efficiency

DC current supply to Cu bars

Cu strips cooled by a closed Fryka chiller circuit \rightarrow higher current (100 A) @ 20 $^{\circ}\text{C}$ of Cu target implies 1 $^{\circ}\text{K}$ heating in SDDs

Sketch of the VIP2 Setup:

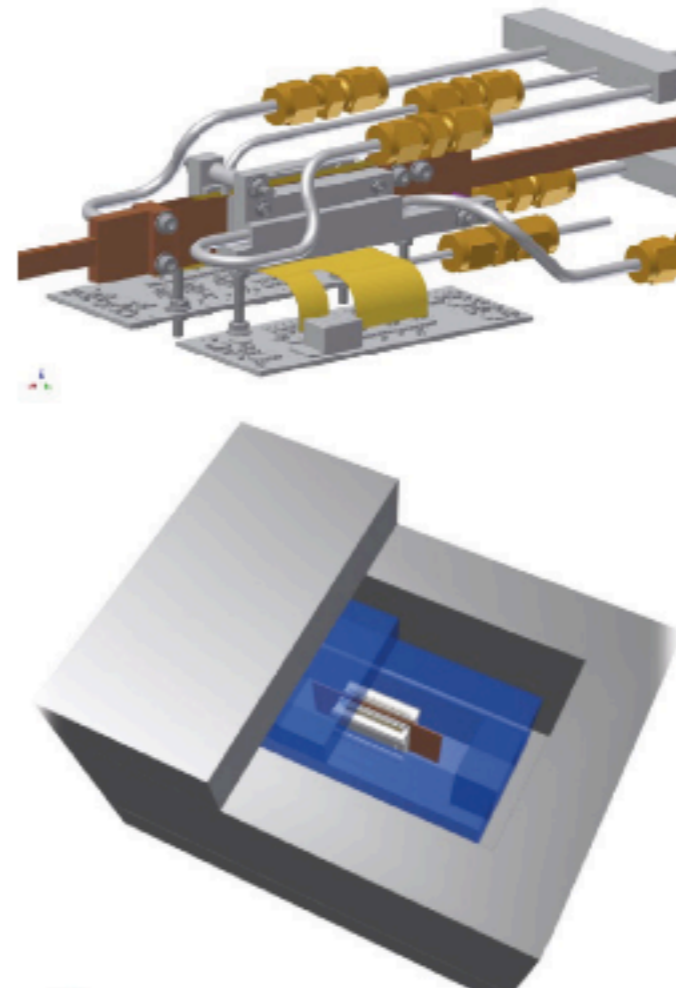
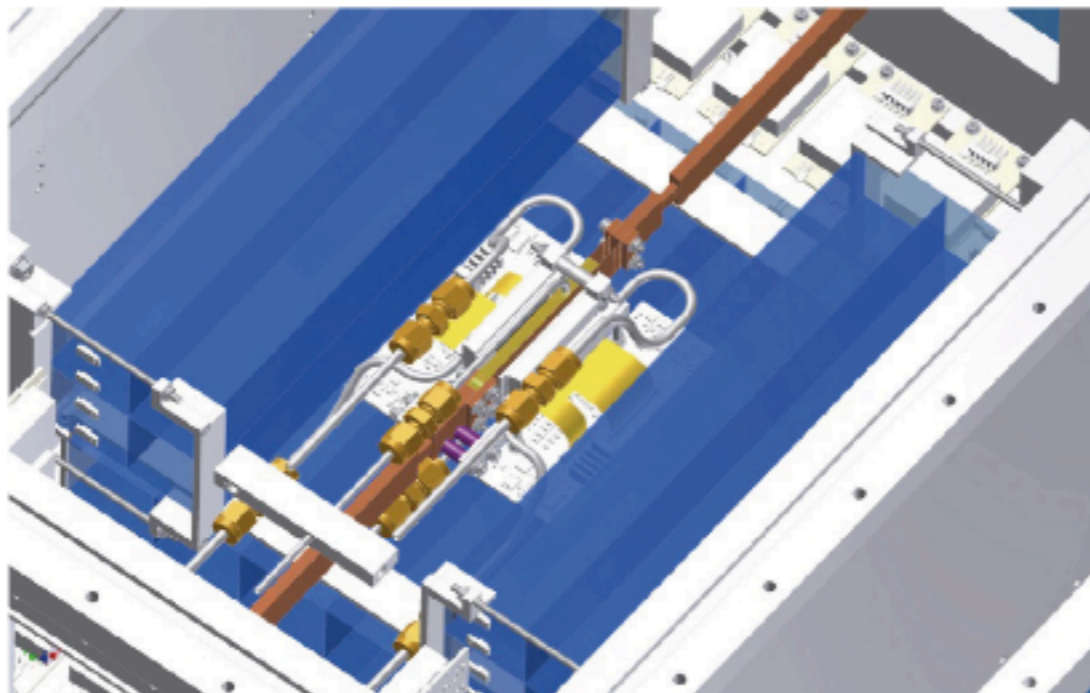

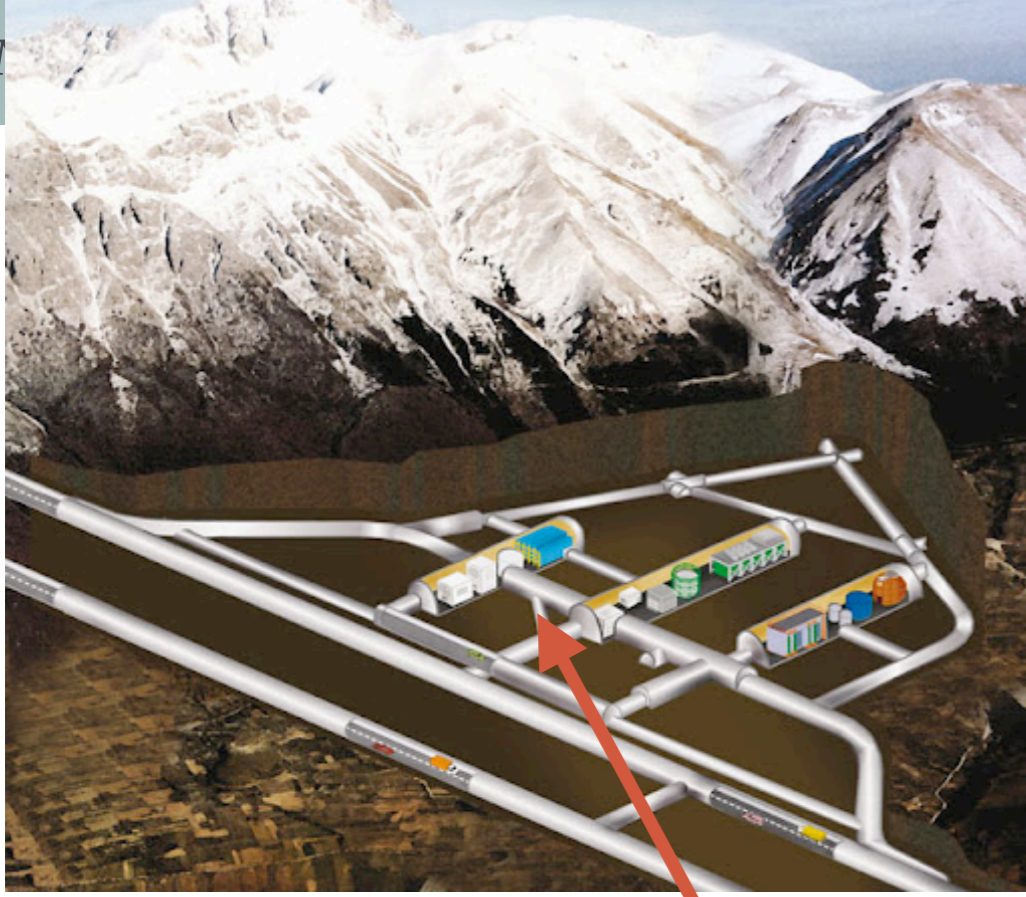

1400 m rock coverage

Upgrade concluded in April 2019:

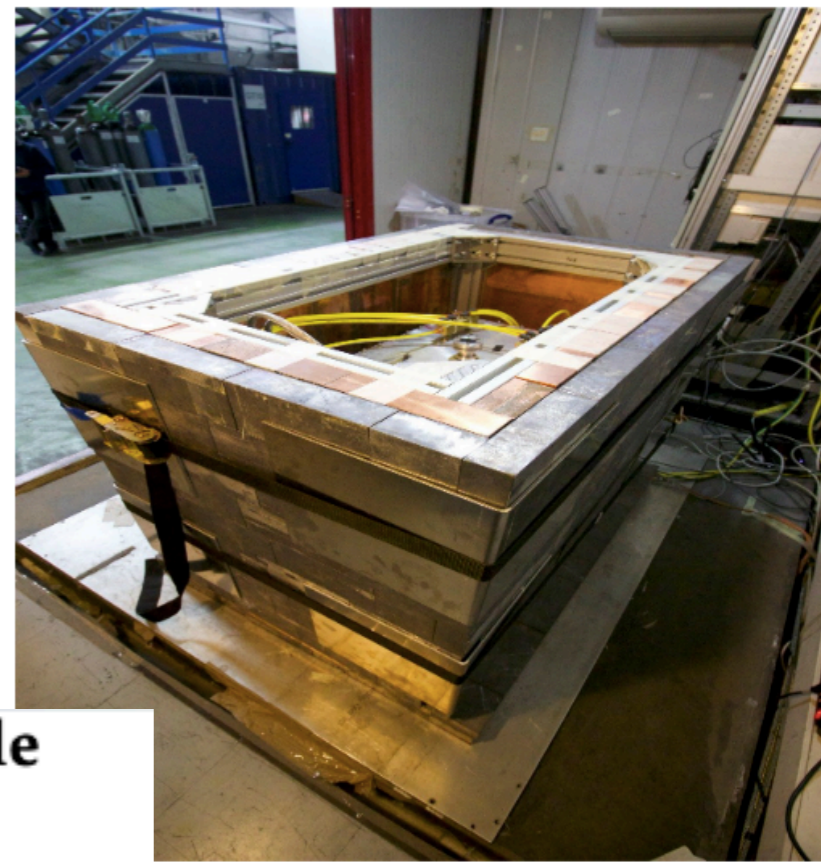

Passive shielding → two layers, copper inside lead outside

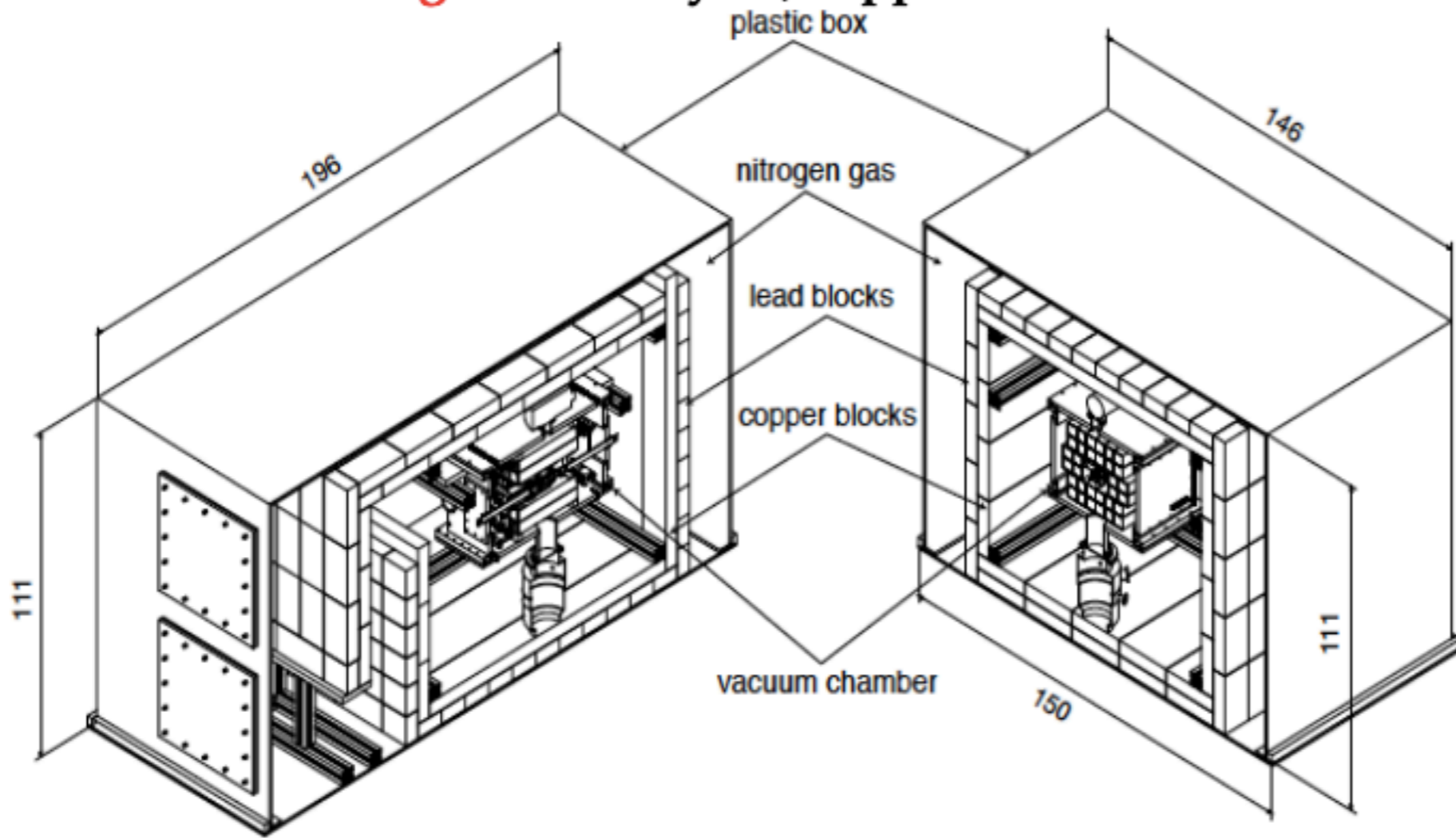

Symmetry **2022**, *14*(5), 893;
<https://doi.org/10.3390/sym14050893>

Six months of data taking

VIP-2 Experiment

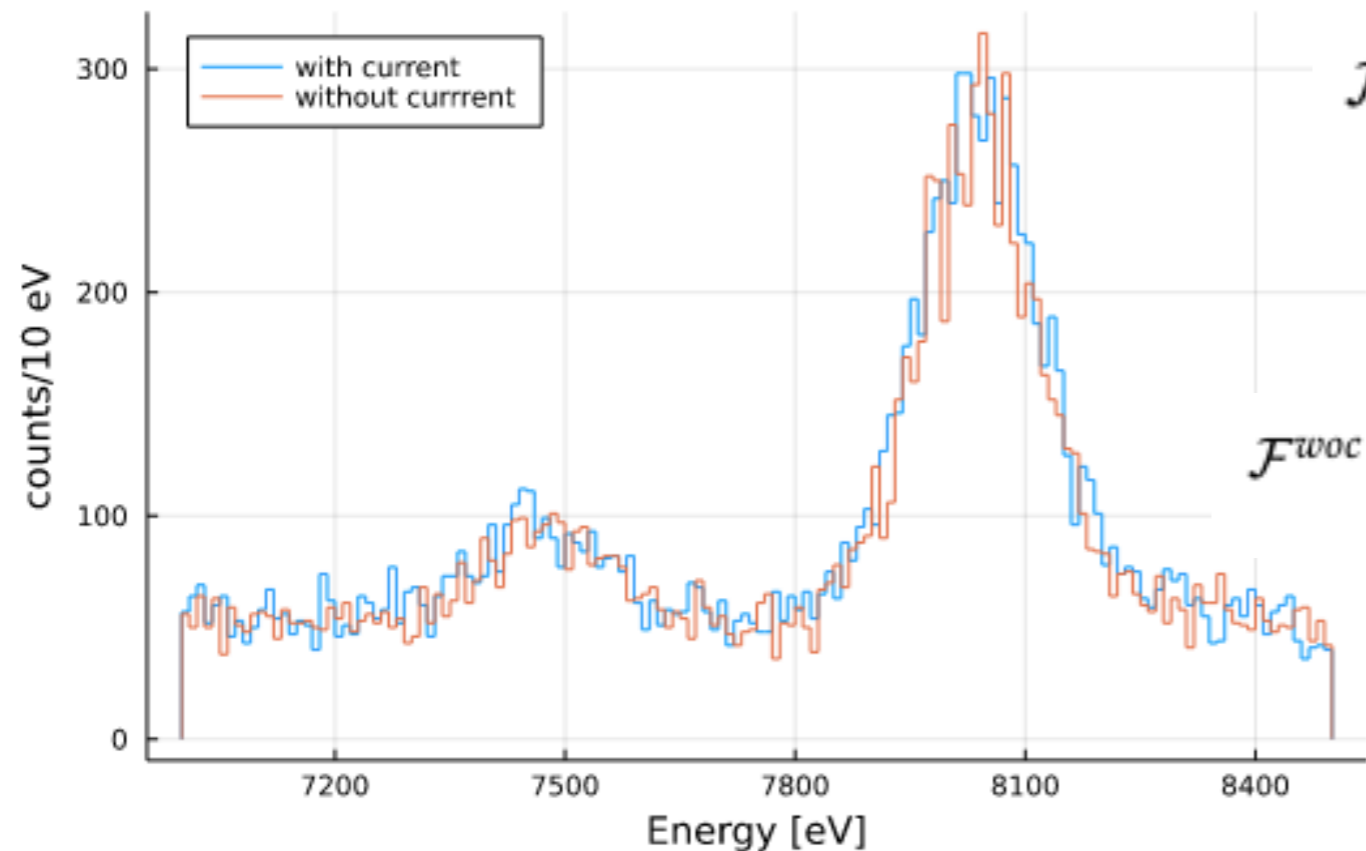

Description spectrum with current

$$\mathcal{F}^{wc}(\boldsymbol{\theta}, \mathbf{y}, \mathcal{S}) = y_1 \times Ni(\theta_1, \theta_2) + y_2 \times Cu(\theta_3, \theta_4) + y_3 \times pol_1(\theta_5) + \mathcal{S} \times PEPV(\theta_4)$$

Description spectrum without current

$$\mathcal{F}^{woc}(\boldsymbol{\theta}, \mathbf{y}) = y_1 \times Ni(\theta_1, \theta_2) + y_2 \times Cu(\theta_3, \theta_4) + y_3 \times pol_1(\theta_5)$$

Likelihood

$$\mathcal{L}(\mathcal{D}^{wc}, \mathcal{D}^{woc} | \boldsymbol{\theta}, \mathbf{y}, \mathcal{S}) = \text{Poiss}(\mathcal{D}^{wc} | \mathcal{F}^{wc}(\boldsymbol{\theta}, \mathbf{y}, \mathcal{S})) \times \text{Poiss}(\mathcal{D}^{woc} | \mathcal{F}^{woc}(\boldsymbol{\theta}, \mathbf{y} \times \mathcal{R}))$$

Bayesian

$$p(\boldsymbol{\theta}, \mathbf{y}, \mathcal{S} | \mathcal{D}^{wc}, \mathcal{D}^{woc}) =$$

$$= \frac{\mathcal{L}(\mathcal{D}^{wc}, \mathcal{D}^{woc} | \boldsymbol{\theta}, \mathbf{y}, \mathcal{S}) p(\boldsymbol{\theta}, \mathbf{y}, \mathcal{S})}{\int d\boldsymbol{\theta} d\mathbf{y} \mathcal{L}(\mathcal{D}^{wc}, \mathcal{D}^{woc} | \boldsymbol{\theta}, \mathbf{y}, \mathcal{S}) p(\boldsymbol{\theta}, \mathbf{y}, \mathcal{S})}$$

Frequentist

$$t_{\mathcal{S}} = -2 \ln \Lambda(\mathcal{S}) = -2 \ln \frac{\mathcal{L}(\hat{\boldsymbol{\theta}}, \hat{\mathbf{y}}, \mathcal{S})}{\mathcal{L}(\hat{\boldsymbol{\theta}}, \hat{\mathbf{y}}, \hat{\mathcal{S}})}$$

$$p_{\mathcal{S}} = \int_{t_{obs}}^{\infty} f(t_{\mathcal{S}} | \mathcal{S}) dt_{\mathcal{S}}$$

Symmetry **2022**, *14*(5), 893;
<https://doi.org/10.3390/sym14050893>

Bayesian

Frequentist

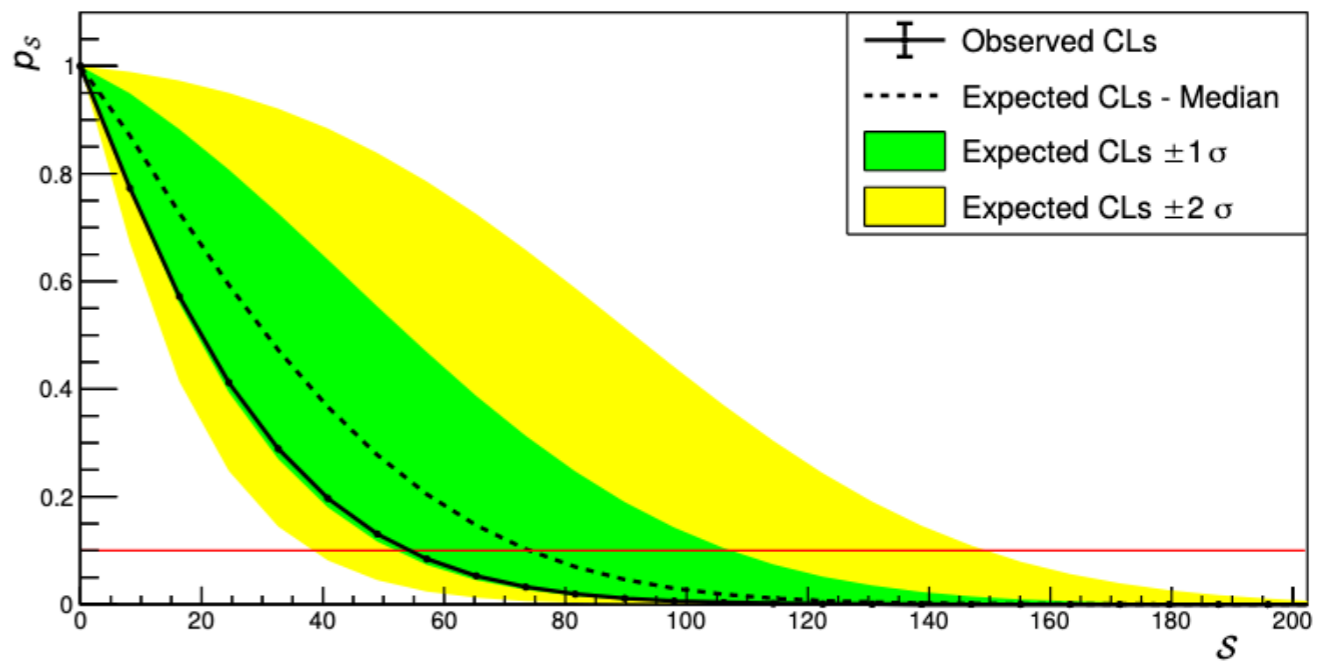
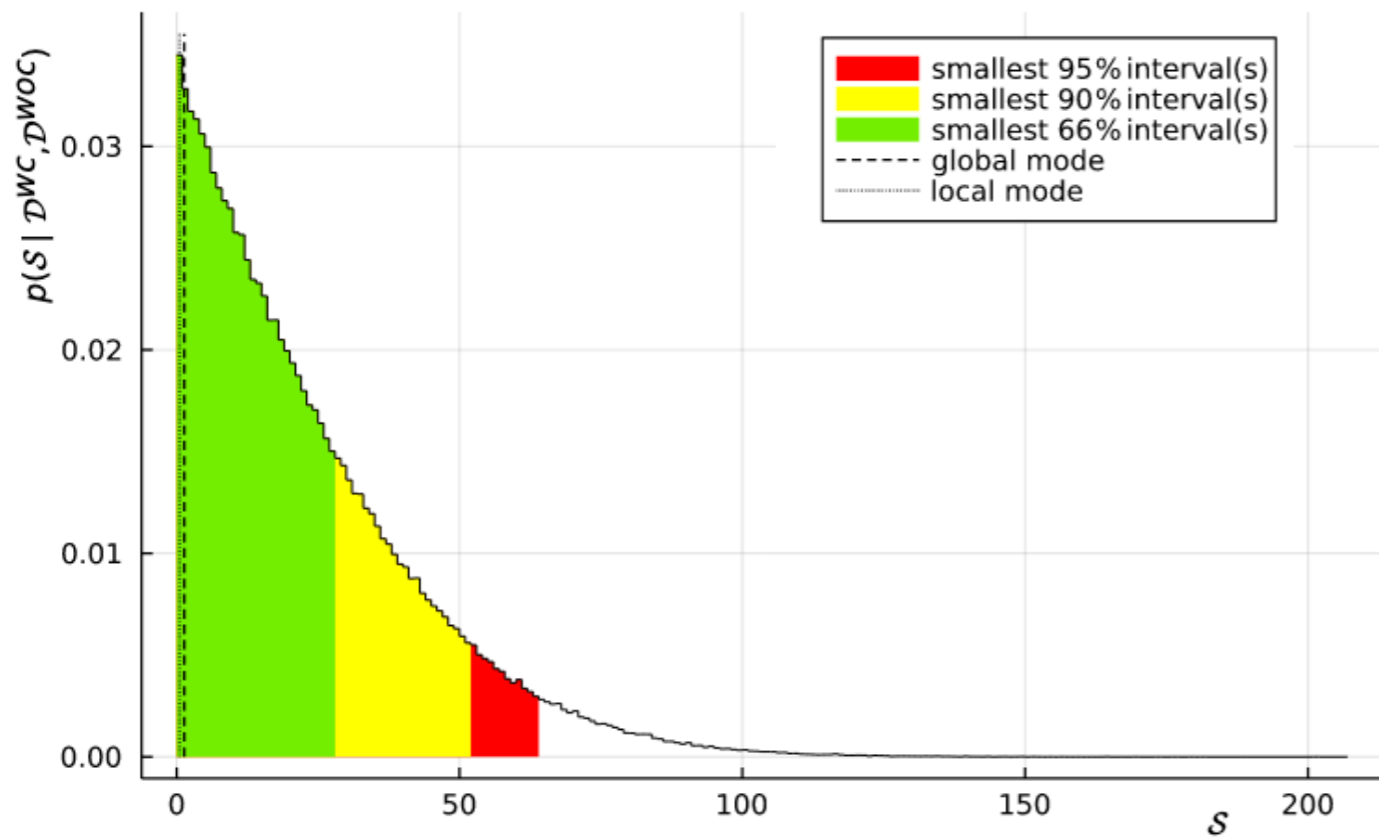

$$\beta^2 / 2 \leq 8.6 \times 10^{-31} \text{ (Bayesian),} \quad \beta^2 / 2 \leq 8.9 \times 10^{-31} \text{ (CL}_s\text{)}$$

New article in preparation with all the available statistics!

VIP-2 experimental upgrade: VIP-3

Scan the PEP violation probability as a function of Z (i.e. of Energy)

Okun, L.:

“The special place enjoyed by the Pauli principle in modern theoretical physics does not mean that this principle does not require further and exhaustive experimental tests. On the contrary, it is specifically the fundamental nature of the Pauli principle which would make such tests, over the entire periodic table, of special interest”

**L. Possible violation of the Pauli principle in atoms. JETP Lett.
1987, 46, 529532**

**“High sensitivity Pauli Exclusion Principle tests by the VIP experiment:
status and perspectives”**

Paper on the preparation of VIP-3 experiment accepted in APPA.

VIP-2 experimental upgrade: VIP-3

- new vacuum chamber, increase the number of SDD detectors, increase the geometrical efficiency, higher current up to 400 A
- New thermal contact between cold finger and SDDs
- New target cooling system
- Higher quantum efficiency needed for the SDDs at higher Z: use 1 mm thick SDDs, allowing to scan e.g. Ag, Sn and Pd

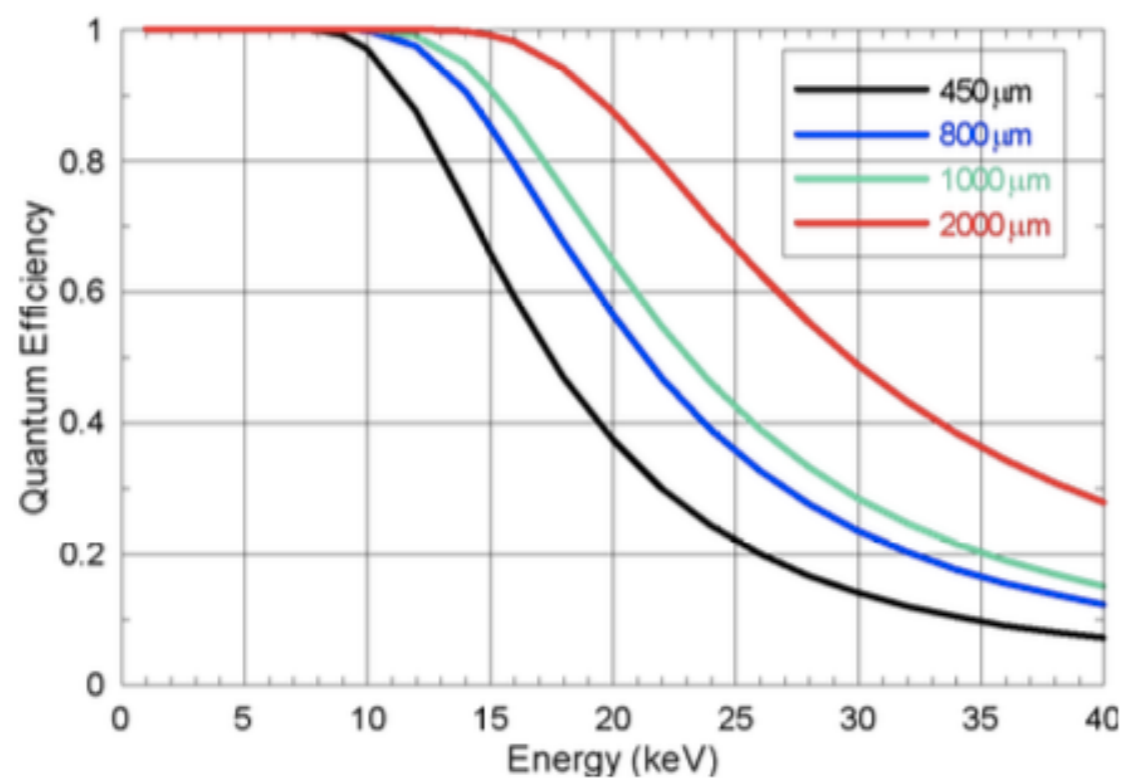
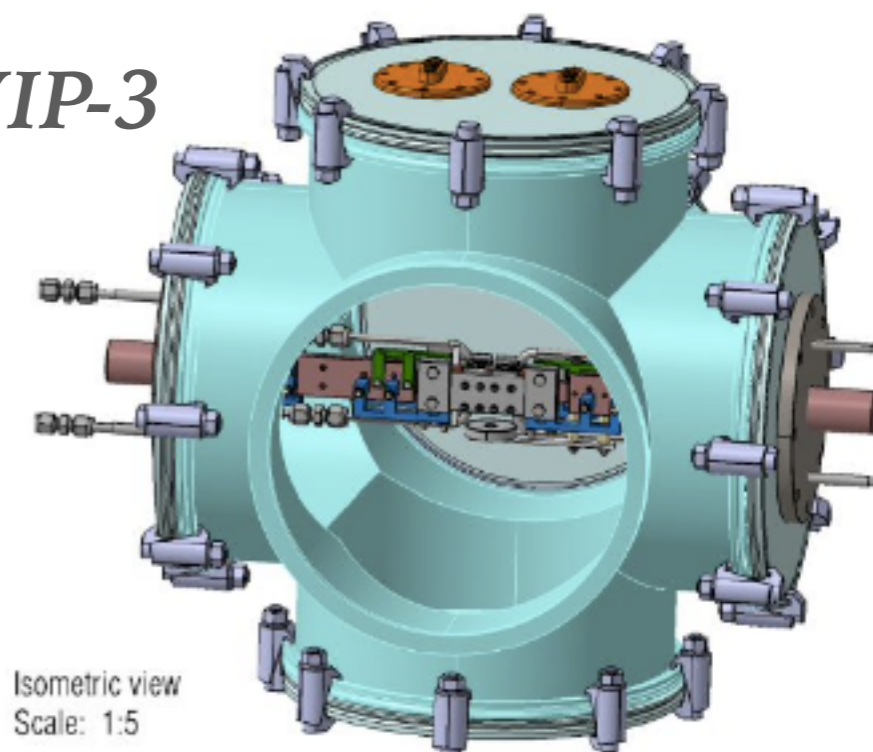

- 2x4 SDDs, 8x8 mm² each, in production with FBK & politecnico di Milano

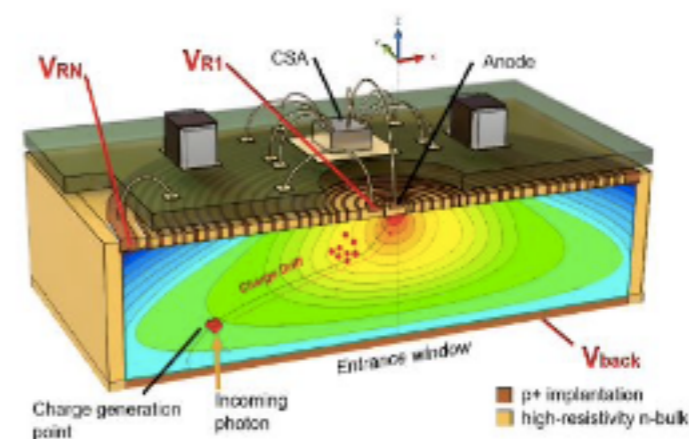

New paradigm for VIP-2

Are Quantum Gravity models experimentally testable?

A. Addazi (Chengdu Univ.) A. Marcianò (Fudan University)

VIP-2 underground experiment as a *Crash-Test* of Non-Commutative Quantum Gravity

Pauli Exclusion Principle (PEP) violations induced from non-commutative space-time can be searched VIP-2 experiment set-up. We show that the limit from VIP-2 experiments on non-commutative space-time scale Λ , related to energy dependent PEP violations, are severe: κ -Poincaré non-commutativity is ruled-out up to the Planck scale. In the next future θ -Poincaré will be probed until the Grand-Unification scale! This highly motivates Pauli Exclusion Principle tests from underground experiments as a test of quantum gravity and space-time microscopic structure.

See also A. Addazi et al., 2018 Chinese Phys. C 42 094001, arXiv:1712.08082 [hep-th]

PEP violation in quantum gravity

Quantum gravity models can embed PEP violating transitions

PEP is a consequence of the spin statistics theorem based on: Lorentz/Poincaré and CPT symmetries; locality; unitarity and causality. Deeply related to the very same nature of space and time



Non-commutativity of space-time is common to several quantum gravity frameworks (e.g. k -Poincaré, θ -Poincaré)



non-commutativity induces a deformation of the Lorentz symmetry and of the locality → naturally encodes the violation of PEP not constrained by MG

PEP violation is suppressed with $\delta^2 (E, \Lambda)$

E is the characteristic transition energy, Λ is the scale of the space-time non-commutativity emergence.

A. P. Balachandran, G. Mangano, A. Pinzul and S. Vaidya, Int. J. Mod. Phys. A 21 (2006) 3111

A.P. Balachandran, T.R. Govindarajan, G. Mangano, A. Pinzul, B.A. Qureshi and S. Vaidya, Phys. Rev. D 75 (2007)

A. Addazi, P. Belli, R. Bernabei and A. Marciano, Chin. Phys. C 42 (2018) no.9

Theoretical prediction *Int.J.Mod.Phys.A* 35 (2020) 32, 2042003

specific calculation of atomic levels transitions probabilities for θ -Poincaré

$$W \simeq W_0 \phi_{PEPV}, \quad \phi_{PEPV} = \delta^2 \simeq \frac{D E_N \Delta E}{2 \Lambda \Lambda} \quad \phi_{PEPV} = \delta^2 \simeq \frac{C \bar{E}_1 \bar{E}_2}{2 \Lambda \Lambda}$$

for non-vanishing (vanishing) electric like components of the $\theta_{\mu\nu}$ tensor.

Connection with quon algebra (in the case of quon fields however the q factor does not show any energy dependence):

$$q(E) = -1 + 2\delta^2(E)$$

An experimental bound on the probability that PEP may be violated in atomic transition processes, straightforwardly translates into a bound on the new physics scale Λ , consistently with the choice of the θ_{0i} components.

Experimental Setup

High purity Ge detector measurement:

- **high purity co-axial p-type germanium detector (HPGe), diameter of 8.0 cm, length of 8.0 cm, surrounded by an inactive layer of lithium-doped germanium of 0.075 mm.**
- **The target material is composed of three cylindrical sections of radio-pure Roman lead, completely surrounding the detector.**

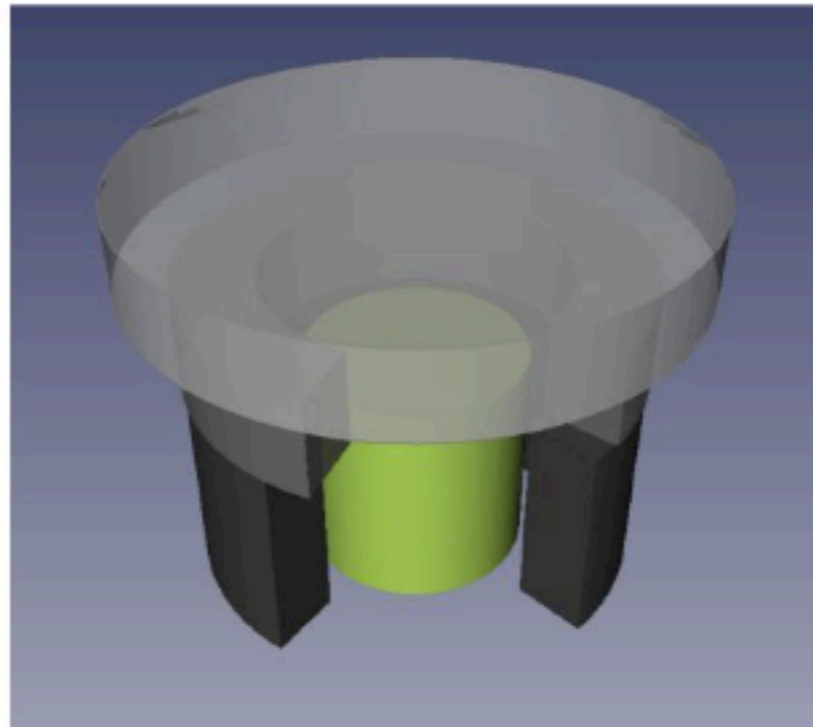

Fig. 1 Schematic representation of the Ge crystal (in green) and the surrounding lead target cylindrical sections (in grey)

Experimental Setup

- **Passive shielding: inner - electrolytic copper, outer - lead**
- **10B-polyethylene plates reduce the neutron flux towards the detector**
- **shield + cryostat enclosed in air tight steel housing flushed with nitrogen to avoid contact with external air (and thus radon).**

K. Piscicchia et al., Eur. Phys. J. C (2020) 80: 508

<https://doi.org/10.1140/epjc/s10052-020-8040-5>

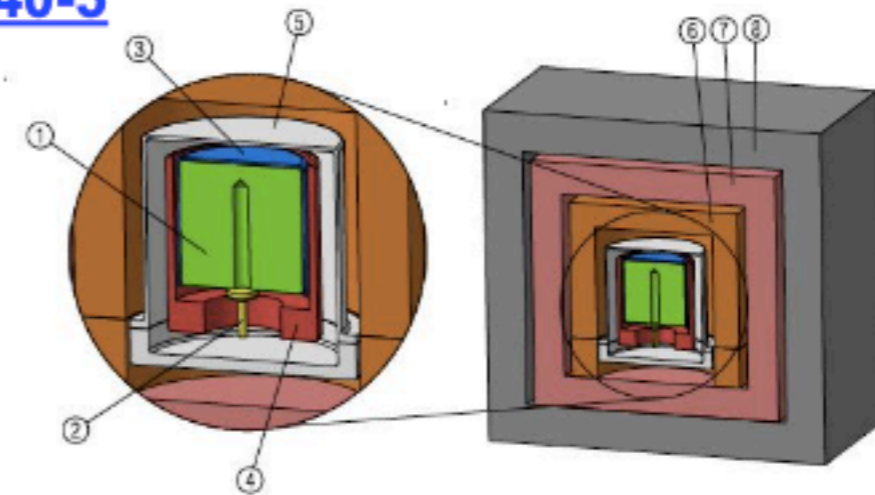
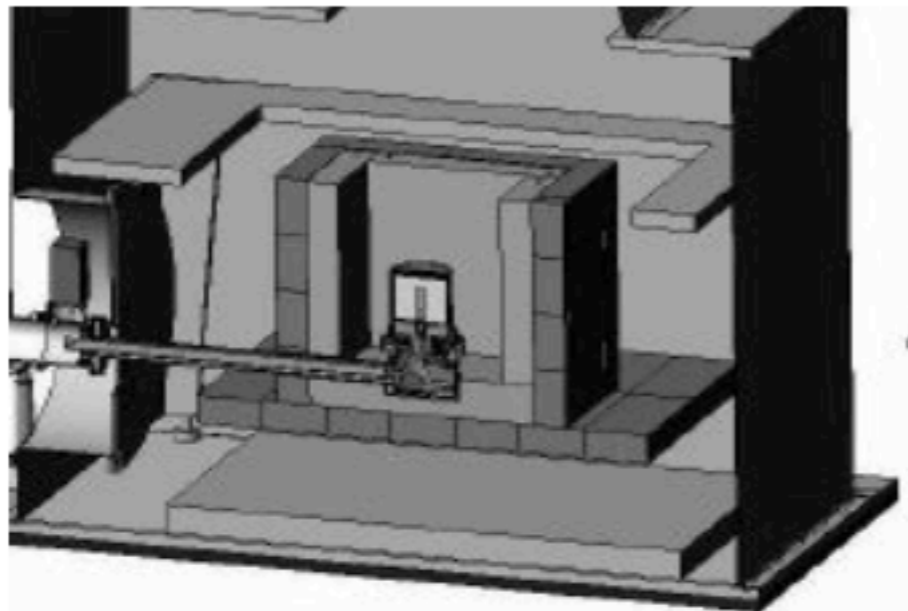
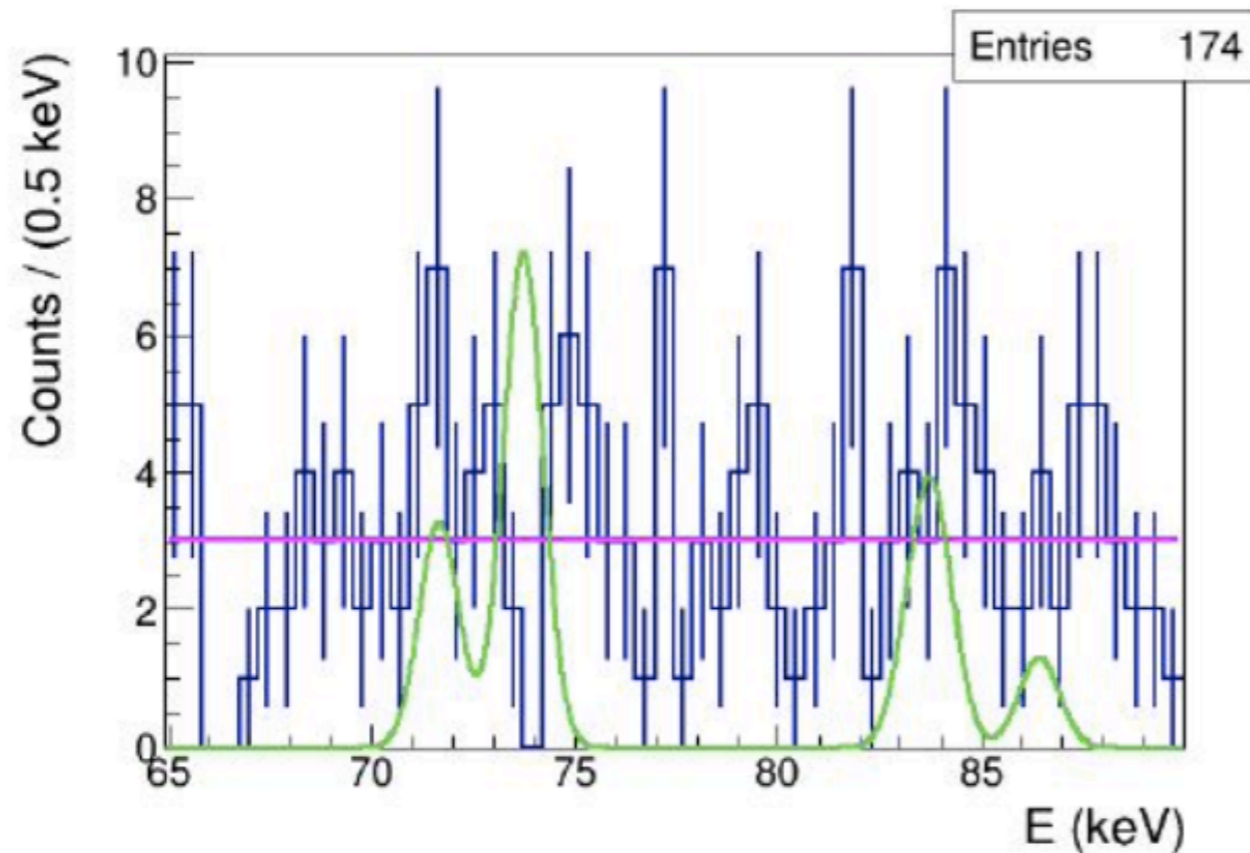

Figure 1: Schematic representation of the experimental setup: 1 - Ge crystal, 2 - Electric contact, 3 - Plastic insulator, 4 - Copper cup, 5 - Copper end-cup, 6 - Copper block and plate, 7 - Inner Copper shield, 8 - Lead shield.

Results



Background

Signal from violating transitions
in Lead

From which an upper limit on the
non-commutativity scale is obtained (90% Probability):

θ_{0i}	\bar{S}	lower limit on Λ (Planck scales)
$\theta_{0i} = 0$	13.2990	$6.9 \cdot 10^{-2}$
$\theta_{0i} \neq 0$	18.1515	$2.6 \cdot 10^2$

accepted PRL: “Strongest atomic physics bounds on Non-Commutative
Quantum Gravity Models”

Conclusions

- *VIP-2 Experiment in data taking: pushing the limit on Pauli exclusion principle violations*
- *BSM scenario motivate precision tests on PEP*
- *VIP-2 set the strongest limit in the MG super selection rule*
- *Publication of full statistics data soon!*
- *Quantum gravity model predict PEP violation in closed systems*
 - *Analyzed with high purity germanium detectors*
 - *Obtained upper limit on non-commutativity scale*

Thank you for your attention!
Questions?

Proof of spin-statistics theorem by Lüders and Zumino

Postulates:

- *The theory is invariant with respect to the proper inhomogeneous Lorentz group (includes translations, does not include reflections)*
- *Two operators of the same field at points separated by a spacelike interval either commute or anticommute (locality – microcausality)*
- *The vacuum is the state of lowest energy*
- *The metric of the Hilbert space is positive definite*
- *The vacuum is not identically annihilated by a field*

From these postulates it follows that (pseudo)scalar fields commute and spinor fields anticommute.

(G. Lüders and B. Zumino, Phys. Rev. 110 (1958) 1450)

Models of Pauli Exclusion Principle (PEP) Violations

Some more PEP Violating models:

Greenberg, O.W. Mohapatra, R.N. Physical Review Letters 1987, 59, 2507
Govorkov, A. Physica A: Statistical Mechanics and its Applications 1994, 203, 655
Rahal, V.; Campa, A. , Physical Review A (1988) 38, 3728

Messiah - Greenberg superselection rule

Superpositions of states with different symmetry are not allowed →
 transition probability between two symmetry states is ZERO

Messiah-Greenberg superselection rule :

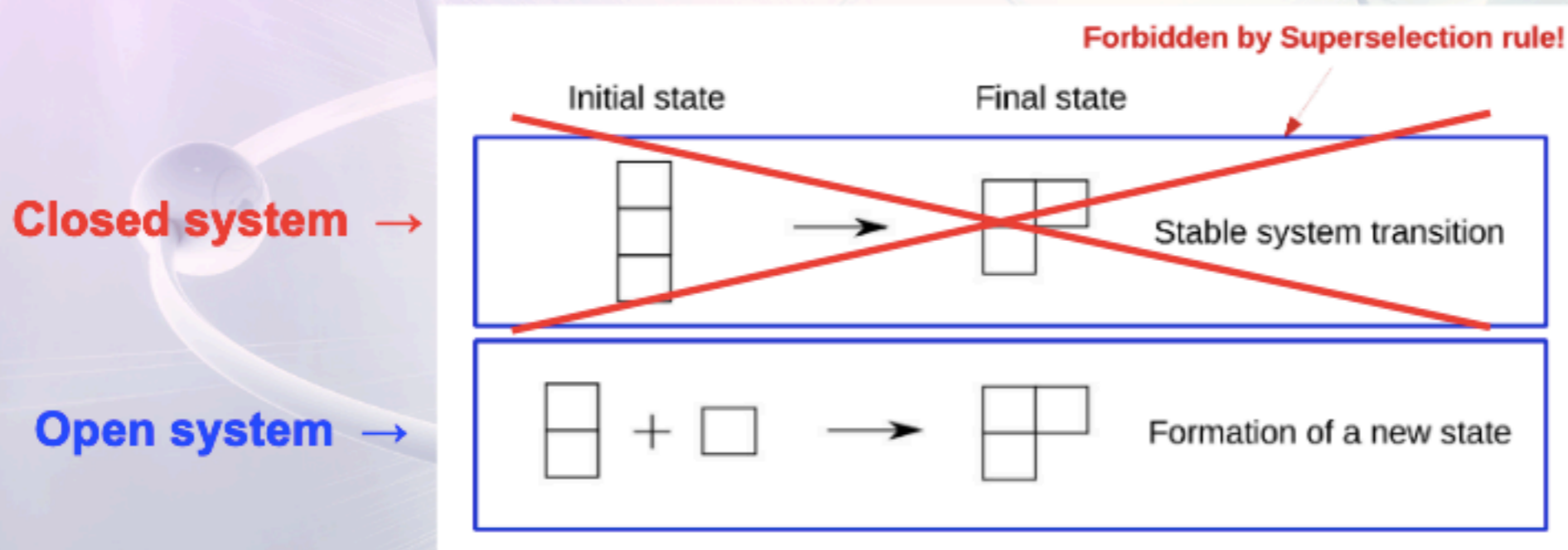

**VIP-open systems sets the best limit on PEP violation
 for an elementary particle
 respecting the M-G superselection rule**

VIP-2 experiment goal

(Upper limit not using Close Encounters (CE) treatment)

As reference for past experiments

Experiment	Target	Upper limit of $\beta^2/2$	reference
Ramberg-Snow	Copper	1.7×10^{-26}	[5]
S.R. Elliott et al.	Lead	1.5×10^{-27}	[14]
VIP(2006)	Copper	4.5×10^{-28}	[12]
VIP(2012)	Copper	4.7×10^{-29}	[13]
VIP2(goal)	Copper	$\times 10^{-31}$	[15]

New paradigm for VIP-2

Quantum gravity models can embed PEP violating transitions!

PEP is a consequence of the spin statistics theorem based on: Lorentz/Poincaré and CPT symmetries; locality; unitarity and causality. Deeply related to the very same nature of space and time



most effective theories of QG foresee the non-commutativity of the space-time quantum operators (e.g. k -Poincaré, θ -Poincaré)



non-commutativity induces a deformation of the Lorentz symmetry and of the locality \rightarrow naturally encodes the violation of PEP

S. Majid, Hopf algebras for physics at the Planck scale, *Class. Quantum Grav.* 5 (1988) 1587.

S. Majid and H. Ruegg, Bicrossproduct structure of Kappa Poincare group and noncommutative geometry, *Phys. Lett. B* 334 (1994) 348, hep-th/9405107.

M. Arzano and A. Marciano, *Phys. Rev. D* 76, 125005 (2007) [arXiv:0707.1329].

G. Amelino-Camelia, G. Gubitosi, A. Marciano, P. Martinetti and F. Mercati, *Phys. Lett. B* 671, 298 (2009) [arXiv:0707.1863].

A. Addazi, A. Marcianò *International Journal of Modern Physics A* Vol. 35, No. 32, 2042003 (2020)



PEP violation is suppressed with $(E/\Lambda)^n$, n depends on the specific model, E is the energy of the PEP violating transition, Λ is the scale of the space-time non-commutativity emergence.