



Accelerator challenges in the Fermilab Neutrino Program

Jeff Eldred

High Brightness 2023 Plenary Session in Geneva Switzerland.

Oct 9th 2023

Acknowledgements

Thank you to Sasha Valishev and Mary Convery for help with slides.

Outline

- Fermilab Accelerator Complex now and in the PIP-II/LBNF era
- Accelerator Complex Evolution (ACE) plan
- Beam to experiments under ACE plan

Recent Performance at Fermilab NuMI Beamline

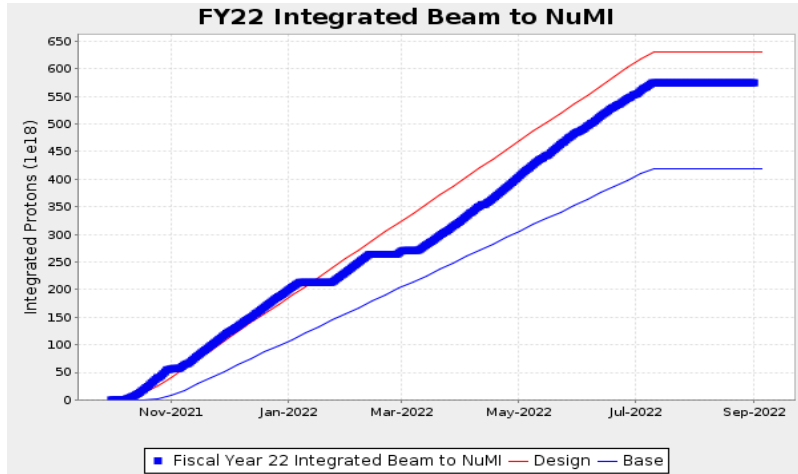

Record beam power of **895 kW!**
Typical operating power **680 kW.**
69% uptime during 9-month run.

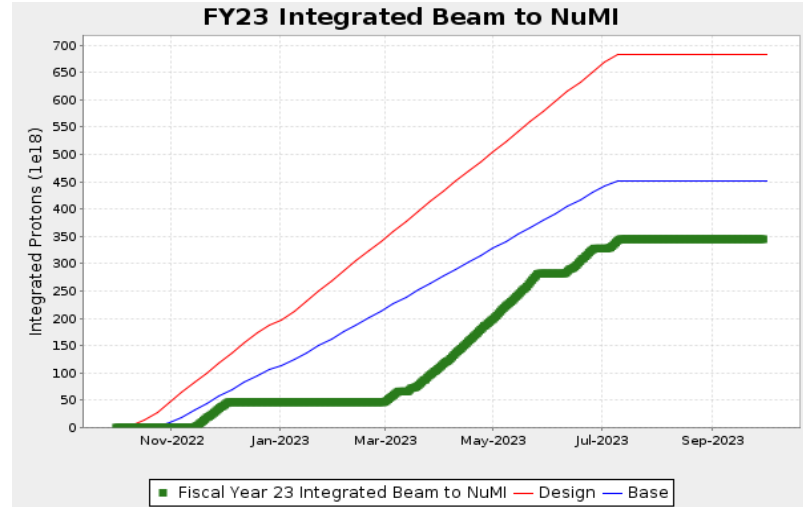

Record beam power of **959 kW!**
Typical operating power **780 kW.**
88-day downtime due to **NuMI horn failure.**

Protons to neutrino program will be maximized by **beam power** and **uptime!**

NuMI Horn/Stripline Failure

(left) Crack in the NuMI Horn stripline above the Horn 2 penetration.

- Believed to be the friction stir welding, not prepped correctly after welding.

(middle, right) Failure in the stripline part of the Horn 2 face, source of failure still being understood.

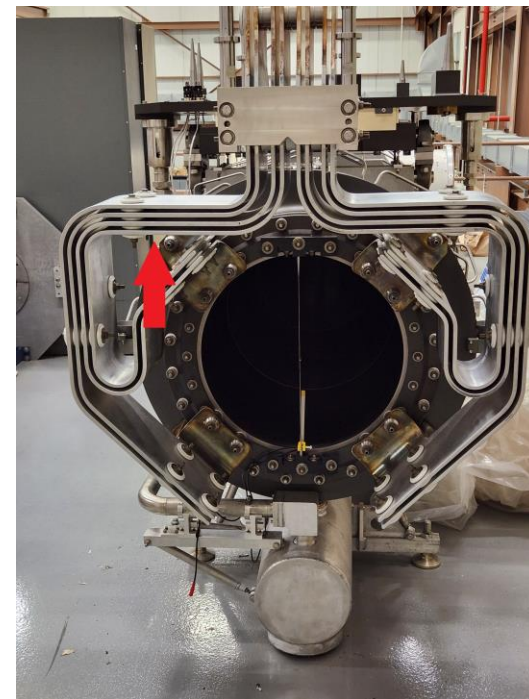

Accelerator Complex

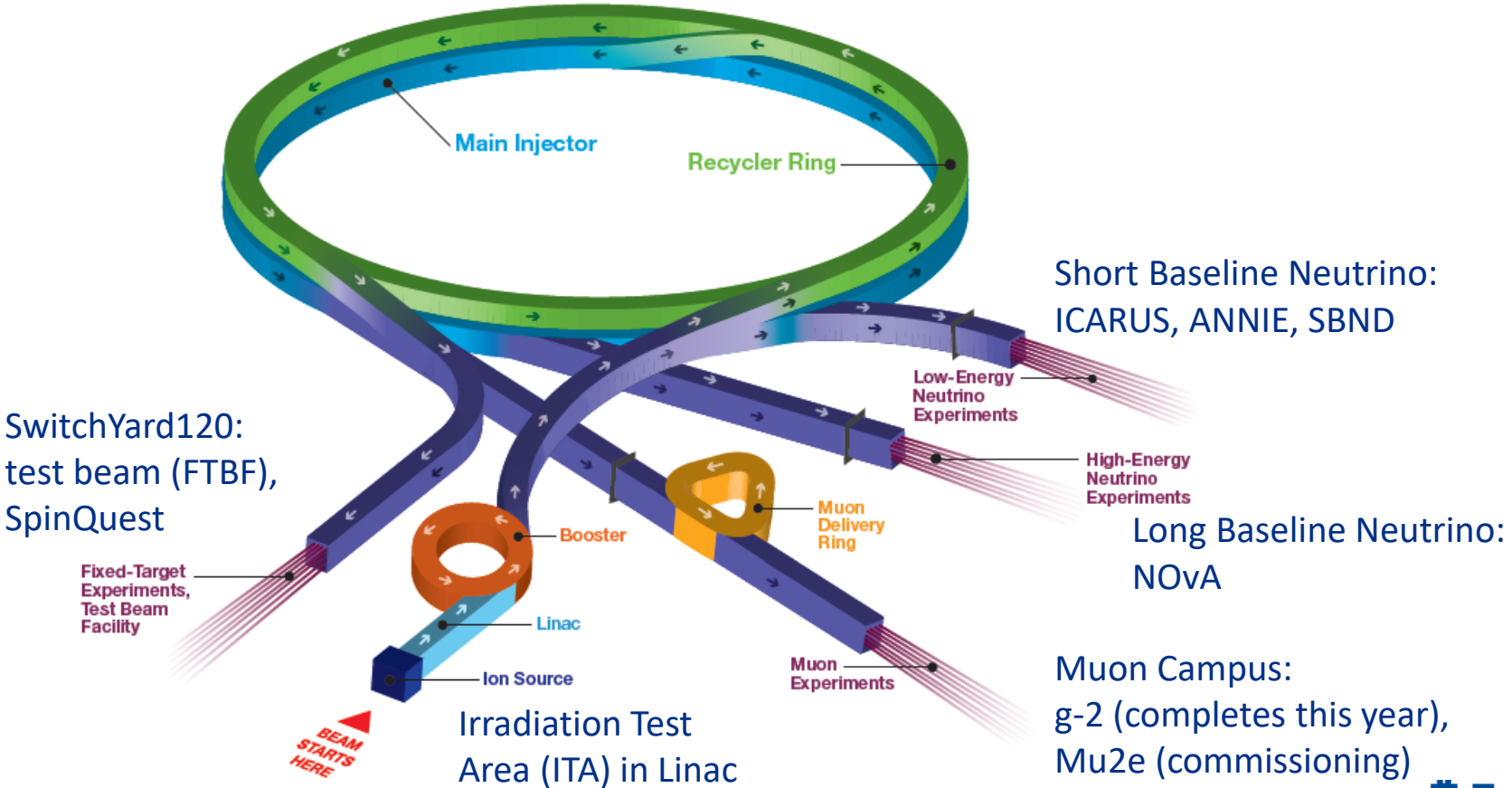

Introduction to Fermilab accelerators

H⁻ linac (1970, 1993, 2012)

- 400 MeV linac ~20mA

Booster synchrotron (1970)

- H⁻ stripping injection (1978)
 - 16 turns to $\sim 4.7 \times 10^{12}$ p per pulse
- Ramp from 0.4 to 8 GeV at 15 Hz

Recycler (1998)

- 3.3 km permanent magnet 8 GeV ring
- Slip-stacking 12 Booster batches, $\sim 56 \times 10^{12}$ p
- Also re-bunches beam for Muon Campus

Main Injector (1998)

- 8 to 120 GeV ramp, cycle time 1.2-1.4 s

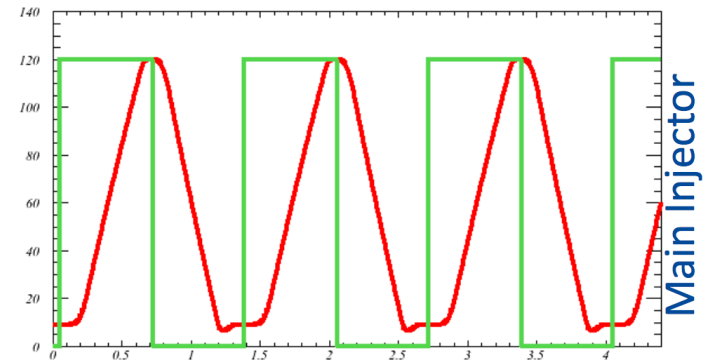
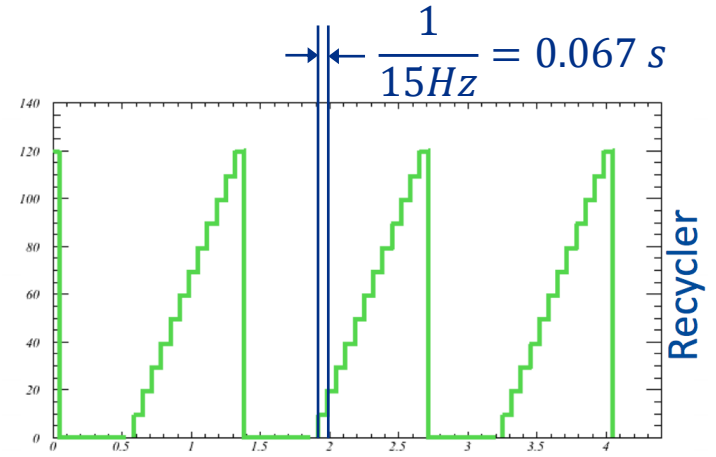

1.33s cycle shown

Accelerator Complex in PIP-II / LBNF era (pre ACE plan)

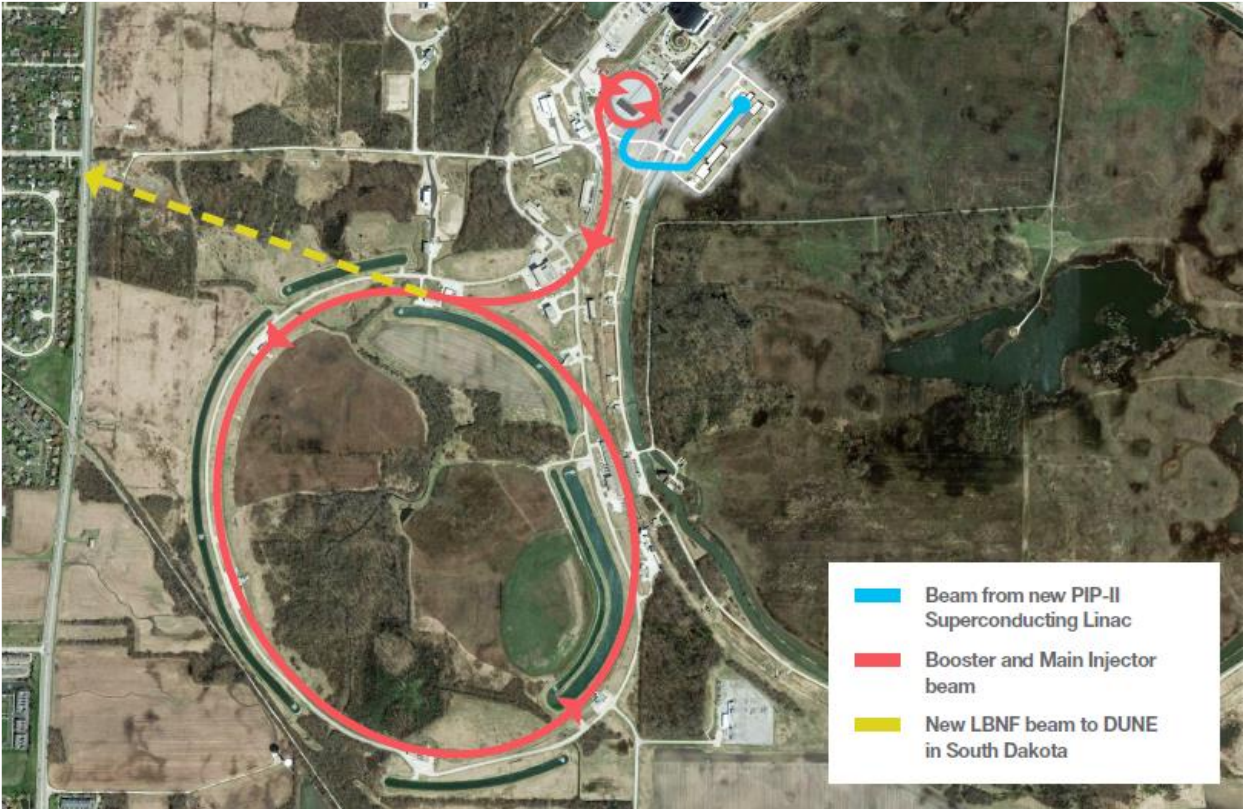

PIP-II Major Milestones

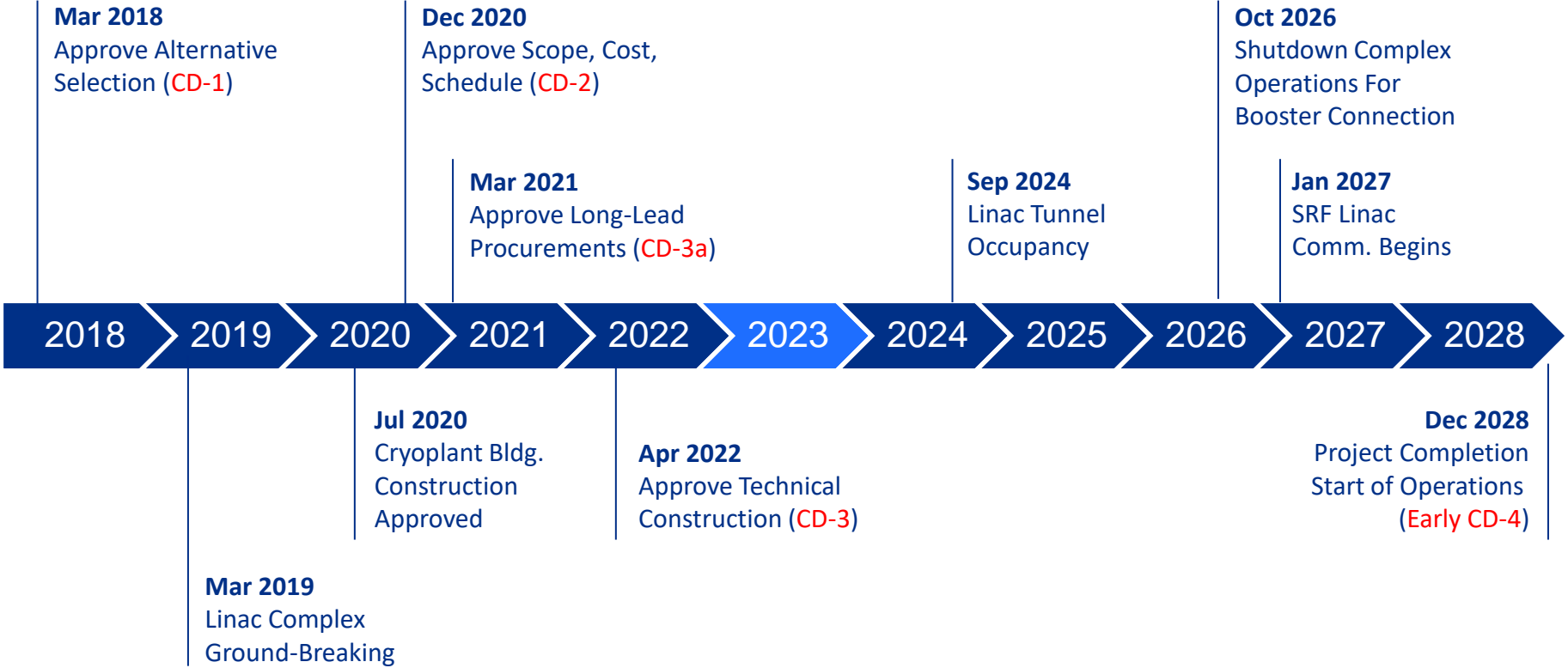

Accelerator Complex in PIP-II / LBNF era (pre ACE plan)

PIP-II Project provides

- New SRF linac for injection into Booster at 800 MeV (present 400 MeV).
- Booster cycle rate upgraded to 20 Hz from 15 Hz.
- Increased proton beam intensity for 1.2 MW beam power from MI.

		PIP-II Booster	
Operation scenario	Nominal	PIP-II	units
MI 120 GeV ramp rate	1.333	1.2	s
Booster intensity	4.5	6.5	10^{12} p
Booster ramp rate	15	20	Hz
Number of Booster batches	12	12	
MI power	0.75	1.2	MW
cycles for 8 GeV	6	12	
Available 8 GeV power	29	83	kW

Accelerator Complex in PIP-II / LBNF era (pre ACE plan)

PIP-II Project provides

- New SRF linac for injection into Booster at 800 MeV (present 400 MeV).
- Booster cycle rate upgraded to 20 Hz from 15 Hz.
- Increased proton beam intensity for 1.2 MW beam power from MI.

		PIP-II Booster	
Operation scenario	Nominal	PIP-II	units
MI 120 GeV ramp rate	1.333	1.2	s
Booster intensity	4.5	6.5	10^{12} p
Booster ramp rate	15	20	Hz
Number of Booster batches	12	12	
MI power	0.75	1.2	MW
cycles for 8 GeV	6	12	
Available 8 GeV power	29	83	kW

Demonstrated

1.133 s

4.7-4.9 e12

0.96 MW

Accelerator Complex in PIP-II / LBNF era (pre ACE plan)

LBNF/DUNE-US Project provides

- New proton beamline for up to **2.4 MW**
- Target systems for **1.2 MW**
- Shielding and absorber for up to **2.4 MW**

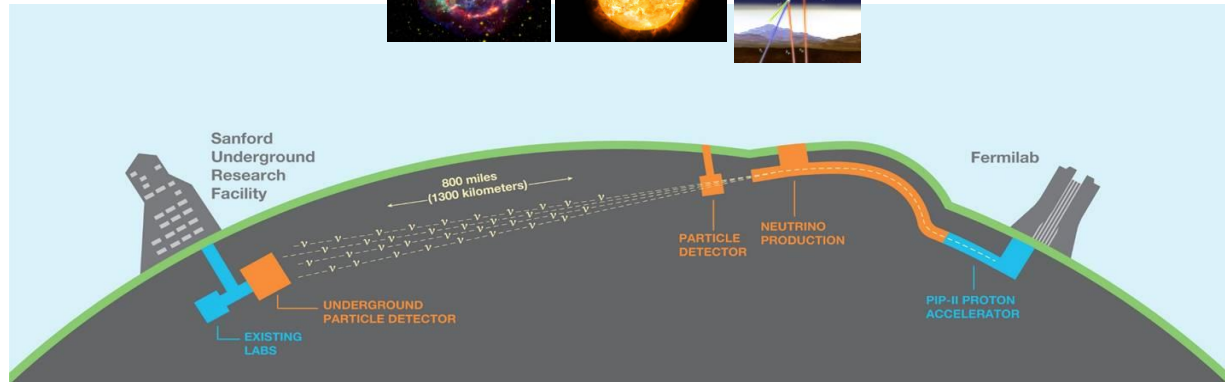
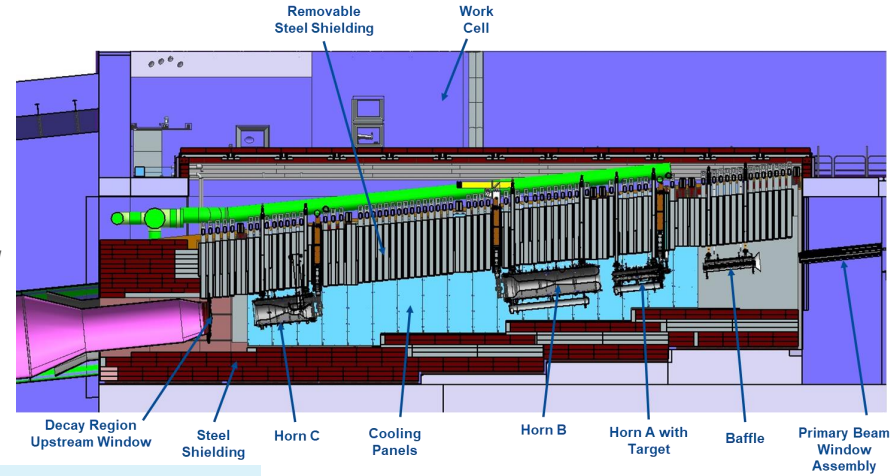

Past & Future Long Baseline Neutrino Program

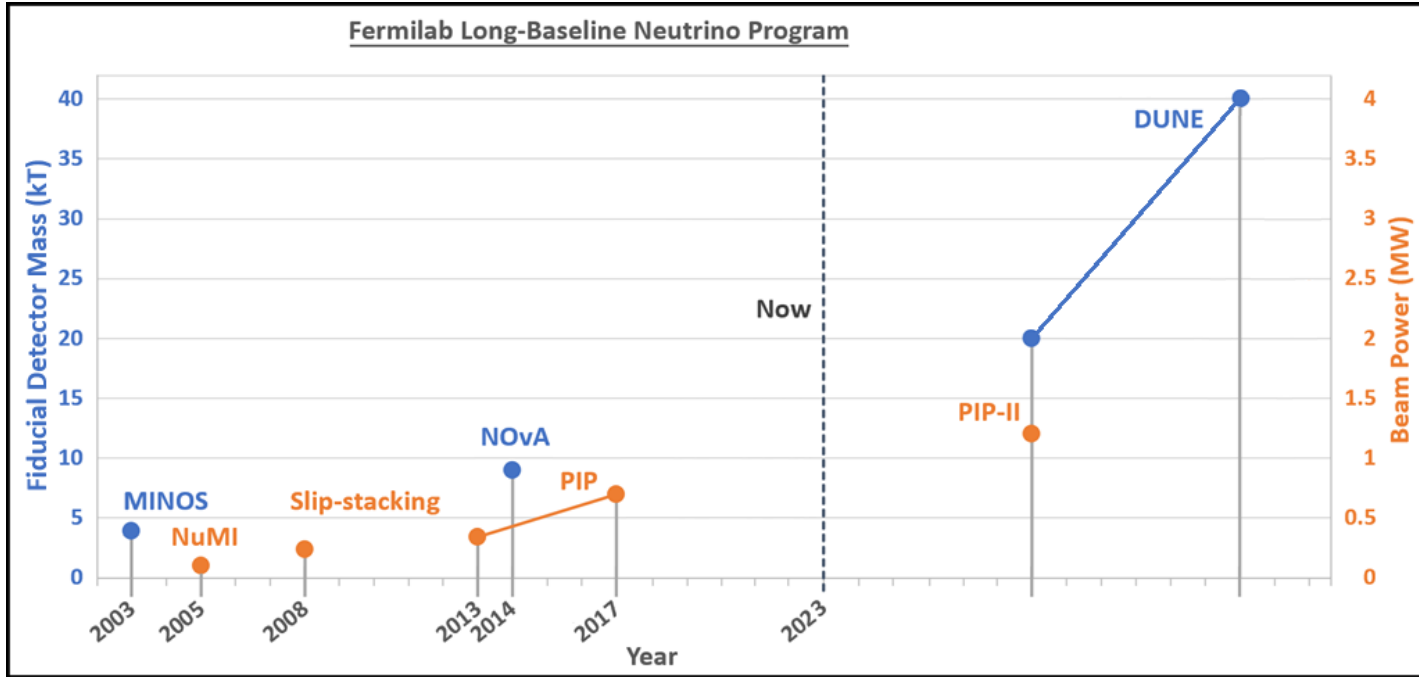

Updated from J. Eldred, JINST 2019

PIP-II upgrade will provide proton power of 1.2 MW (at most 1.35 MW).

Past & Future Long Baseline Neutrino Program (with ACE)

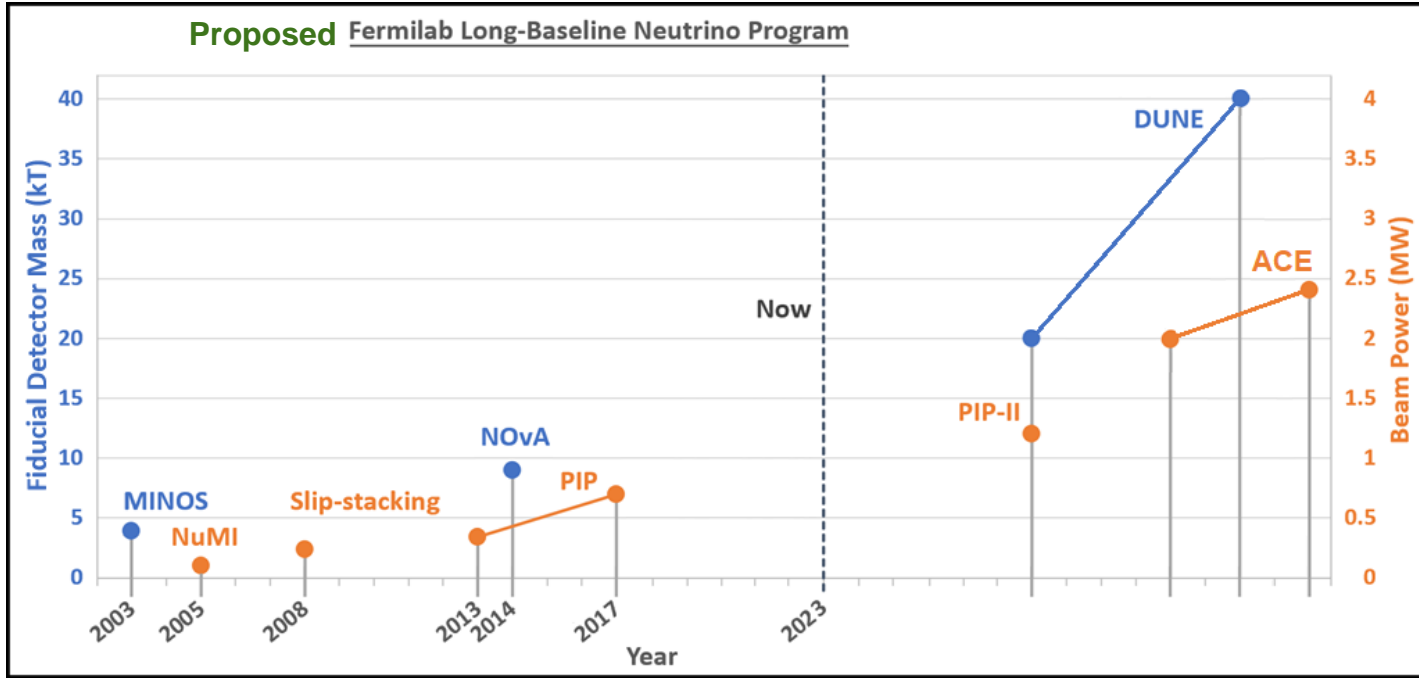

Updated from J. Eldred, JINST 2019

PIP-II upgrade will provide proton power of 1.2 MW (at most 1.35 MW).
ACE upgrade to 2.4 MW will make best use of the 40 kT DUNE detector.

Accelerator Complex Evolution (ACE) plan

Previously referred to as PIP-III

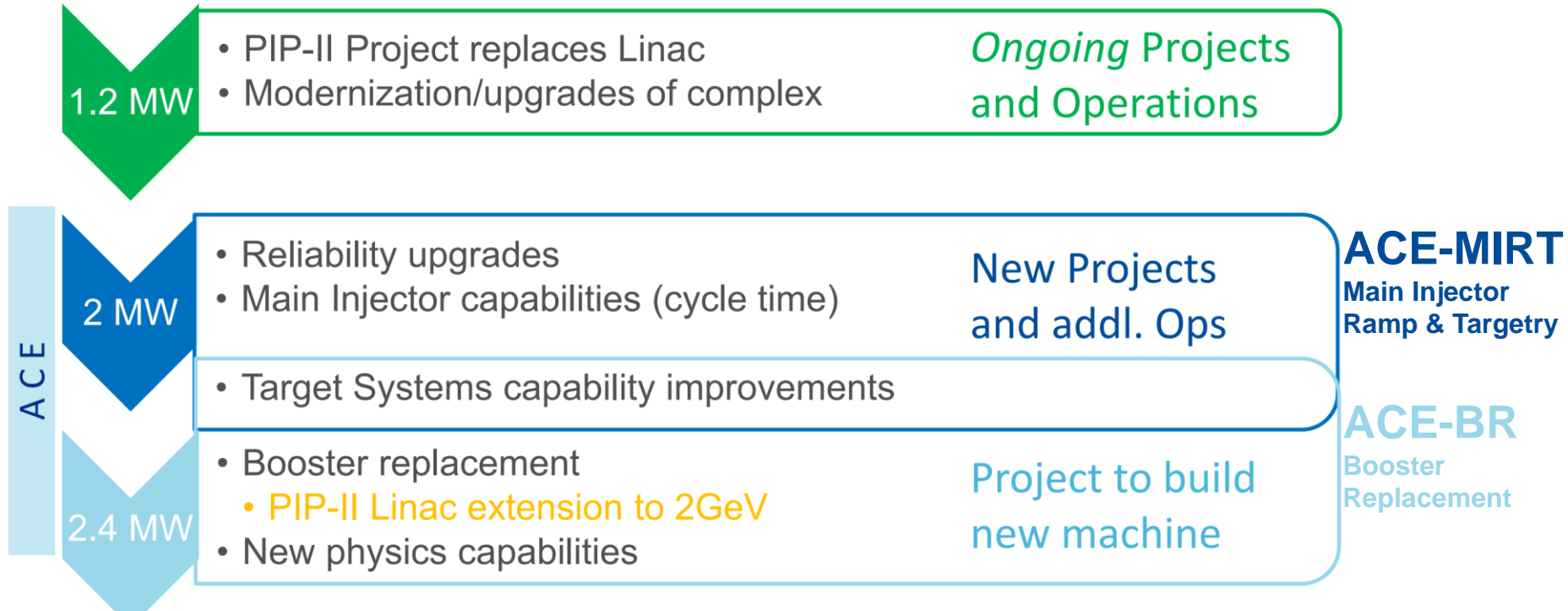

2.4 MW Upgrade with Reliability, Capability, Capacity

ACE MIRT – Main Injector Ramp & Targetry

PIP-II is 1.2 MW for DUNE/LBNF program with 1.2s Main Injector cycle

ACE-MIRT proposed to reduce Main Injector cycle to ~0.65s to increase beam power

Operation scenario	Nominal	PIP-II Booster			units
		PIP-II	A	B	
MI 120 GeV ramp rate	1.333	1.2	0.9	0.7	s
Booster intensity	4.5			6.5	10^{12} p
Booster ramp rate	15			20	Hz
Number of batches	12		12		
MI power	0.75	1.2	1.7	2.14	MW
cycles for 8 GeV	6	12	6	2	
Available 8 GeV power	29	83	56	24	kW

ACE MIRT – Main Injector Ramp & Targetry

Advantages over increasing the per-pulse intensity – reduces likelihood of space charge effects and instabilities, and reduces impact of limited aperture

To shorten the MI cycle from 1.2-1.4s to 0.65s, the ramp needs to be ~twice as fast

Requires more voltage and electrical power

Power supplies, transformers, feeders, service building size, additional tunnel penetrations, additional cooling

RF accelerating system

Replace cavities with newer design (more volts per cavity) or add cavities of current design

Regulation, control & instrumentation

New low-level RF, new power supply regulation/control system

Beam dynamics, losses and shielding

Upgrade MI collimators, upgrade abort line

Improving reliability of the complex

Overall Efficiency

- **Beam Power**, percentage of maximum.
- **Uptime**, percentage of run period.
- **Run Length**, percentage of year.

ACE will

- Replace old infrastructure, design for reliability.
- Procure spares, plan for repairs.
- Improve shutdown work planning.

[ACE-MIRT Workshop last January:](#)

- Controls, personnel, instrumentation, power supplies

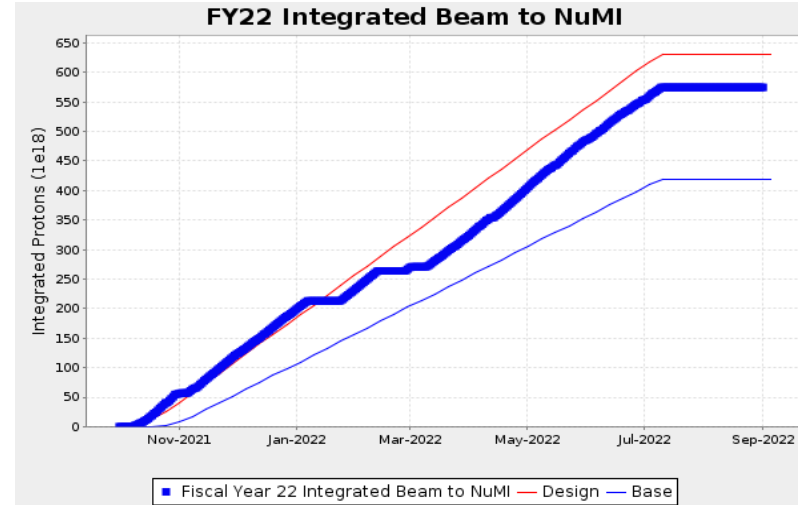

Overall FY22 efficiency 41%,
DUNE/PIP-II goal 57%

DUNE Power and Protons-on-Target (POTs)

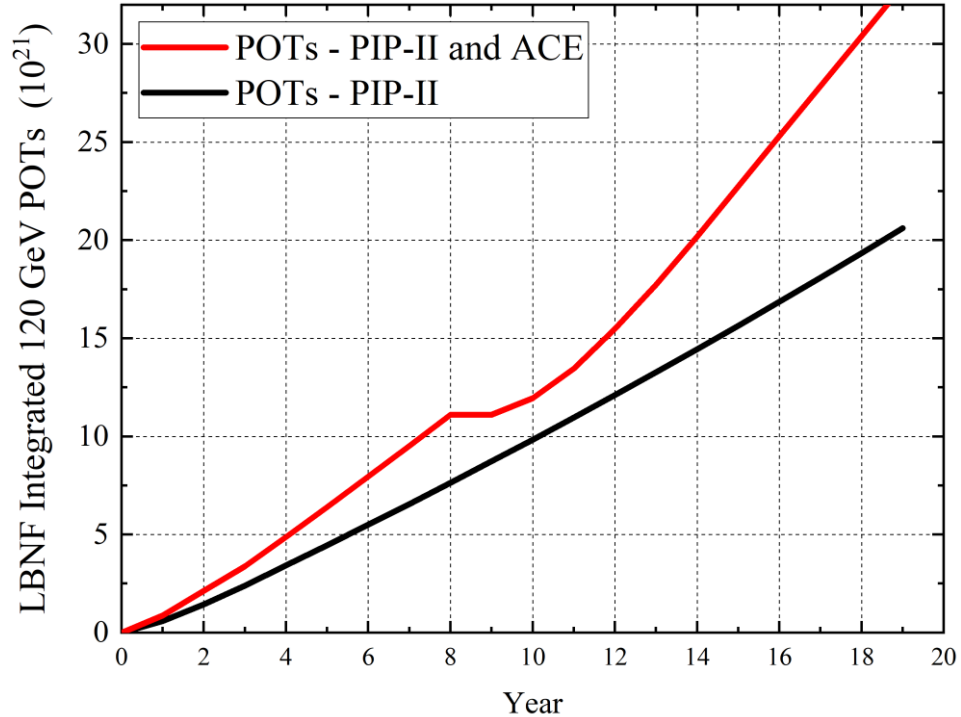
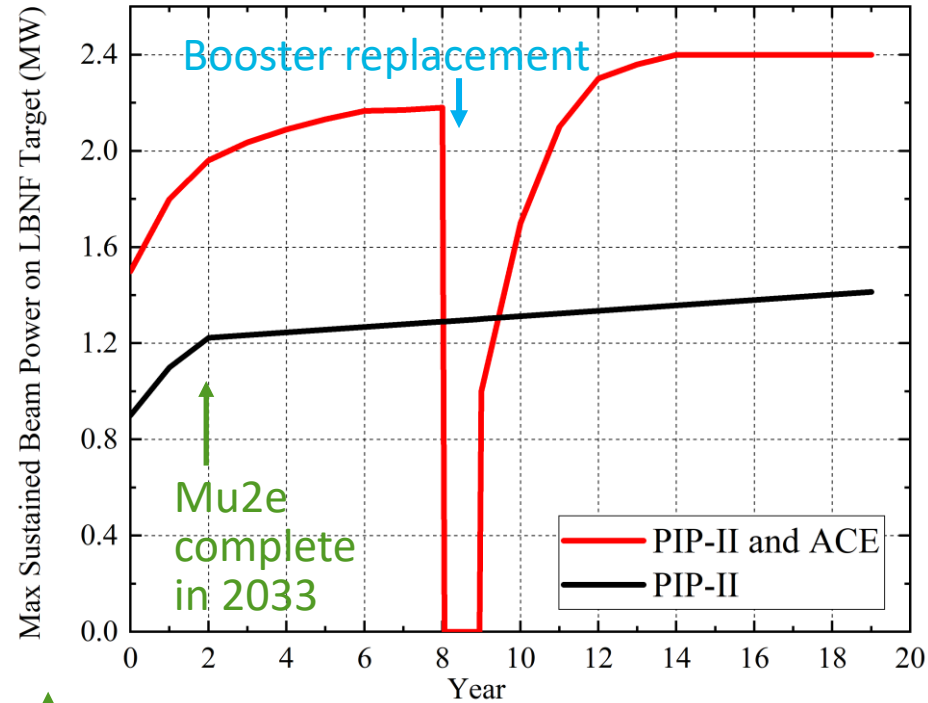

(Mu2e restarts 2029)

LBNF target systems

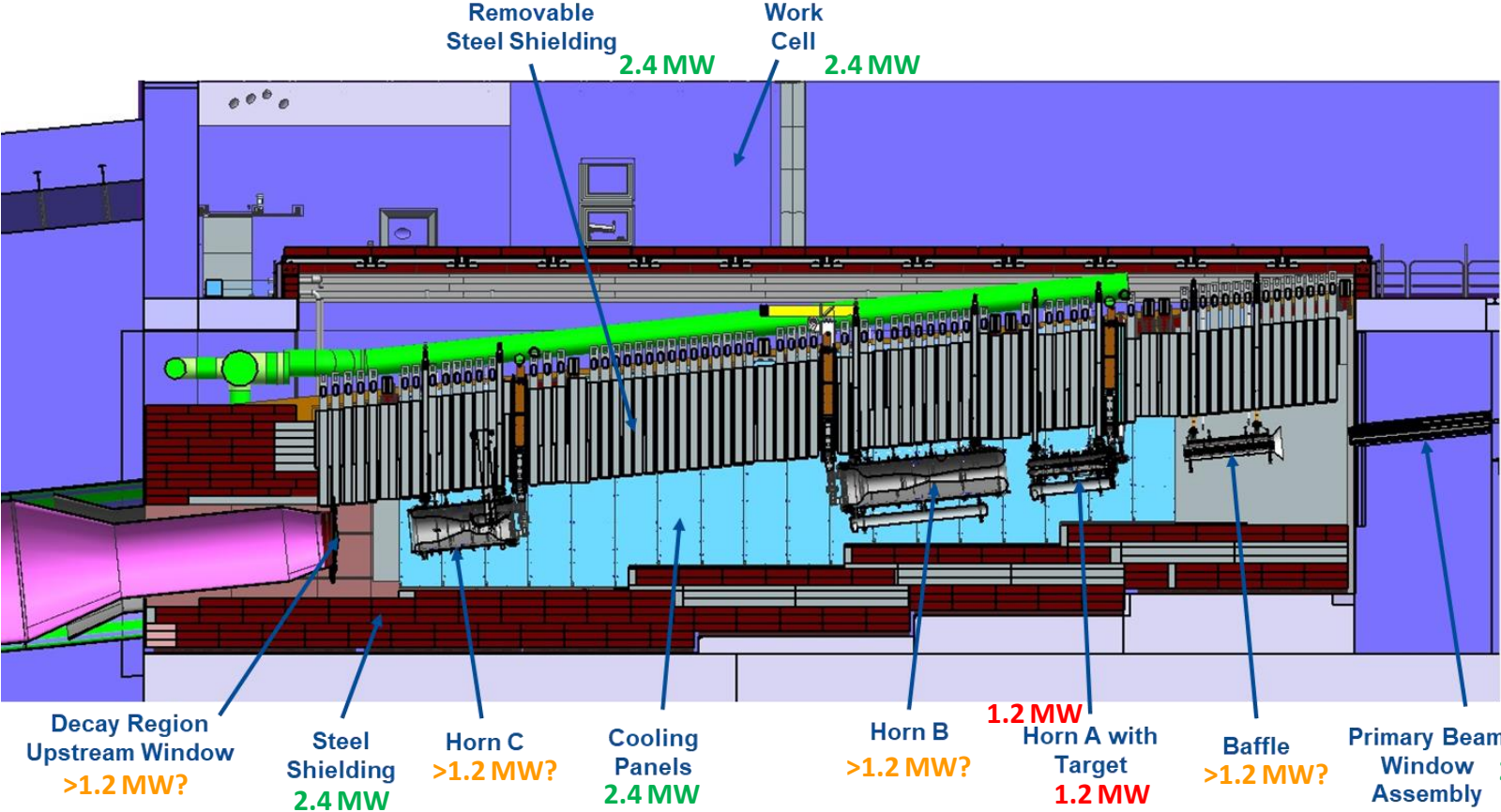

Target development staged approach

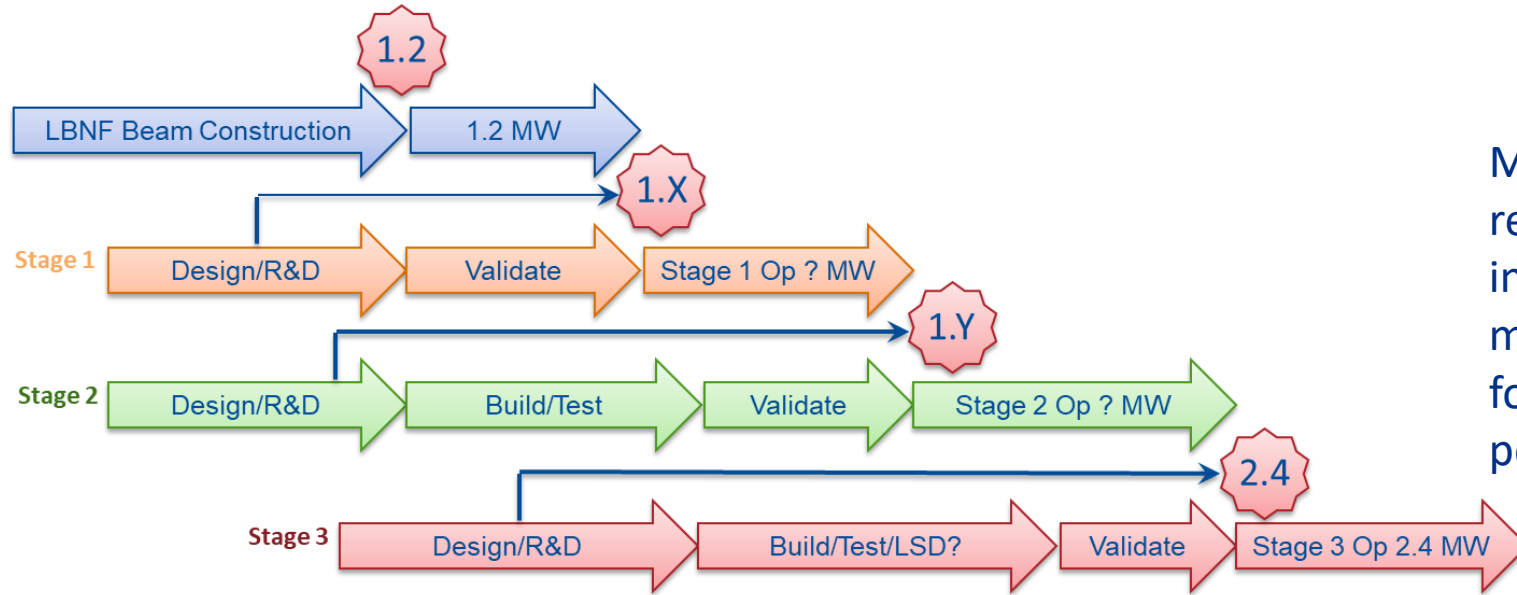

Materials R&D results needed to inform design modifications for higher beam power

- **Stage 1** – Push current designs (1.2 MW) to validated limitations
- **Stage 2** – Design and build 2nd generation components with modifications to existing designs to raise limits while maintaining reasonable useful ν flux/POT
- **Stage 3** – Design and build fully optimized next generation systems to take full advantage of maximum POT from accelerator complex (may not be needed)

Target materials R&D on critical path to 2+ MW target

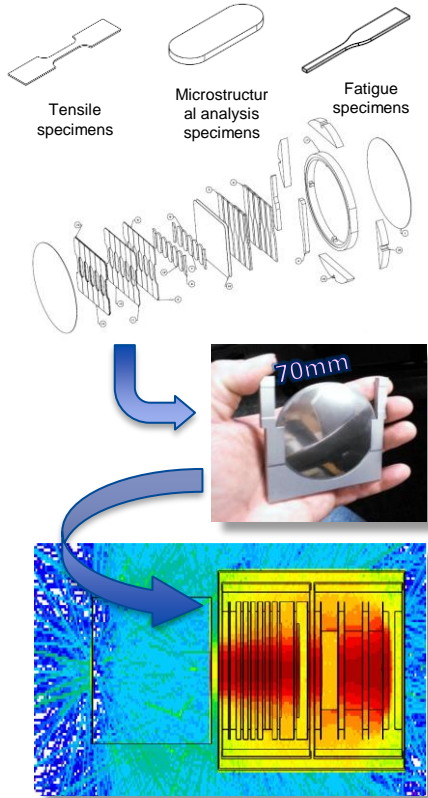

1. Identify candidate materials
2. High-energy proton irradiation of material specimens to reach expected radiation damage
3. Pulsed-beam experiments of irradiated specimens to duplicate loading conditions of beam interactions
4. Non-beam PIE (Post-Irradiation Examination) of specimens
 - Material properties
 - Microscopic structural changes
 - High-cycle fatigue testing

Five-year cycle needs to start ASAP

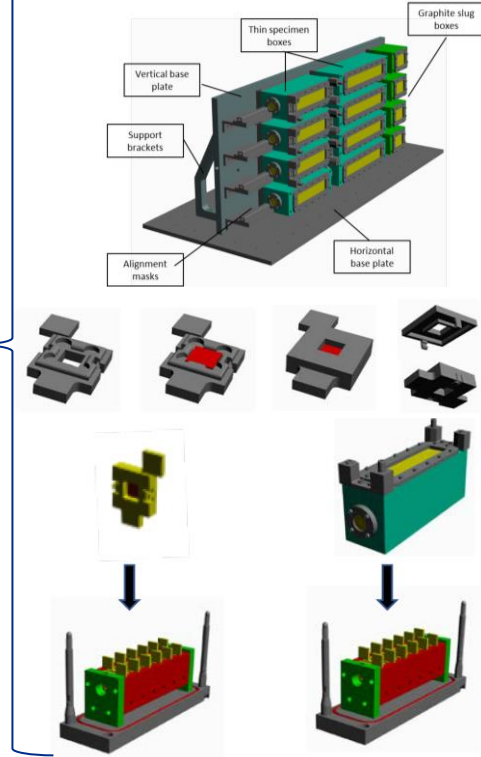

Horns for 2.4 MW performance

- Horn A requires reanalysis and likely redesign
 - 1.2 MW analysis indicates 2.7 safety factor on fatigue endurance limit
 - Likely redesign to:
 - Avoid beam heating in critical locations
 - Strengthen structure in critical locations
- Horns B&C see less beam heating
 - Safety factor: 7.3 for 1.2 MW operation
 - Require reanalysis, but less likely redesign

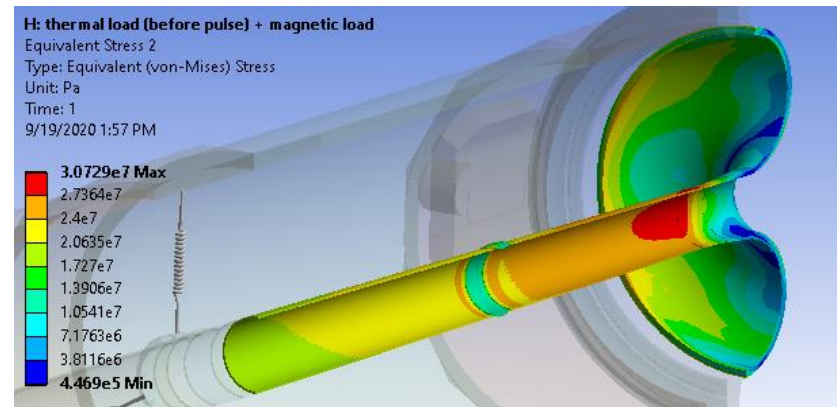
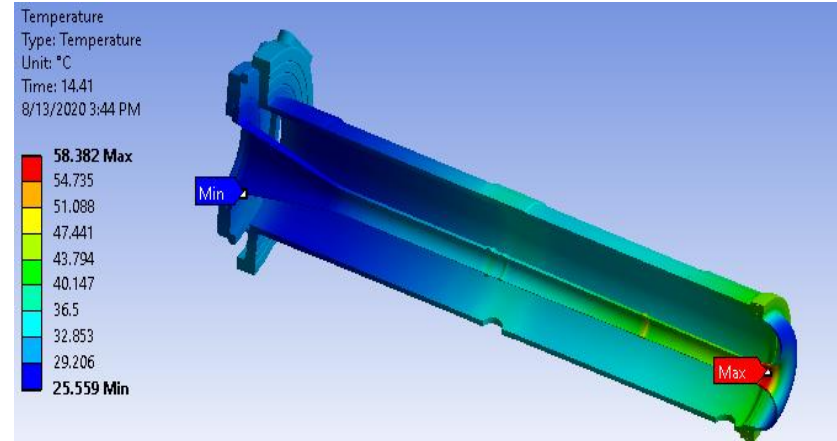

LBNF beamline

Larger power supplies to ramp twice as fast, may need more building space

Kicker power supply modifications to charge up faster

Cooling water: additional pumps to remove and exhaust additional heat

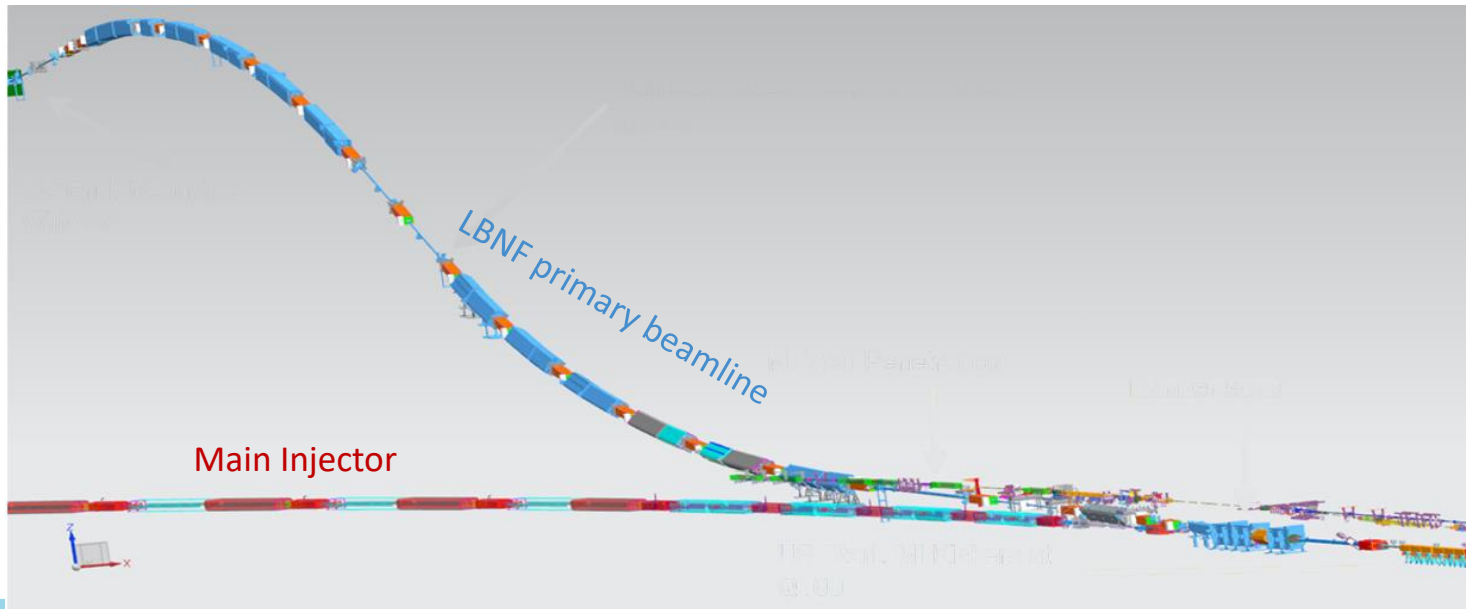

Impact of ACE-MIRT shortened cycle on other experiments

- In a nominal 1.2s cycle at 20Hz
 - 12 Booster batches slip-stacked together in the Recycler, accelerated to 120 GeV in the MI, extracted to LBNF (~0.65s in Recycler)
 - 2 Booster batches for Mu2e rebunched in the Recycler and extracted to the Delivery Ring one bunch at a time, as the bunch is resonantly extracted from the Delivery Ring in a 0.43ms slow spill to Mu2e (~0.55s in Recycler)
 - 10 Booster batches available to other experiments while Mu2e beam is in the Recycler
- In a 0.65s cycle (pre Booster Replacement)
 - Recycler not available for Mu2e (finish Mu2e before reduce cycle time)
 - 1 Booster batch available to other experiments

Accelerator Complex Evolution (ACE) plan

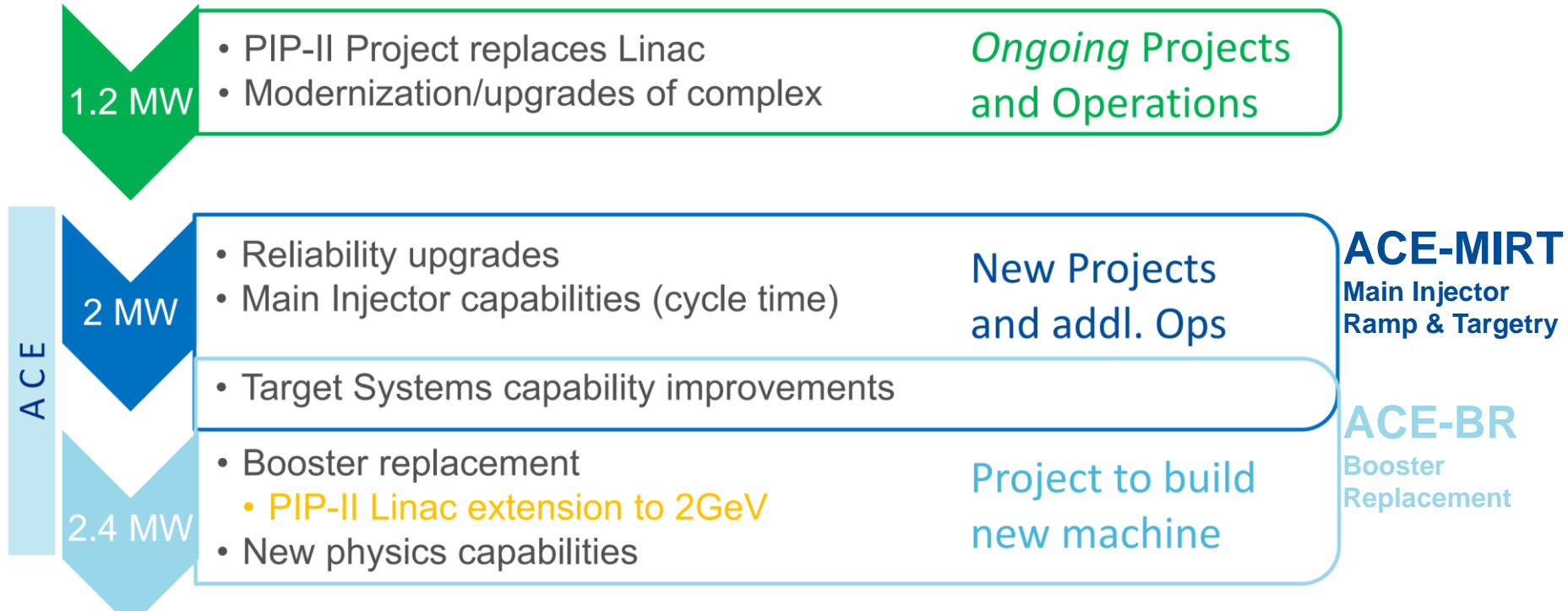

2.4 MW Upgrade with Reliability, Capability, Capacity

DUNE Power and Protons-on-Target (POTs)

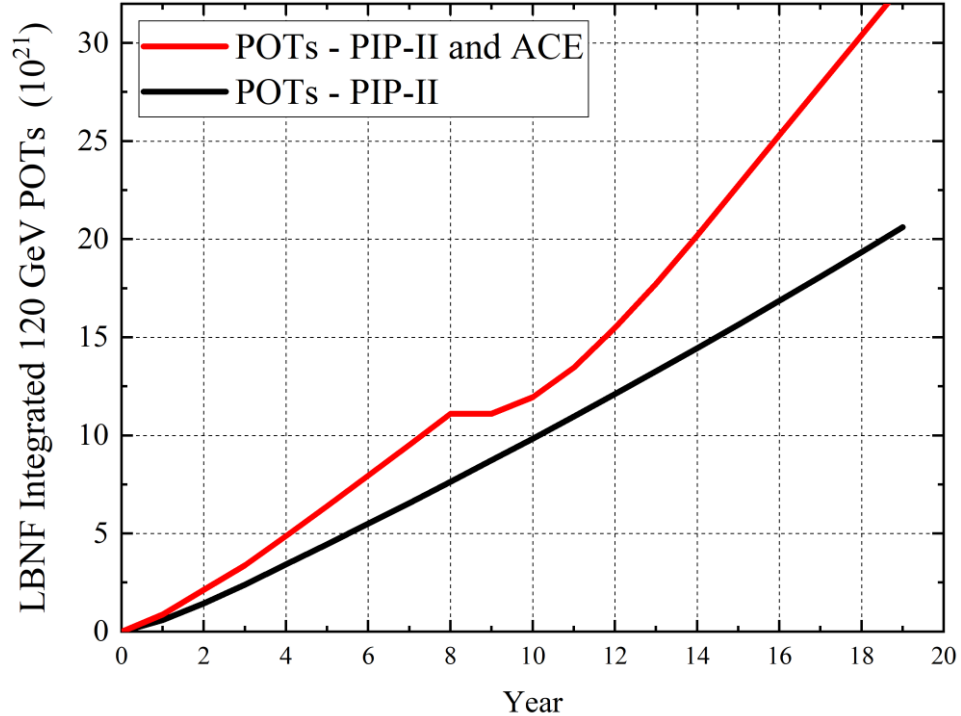
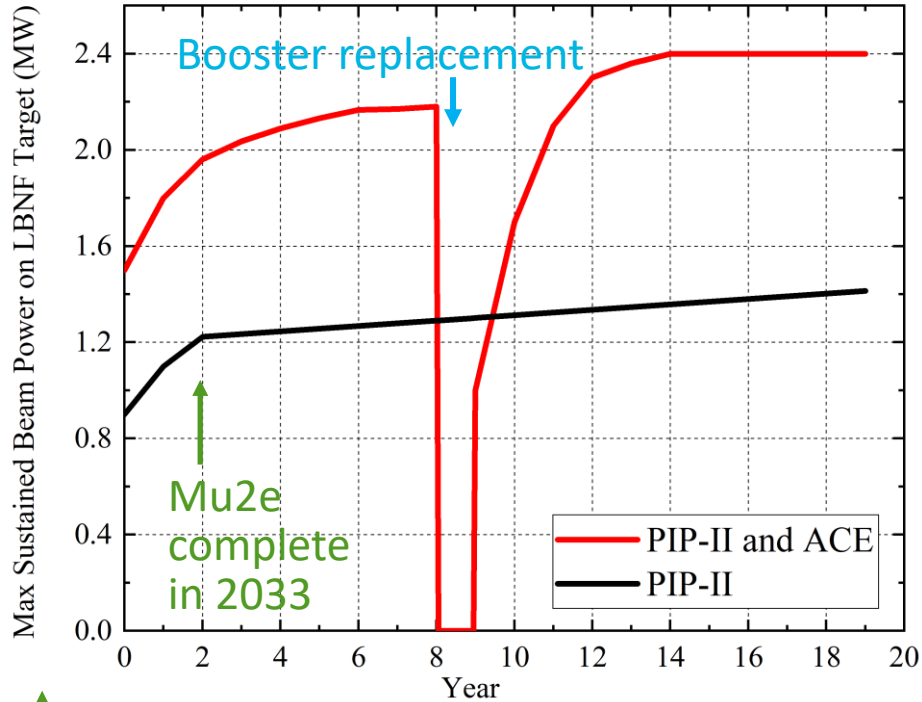

(Mu2e restarts 2029)

ACE BR – Booster Replacement

The Fermilab Booster will be over 60 years old.

- Booster intensity limited by the injection region and transition-crossing.

ACE BR is a new accelerator that will be greater reliability and intensity.

- Either a 2-GeV Linac + a 2-8 Rapid-Cycling Synchtron (RCS)
- Or an 8-GeV SRF Linac + an 8-GeV Accumulator Ring (AR)

ACE-BR will provide 2.4 MW to LBNF.

Potential new science beamlines ('spigots'):

- 2 GeV Continuous Wave (CW)
- 2 GeV Pulsed Beam (~ 1MW)
- 8 GeV Pulsed (~ 1MW)

Platform for collider R&D; upgradeable to front-end for future Muon Collider.

[Recent ACE-BR Science Workshop in June 2023.](#)

Example Booster replacement options and possible add-ons

2GeV Linac + 2-8GeV RCS

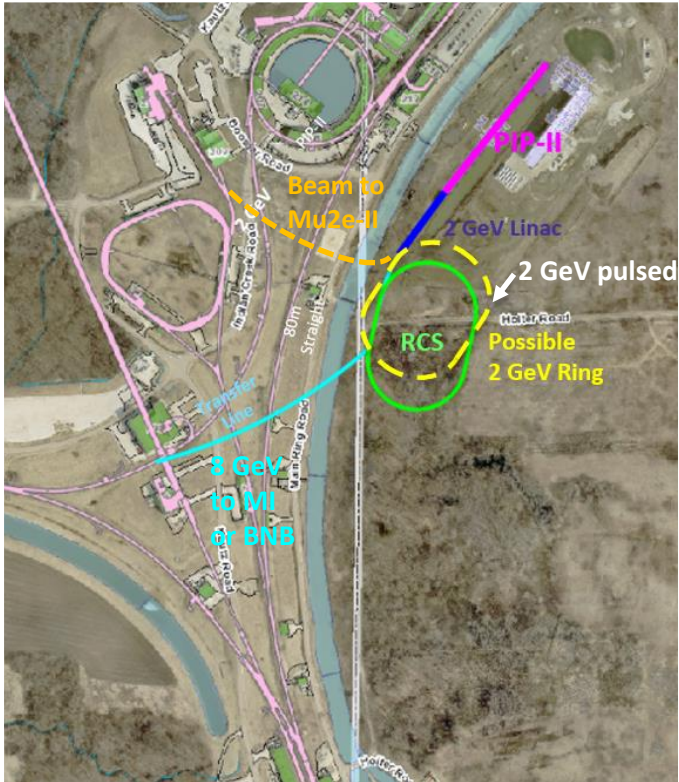

or

8GeV Linac + 8GeV AR

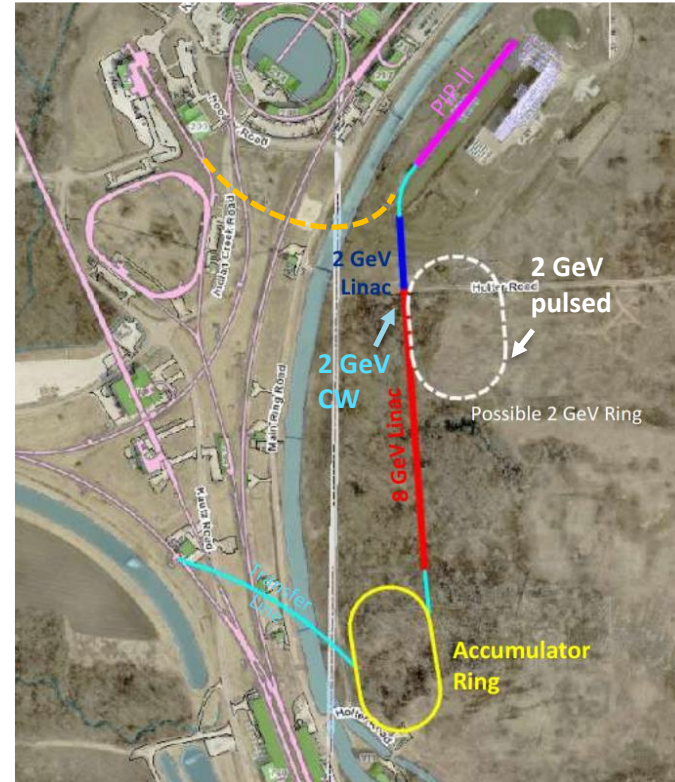

Booster replacement options

- Extend SRF Linac to higher energy or construct new Rapid-Cycling Synchrotron
- Looked at 3 representative options of each type
- All six configurations require an extension of the SRF Linac to 2 GeV
 - The RCS option will benefit from the reduced space charge at the increased energy
 - The high-energy linac option will need the beam with an approximate energy of 2 GeV to take advantage of higher frequency, $\beta = 1$, high-gradient cavities that can be grouped and fed from a single, high-power klystron.
- Parameters can be re-optimized based on future experimental program.

Rapid-Cycling Synchrotron (RCS)

v1: 10 Hz: Metallic vacuum chamber

v2: 20 Hz: Ceramic vacuum chamber, larger aperture magnets, accumulator ring

v3: 20 Hz: (C1b) with high-current linac, no accumulator ring

SRF Linac and Accumulator Ring

v1: Basic: small increase in PIP-II current, using demonstrated XFEL RF

v2: High current (5mA) and some RF R&D

v3: High current and significant RF R&D

Challenges and R&D Topics

H⁻ Foil Injection (RCS, Linac)

- Foil overheating, particles scattering off foil, unstripped H⁻, overall chicane length.
- Greatest challenge for RCS and Linac scenarios (although not for PIP-II Booster).
- Laser H⁻ stripping injection could be the way forward.

SRF Technology (Linac)

- Improve accelerating gradient and Q-factors.
- Develop XFEL-style klystrons with 3ms long pulses.

Metallized Ceramic Beampipe (RCS)

- Can metallized ceramic beampipe (like at J-PARC, ISIS) be deployed with a smaller aperture, reduced impedance, and greater replaceability?

Space-Charge (RCS)

- Bunch-lengthening RF and injection painting, but also electron-lenses?

Summary

- The ACE plan includes the following key components
 1. Upgrades to Main Injector accelerator systems and infrastructure to enable beam power above 1.2MW through faster cycle time and efficient operations of the complex with the aim of achieving DUNE goals as fast as possible, upgrades between 2024 and 2032
 2. Accelerated profile of high-power target system R&D to enable above 1.2MW operations in DUNE Phase I
 3. Establishment of a Project for Booster Replacement with superior capacity, capability, and reliability to be tied to the accelerator complex at a time determined by the DUNE physics
- Neutrino beam challenges and R&D areas
 - **Near-term:** high-power targetry, reliability, controls, ML.
 - **Next-gen:** H- injection, SRF gradients, machine impedance, space-charge.

Backup Slides (ACE-Era Experimental Program)

Impact of shortened cycle on other experiments

PIP-II Era MI Cycle:

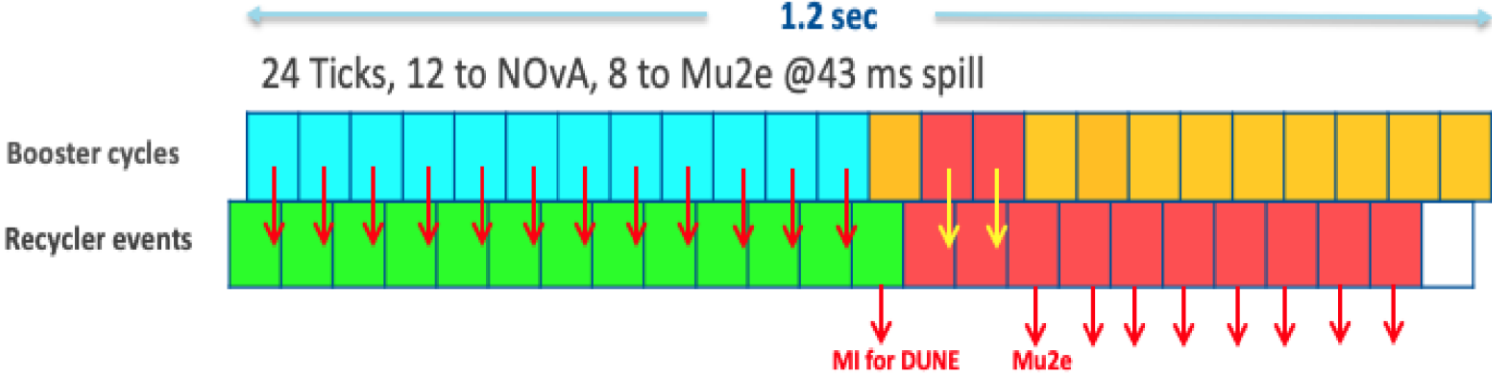

ACE-MIRT MI Cycle:

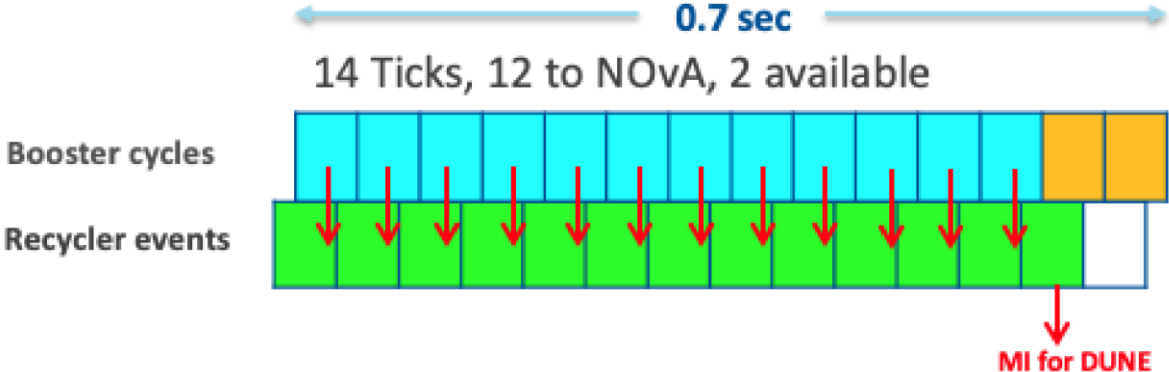

Options for beam sharing for DUNE / Mu2e

1. Limit beam power to DUNE (1.2s cycle) until Mu2e complete (2033)
 - Mu2e beam request is 3.6×10^{20} POT physics data, total 4.7×10^{20} including calibration
 - May be consistent with LBNF/DUNE commissioning, high-power target/horn development
2. Run shorter cycle time with shortened spill durations to Mu2e
 - Has some effect on Mu2e physics, working with experiment to quantify
3. Run shorter cycle time with fewer spills to Mu2e
 - Extends duration needed to obtain requested Mu2e dataset
 - DUNE larger initial dataset but no overall gain
 - Less efficient use of Recycler

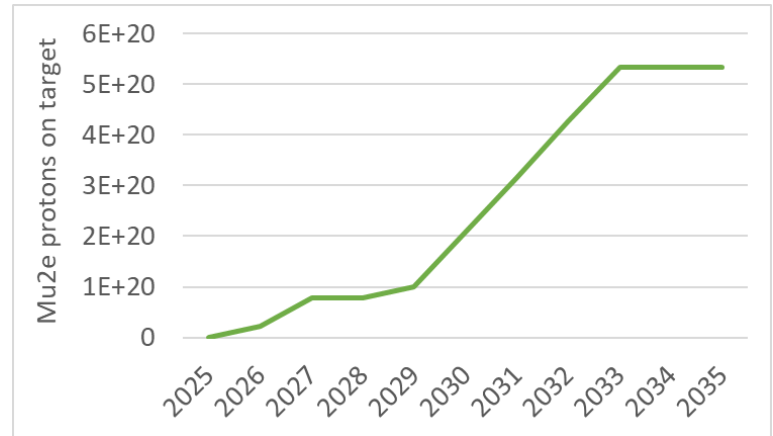

Fermilab is committed to delivering Mu2e

Linac Beams with ACE-BR

Linac Beam at	0.0-0.8 GeV	0.8-2 GeV	2-8 GeV
PIP-II	2mA, CW	-	-
ACE RCS v1	2mA, CW	2mA, CW	-
ACE RCS v2	2mA, CW	2mA, CW	-
ACE RCS v3	5mA, 2ms, 20Hz	5mA, 2ms, 20Hz	-
ACE Linac v1	2.7mA, CW	2.7mA, 2ms, 20Hz	2.7, 1.5ms, 10Hz
ACE Linac v2	5mA, 2ms, 20Hz	5mA, 2ms, 20Hz	5mA, 2ms, 10Hz
ACE Linac v3	5mA, 2ms, 20Hz	5mA, 2ms, 20Hz	5mA, 2ms, 20Hz

RCS v1, RCS v2 extend CW linac out to 2 GeV

RCS v3, Linac v2, Linac v3 may lose CW capability for enhanced pulsed linac.

Linac v1 upgrades CW linac at 0.8 GeV, pulsed thereafter.

Pulsed Beam Power Available with ACE-BR

Pulsed Power at	0.8-2.0 GeV*	8 GeV
PIP-II	up to 2000 kW	80 kW
ACE RCS v1	up to 4000 kW	160 kW
ACE RCS v2	up to 2000 kW	720 kW
ACE RCS v3	400 kW	720 kW
ACE Linac v1	up to 2000 kW	160 kW
ACE Linac v2	400 kW	570 kW
ACE Linac v3	400 kW	1200 kW

0.8-2.0 GeV Power*: Pulsed power only if there is an accumulator ring, and only up to the capabilities of the accumulator ring.

8 GeV Power: What is available after serving DUNE/LBNF program.
ACE-BR has a major impact on the 8-GeV power!

Muon Collider

Synergies with ACE program			
ACE	Target	SRF	Proton Driver
Main injector upgrade	YES		
Booster replacement	YES	YES	YES

Fermilab ACE program offers several synergies with Muon Collider R&D.

The ACE Booster Replacement plan could provide a path to a Muon Collider front-end.

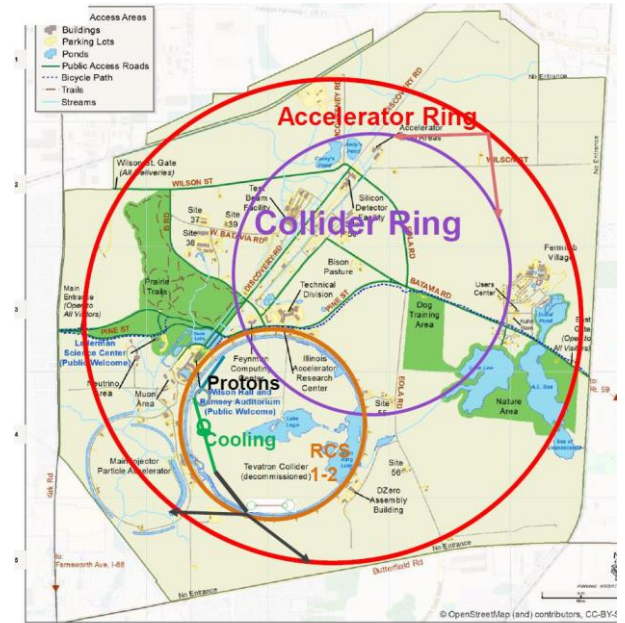

Parameter	ACE-BR Scenarios	MuC-PD Scenarios
Energy	8 GeV	8-20 GeV
Rep. Rate	10-20 Hz	5-10 Hz
Power	0.3-1.6 MW	1-4 MW
Proton Structure	25-40 e12 over 2 μ s ring	20-160 e12 in four 1-3 ns bunches

Example Path: ACE-Linac to Muon Collider (MuC)

Start with ACE-Linac v2 Configuration

That is **10 Hz x 5mA x 2ms x 8 GeV = 0.8 MW**

Upgrading to linac current **6-25mA**, we have **1-4 MW**.

Can we re-use the 8-GeV AR from ACE for MuC?

- MuC requirements are stricter than neutrino requirements.
 - Overdesign or re-build the 8-GeV AR?
- In the meantime any 8-GeV AR is useful for R&D.

MuC would also need an compressor ring, combiner, targetry.

- These upgrades could occur in stages in parallel with MuC R&D, construction, commissioning.

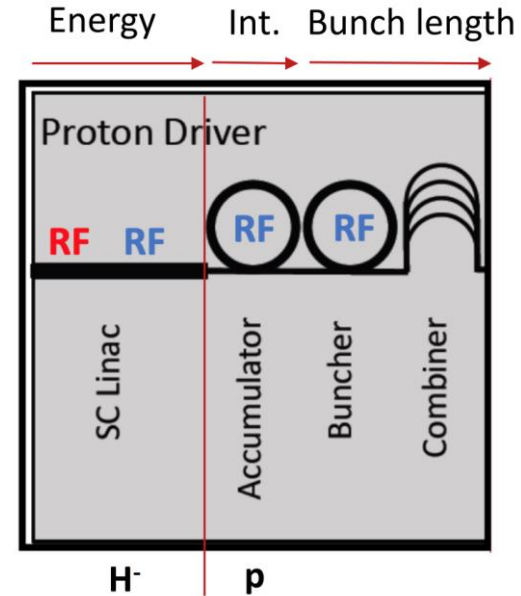

Backup Slides (Excerpts from HB2021)

Linac Upgrades & Studies

Recent Upgrades

- New Marx Modulators (2018)
- LEBT collimator.
- MEBT diagnostic package: bpm + toroid + halo monitor.

Upcoming

- Linac ML project: RF tuning + downtime prediction.
- Bunch length monitor.
- Moveable BLMs along low-energy DTL section.

Marx Modulator Cabinet



Booster Upgrades

Recent Upgrades

- “Wide Bore” RF Cavity installed
 - 2.25” -> 3.25” diameter bore.
 - 50 kV -> 60 kV RF cavity voltage
- IPMs calibrated for SC and ion effects. [paper.](#)
- Transverse stripline system with sub-ns resolution.
- New Ion Pumps.
- New BPM data acquisition system.

Upcoming (2022)

- Flat Injection
- New Digital LLRF system
- Improved Longitudinal Damper (reduced delay)
- New digital mode-2 longitudinal damper
- NPCT (new parametric current transformer)
- Gradient Magnet Power Supply (GMPS) ML regulation. [paper.](#)

Booster Flat Injection

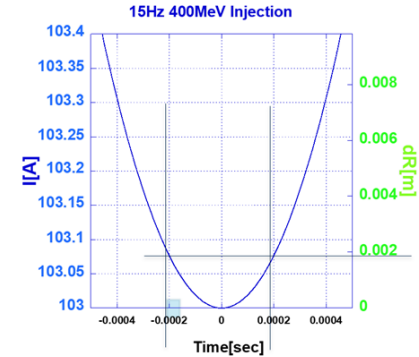

GMPS ML Model vs Status quo

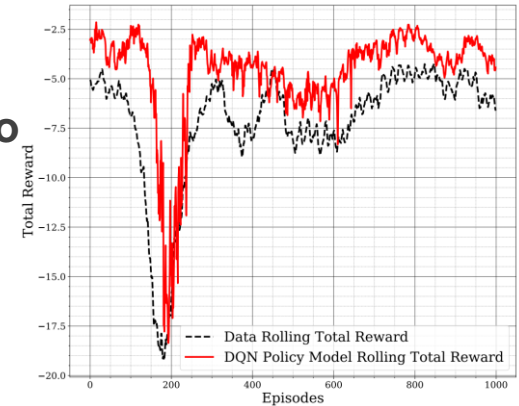

Booster Studies

Space-charge Emittance Growth. [paper](#).

2Qy Resonance Correction.

Investigation of possible Booster Electron Cloud.

Longitudinal RF Adiabatic Capture.

Transition-Crossing.

“Double-Notch” used to investigate ecloud

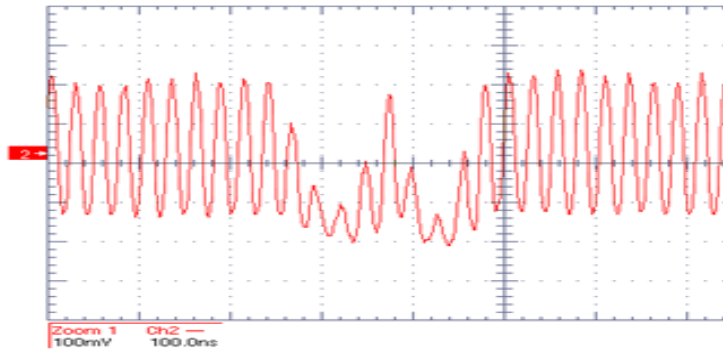

Booster 2Qy res. correction

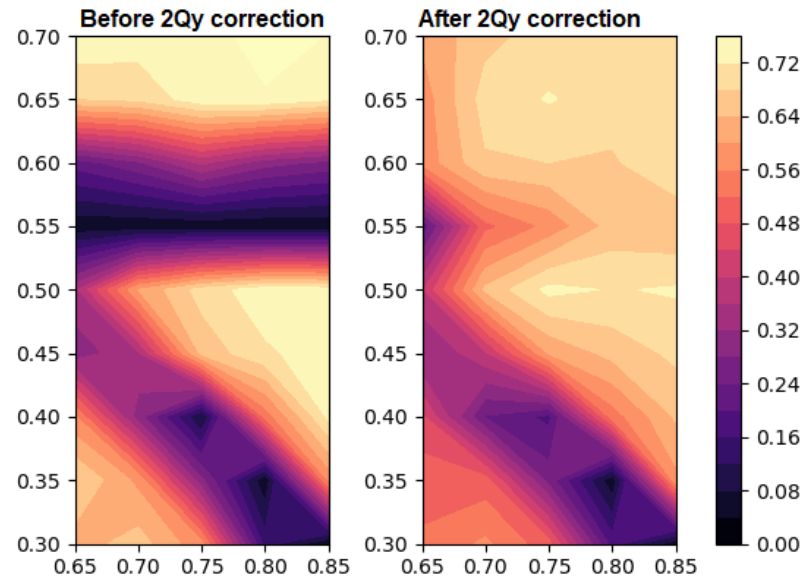

Recycler Ring / Main Injector, Studies & Upgrades

Main Injector

- Faster Main Injector cycle – demonstrated 1.333 s \rightarrow 1.2 s
- ML study to distinguish losses in Recycler and Main Injector

Recycler Ring

- Corrected optics to reduce beta-beating.
- Sextupoles installed to correct $3Q_x$ and $3Q_y$ resonances.
- Demonstrated “off-momentum” slip-stacking to reduce momentum span during slip-stacking operations (for PIP-II).
- Controlled excitation of convective instability in Recycler.
 - 2020 DOE Early Career Award: Robert Ainsworth

Recycler Resonances

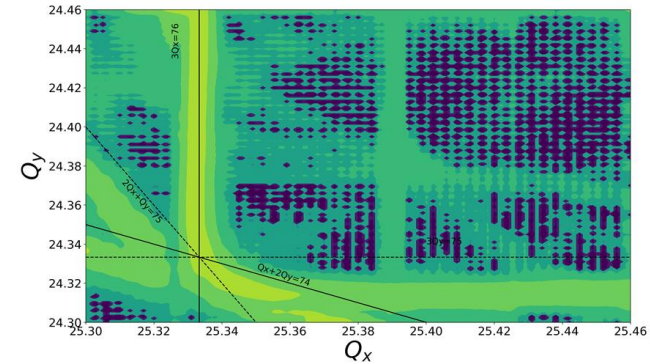

Convective Instability

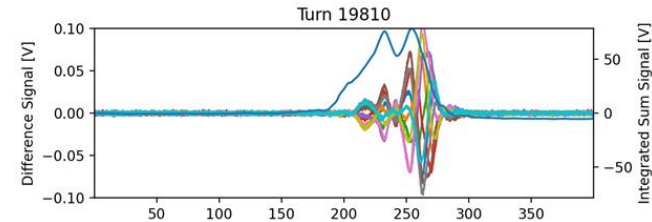

800 MeV SRF Linac Is At Heart of the PIP-II Project

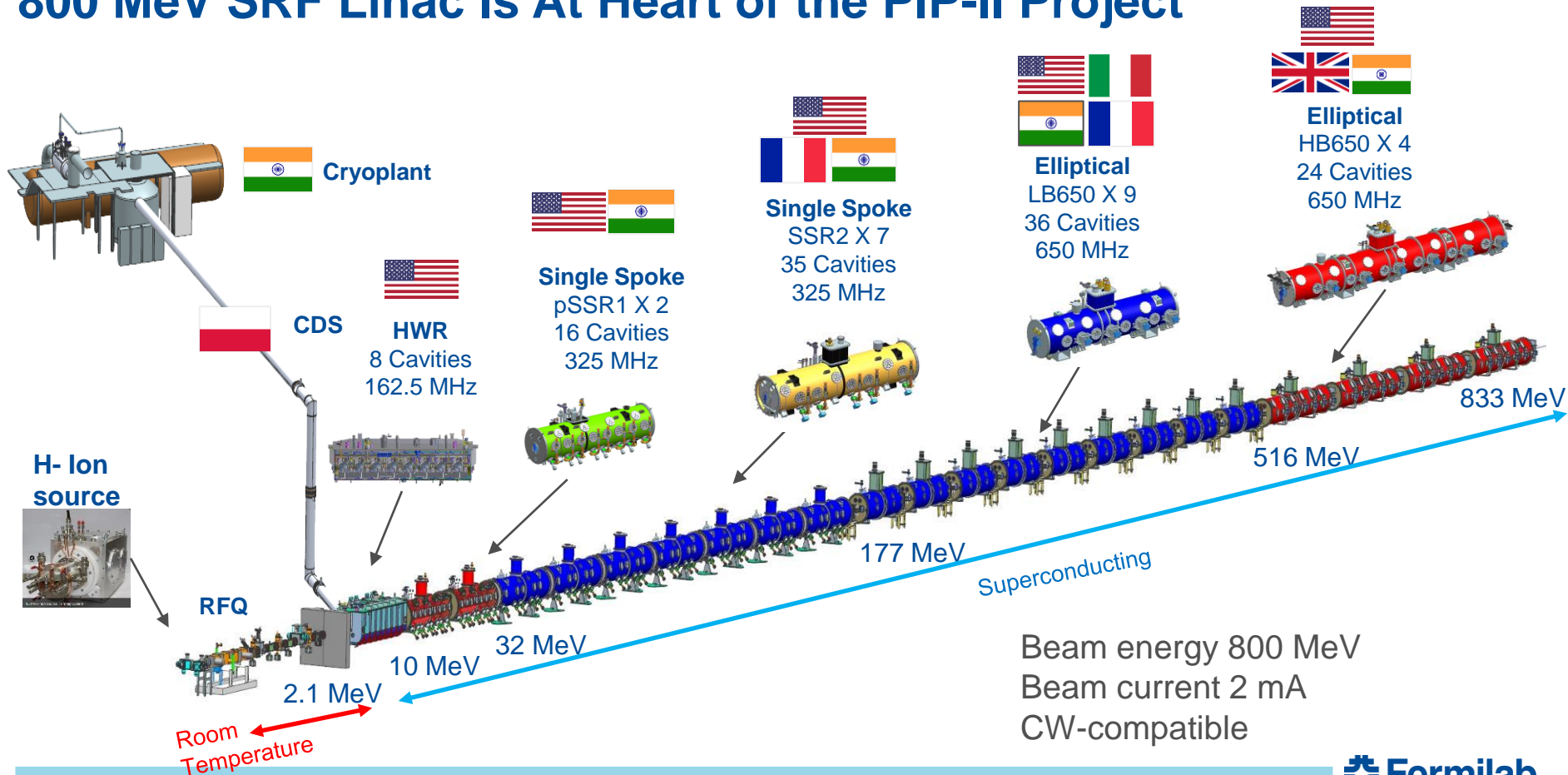

PIP2IT Successfully Commissioned With Beam

Beam with LBNF parameters demonstrated

Parameter	Demonstrated Value
Energy	16.5 MeV
Beam current	2 mA
Pulse length	550 μ s
Pulse rep. rate	20 Hz
Bunch Pattern	Chopped with "Booster pattern"

Chopped beam pattern
measured at 16.5 MeV
Booster pattern.
Extinction $\sim 10^{-3}$

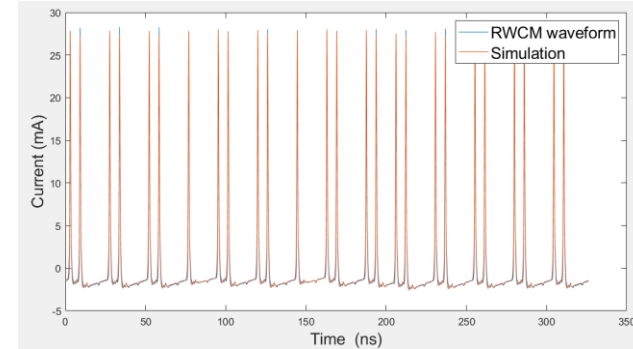

550 μ s long beam pulse
Accelerated to 16.5 MeV

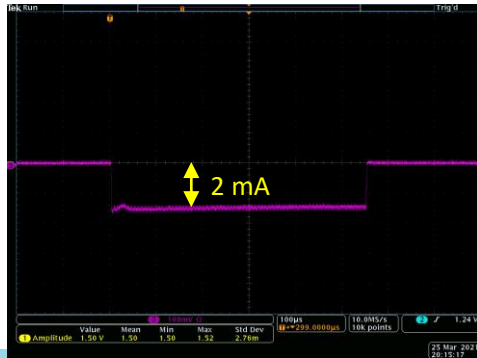

Beam energy along PIP2IT.
Measured (circles) vs
simulated (blue curve)
First three HWR cavities
were not operational.

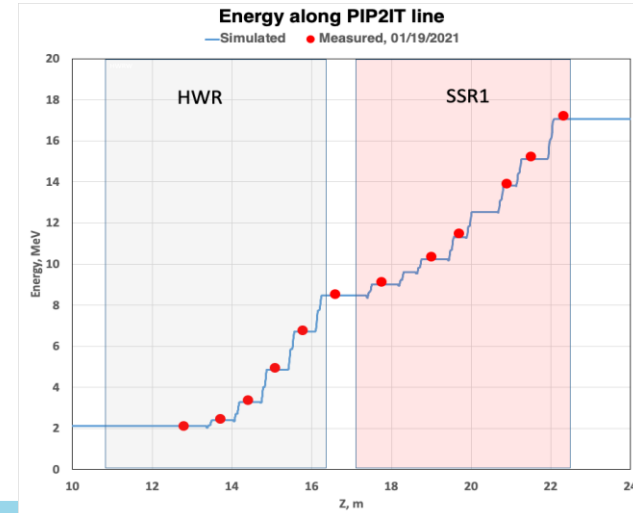

Fermilab Superconducting RF Cavity Activities

Frontier Projects

- PIP-II
- LCLS-II, LCLS-II-HE (including cryomodule production)
- HL-LHC AUP (crab cavities)

Leading R&D Activities

- High Q_0 development (e.g. doping of superconductor)
- High gradient with high Q_0 R&D (e.g. multi-step bake)
- New materials (e.g. Nb_3Sn)

Spin-offs from Scientific Accelerator R&D

- Industrial accelerator development (e.g. conduction cooling)
- High coherence quantum systems (quantum computing, sensing)

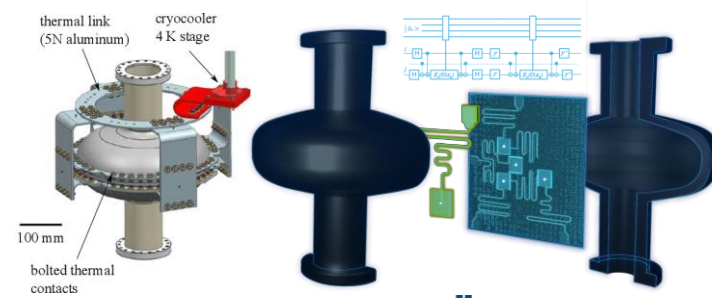
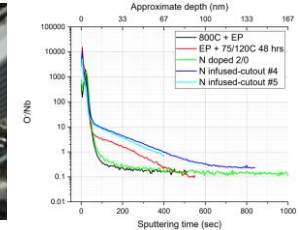

Fermilab SC magnet projects and R&D

Current Frontier Projects

Mu2e transport solenoid
HL-LHC AUP IR quadrupoles



Nb₃Sn Conductor R&D

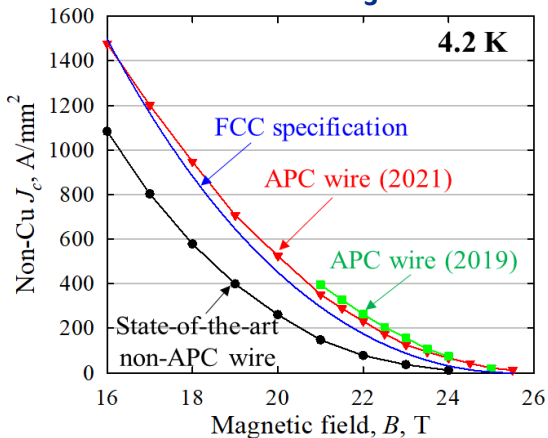

High field magnets for application in HEP will require high performance SC. A new Nb₃Sn conductors based on the Artificial Pinning Center technology, has been developed and achieved world-leading results with wires surpassing FCC specifications.

Magnet R&D

The field levels achieved in dipole model MDPCT1 at 4.5 K and 1.9 K set *new world records for Nb₃Sn accelerator magnets*

$$B_{\max} = 14.5 \text{ T @ 1.9 K}$$

MDPCT1 field

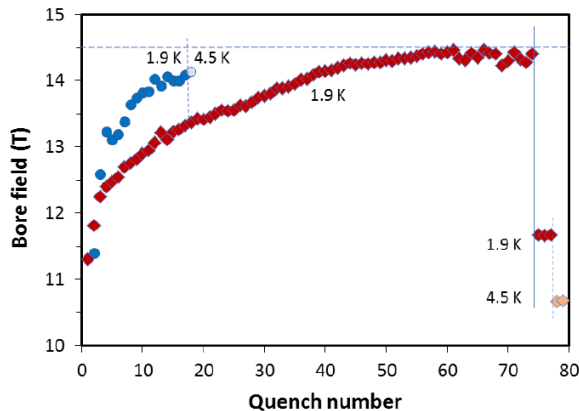

MDPCT1



Fermilab Fast-ramping Super-ferric Magnets

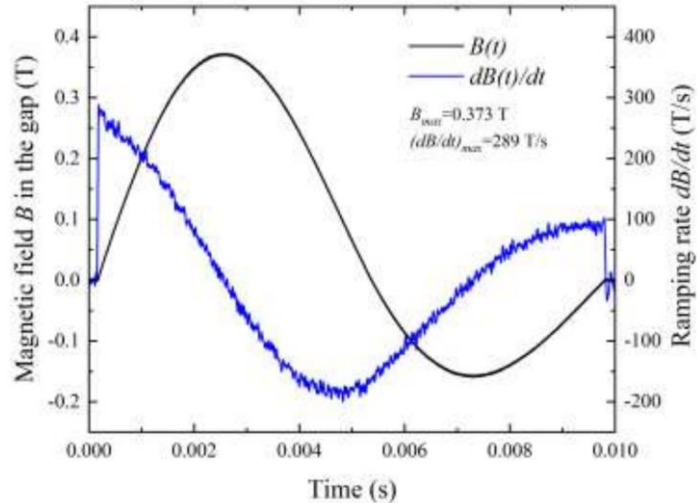
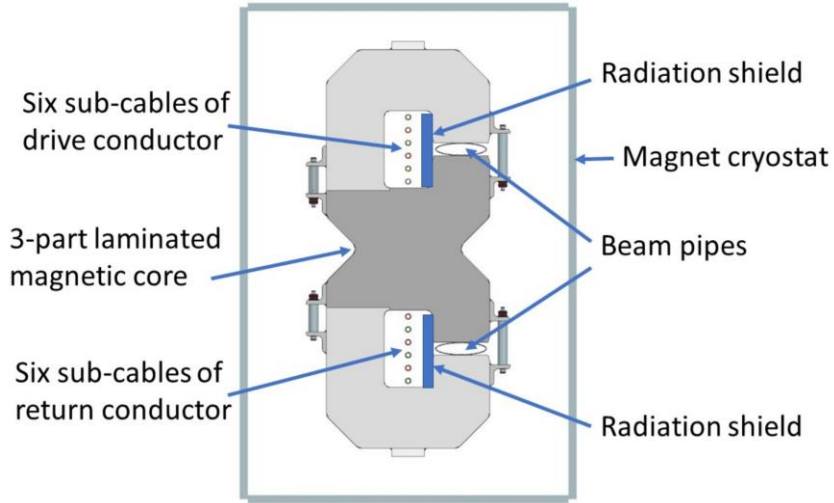

YBCO-based HTS super-ferric dipole demonstrated >300 T/s. [paper](#).

Appropriate technology for a fast-ramping ultra-compact RCS.

- Less circumference required for extraction energy \rightarrow RF power more efficient.
- More aperture at required field strength \rightarrow greater beam intensity.

FAST/IOTA: Accelerator R&D Facility at Fermilab

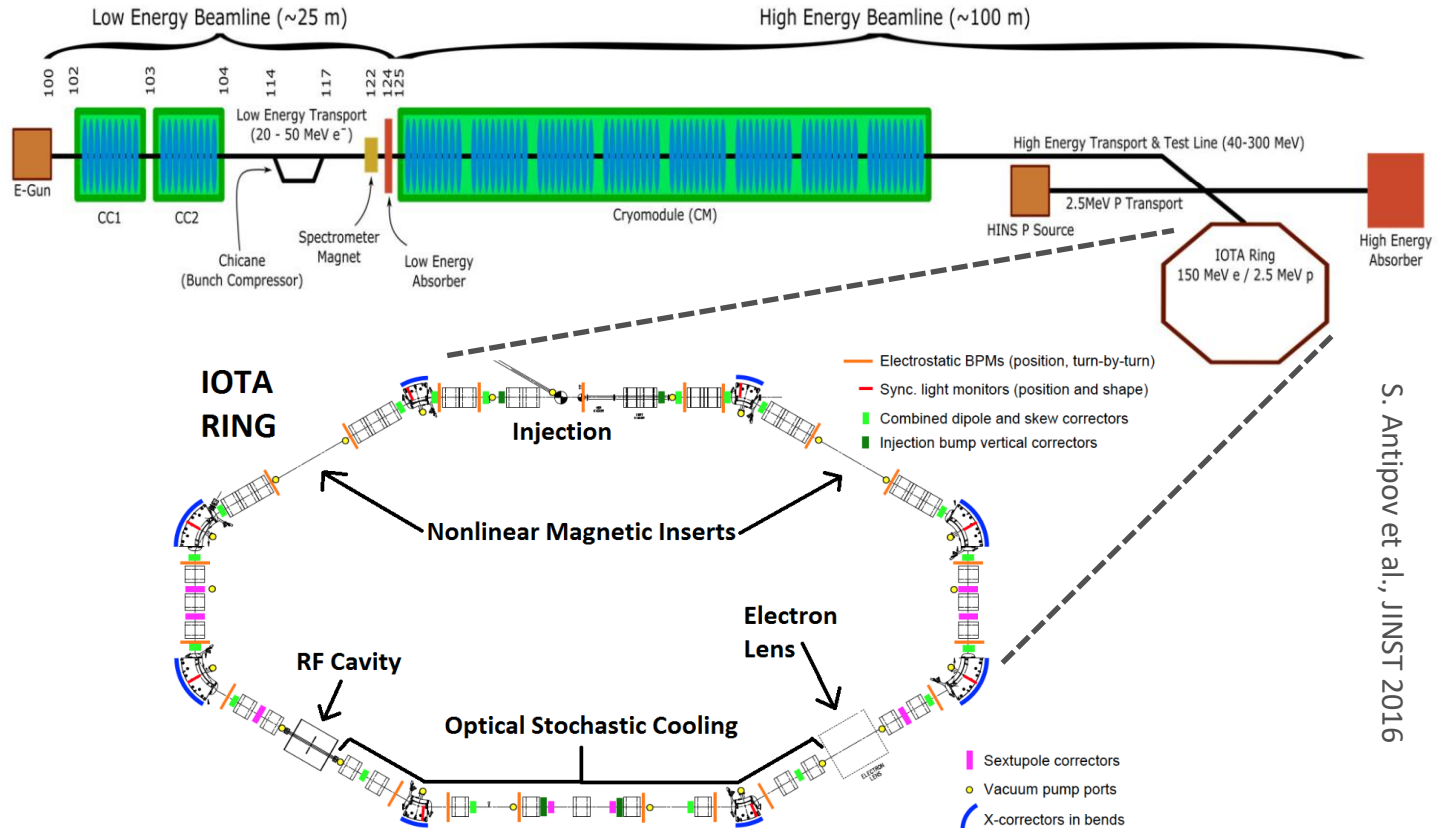

S. Antipov et al., JINST 2016

FAST/IOTA Developments

Recent (Run 2)

- First Demonstration of Optical Stochastic Cooling
 - 2020 DOE Early Career Award: Jonathan Jarvis
- Nonlinear Integrable Optics with e- beam.
- Single-Electron Radiation Studies

Upcoming

- 2.5 MeV Proton Injection into IOTA
- Nonlinear Integrable Optics with p+ beam.
- Electron Lens Studies.

Coming up soon!

[2021 FAST/IOTA Collaboration](#) meeting on Oct 27th.

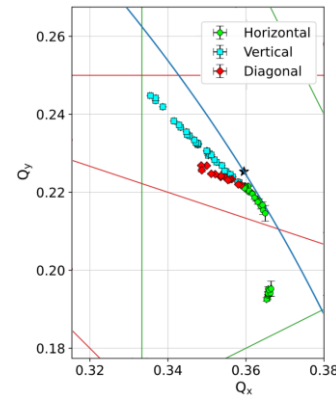

Tunes from Nonlinear Integrable Optics

Synchrotron light from single electron

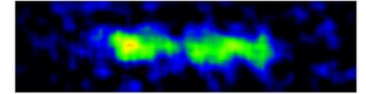

Electron Lens at IOTA

