

# Devices for High-Efficiency Slow Extraction at J-PARC Main Ring

R. Muto  
KEK / J-PARC

2023-Oct-13  
HB2023

# Outline

---

- Slow Extraction at J-PARC Main Ring
- Devices for Slow Extraction
  - Electrostatic Septum (ESS)
  - Beam Diffusers at the upstream of ESS
  - Beam Collimators at the downstream of ESS
- Future plans
- Summary

# J-PARC

Japan Proton Accelerator Research Complex

400MeV  
LINAC

3GeV  
RCS

MLF

3rd Order Resonant  
Slow Extraction

30 GeV  
Main Ring

Hadron  
Experimental  
Facility

$\nu$  to  
SK

MR Params. in Slow Extraction	
Circumference	1567.5 m
Kinetic Energy	30 GeV
Betatron tune	(22.333, 20.78)
Repetition	5.2 sec
Spill Length	~2 sec

Bird's eye photo  
in January 2016

# Slow extraction at J-PARC MR

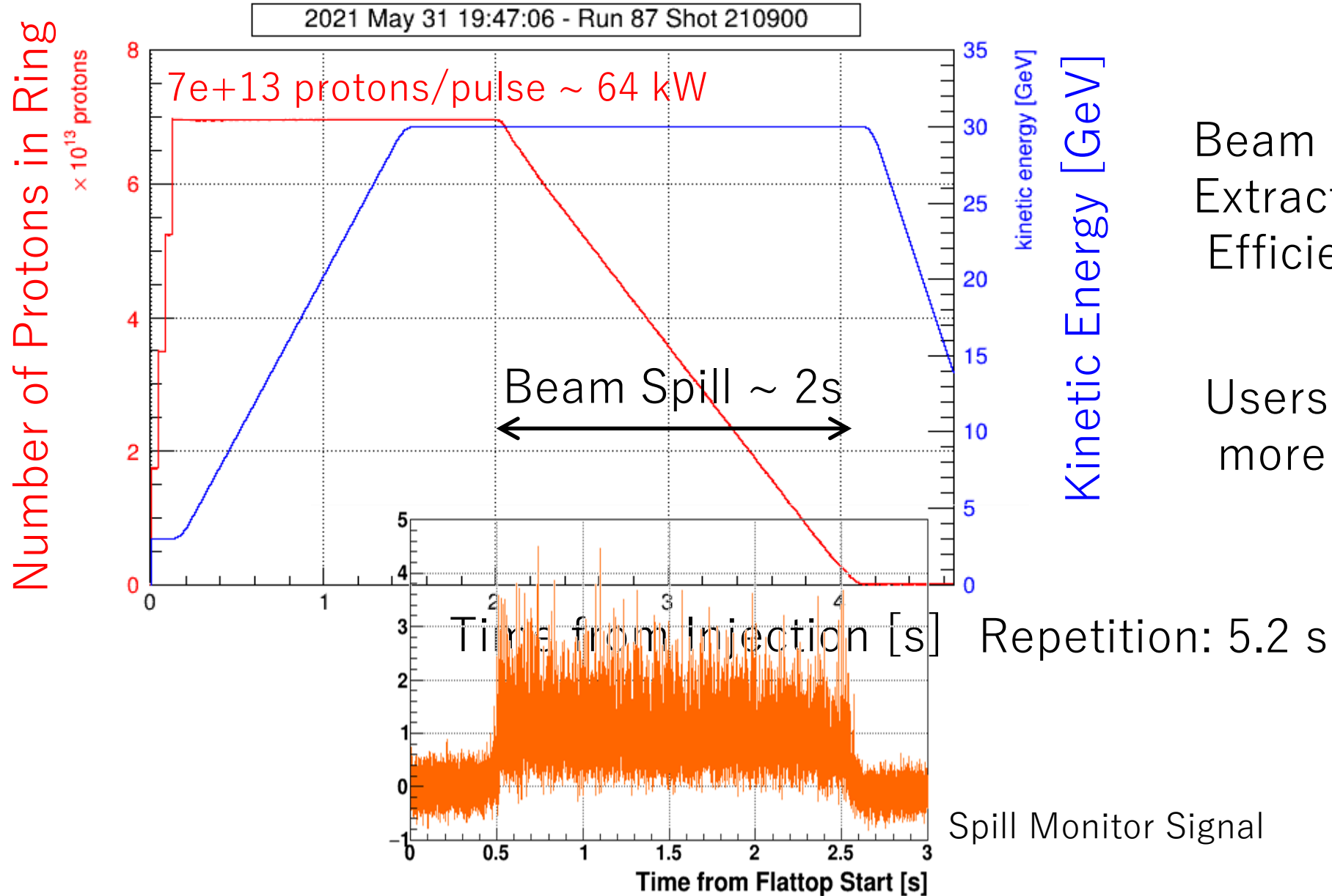

Beam Power: 64 kW  
Extraction  
Efficiency:  $\sim$ 99.5%

Users need  
more beam power

# Straight Section for Slow Extraction

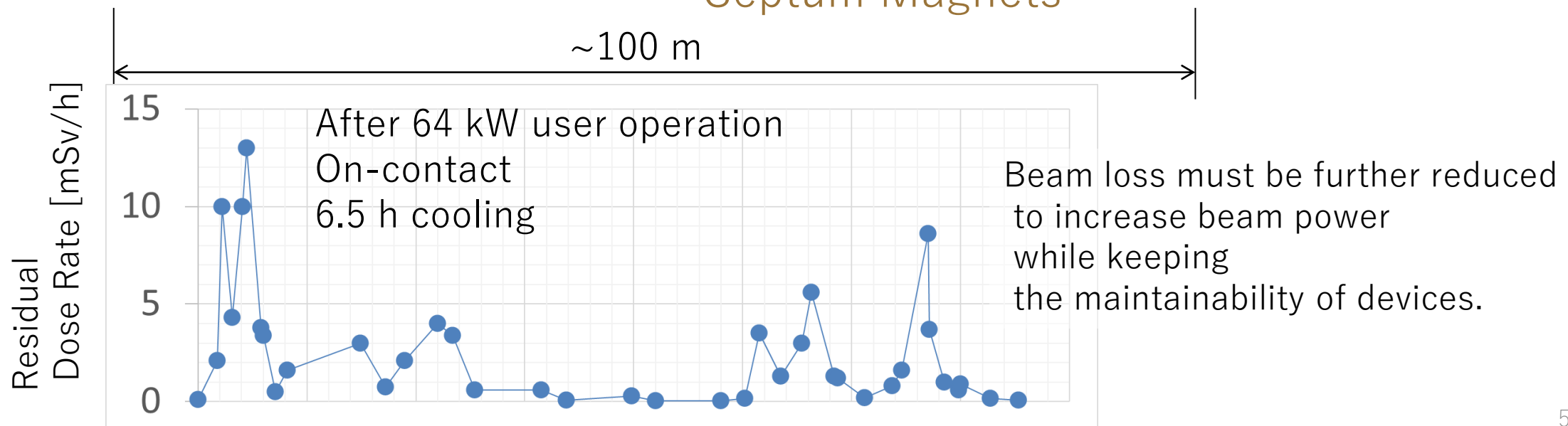
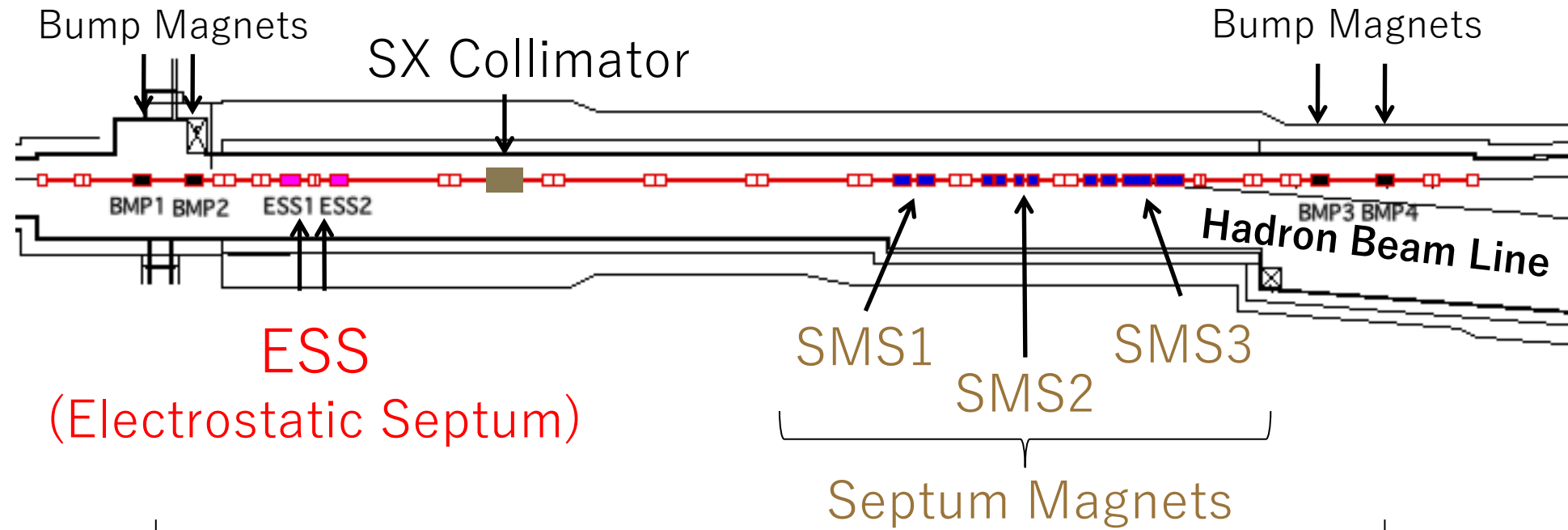

# Electrostatic Septum (ESS)

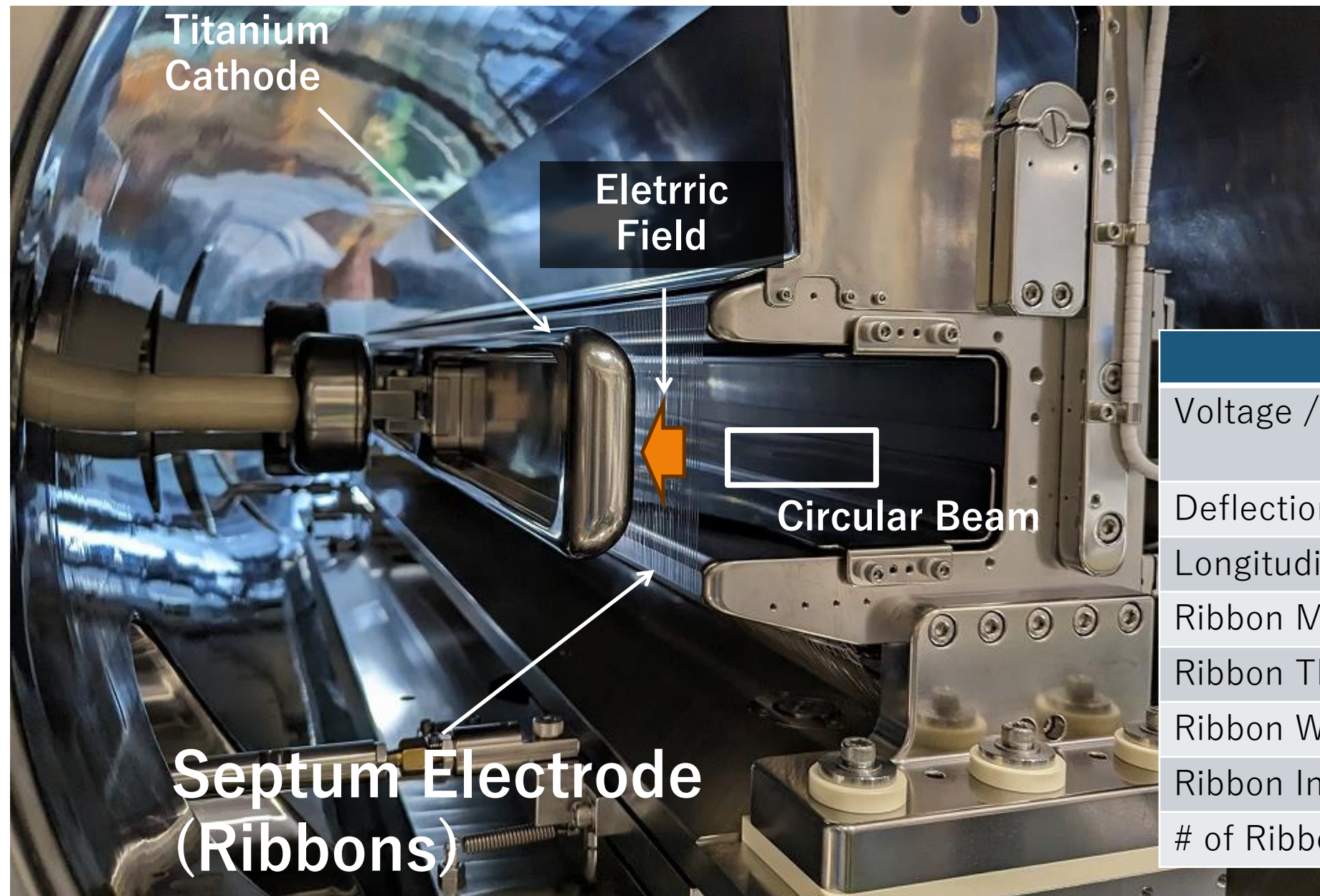

	ESS1,2
Voltage / Gap	104 kV / 25 mm = 4.2 MV/m
Deflection Angle	- 0.2 mrad
Longitudinal Length	1.5 m
Ribbon Material	W-26 Re
Ribbon Thickness	30 $\mu$ m
Ribbon Width	1 mm
Ribbon Interval	3 mm
# of Ribbons	495

# Straight Section for Slow Extraction

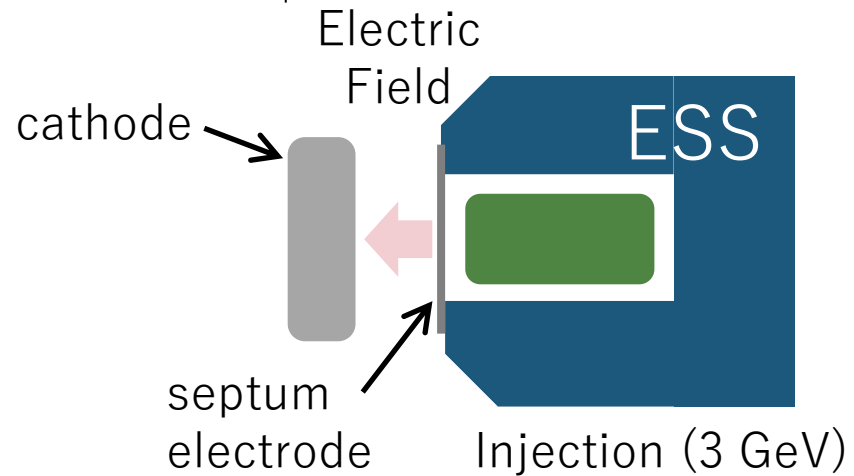
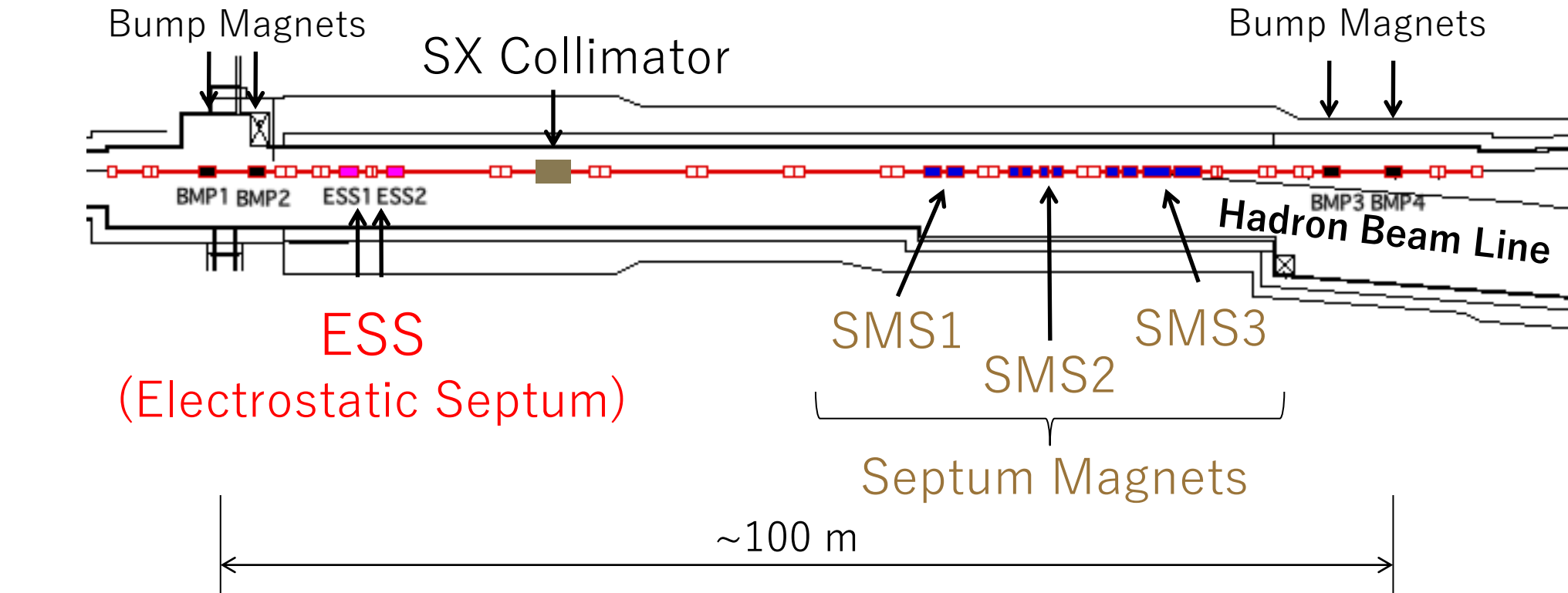

# Straight Section for Slow Extraction

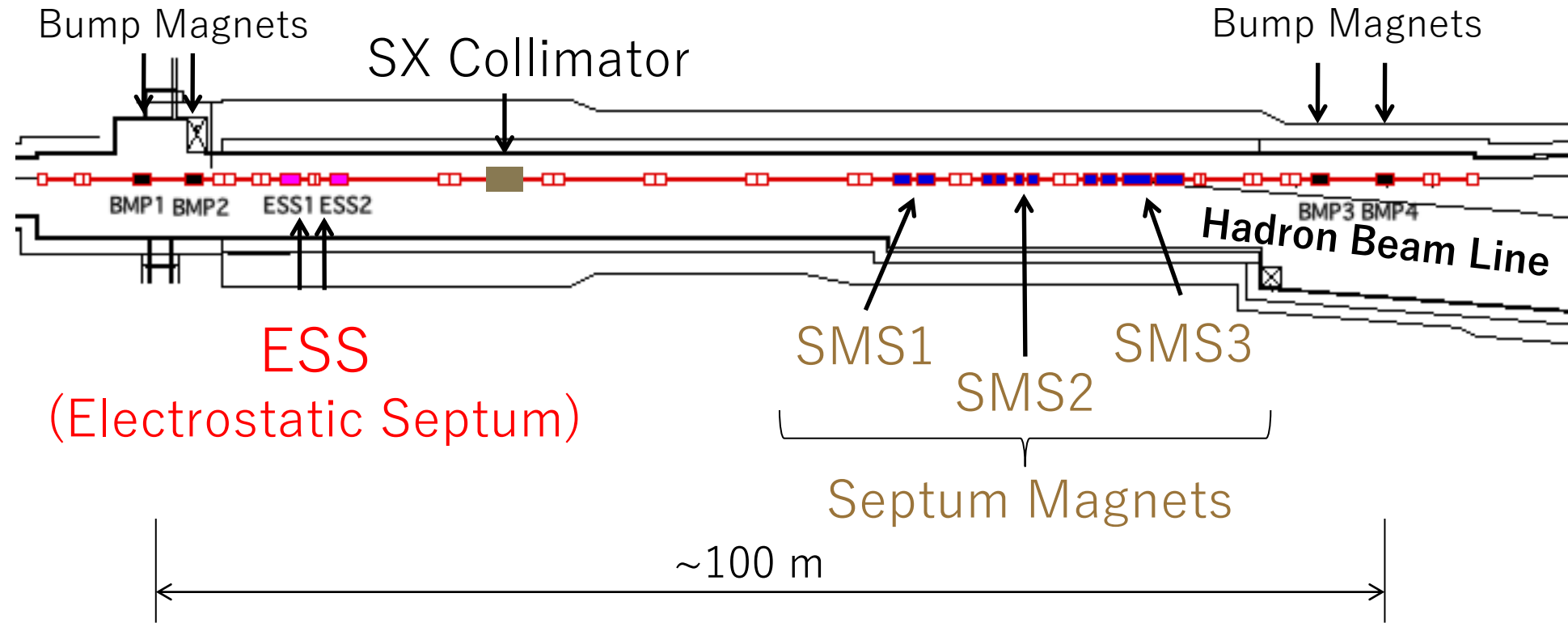

ESS  
(Electrostatic Septum)

SMS1  
SMS2  
SMS3  
Septum Magnets

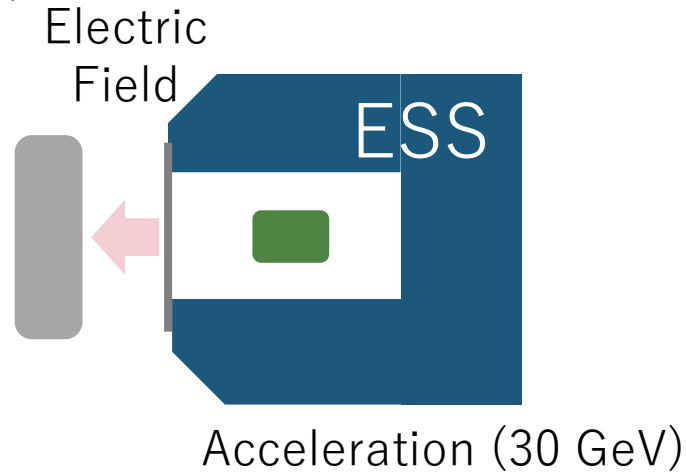
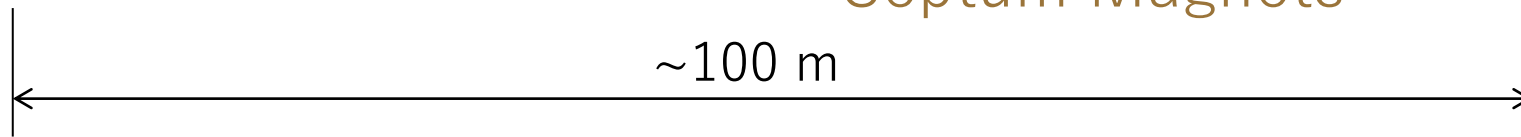



# Straight Section for Slow Extraction

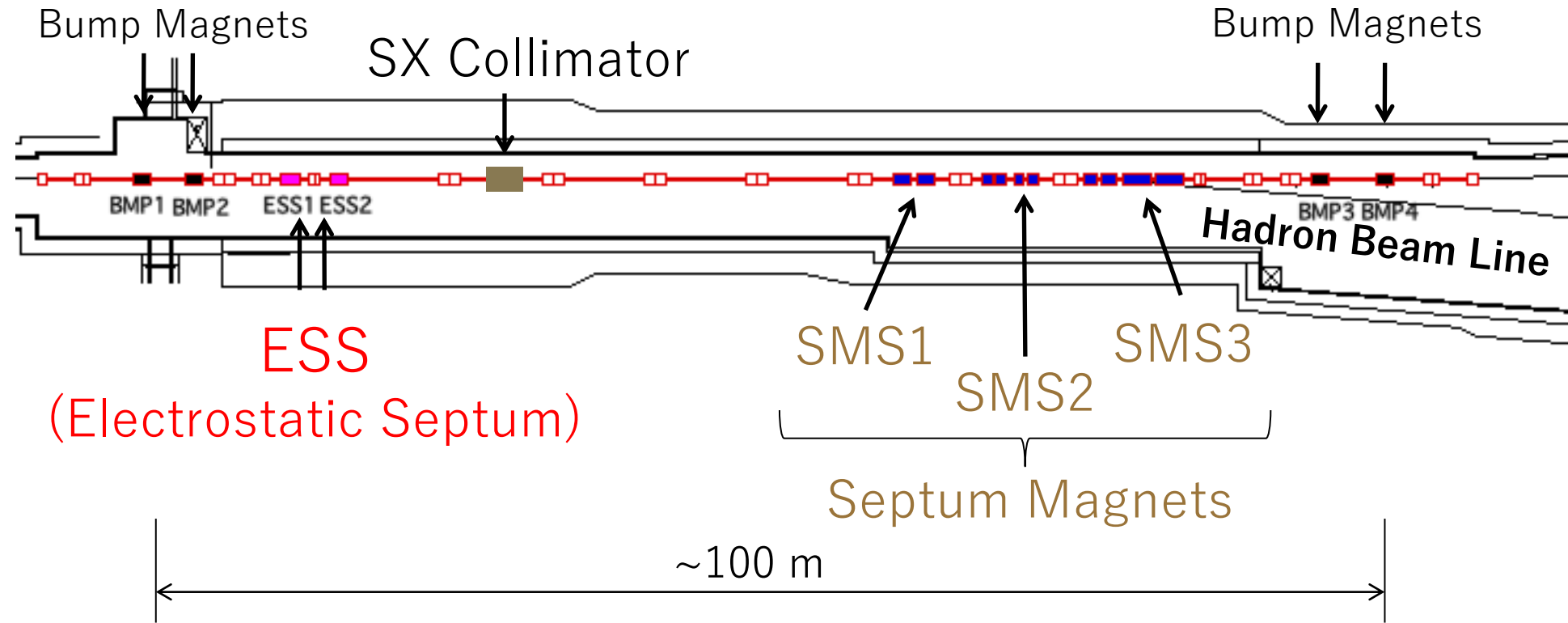

ESS  
(Electrostatic Septum)

SMS1  
SMS2  
SMS3  
Septum Magnets

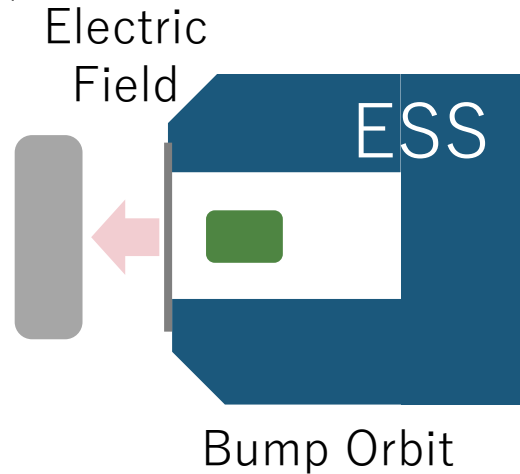
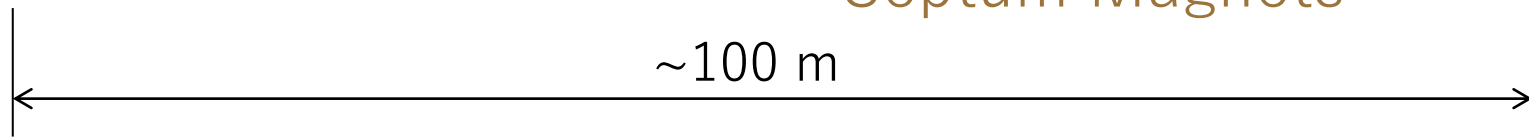

# Straight Section for Slow Extraction

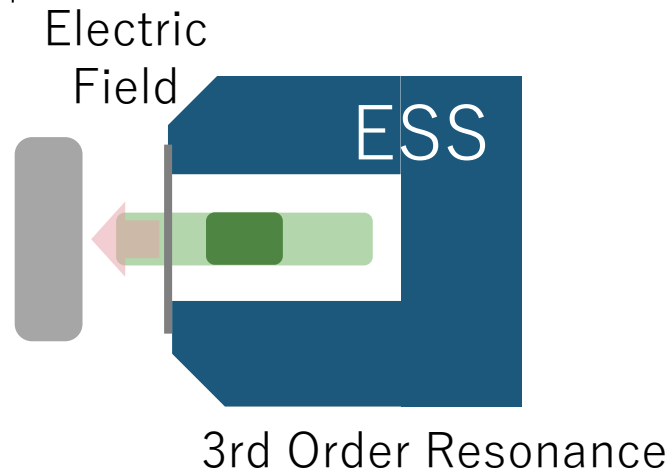
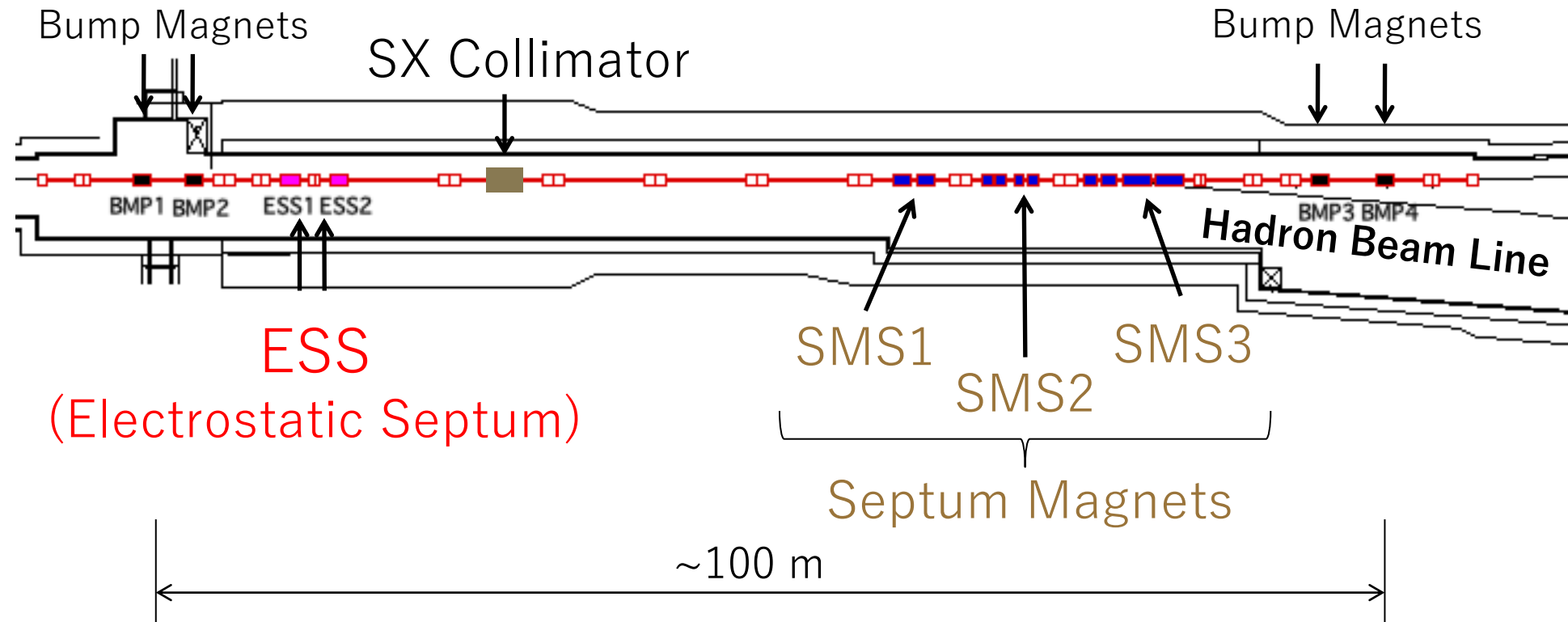

Beam loss at the septum electrode is inevitable

- How to reduce the beam loss at ESS
- How to localize the radioactivation

are the main issues in the slow extraction

# Particle motion with third order resonance

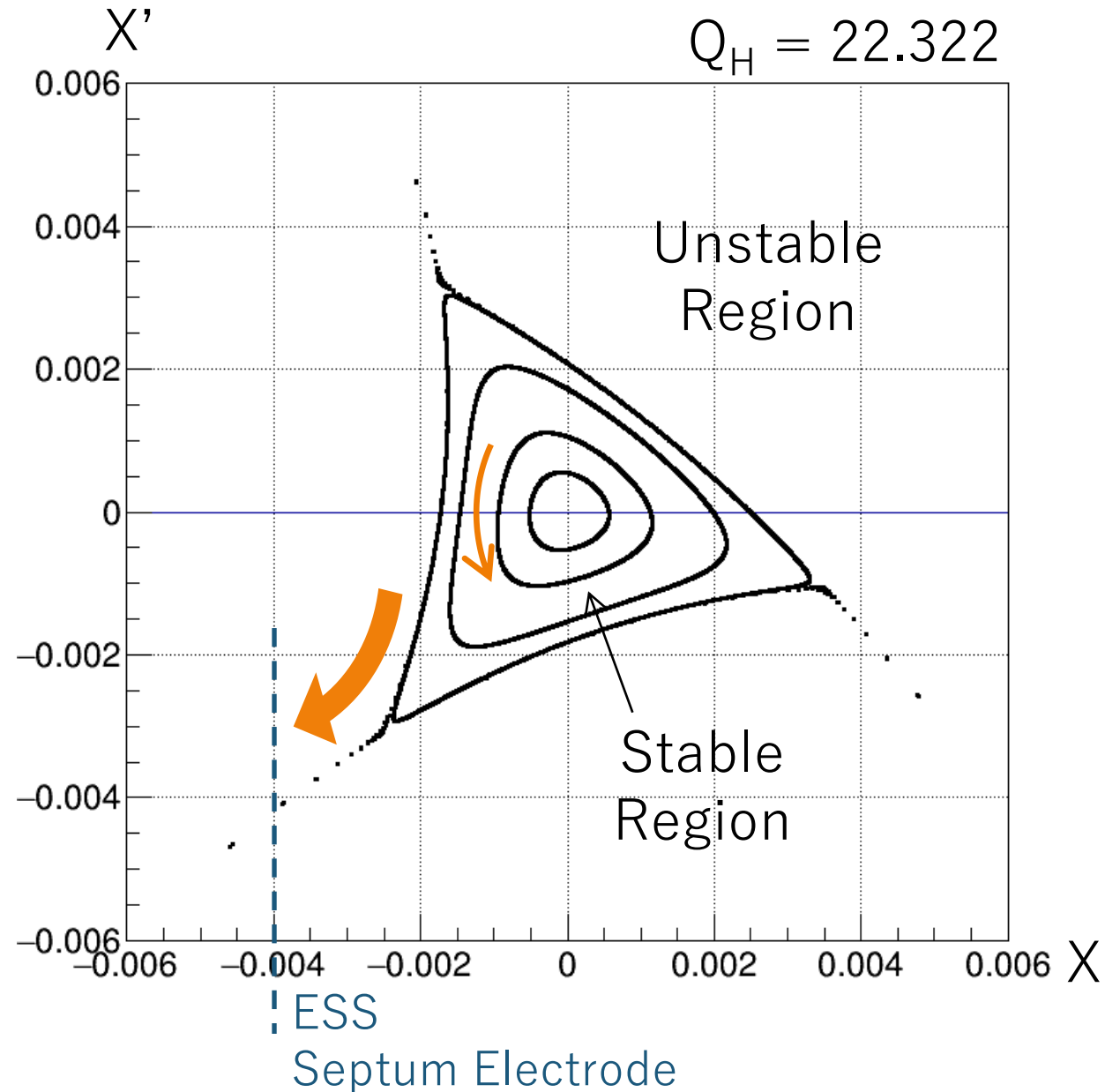

3rd order resonance is excited using 8 sextupole magnets distributed in the MR

Phase space is separated into stable and unstable regions

Particles in the unstable region increase their amplitude and are finally kicked by the ESS.

# Dynamic Bump Scheme

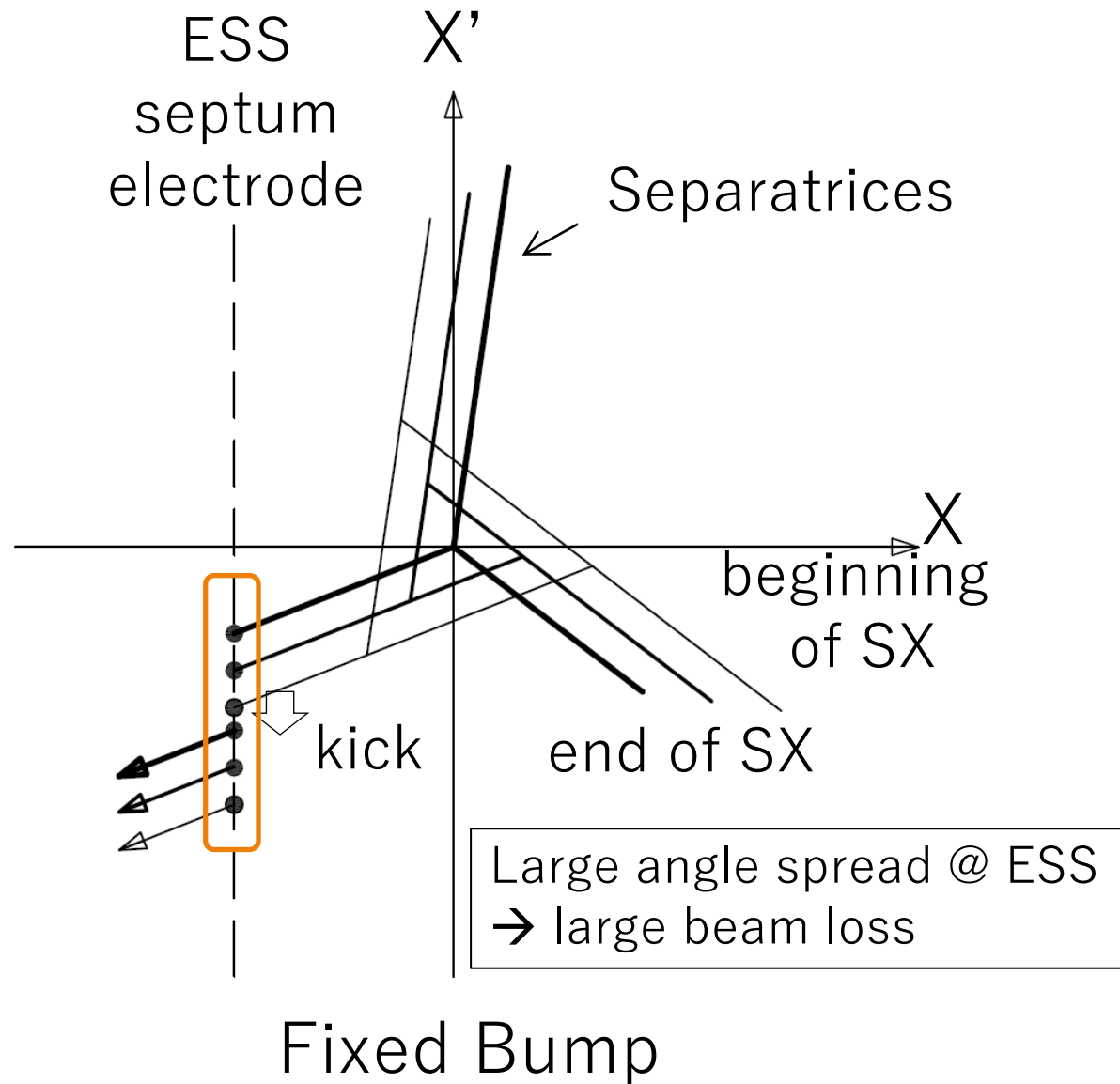

We gradually ramp the horizontal betatron tune closer to 22.333 and reduce the stable area

If the bump orbit remains fixed, the particles have a large angle spread when they reach the septum electrode.

This causes large beam loss at the septum electrode.

# Dynamic Bump Scheme

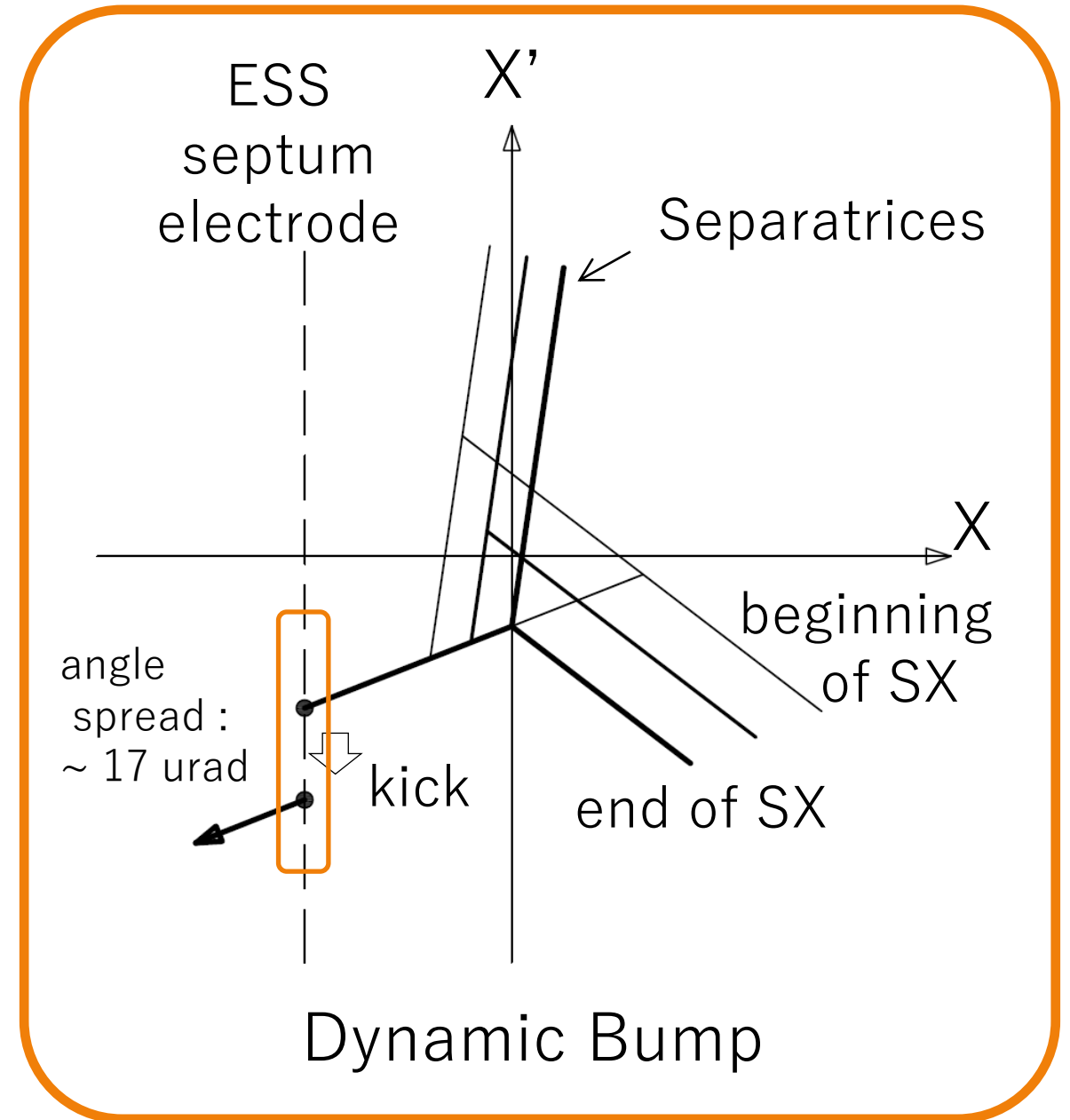
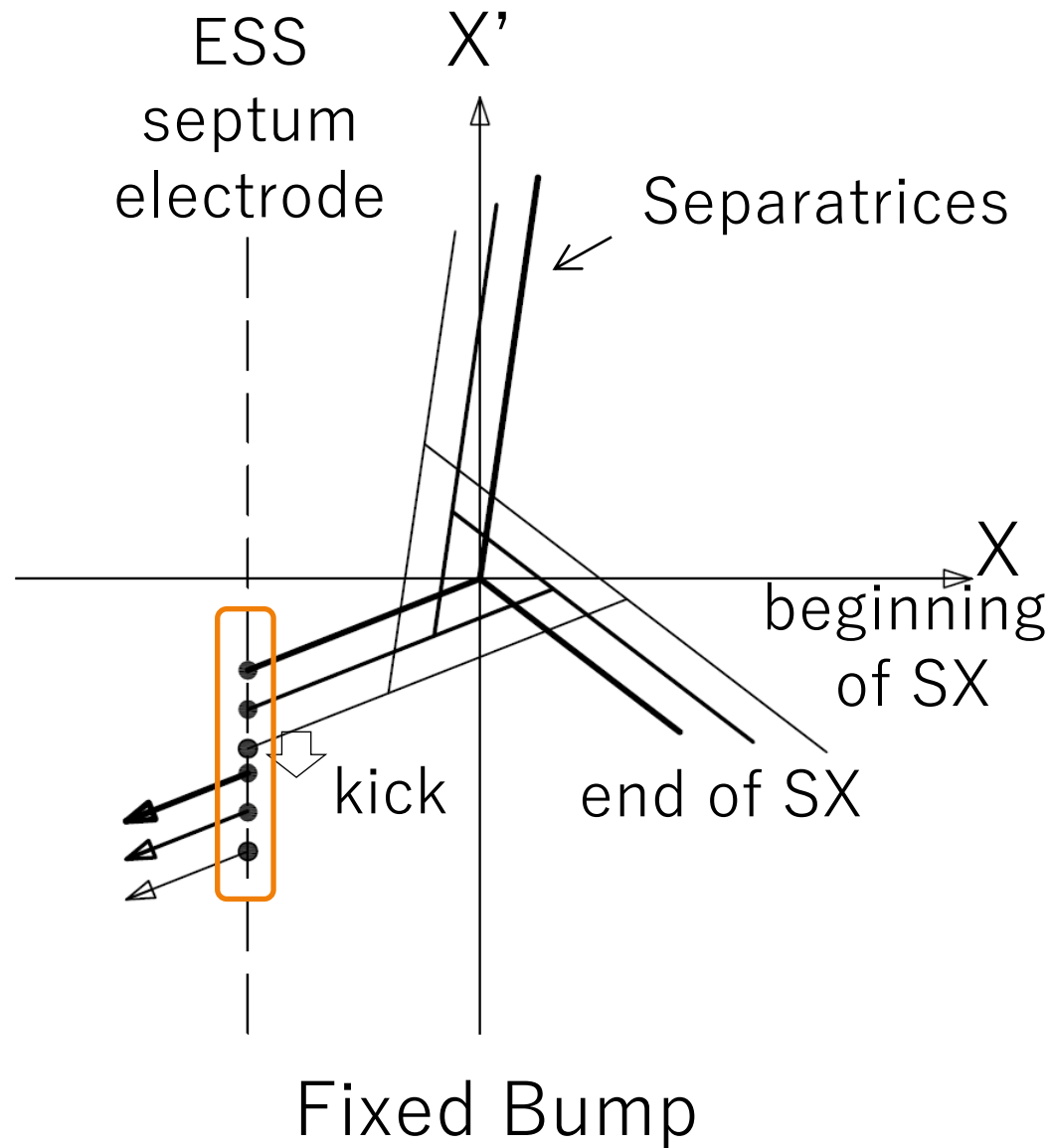

# Devices for Slow Extraction

- 1) Electrostatic Septum

# Electrostatic Septum (ESS)

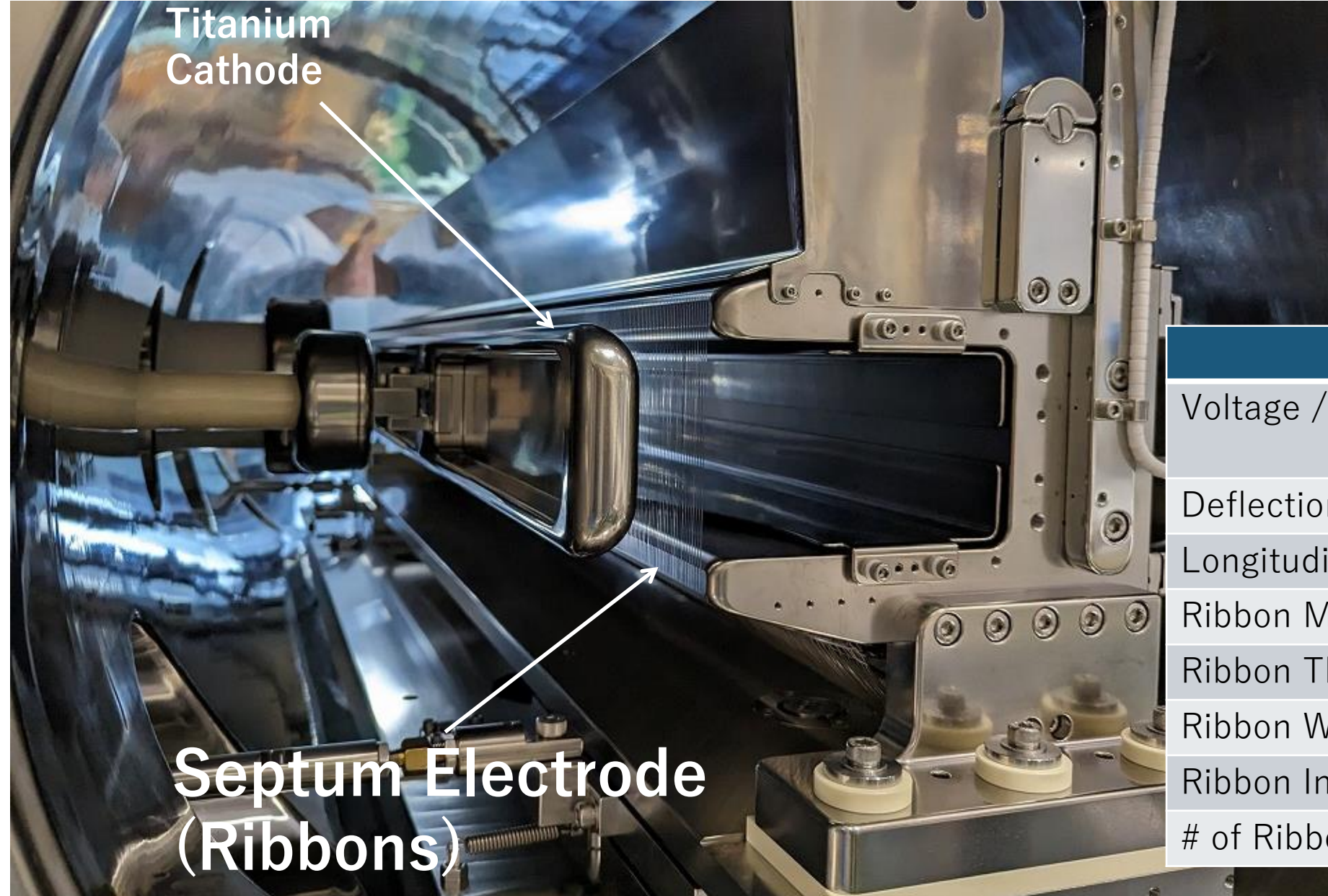

	ESS1,2
Voltage / Gap	104 kV / 25 mm = 4.2 MV/m
Deflection Angle	- 0.2 mrad
Longitudinal Length	1.5 m
Ribbon Material	W-26 Re
Ribbon Thickness	30 $\mu$ m
Ribbon Width	1 mm
Ribbon Interval	3 mm
# of Ribbons	495

# Why Ribbons?

---

Making the septum thin is important to reduce beam loss.

With the ribbon shape, it is possible to increase the cross-section area and the breaking load while reducing the thickness of the septum.

The ribbons are pulled by springs with loads of 1 kgf

- To reduce ribbon deflection due to electric field
- To quickly pull out the ribbon when it breaks

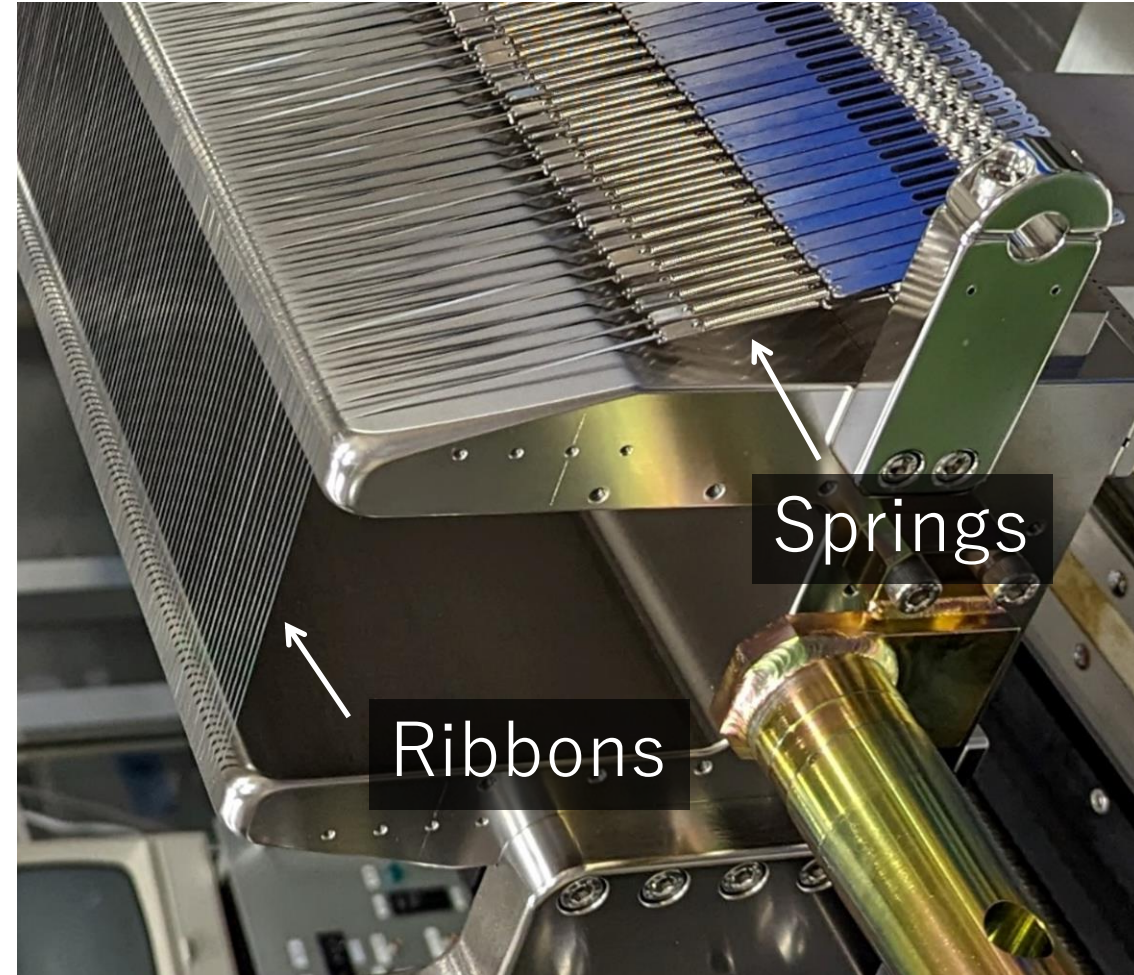



# Ribbons for Septum Electrode



Material: W-26 Re  
Made by rolling & annealing

Tensile strength test of the manufactured ribbons  
Breaking load: 4~4.5 kgf  
→ satisfy the requirement

## Cross section



1 mm

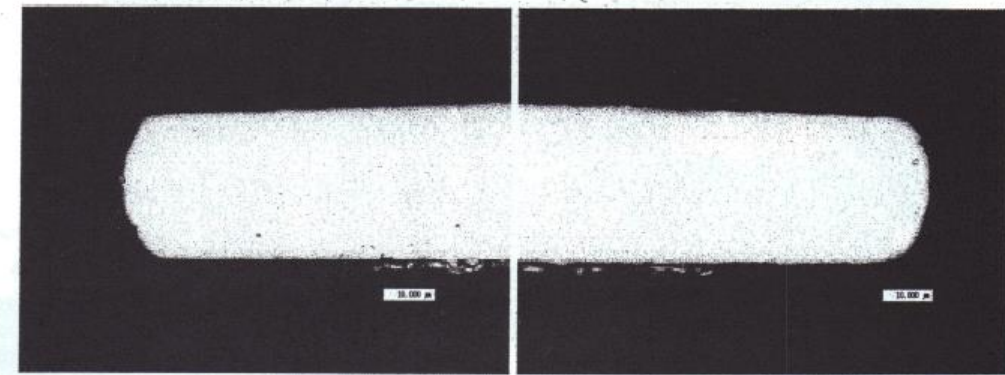

30 μm

Electrolytic polished to  
remove burrs

# Alignment of the Ribbons

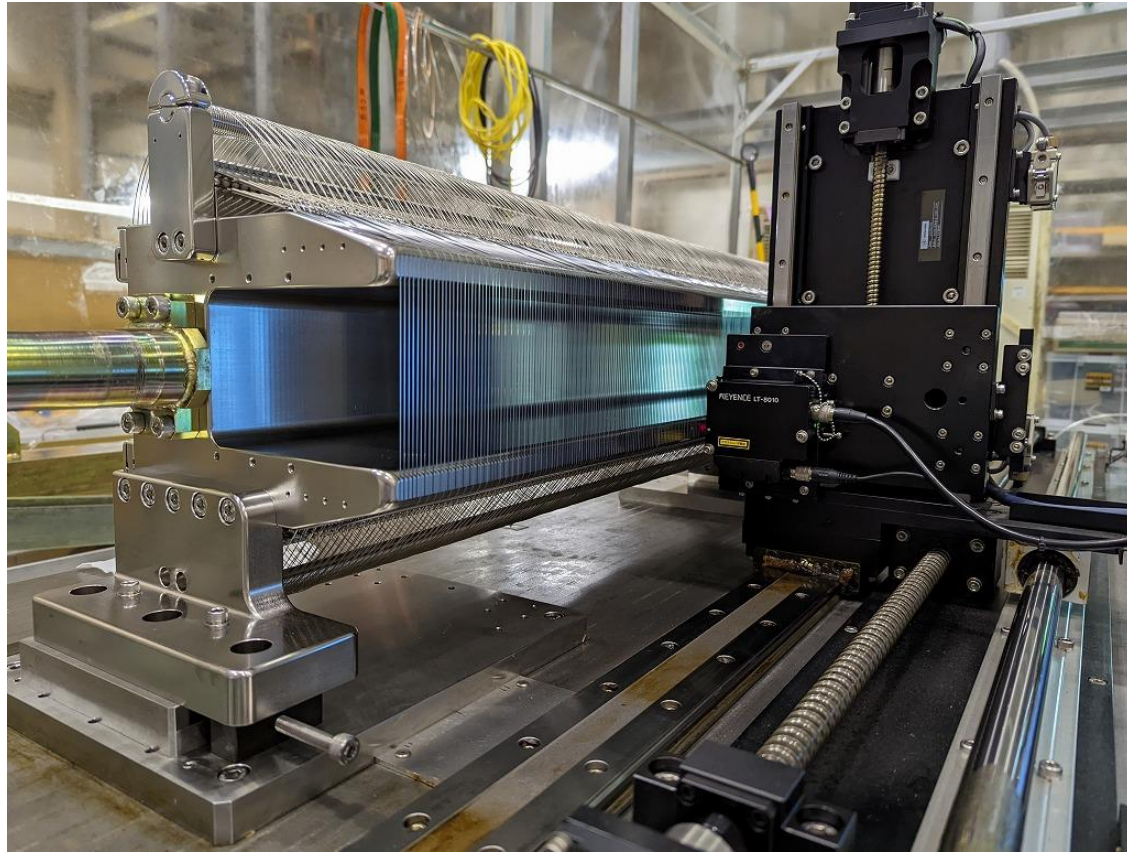

We measured the positions of the ribbons using a laser displacement sensor

We replaced the ribbons that were twisted or misaligned

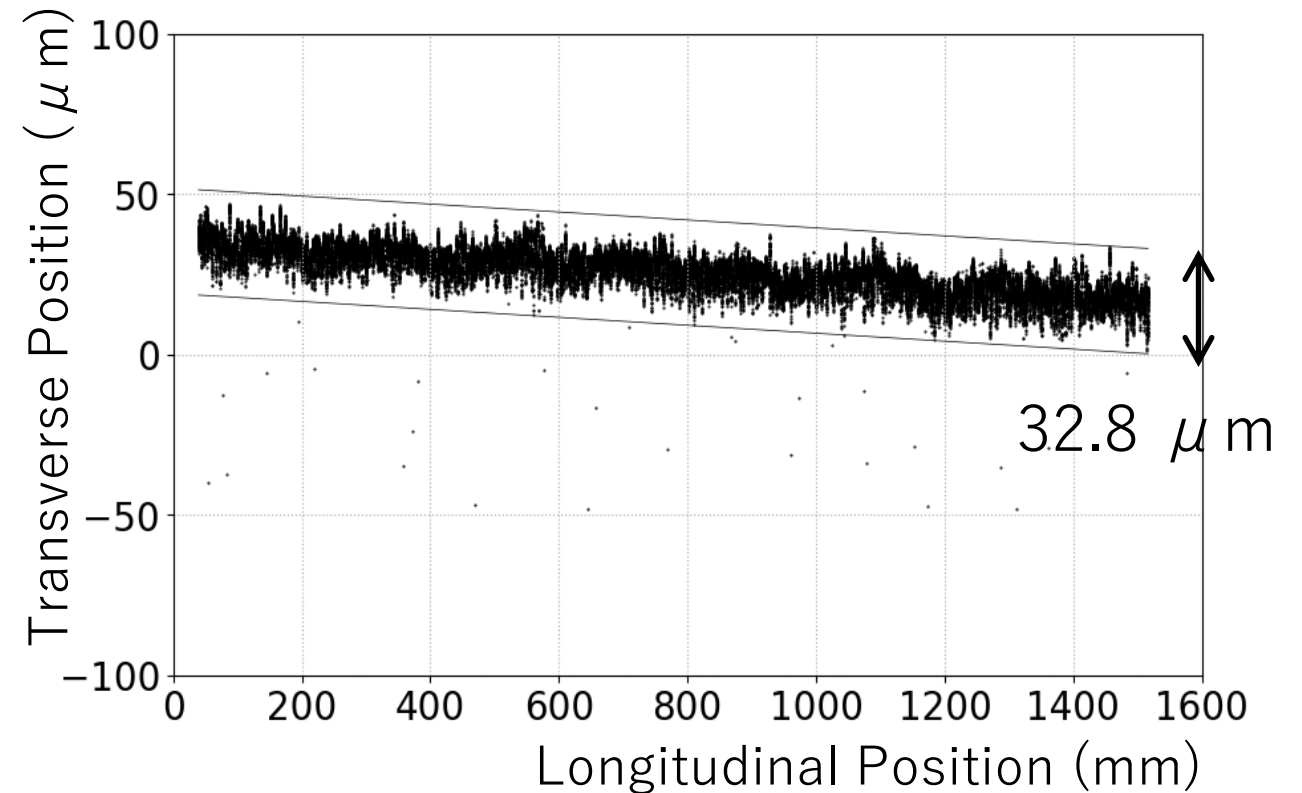

# Energy Deposit on Ribbons

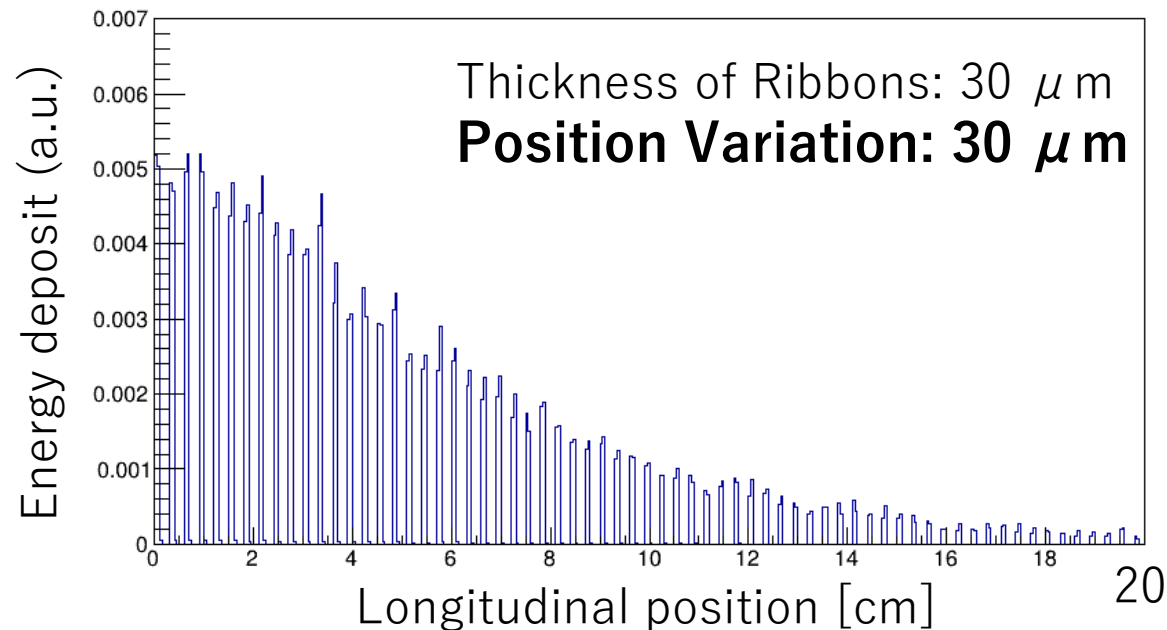
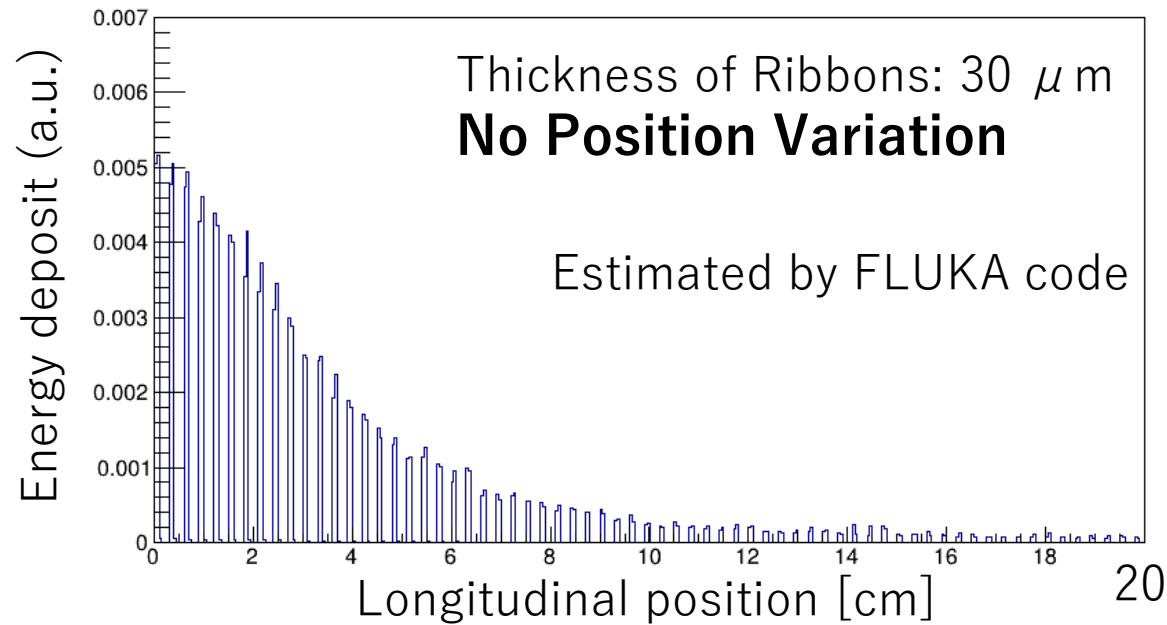

Reference:  
If they are not thin ribbons  
but 200cm x 200cm x t 1mm boards  
lined up every 3 mm

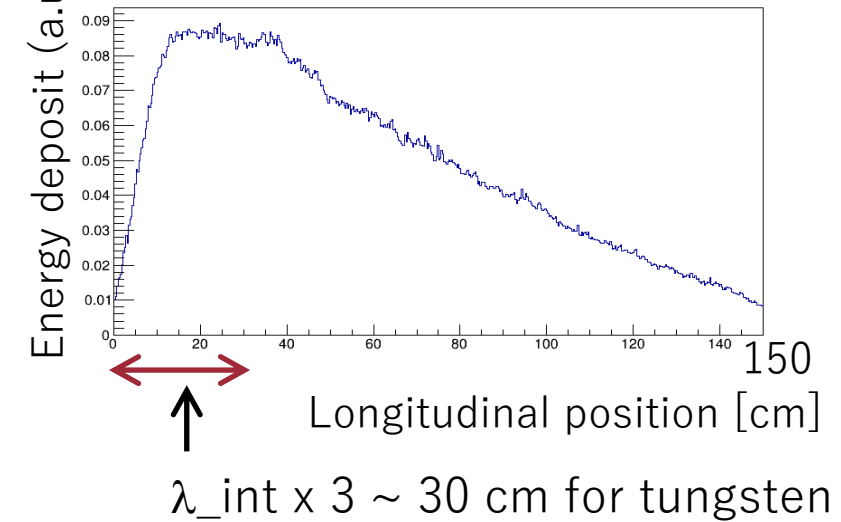

Temperature rise of the most upstream ribbon  
with 100 kW beam:

- 1 pulse with no cooling  $\rightarrow \Delta T = \sim 160 \text{ }^\circ\text{C}$
- Thermal equilibrium: at  $T = 227 \text{ }^\circ\text{C}$   
with only radiation cooling

# Devices for Slow Extraction

## 2) Beam Diffusers

# Beam diffuser for loss reduction

Top view

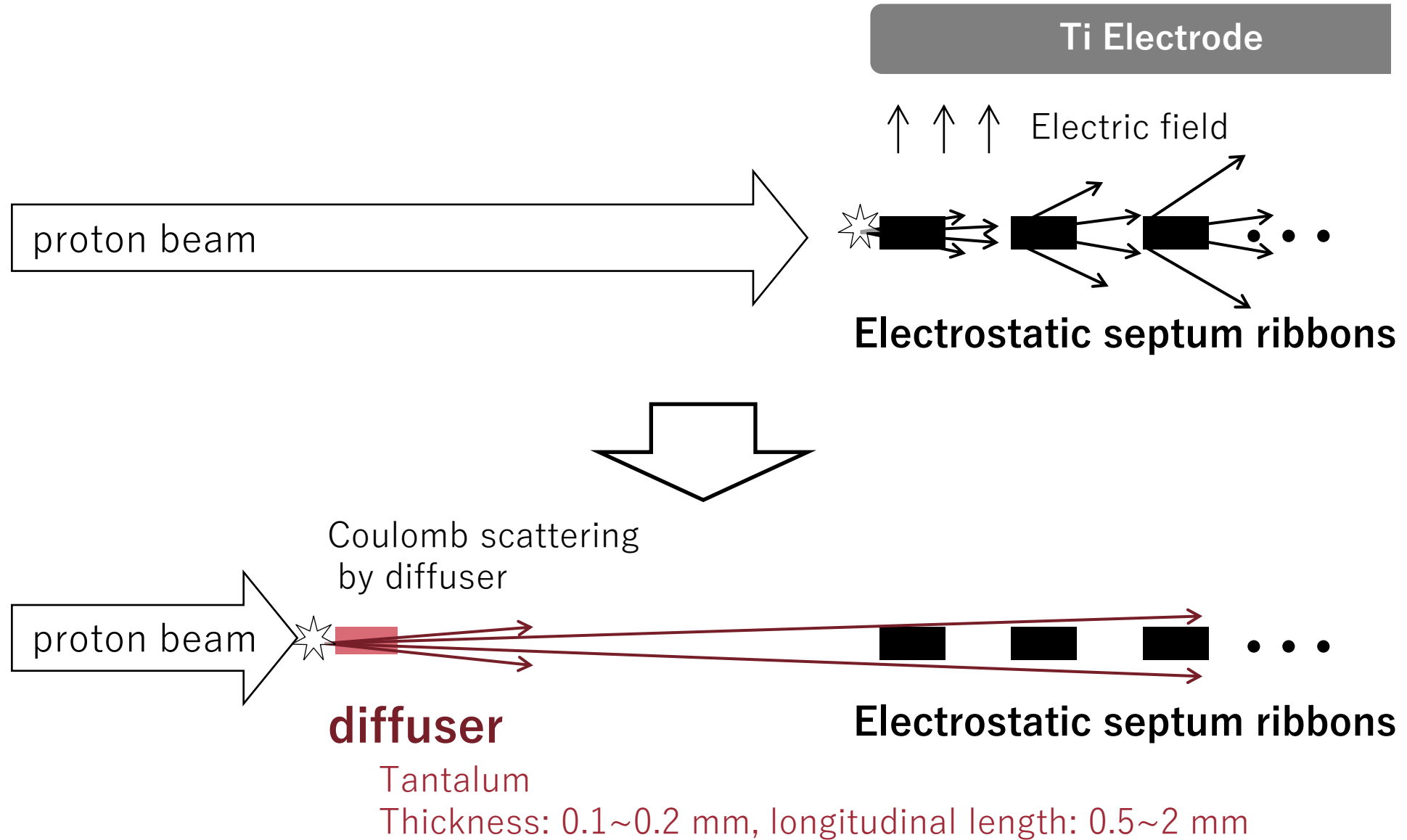

# Diffuser material

---

use multiple Coulomb scatterings to diffuse the angle distribution

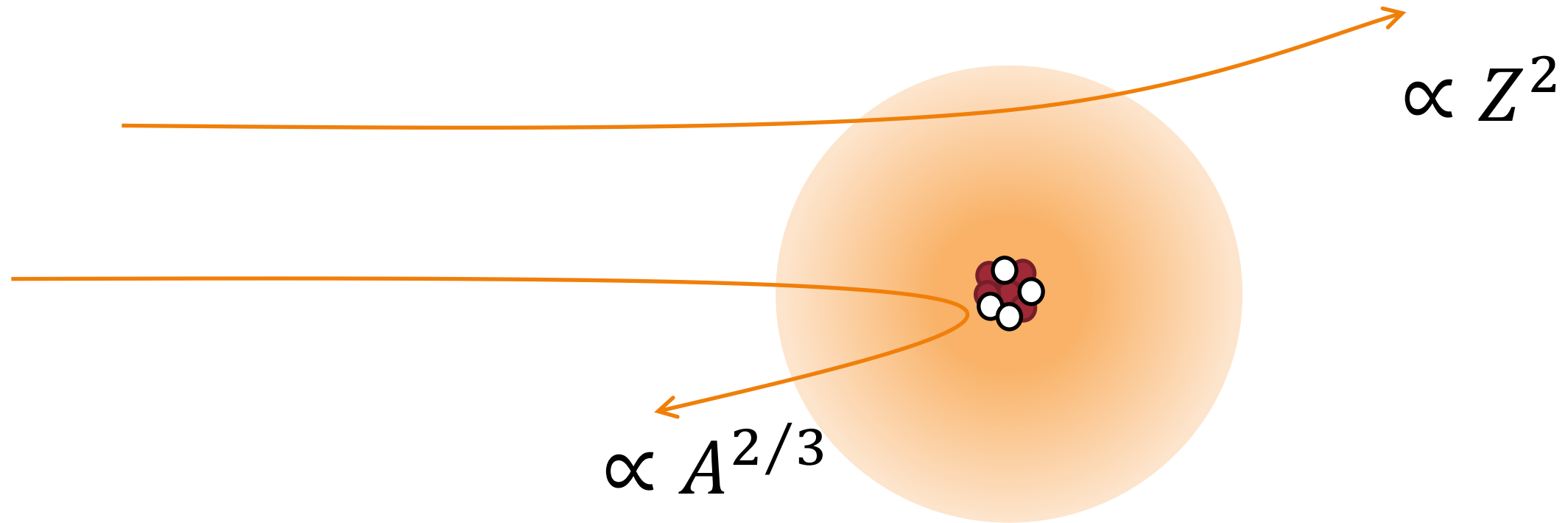

large angle nuclear collisions are harmful because it induces beam loss at the diffuser

With high-Z material, the length of the diffuser can be made short

→ Large-angle nuclear collisions can be suppressed

We chose tantalum ( $Z=73$ ,  $A=181$ ) for the diffuser material

# Places for Diffusers

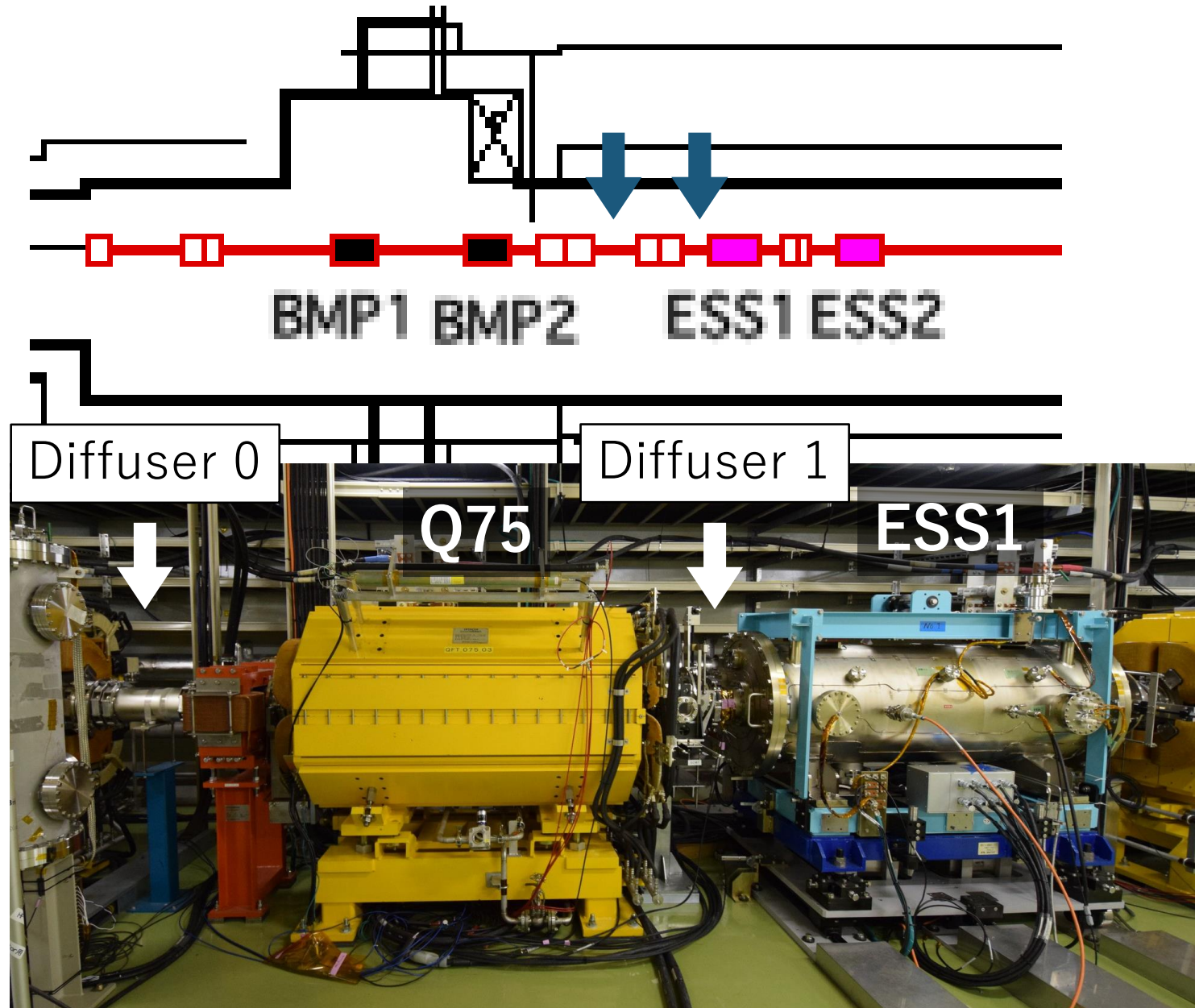

We searched for the optimal diffuser size for these two locations using FLUKA code.

# Optimized sizes of diffusers

	Diffuser 0 phase $\sim 5^\circ$		Diffuser 1 phase $\sim 0.7^\circ$		beam loss
	thickness [um]	length [mm]	thickness [um]	length [mm]	
No diffuser	-	-	-	-	1
diffuser 0 only	200	0.5	-	-	0.42
diffuser 1 only	-	-	100	2	0.47
diffuser 0 and 1	200	0.5	100	2	<b>0.35</b>

using FLUKA

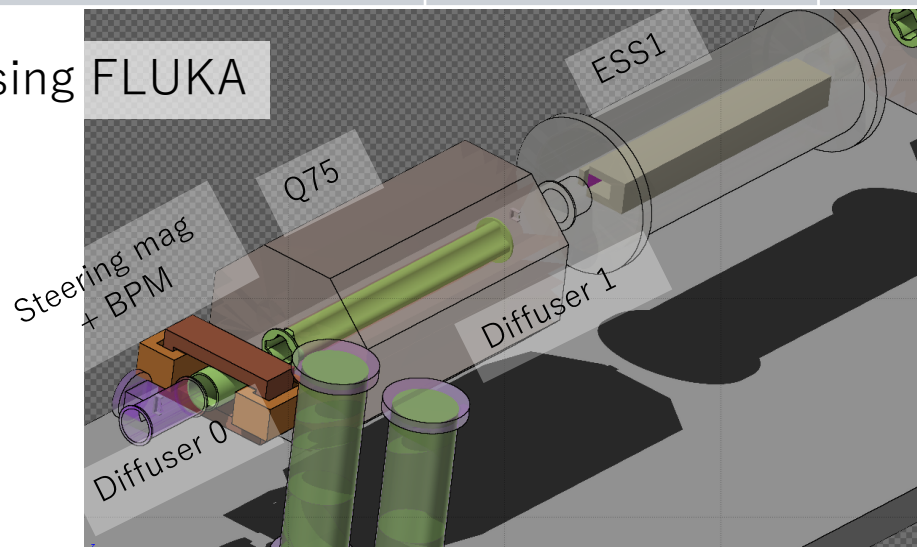

Diffuser at large phase advance  
can be shorter in longitudinal length  
but needs to be thicker



# Installed Beam Diffusers

**Diffuser 0**

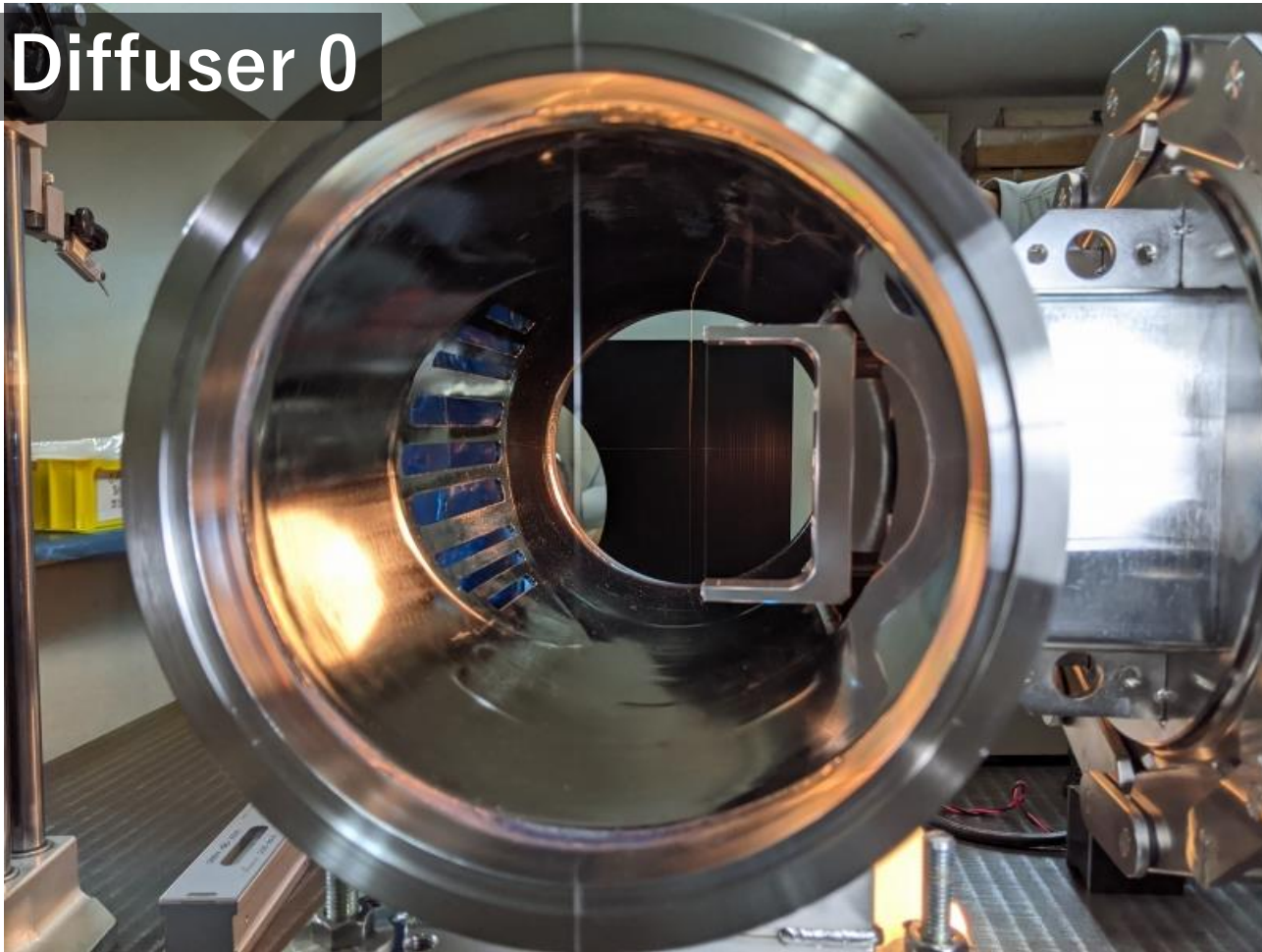

**Diffuser 1**

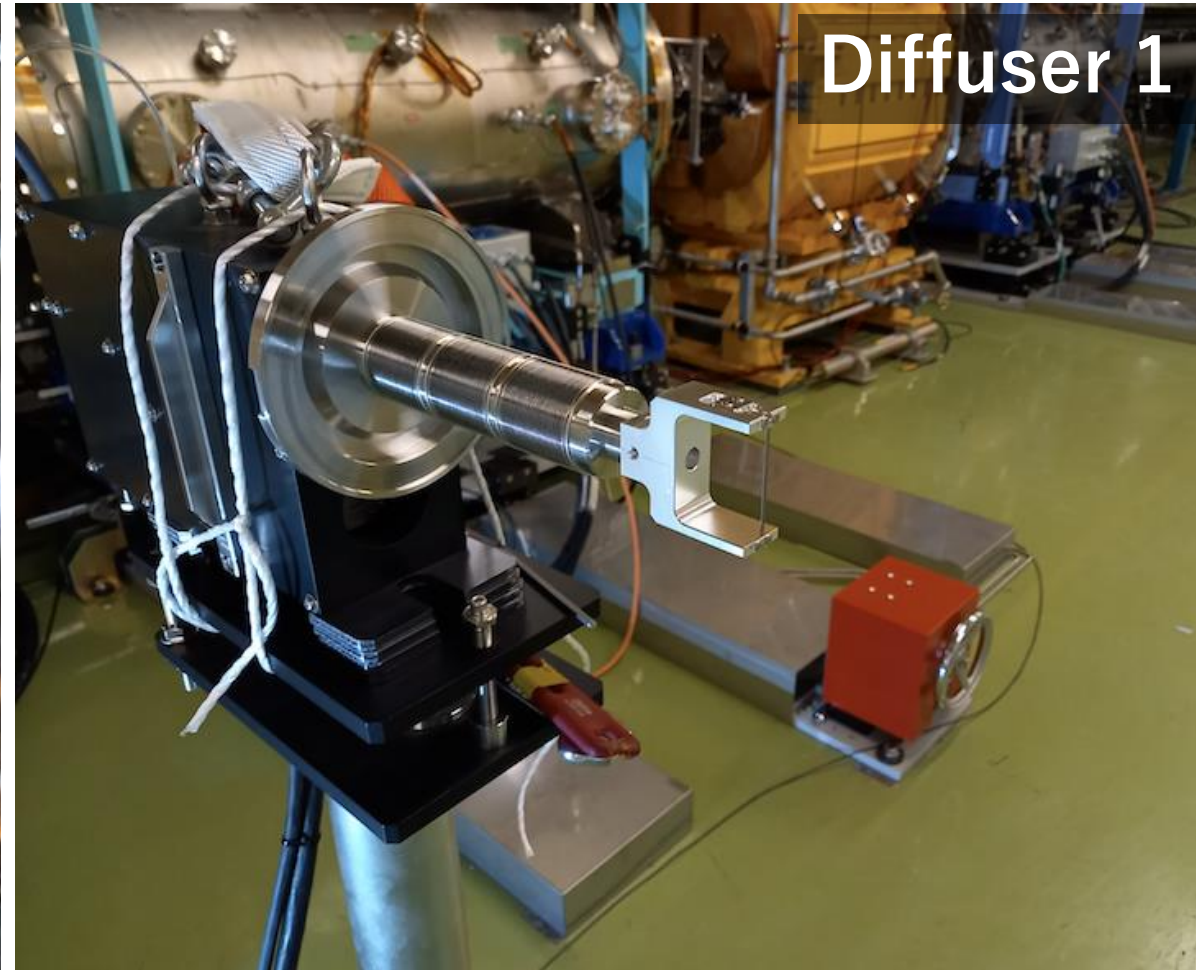
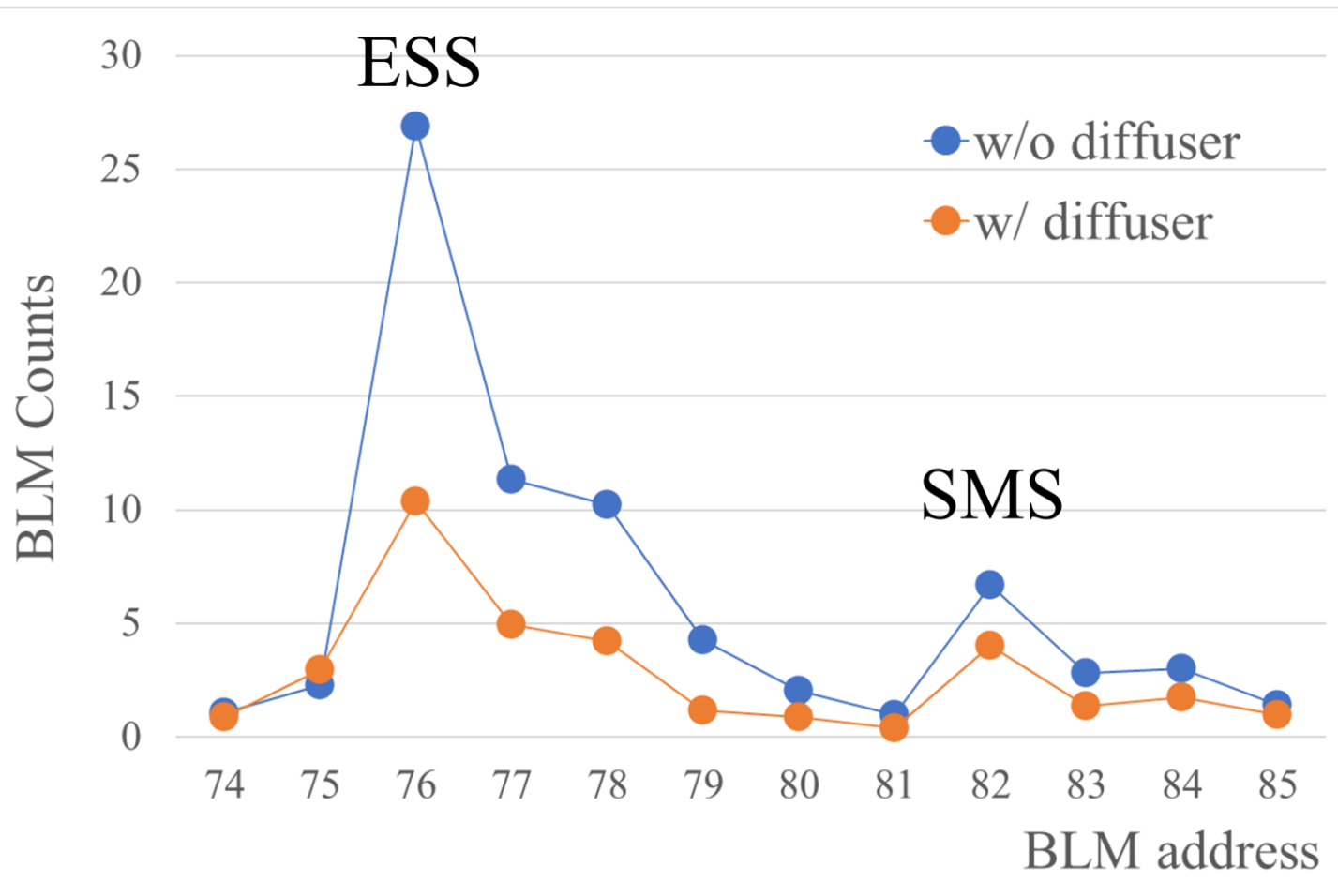

Photo from downstream

# Beam loss distribution with diffuser 0

2021-02-18 16:00-17:00

Beam power: 10 kW



**Beam loss was reduced to factor ~0.4 with diffuser 0 only (in good agreement with simulation)**

- Diffuser 1 test
- Test with high-power beam will be done in the next beamtime

# Devices for Slow Extraction

## 3) Collimator

# Residual Dose in the Upstream Part of the Straight Section

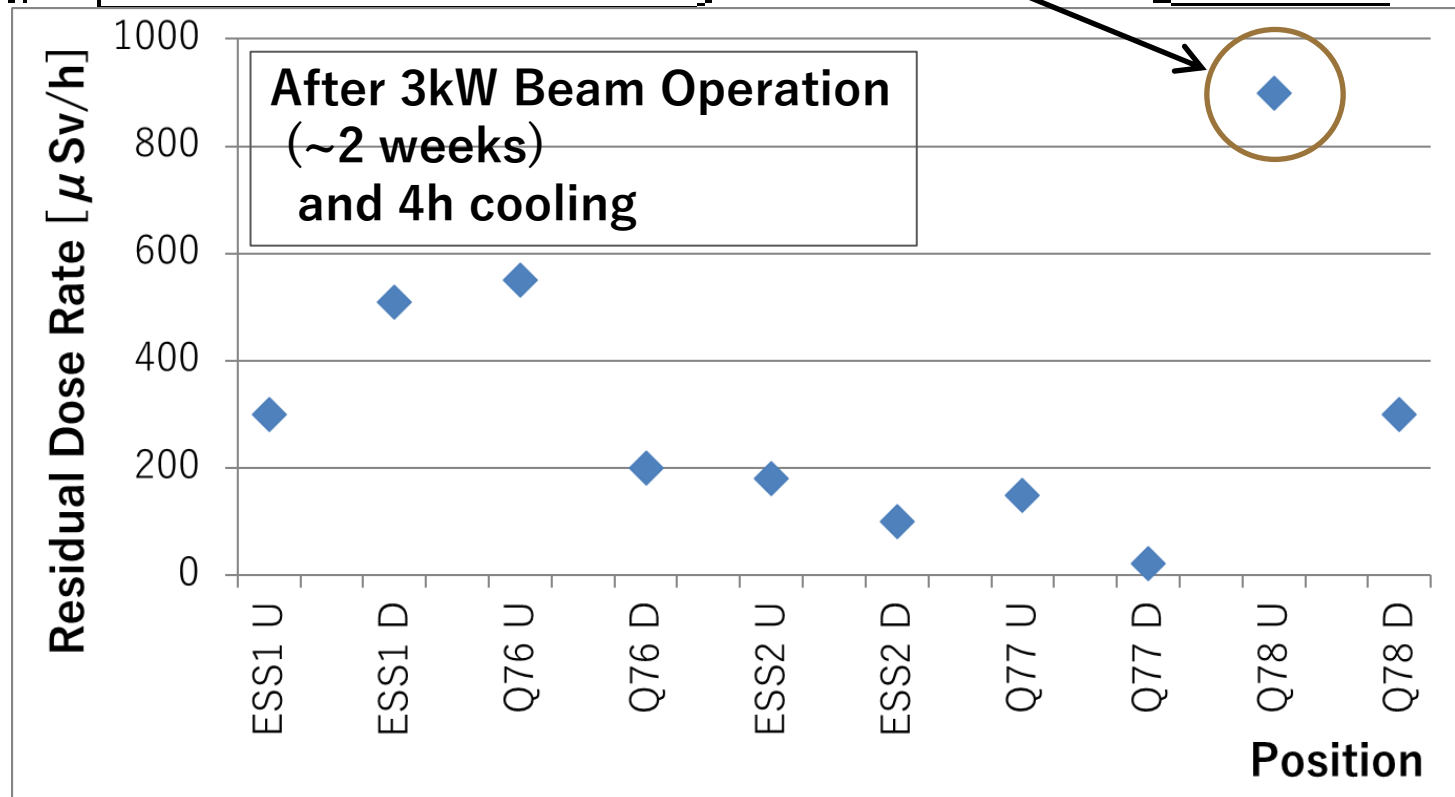
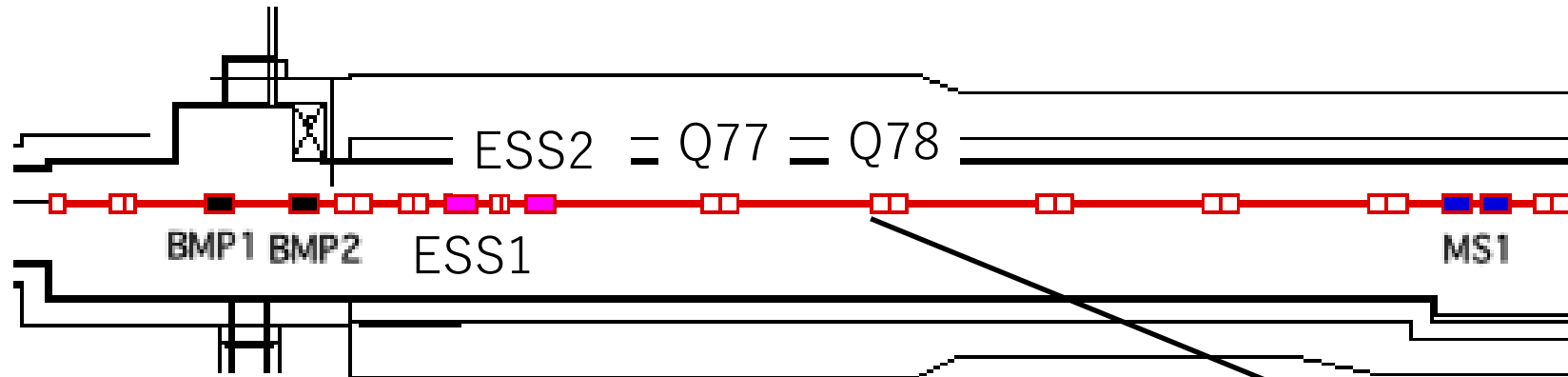

A steering magnet and a BPM are located just upstream of the Q78. They must be in a maintainable condition.

# Simulation for Collimator at the downstream of ESS

## Top View

Before COL installation

After COL installation

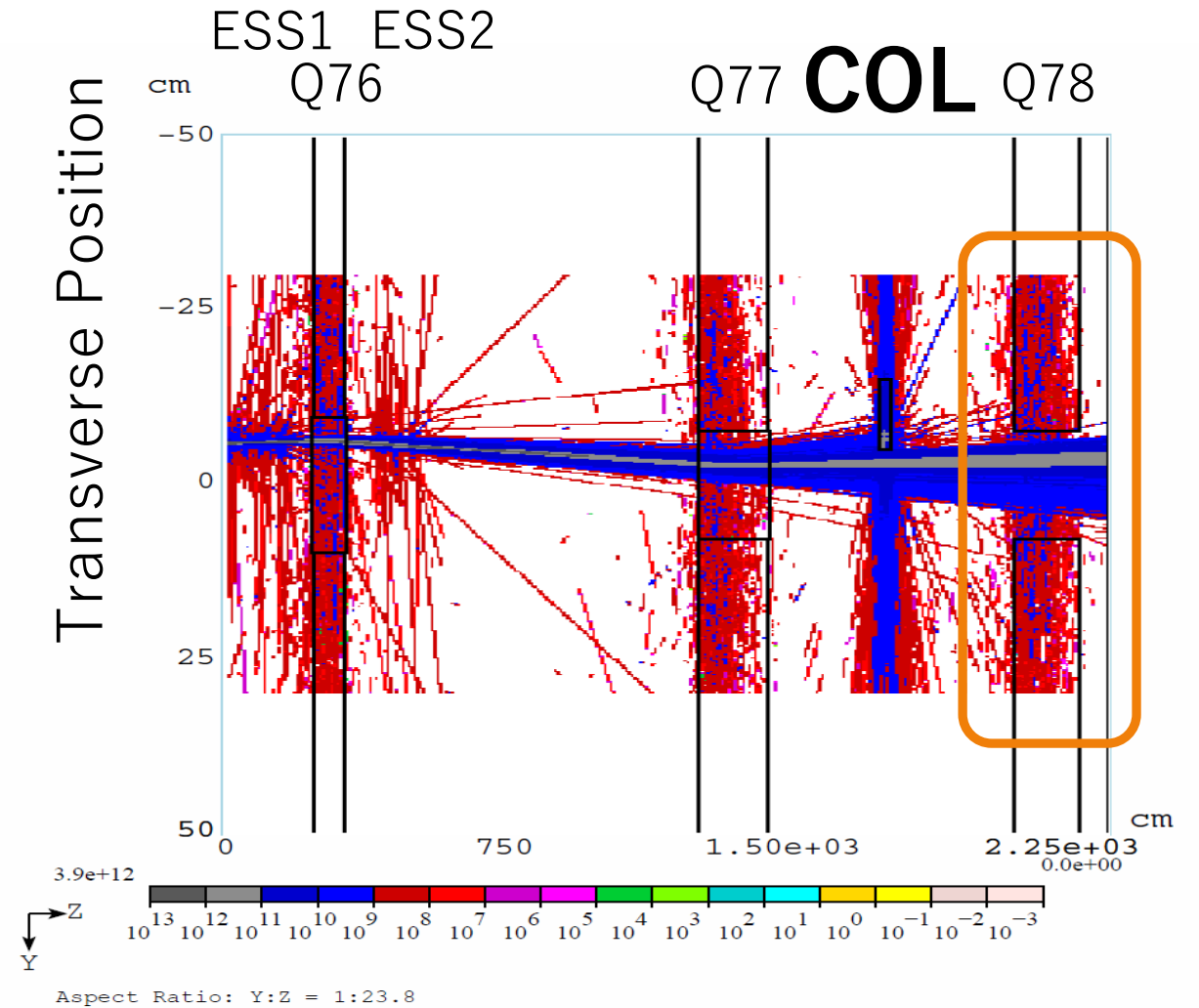
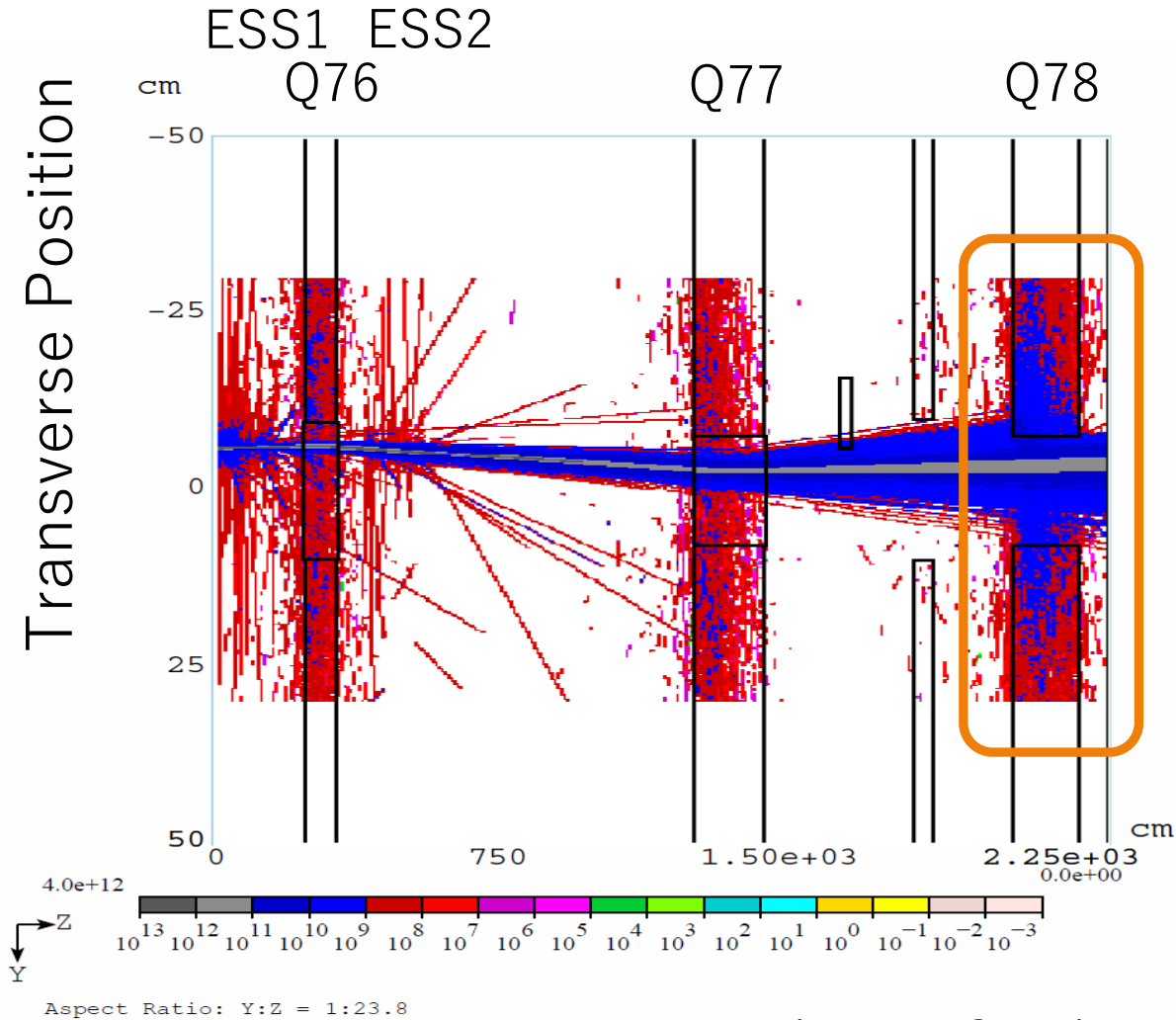

by MARS code

# Configuration of the Collimator

Hcol : 400 x 250 x t60 mm

Vcol : 400 x 120 x t60 mm x 2

Density: 18 g/cm<sup>3</sup>

Tungsten alloy  
(W95%-Cu3%-Ni2%)

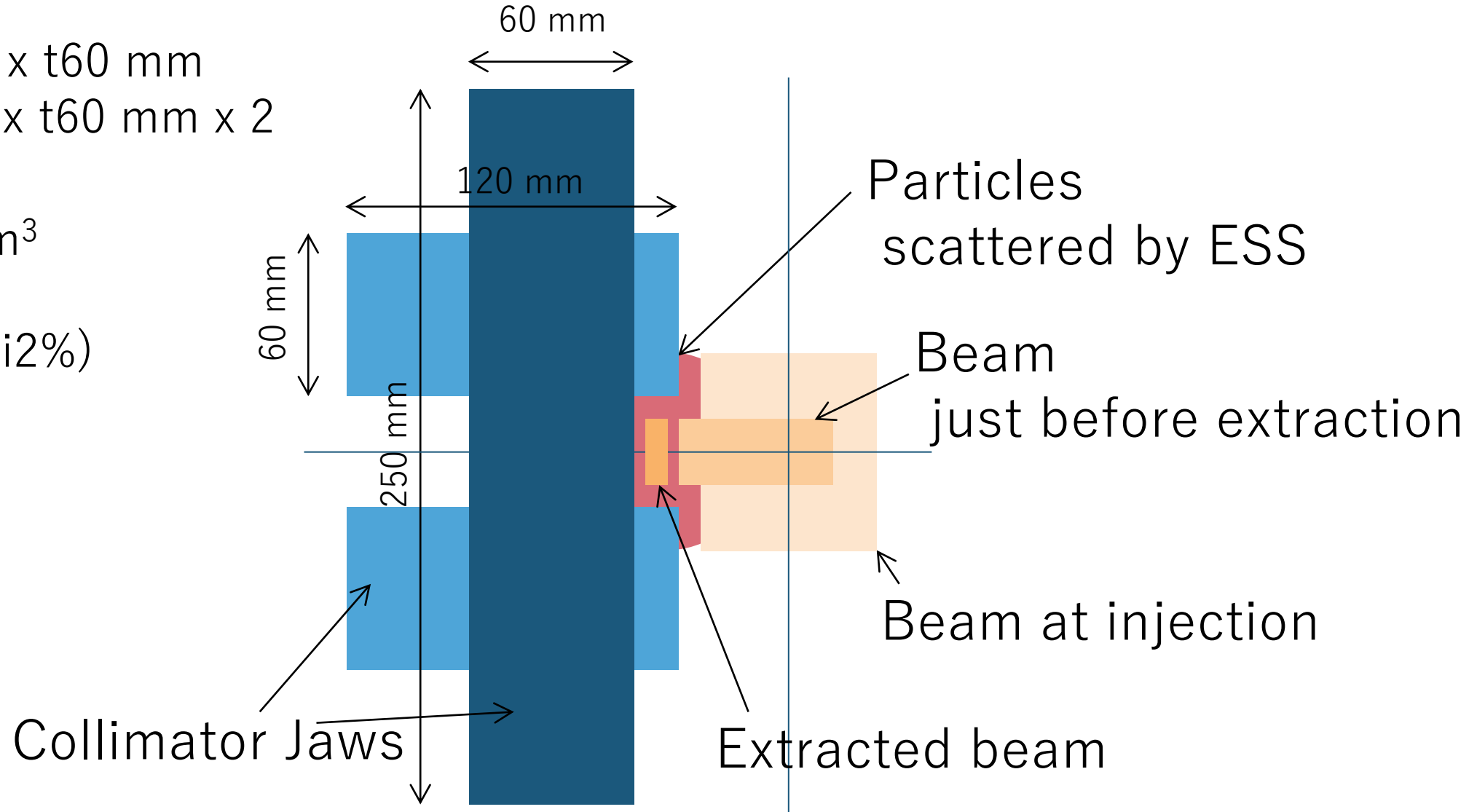



# Residual Dose before and after Collimator Installation

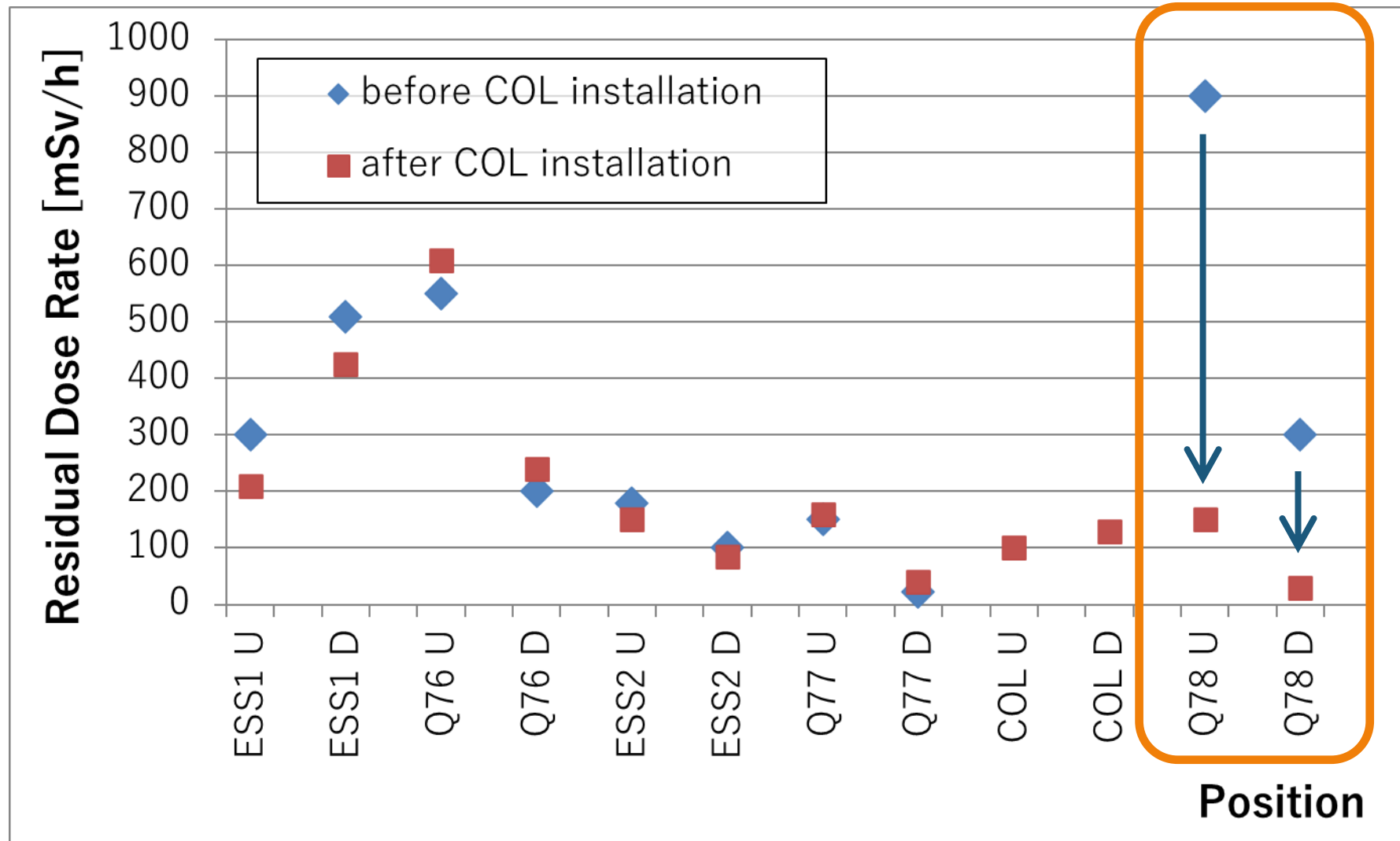



# Future Plans

# Bent Silicon Crystal

Beam loss may be further reduced by using bent silicon crystals instead of beam diffusers. At CERN SPS 400 GeV slow extraction the effectiveness of the bent silicon crystal has already been confirmed.

We are considering replacing diffuser 0 with bent silicon crystal in the future.

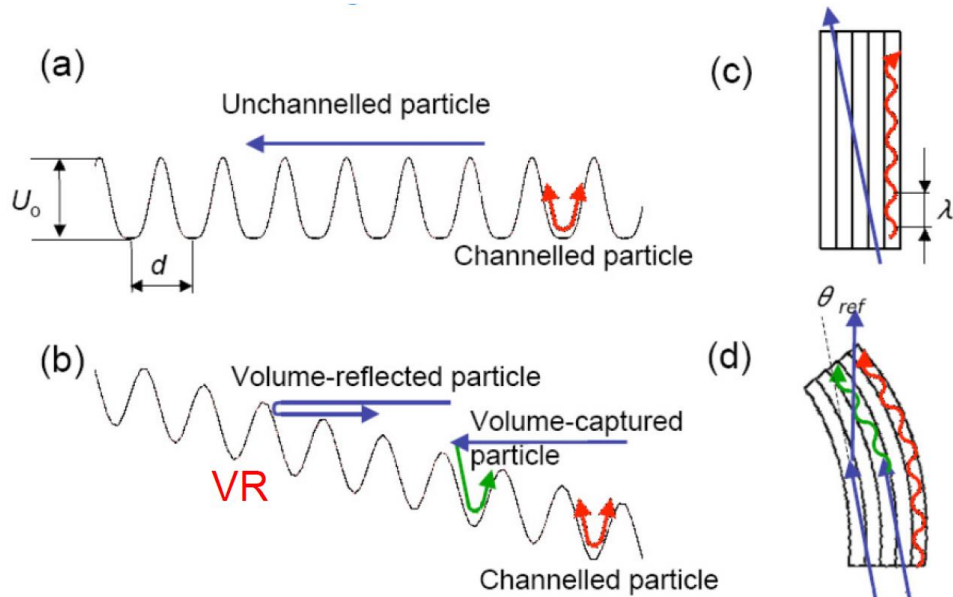

W. Scandale *et al.*,  
“Deflection of 400 GeV/c proton beam with bent silicon crystals at the CERN Super Proton Synchrotron”,  
PRAB 11, 063501 (2008)

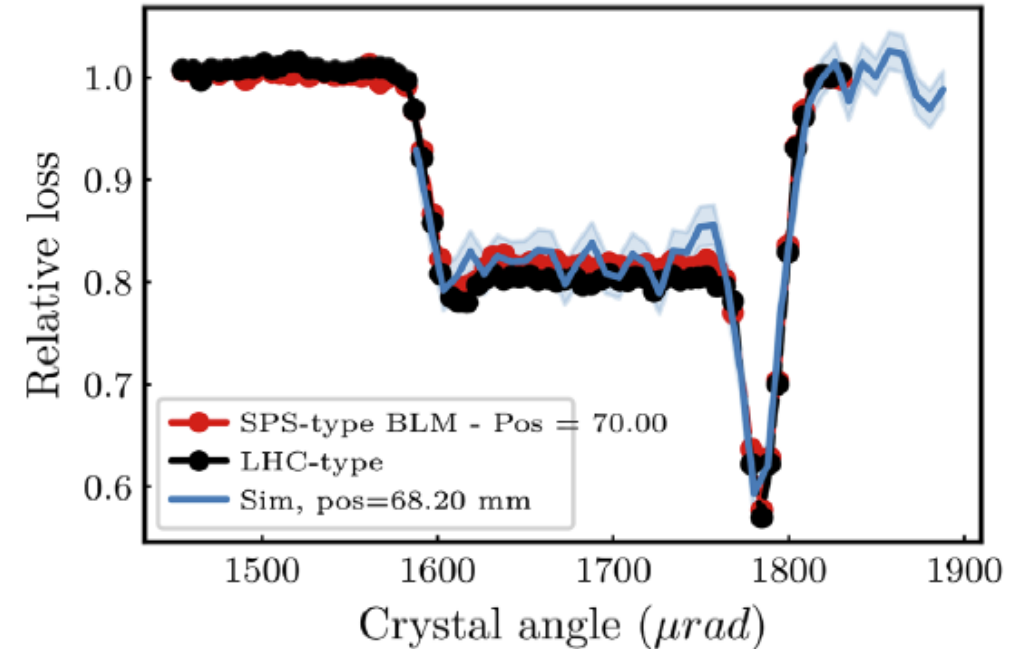

F. M. Velotti *et al.*,  
“Septum shadowing by means of a bent crystal to reduce slow extraction beam loss”,  
PRAB 22, 093502 (2019)

# Low-Z Material for Septum Electrode

---

If septum electrodes can be made from low-Z materials, beam loss can be significantly reduced.

Carbon nanotubes (CNT) wires were considered one of the candidates, but several negative results have already been reported.

J. Borburgh *et al.*, “Experimental Results of Low-Z Materials as a High Voltage Septum Anode”,  
29th International Symposium on Discharges and Electrical Insulation in Vacuum (ISDEIV), Padova, Italy, 2021, pp. 446-449.

We are now considering the possibility of using copper-coated CNT wire for the septum electrodes.

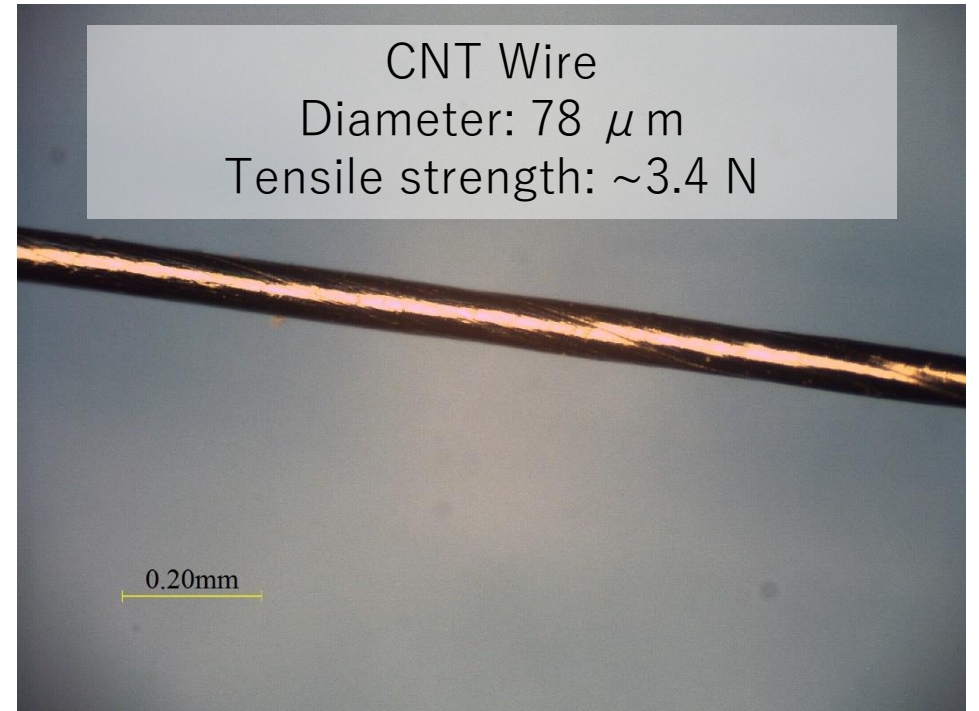

# Summary

---

Electrostatic septa with thin ribbon septum electrode were developed, and a high extraction efficiency of 99.5% with 64 kW beam power in slow extraction was achieved with the help of dynamic bump scheme.

We also installed a beam collimator to suppress the activation of equipment downstream of the electrostatic septum and confirmed the expected effect.

We plan to conduct a beam test of the beam diffusers for the beam loss reduction installed upstream of the ESS.

We are also considering replacing beam diffusers with bent silicon crystals to achieve further beam loss reduction.

We plan to start searching for low-Z materials which are suitable for septum electrodes.