

# The Radio Frequency Quadrupole

Maurizio Vretenar, CERN

Intermediate Accelerator Physics Course  
Chios 2011

1. Introduction - Why do we need RFQs
2. RFQ dynamics, vane modulations
3. RFQ resonators, 4-vane and 4-rod
4. RFQ construction, mechanical properties
5. Overview of RFQs

### Low energy →

for protons,  
between ~ 50 keV (source extraction) and ~ 3 MeV (limit for an effective use of the DTL)  
→ range  $\beta = 0.01 - 0.10$

### Why it is a problem?

1. (from previous lecture): need strong focusing (strong space charge!), but the short cell length ( $\sim \beta\lambda$ ) limits the length of quadrupoles, for ex.  $\beta\lambda(1\text{MeV}, 352\text{MHz}) = 3.9\text{cm}$
2. in this region the beam needs to be bunched → standard bunching systems are quite ineffective (~50% beam loss...).
3. At low energy, the usual accelerating structures have low efficiency (low shunt impedance).

### The classical solution:

1. Increase as much as possible the extraction voltage from the source → huge HV installations, up to the maximum of some 800 kV.
2. Add a bunching section (1 or 2 cavities) after the source extraction.
3. Start the first accelerating structure (usually a Drift Tube Linac) from the minimum possible energy.

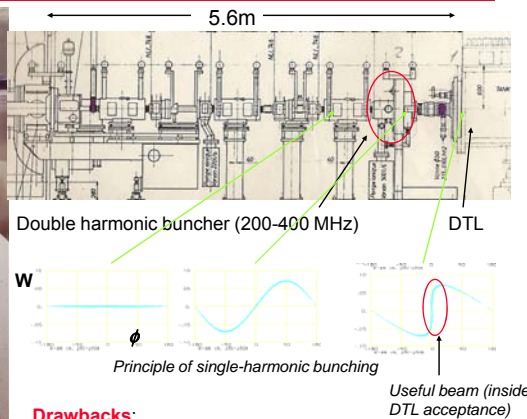
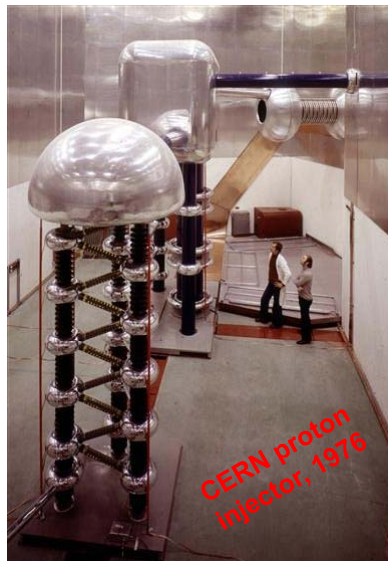
**Drawbacks:**

- Large and expensive HV column
- Reliability (800 kV...)
- Bunching efficiency (~50%)
- Long line with inefficient magnetic focusing ( $\propto \beta$ )
- Difficult DTL at low energy (short tubes and quads)<sub>3</sub>
- Large emittances for high currents

The driving force for the development of something new for the low-energy section was the research in URSS and USA on **high-current proton accelerators**. The idea is to break the limitation to current coming from **space charge in the beam transport** and from **bunching losses**.

- 1960's: Early works of I. Kapchinski at ITEP (Moscow): idea to use at low energy an **electric quadrupole focusing channel**, excited at RF frequency, and modulated to add a **longitudinal field component** providing **adiabatic bunching and acceleration**.
- 1969: an RF resonator is designed around Kapchinski's electrodes by V. Teplakov (IHEP). **First paper** on the RFQ by Kapchinski and Teplyakov (in Russian). First **experimental RFQ** in Russia (1974).
- 1977: the idea arrives at **Los Alamos** (USA), introduced by a Czech refugee.
- 1977-1980: the Los Alamos team is enthusiastic about this idea (for their Fusion Material Irradiation), makes some improvements to the original Kapchinski structure and develops a new resonator design. The **first complete RFQ** is built at Los Alamos and successfully operated (for a few hours...) in 1980.
- 1980's: the RFQ principle spreads around the world, more RFQs are built in the USA and in Europe (1<sup>st</sup> CERN RFQ: 1984). Long and difficult **learning curve** (RFQs are not simple devices...).
- 1985-1995 : **reliable RFQ designs** exist and progressively replace the old pre-injectors in most accelerator laboratories (CERN: 1993). Different design and applications are proposed all over the world.
- 1995-now : new RFQs are designed and built for extreme applications, like **very high intensity** <sub>4</sub> (CW, high current).

# RFQ compared to the old pre-injectors



The old pre-injector at CERN (1976):  
Source+  
Cockroft Walton  
+line+bunching

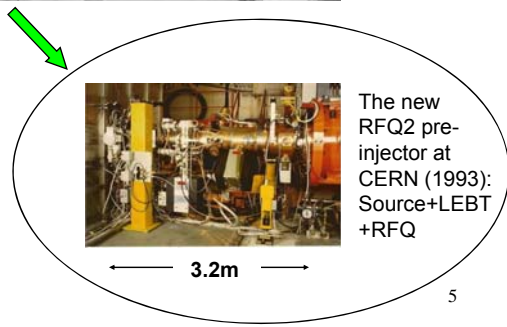

The new RFQ2 pre-injector at CERN (1993):  
Source+LEBT  
+RFQ

# The Radio Frequency Quadrupole (RFQ)



RFQ = Electric quadrupole focusing channel + bunching + acceleration

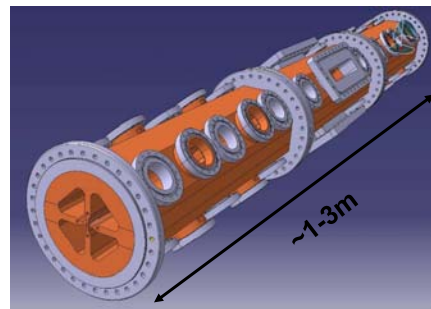
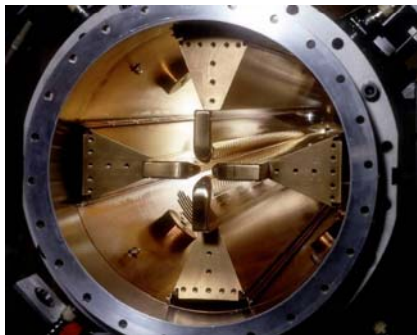

New and performing accelerator.  
Compact and critical structure, where beam dynamics, RF and mechanical aspects are closely interconnected.

# CAS The basic RFQ principle



- Four electrodes (called **vanes**) between which we excite an RF Quadrupole mode  
 → **Electric focusing channel**, alternating gradient with the period of the RF. Note that electric focusing does not depend on the velocity (ideal at low  $\beta$ !)
- The vanes have a **longitudinal modulation** with period =  $\beta\lambda$  → this creates a longitudinal component of the electric field. The modulation corresponds exactly to a series of RF gaps and can provide acceleration.

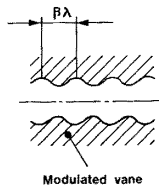
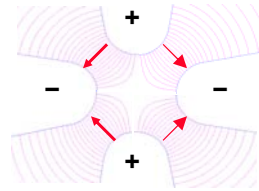

Modulated vane  
Opposite vanes (180°)

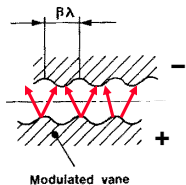

Modulated vane  
Adjacent vanes (90°)

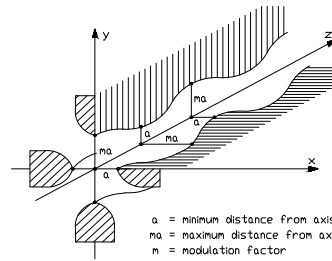

7

# CAS Peeping into the RFQ...



Looking from the RF port into the new CERN RFQ (Linac4, 2011)

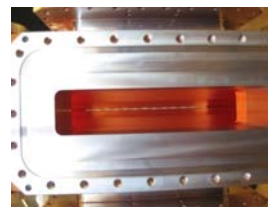

8

# CAS Bunching and acceleration



3. The modulation period (distance between maxima) can be slightly adjusted to change the phase of the beam inside the RFQ cells, and the amplitude of the modulation can be changed to change the accelerating gradient → we can start at  $-90^\circ$  phase (linac) with some bunching cells, progressively bunch the beam (adiabatic bunching channel), and only in the last cells switch on the acceleration.

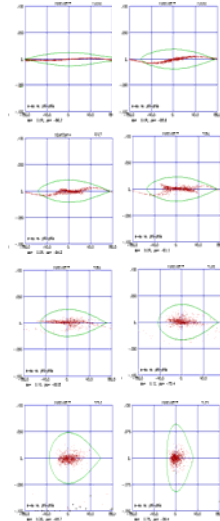

☞ An RFQ has 3 basic functions:

1. Adiabatically bunching of the beam.
2. Focusing, on electric quadrupole.
3. Accelerating.

Longitudinal beam profile of a proton beam along the CERN RFQ2: from a continuous beam to a bunched accelerated beam in 300 cells.

9

# CAS RFQ beam dynamics



An RFQ is made of a sequence of cells (length  $\beta\lambda \rightarrow$  in 1 m we can have  $> 100$  cells) where the beam dynamics designer can vary 3 parameters for each cell:

1. **Aperture**  $a$  (defines the focusing strength)
  2. **Modulation factor**  $m$  (defines the longitudinal component)
  3. The **beam phase**  $\phi$ , phase difference between bunch center and RF wave (defines the bunching and/or accelerating action).
- + 1 more parameter that is common to all cells (or can be changed with much less freedom): the **RF voltage**  $V$ .

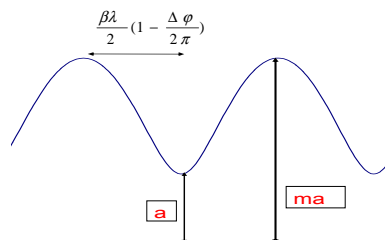

$a$  = minimum aperture  
 $m$  = modulation factor (ratio bw. max and min aperture)

cell length/ $\beta\lambda$  = changing the length of the cell with respect to the optimum length for a given beta will change the RF phase seen by the beam.

# CAS The Kapchinski potential



In order to define the 3-dimensional shape of the RFQ electrodes, Kapchinski introduced an analytical expression for the fields in an RFQ channel :

- The region between the vanes is small w.r.t. the wavelength → static approximation, we can use the formulae for static fields.
- The potential in the intervane region is then a solution of the Laplace equation, which in cylindrical coordinates can be solved by a series of Bessel functions.
- Kapchinski's idea: of all the terms in the series, take only the 2 that are interesting for us (*the transverse quadrupole term + a longitudinal focusing and accelerating term*) and try to **build some electrodes** that give only those 2 terms.

$$V(r, \vartheta, z) = A_0 r^2 \cos 2\theta + A_{10} I_0(kr) \cos kz \quad k=2\pi/\beta\lambda$$

Transverse quadrupole term

"Longitudinal" term

- an RFQ cell is defined by the 2 parameters,  $A_0$  and  $A_{10}$  (plus the phase)
- the 3 dimensional profile of an RFQ electrode must correspond to an equipotential surface of  $V(r, \theta, z)$

11

# CAS RFQ beam dynamics - 2



$$V(r, \vartheta, z) = A_0 r^2 \cos 2\theta + A_{10} I_0(kr) \cos kz \quad \rightarrow \text{The electrodes have to follow equipotential surfaces of this equation}$$

The equipotential surfaces giving the 2-term RFQ potential are **hyperbolic surfaces with a longitudinal sinusoidal modulation**.

→ The vanes in the 1<sup>st</sup> generation of RFQs were perfect truncated hyperbolae.

$V$ =voltage applied between 2 adjacent vanes

The constants  $A_0$ ,  $A_{10}$  depends on the geometry, and can be related to the modulation factors and to the intervane voltage  $V$ :

$$A_0 = \frac{V_0}{2a^2} \frac{I_0(ka) + I_0(kma)}{m^2 I_0(ka) + I_0(kma)} \quad A_{10} = \frac{V_0}{2} \frac{m^2 - 1}{m^2 I_0(ka) + I_0(kma)}$$

12

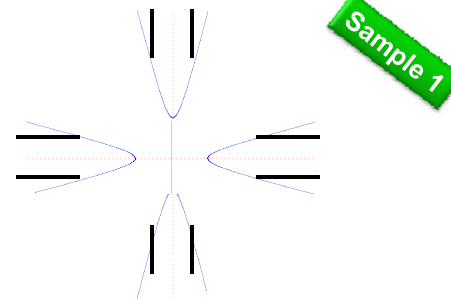

# CAS RFQ beam dynamics - 3



But:

1. Truncated hyperbolic surfaces are difficult to machine (require a precise 3D milling).
2. Modern field calculation codes allow to use vane profiles that cannot be analyzed analytically.

→ after the first generation of RFQs, the designers are now using simplified vane profiles with **constant curvature radius**.

→ introduction of **multipoles** (additional terms with respect to Kapchinski potential), can be calculated and their effect on the beam kept within acceptable limits.

Sample 2

# CAS Parameters of the RFQ



→ **Transverse focusing coefficient**

$$B = \left( \frac{q}{m_0} \right) \left( \frac{V}{a} \right) \left( \frac{1}{f^2} \right) \frac{1}{a} \left( \frac{I_o(ka) + I_o(mka)}{m^2 I_o(ka) + I_o(mka)} \right)$$

limited by sparking

Transverse field distortion due to modulation (=1 for un-modulated electrodes)

→ **Longitudinal bunching and accelerating field**

$$E_0 T = \frac{m^2 - 1}{m^2 I_o(ka) + I_o(mka)} \cdot V \frac{2}{\beta \cdot \lambda} \frac{\pi}{4}$$

Accelerating efficiency : fraction of the field deviated in the longitudinal direction (=0 for un-modulated electrodes)

cell length

Transverse focusing B is the external focusing contribution to phase advance (see linac lecture)

$$\sigma = \sqrt{\frac{B^2}{8\pi^2} - \frac{\pi q E_0 T \sin(\varphi) \lambda}{mc^2 \beta \gamma^3} - \frac{3Z_0 q I \lambda^3 (1-f(p))}{8\pi mc^2 \gamma^3 r^2 b}} \quad 14$$



The new CERN Linac4 RFQ:  
 352 MHz, 45 keV to 3 MeV, 303 cells, 3 m length, 70 mA beam current  
 Beam transmission 95 % (calculated)

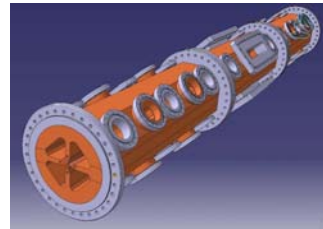
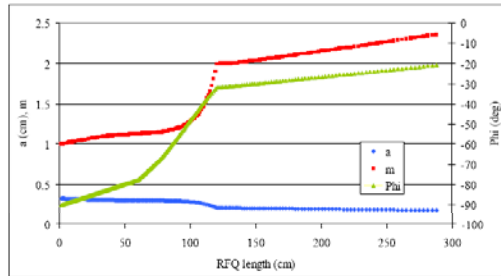

The first ~200 cells are used for adiabatic bunching of the beam: the synchronous phase is slowly increased from -90 to -20 deg → bunching with low beam loss!

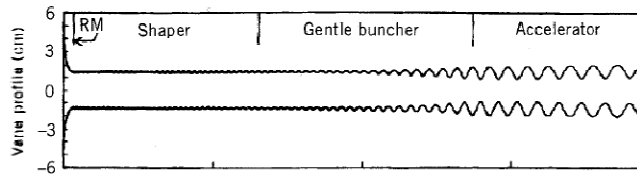

<b>Radial matching</b> to adapt the beam to a time-varying focusing system		
		aperture smoothly brought to the average value
<b>shaping</b> to give the beam a longitudinal structure		
Taper phase to -80,-60 deg	start modulation	aperture such that focusing is constant
<b>bunching</b> to bunch and begin acceleration		
Taper phase to -30,-20 deg	modulation to max	aperture such that focusing is constant
<b>acceleration</b> to bring the beam to the final energy.		
Constant phase	Constant modulation	Constant aperture
<b>output matching</b> to adapt the beam to the downstream user's need.		





**Problem:**

How to produce on the electrodes the quadrupole RF field?

2 main families of resonators: 4-vane and 4-rod structures

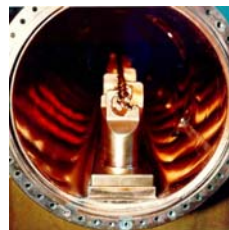
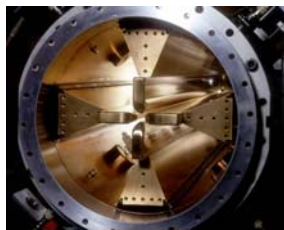

plus some more exotic options  
(split-ring, double-H, etc.)



**Remark:**

what is the ideal frequency for an RFQ?

Cell length  $\beta\lambda/2$  at injection should be mechanically achievable, of the order of few mm.

For heavy ions,  
 $\beta \sim 10^{-4} - 10^{-3}$   
corresponding to  
 $f \sim 10 - 100$  MHz

For protons,  
 $\beta \sim 10^{-2}$  makes higher frequencies possible, but beam dynamics (focusing  $\sim f^2$ ) and technology limit to  
 $f \sim 200 - 400$  MHz

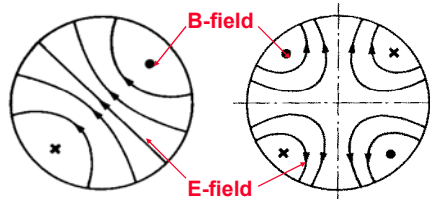

Empty cavity; mode TE<sub>11</sub>    Empty cavity; mode TE<sub>21</sub>

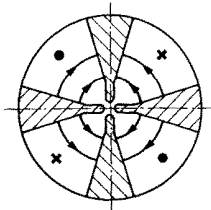

Cavity with vanes

Basic idea:

An empty cylindrical cavity can be excited on different modes.

Some of these modes have only transverse electric field (the TE modes), and in particular going up in frequency one can find a "quadrupole" mode, the TE<sub>210</sub>.

The introduction of 4 electrodes (the vanes) can then "load" the TE<sub>210</sub> mode, with 2 effects:

- Concentrate the electric field on the axis, increasing the efficiency.
- Lower the frequency of the TE<sub>210</sub> mode, separating it from the other modes of the cylinder.

Unfortunately, the dipole mode TE<sub>110</sub> is lowered as well, and remains as a perturbing mode in this type of RFQs.

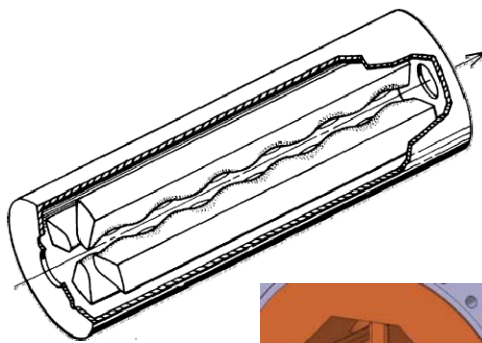

The RFQ will result in cylinder containing the 4 vanes, which are connected (large RF currents!) to the cylinder along their length.

Field excitation via a loop or an iris in one (or more) quadrants

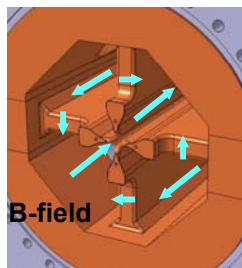

A critical feature of this type of RFQs are the end cells:

The magnetic field flowing longitudinally in the 4 "quadrants" has to close its path and pass from one quadrant to the next via some openings at the end of the vanes, tuned at the RFQ frequency!

# CAS Field symmetry and errors

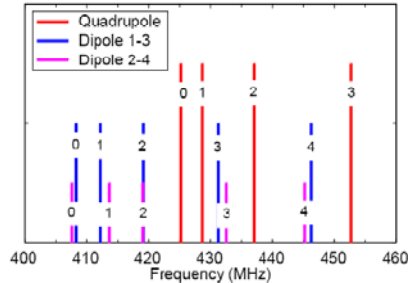

Mode spectrum (after tuning) of a 425 MHz, 2.75m long RFQ ( $3.9 \lambda$ ) – a limit case!

Why RFQs are so demanding in terms of tolerances?

☞ Beam dynamics wants a **pure quadrupole mode** (no dipole components, flat voltage along the RFQ).

☞ But the TE<sub>210</sub> quadrupole mode is not the only one: at frequencies close to the TE<sub>210</sub> operating one there are all modes of the TE<sub>21</sub> band (quadrupoles) and of the TE<sub>11</sub> band (dipoles).

☞ **Errors in the RFQ geometry** (deviations from quadrupole symmetry) will induce **errors in the electric field** (dipole components, longitudinal errors) inversely proportional to the frequency separation between operating and perturbing modes.

In order to keep the **e.m. field error <~1%** as required by beam dynamics are needed:

- Careful **design** and in some cases **stabilising** schemes (to keep perturbing modes far from operating mode).
- Correction schemes** to flatten the voltage (local tuners, end cells, etc.).
- Tight mechanical tolerances** in vane position (Linac4 RFQ: errors < 30  $\mu\text{m}$ ).

21

# CAS Measuring the RFQ field

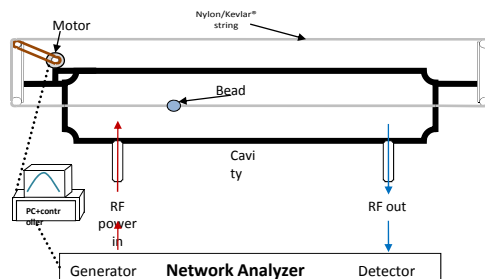

In RFQs, “bead-pull” RF measurements are very important.

A small metallic bead is slowly moved inside the 4 quadrants.

The variation in resonant frequency is proportional to the square of the e.m. field at the position of the bead.

An easy way to check the mechanical error and to dimension the correction schemes.

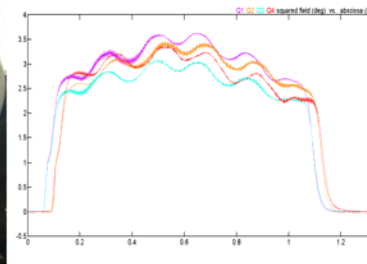

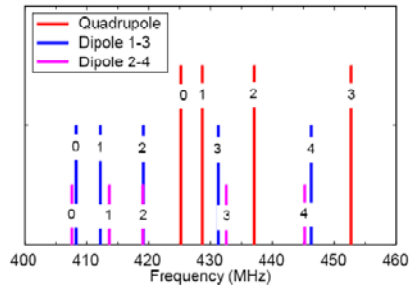

Mode spectrum (after tuning) of a 425 MHz, 2.75m long RFQ ( $3.9 \lambda$ )

In particular, the length of an RFQ is limited by field errors:

The difference in frequency between the higher order modes ( $n \geq 1$ ) and the modes at  $n=0$  is inversely proportional to  $(\text{length}/\lambda)^2 \rightarrow$  the longer the RFQ, the closer the higher-order modes come to the operating mode and the more difficult becomes to keep the field flat.

- Rule of thumb:
- length  $< 2\lambda \rightarrow$  no problem
  - $2\lambda < \text{length} < 4\lambda \rightarrow$  need particular care
  - length  $> \sim 4\lambda \rightarrow$  require segmentation and resonant coupling

to have shorter RFQs, choose the minimum injection energy allowed by space charge !  
(counterintuitive...)

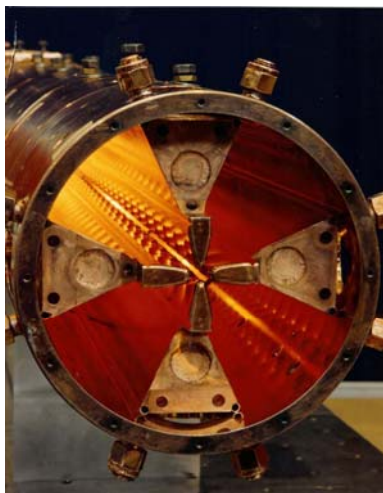

Proof of Principle (POP) RFQ, Los Alamos 1980 – the 1<sup>st</sup> vane-type RFQ  
100 KeV - 650 KeV, 30 mA , 425 MHz



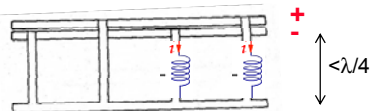
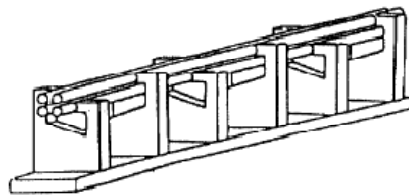
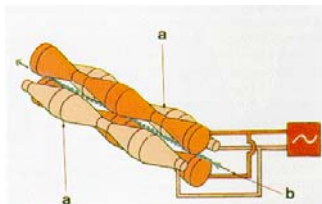

An alternative solution is to machine the modulation not on the tip of an electrode, but on a set of rods (machining on a lathe, old design) or on some small “vanelets”.

The 4 electrodes are then brought to the correct quadrupole potential by an arrangement of quarter-wavelength transmission lines. The set-up is then inserted into a cylindrical tank.

Cost-effective solution, becomes critical at high frequencies → dimensions become small and current densities go up.

Power densities are higher than in the 4-vane → problematic for high power applications.

**Commonly used for heavy ions at low frequency – low duty cycle ( $f < 200$  MHz).**

The electrodes can also be “vane-like” in structures using doubled  $\lambda/4$  parallel plate lines to create the correct fields.

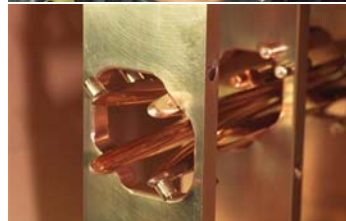
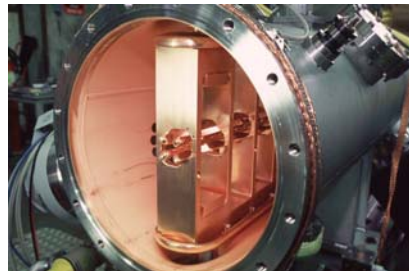

Two main mechanical problems:

1. The need to achieve the **tight tolerances** in vane machining and positioning required by beam dynamics and RF.



Machining of a vane for the new CERN RFQ (linac4)

RF and beam dynamics both require **tight tolerances** in the position of the electrodes (Linac4 RFQ:  $<30 \mu\text{m}$ ).

RF: presence of dipole and/or longitudinal components.

Beam dynamics: introduction of multipoles (Linac4 RFQ average aperture  $r_0 = 3.3 \text{ mm}$ , 1% of aperture is  $\sim 30 \mu\text{m}$ ). Minimum aperture  $a = 1.8 \text{ mm} !!$

Linac4 RFQ Mechanical Tolerances	Value	Units
Machining error	$\pm 20$	$\mu\text{m}$
Vane modulation error	$\pm 20$	$\mu\text{m}$
Vane tilt over 1 m	$\pm 100$	$\mu\text{m}$
Vane positioning error (displacement h+V)	$\pm 30$	$\mu\text{m}$
Vane thickness error	$\pm 10$	$\mu\text{m}$
Electrode gap (contiguous modules)	$100 \pm 15$	$\mu\text{m}$
Section tilt over 1 m	$\pm 30$	$\mu\text{m}$
Electromagnetic field error	$\pm 1$	%

2. The need to assemble a LEGO® of **several components** (tanks, vanes or rods, supports, etc.) that have to fit together keeping the **tolerances** and providing a **good quality RF contact** (large currents flowing!).

4-vane, high frequency: **furnace brazing** of 4 copper elements

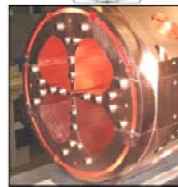
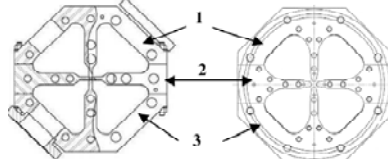

TRASCO, LNL, Italy

IPHI, CEA-CNRS, France

4-vane, low frequency: **EB welding or bolting** of copper or copper plated elements

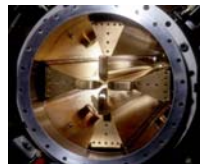

RFQ1 and RFQ2, CERN

SPIRAL2, CEA-CNRS, France



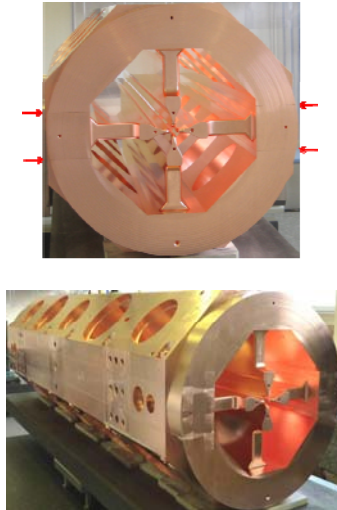

Linac4 RFQ:

- ☞ 3 segments of 1 m, each formed by 4 parts brazed together
- ☞ Required error in vane positions <math><30 \mu\text{m}</math>
- ☞ Achieved by a) precise machining of the contact surfaces and b) appropriate thermal treatments to minimize vane deformation during brazing.

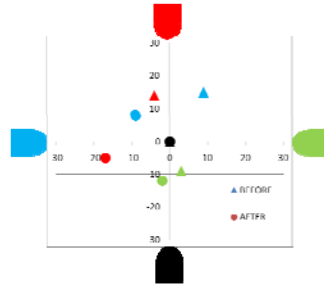

Errors before and after brazing <math><25 \mu\text{m}</math>

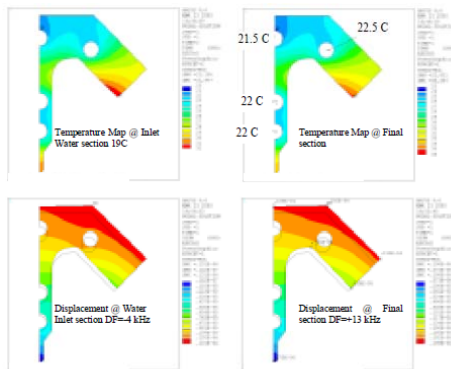

Fig. 6: Top: temperature maps at begin (left) and at the end (right) of one RFQ section. Bottom: deformation maps and frequency shifts.

Example: thermal study of the TRASCO RFQ (CW, 352 MHz, 1 kW/cm) – courtesy of LNL, Legnaro

1. High (beam) power RFQs need to dissipate large amounts of RF power in small volumes (vanes are “thin” to maximize shunt impedance).
2. Thermal deformations can lead to large voltage variations and to beam loss.



Need to carefully design and dimension the cooling channels to keep High (beam) power RFQs need to dissipate large amounts of RF power in small volumes (vanes are “thin” to maximize shunt impedance).

1. Thermal deformations can lead to large voltage variations and to beam loss.



“Star Wars” RFQ (now de-classified), 1983, LANL  
 2 MeV, 100 mA, ~5% duty, H-minus, 425 MHz  
 Cu plated carbon steel vanes and cavity, manifold coupled  
 Demonstrated very small emittance H-minus beams

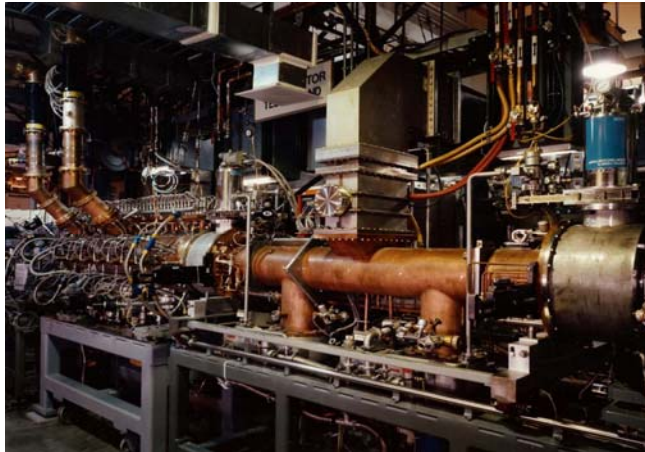

31



“BEAR” RFQ (beam experiment aboard a rocket)(partly classified) 1989  
 30 KeV – 1 MeV, 20 mA, <1% duty H-minus  
 425 MHz, solid-state RF system  
 Cu plated Al quadrants, joined by electroforming, 55 kg  
 Operated in sub-orbital flight with a “neutral” beam, LANL

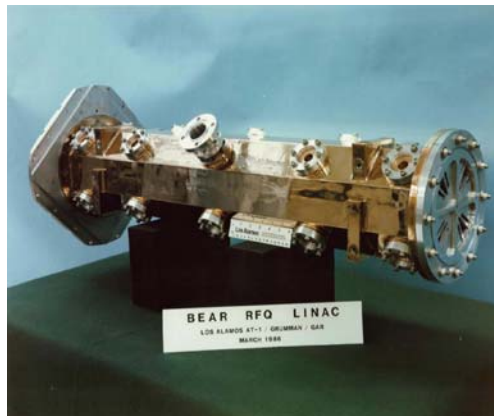





**The first high-beam-power RFQ**

LEDA RFQ (low energy demonstration accelerator)  
1999 - 2000  
75 keV-6.7 MeV, 100 mA cw protons  
350 MHz  
Brazed OFE Cu quadrants  
Resonantly coupled, 8 m long, LANL

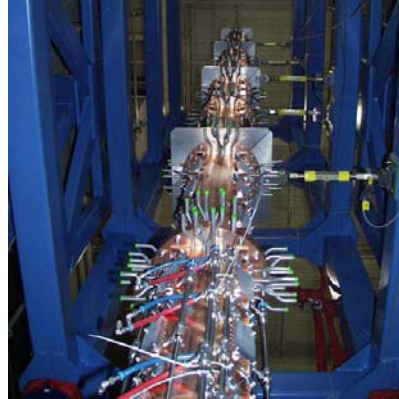

3



High frequency (352 MHz), high duty cycle (CW)  
for ADS studies and other applications.

2 RFQs in construction in Europe:

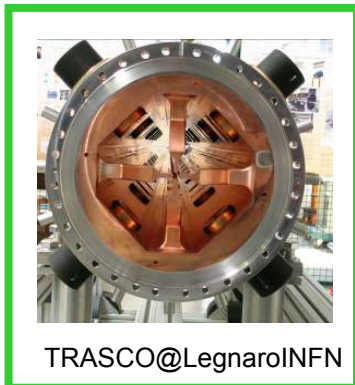
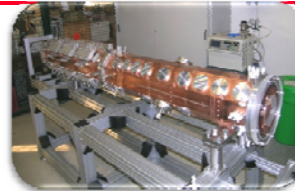

TRASCO@LegnaroINFN



IPHI@Saclay.CEA

34

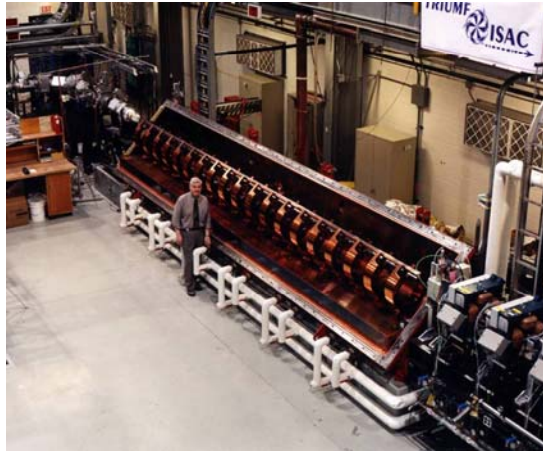

Low frequency (35 MHz), high duty cycle (CW) for post-acceleration of radioactive ions.

The ISAC-II RFQ at TRIUMF (Canada)



*Al prototype and the final installation of the superconducting RFQ at LNL, Italy*



**Superconducting RFQs:**

Only 2 Superconducting RFQs built so far in the world (Argonne, USA and Legnaro, Italy).

The modulation is extremely difficult to realise in Nb → a superconducting RFQ is limited to few cells at low frequency → heavy ions.

LNL superconducting RFQ: 2 separate structures, 1.4 m and 0.8 m, 41 and 13 cells

On proton RFQs with high intensity, the unavoidable beam loss during the bunching process would be very dangerous for a superconducting structure.



Medium frequency (176 MHz), high duty cycle (CW), 4-rod design for high-intensity deuteron and proton acceleration.

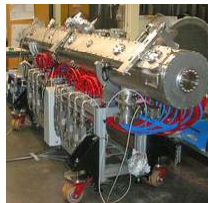

The SARAF RFQ, built by NTG and A. Schempp (IAP Frankfurt) for the Soreq Nuclear Research Center in Israel.



The CERN Linac4 RFQ  
 In construction at the CERN Workshop  
 First beam expected end 2011  
 45 keV – 3 MeV, 3 m  
 80 mA H-, max. 10% duty cycle

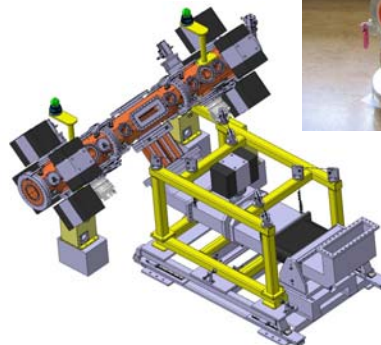

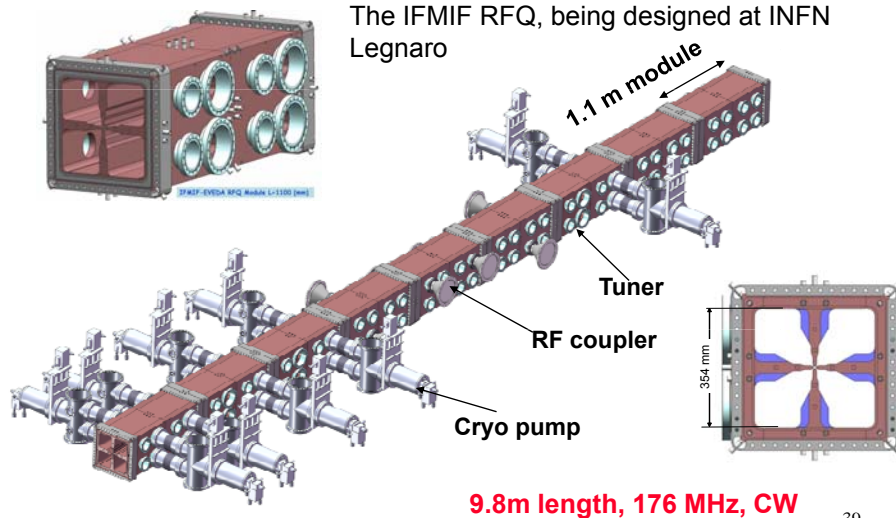

39



- ◆ T.P.WANGLER, "Space charge limits in linear accelerator", LA-8388 (Los Alamos)
- ◆ R.H.STOKES and T.P.WANGLER, "Radio Frequency Quadrupole and their applications", Annual Review of Nuclear and Particle Science, 1989
- ◆ K.R. CRANDALL, R.H.STOKES and T.P.WANGLER, "RF Quadrupole Beam dynamics Design study", 1979 Linear Accelerator Conference
- ◆ M.WEISS, "Radio Frequency Quadrupole", CERN-PS/87-51 (CAS Aarhus, 1986)
- ◆ M. PUGLISI, "Radio Frequency Quadrupole", CERN 87-03 (CAS Oxford, 1985)
- ◆ RFQ chapter in Wangler, RF Linear Accelerators

+ many thanks to A.M. Lombardi, C. Rossi, A. Pisent, J. Stovall, A. France for their help in preparing this lecture.

40