



# NIMMS-SEEIIST DESIGN

ELENA BENEDETTO, SEEIIST ASSOCIATION

MARIUSZ SAPINSKI, PSI

Specialised Course on Heavy Ion Therapy Research  
4-8 July 22 - online



This project has received funding from the European Union's Horizon 2020 research and innovation programme under grant agreement No 101008548

# SEEIIST - South East Europe International Institute for Sustainable Technologies

Consortium of 10 countries, to build a facility for **Cancer Research & Therapy** in South East Europe.

- **2017** Initiated by H. Schopper, former DG of CERN, and S. Damjanovic, physicist and (ex) Minister of Science of Montenegro.
- **2018** Yellow Book, by U. Amaldi et al.
- **2019** Accelerator design studies started, supported by EU, within a team based at CERN.
- **2021** Start of *HITRIplus*, SEEIIST is now integrated in a wider collaboration, studies continue in tight collaboration with the CERN-NIMMS initiative



✓ Science for peace  
✓ Scientific excellence  
✓ Education & Training  
✓ Green infrastructure





**CERN Next Ion Medical Machine Study (NIMMS)** leverages on CERN expertise to develop a **portfolio of technologies (...a “toolbox”)** for a new generation of medical accelerators with ions.

PIMMS in 2000 gave birth to CNAO/MedAustron  
NIMMS launched as a Knowledge Transfer initiative in 2019.

Open to collaborations internal and worldwide:

**SEEIIST**, TERA Foundation, GSI, INFN, Imperial College, U. Manchester, Cockcroft Institute, U. Melbourne, CIEMAT, CNAO, MedAustron, Riga University, DKFZ, U.Thessaloniki,...

Support from EU programs: HITRIplus and iFAST.

Input from medical/scientific community via **ENLIGHT** and the **International Biophysics Collaboration**.



HF Linac

Synchrotron

Gantry

Magnets

AI/ML\*

R-isotopes\*

\* in preparation

# SEEIIST advanced accelerator facility



- Research & therapy with ions:
  - p, He, C, O,...to Ar
  - Carbon ions up to 430 MeV/u
- Intensity x20(\*) European facilities
- Flexible dose-delivery modalities
  - Multi-Energy slow-resonant extraction
  - FLASH (high dose in less than <1s)
- Baseline layout is a PIMMS synchrotron (like CNAO/MedAustron)
- Option of a compact superconducting-magnet synchrotron

(\*)To deliver 2 Gy to 1 liter in one cycle

	p	He	C
Intensity	2.6 e11	8.2 e10	2.0 e10
Injection Energy (MeV/u)	7-10	5	5
Extract Energy (MeV/u)	60-250	60-250	100-430
Beam rigidity max (Tm)	2.42	4.85	6.62
Synchrotron diameter (m)		~25m	
Spill duration (s)		0.1 - 60	
Spill ripple @1 kHz ( $I_{max}/I_{ave}$ )		<1.5	





# OUTLINE

We will guide you through the components of the technical area of a medical synchrotron facility, discussing the specificities of SEEIIST:

- Intro about accelerators (MS)
- Ion sources (MS)
- Linac injector (MS)
- Synchrotron (EB)
- Gantry (EB)
- High-Energy Beam Lines and layout (MS)

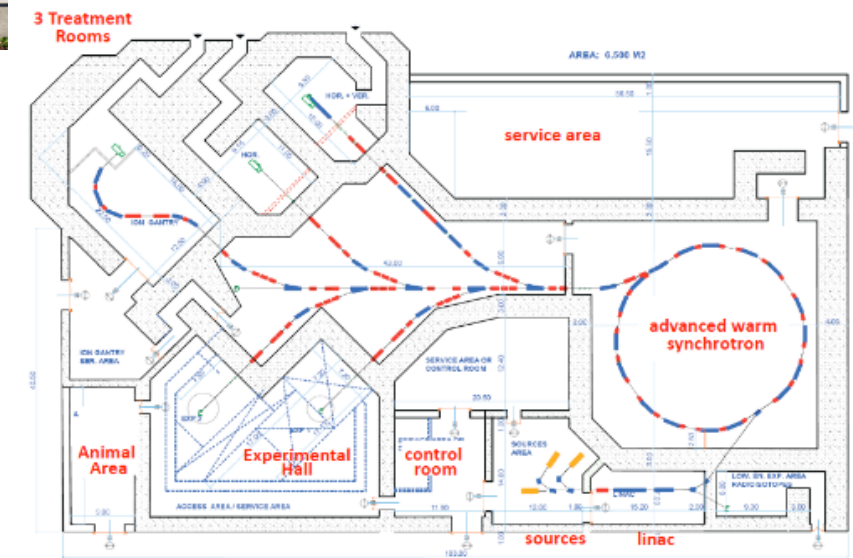

# RF accelerators – why RF?

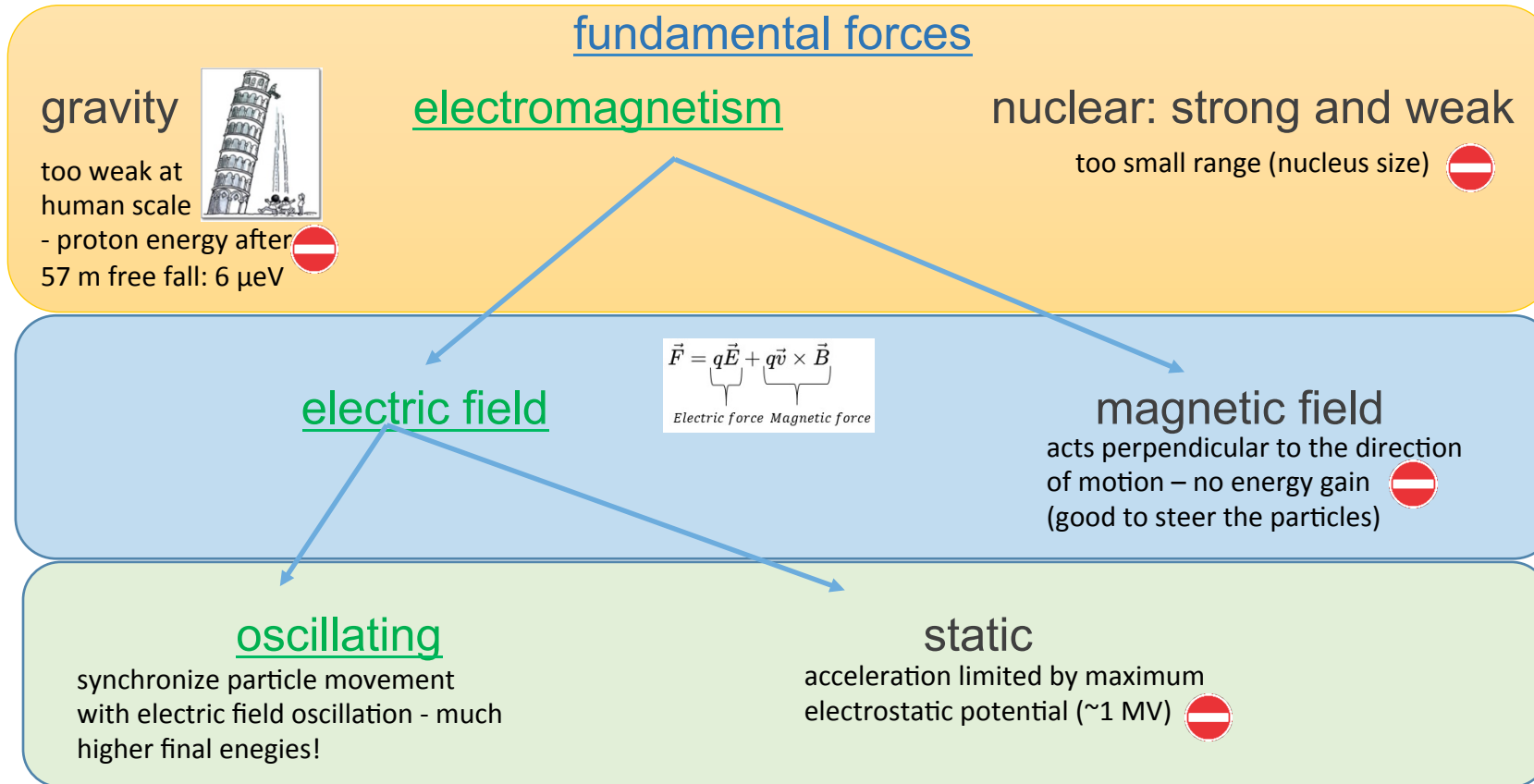



# Accelerating cavity

1. Metallic (copper) or superconducting structure with a special geometry:
2. The **electric field** vector oscillates in the beam direction
3. Sometimes it is called a **resonator**, because usually it operates at narrow resonating frequency, what is crucial for energy efficiency
4. Some cavities are tunable in wide range of frequencies (Finemet cavities in synchrotron: 470 kHz-3.26 MHz)
5. **Injector linac** of all 4 European facilities and Shanghai: 216.8 MHz
6. **Accelerating gradient** reach maximum 18 MV/m (average 5 MV/m)
7. Higher frequency = smaller dimensions and higher accelerating gradients
8. For instance CLIC structures reach 100 MV/m at 12 GHz (electrons)

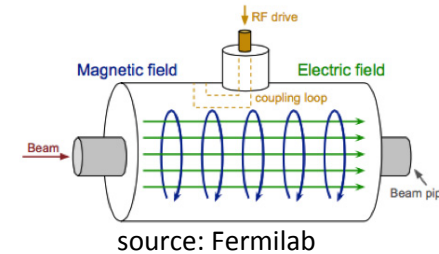

# RF accelerators - typology

1. Linacs
2. Synchrotrons
3. Cyclotrons
4. Fixed-Field Alternating Gradient (FFA)
5. Synchrocyclotrons, Fast-cycling synchrotrons

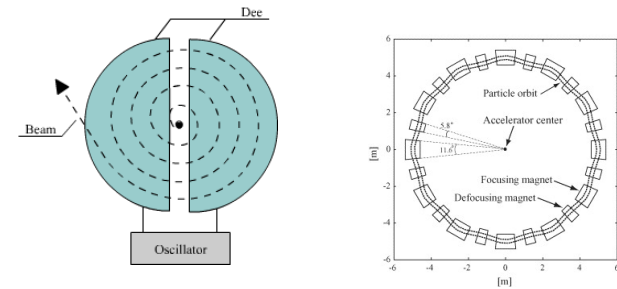
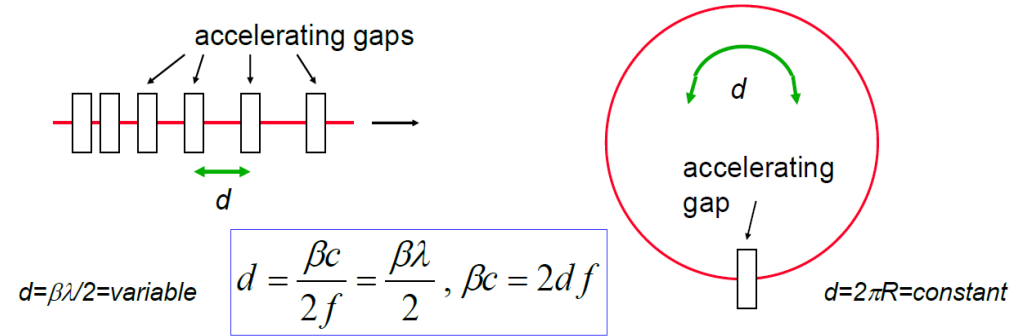

<https://doi.org/10.1016/j.tusengdes.2006.07.061>

Non-RF accelerators: electrostatic, dielectric and plasma



# Ion therapy system

Choice for ion therapy: **synchrotron-based system**, because:

1. It is easy to configure for **various ion types** (p,  $^3\text{He}^{2+}$ ,  $^4\text{He}^{2+}$ ,  $^{12}\text{C}^{6+}$ , etc...)
2. It is easy to **change output energy** and no significant losses/radiation are generated (in opposition to cyclotrons)
3. Therefore, all existing carbon therapy centers are based on synchrotrons

However:

Beam is generated in pulses with total intensity currently limited by technical and safety considerations;

Some work is required to adapt synchrotrons to FLASH therapy requirements, it is easier for cyclotrons.

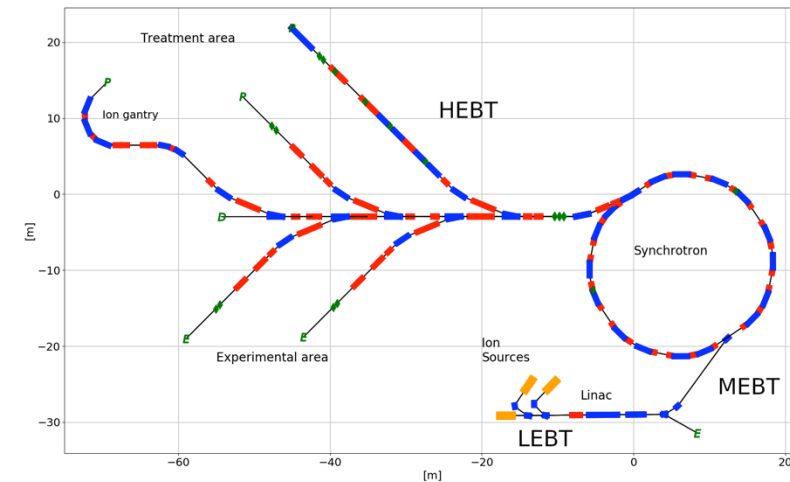

# Ion sources

1. There are many types of ion sources, for ion therapy usually commercial Electron-Cyclotron Resonance (ECR) sources are used
2. The choice is based on reliability, operational simplicity, **beam intensity** and **emittance**

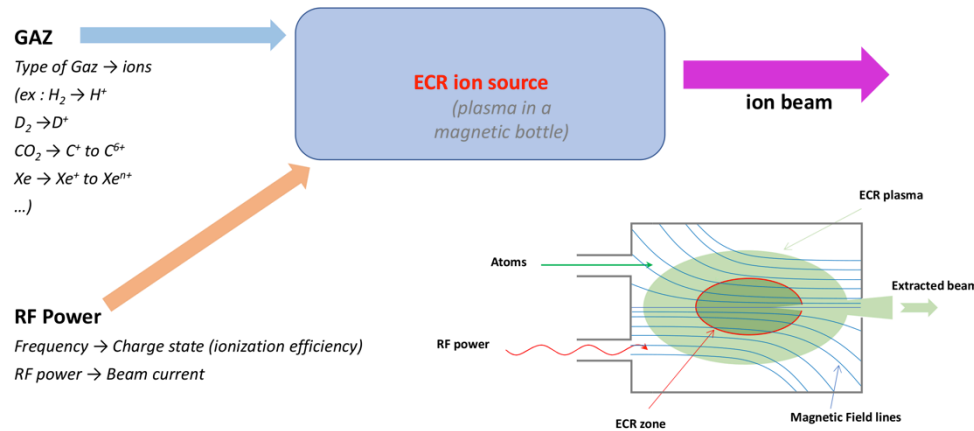

source: Pantechnik

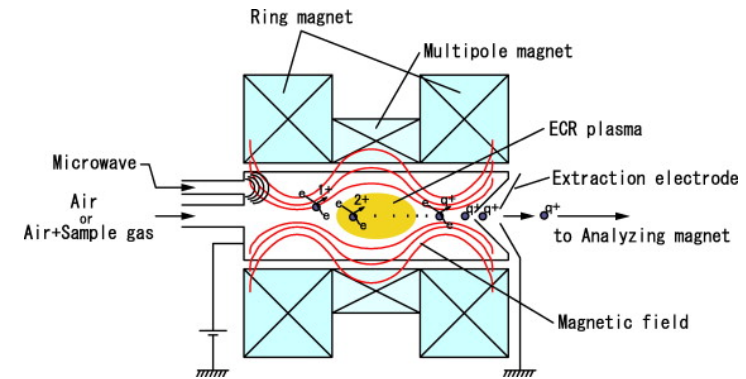



# NIMMS ion sources

Currently European centers used Pantechnik Supernanogan sources and Japan centers use Kei-series sources. Both types are based on permanent magnets

	Supernanogan	Kei-series
current of C <sup>4+</sup> ions	200-250 $\mu$ A	200-400 $\mu$ A
frequency	14 GHz	10 GHz
operation	CW	pulsed
gas	CO <sub>2</sub>	CH <sub>4</sub>

**NIMMS will need C<sup>4+</sup> current about 600  $\mu$ A.** New sources:

- RF frequency 18 GHz.
- Superconducting magnets.

INFN **AISHa** source will start operation in CNAO this year. Similar sources are being operational in Japan.

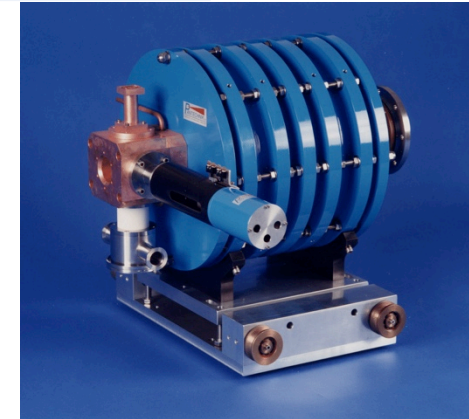

# Ion source extraction system

Ions must be pre-accelerated to after the ion source to minimize space-charge effects:

- Legacy EU linac: 8 keV/u (C4+) ie. 24 kV
- NIMMS: **at least 15 keV/u (45 kV)**
  - Body of the source – 0V
  - Puller electrode – -25.50kV
  - Focusing electrode – -45.0kV
  - Ground electrode – -30kV.

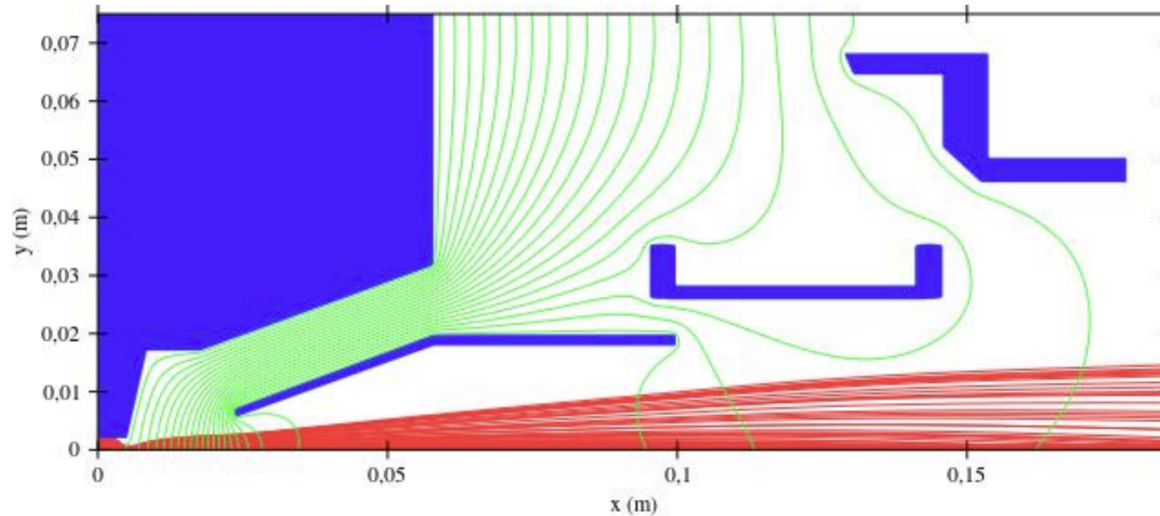

source: B. Dedic, MSc thesis  
Sarajevo University 2021



# Multiple sources

Reliability and various ions (p, He, C)

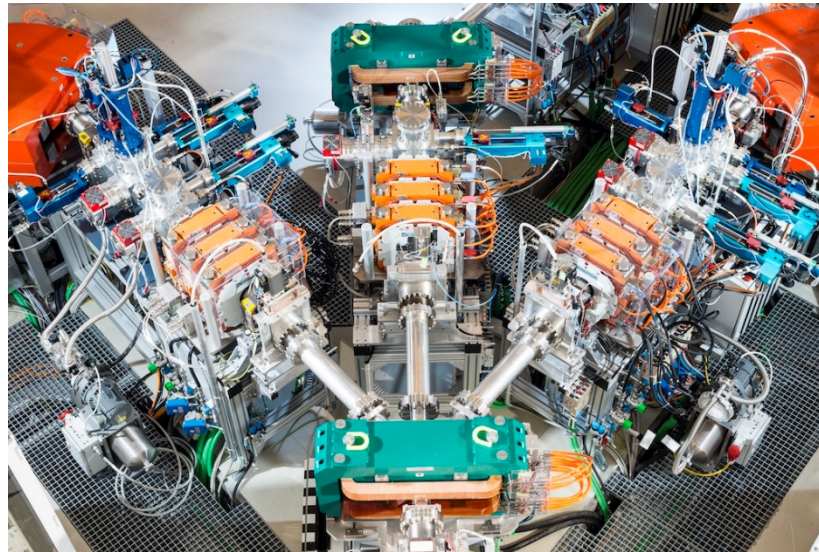

MedAustron

# Injector linac

1. Beam must be accelerated from  $\sim 8$  keV/u to injection energy of synchrotron: 4-10 MeV/u
2. State of art: **Radio-Frequency Quadrupole (RFQ) + Drift-Tube Linac (DTL)**

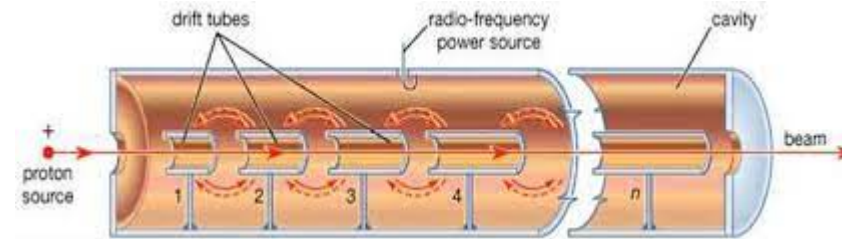
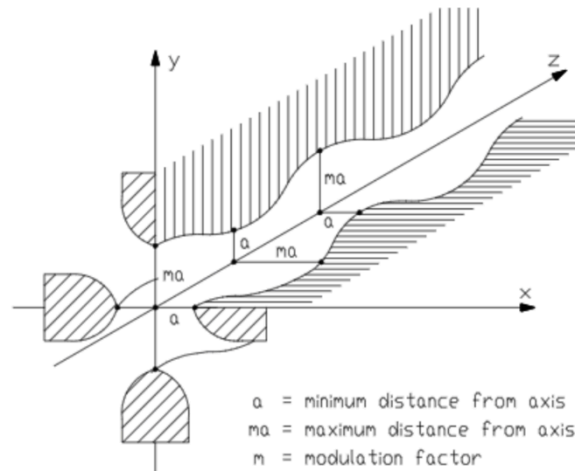

3. Cyclotrons - direct injection – no linac

# Injector linac - RFQ

1. RFQs tasks:
  - **Bunching** – beam from source is continuous
  - **Focusing** – alternate gradient – space charge
  - **Accelerating** – not efficient at higher energies  
typical output Energy: 400 keV/u – 5 MeV
2. Radiation protection:
  - below 2 MeV (for protons) - negligible activation (copper)
  - during operation X-ray emission is present due to brehmsstrahlung
3. Current RFQs:
  - EU: 216.8 MHz, max energy of 400 keV/u, 10 Hz rep rate, Q/M=1/3
  - Japan: 200 MHz
4. NIMMS choices:
  - Carbon machine: **352 MHz** (Linac4 technology) with final energy of 2-3 MeV/u and 10% duty factor (radioisotope production), Q/M=1/3
  - Helium machine: **750 MHz** 3D-printed RFQ, Q/M=1/2
  - **217 MHz** redesigned for higher duty factor

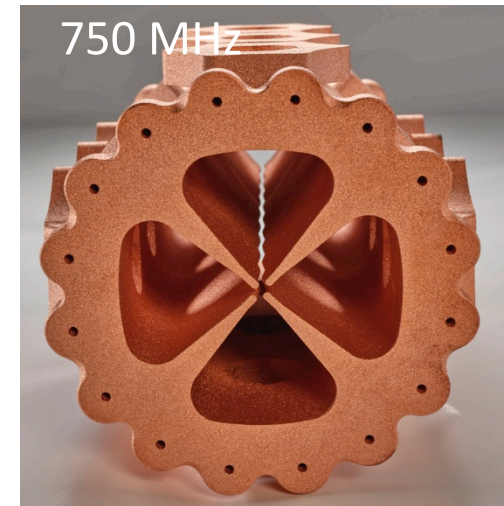
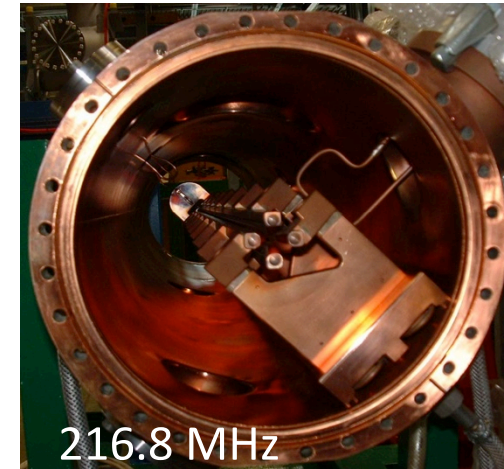

# Legacy Injector

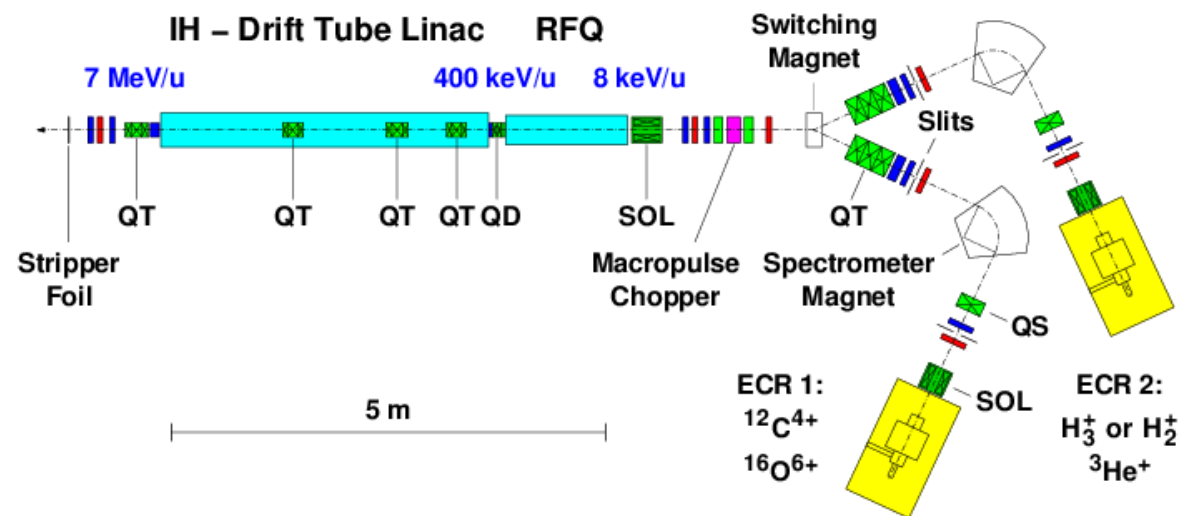



# Injector linac - DTL

1. Drift-Tube linac (DTL) structure is much more efficient accelerator than RFQ
2. EU centers employ 216.8 MHz IH-type linac accelerating  $C^{4+}$  or  $H_3^+$  up to 7 MeV/u, final stripping before injection to synchrotron
3. Japan experimented with lower final energy 4 MeV/u and 200 MHz structures
4. NIMMS, 3 tanks, all 352 MHz DTL:
  - first tank: 5 MeV/u ( $C^{4+}$ )
  - second tank: 7.1 MeV/u for radioisotopes, e.g.  $^{209}Bi(^4He, 2n)^{211}At$
  - third tank: 10 MeV (proton injection)
  - stripping foil ( $C^{4+} \rightarrow C^{6+}$ ) after the last tank.

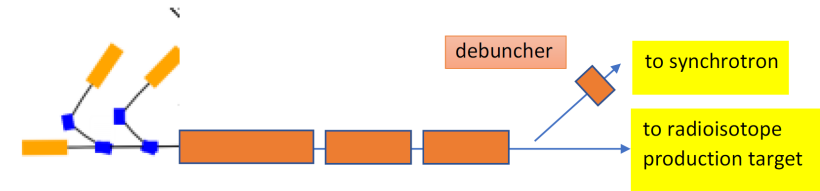

3 ion sources $^{12}C^{4+}$ , 600 $\mu A$ , 0.25 $\pi$ mm mrad, 45 kV (AISHa) (7.5mA C4+ limit design current) $^4He^{2+}$ , 0.5 mA, 0.3 $\pi$ mm mrad (Supernanogun) P or $H_2^+$ , 5 mA, 0.2-0.3 $\pi$ mm mrad (emittances rms normalised)	Linac section1	Linac section2	Linac section3	Maximum duty cycle: 10%
	$q/m=1/3$ $W_{in}=15$ keV/u $W_{out}=5$ MeV/u	$q/m=1/2$ $W_{in}=5$ MeV/u $W_{out}=7.1$ MeV/u	$q/m=1/2$ or 1 $W_{in}=7.1$ MeV/u $W_{out}=10$ MeV/u	
	Version 1 : 217 MHz Version 2 : 352 MHz			

# Synchrotron – key components

$$\vec{F} = q\vec{E} + q\vec{v} \times \vec{B}$$

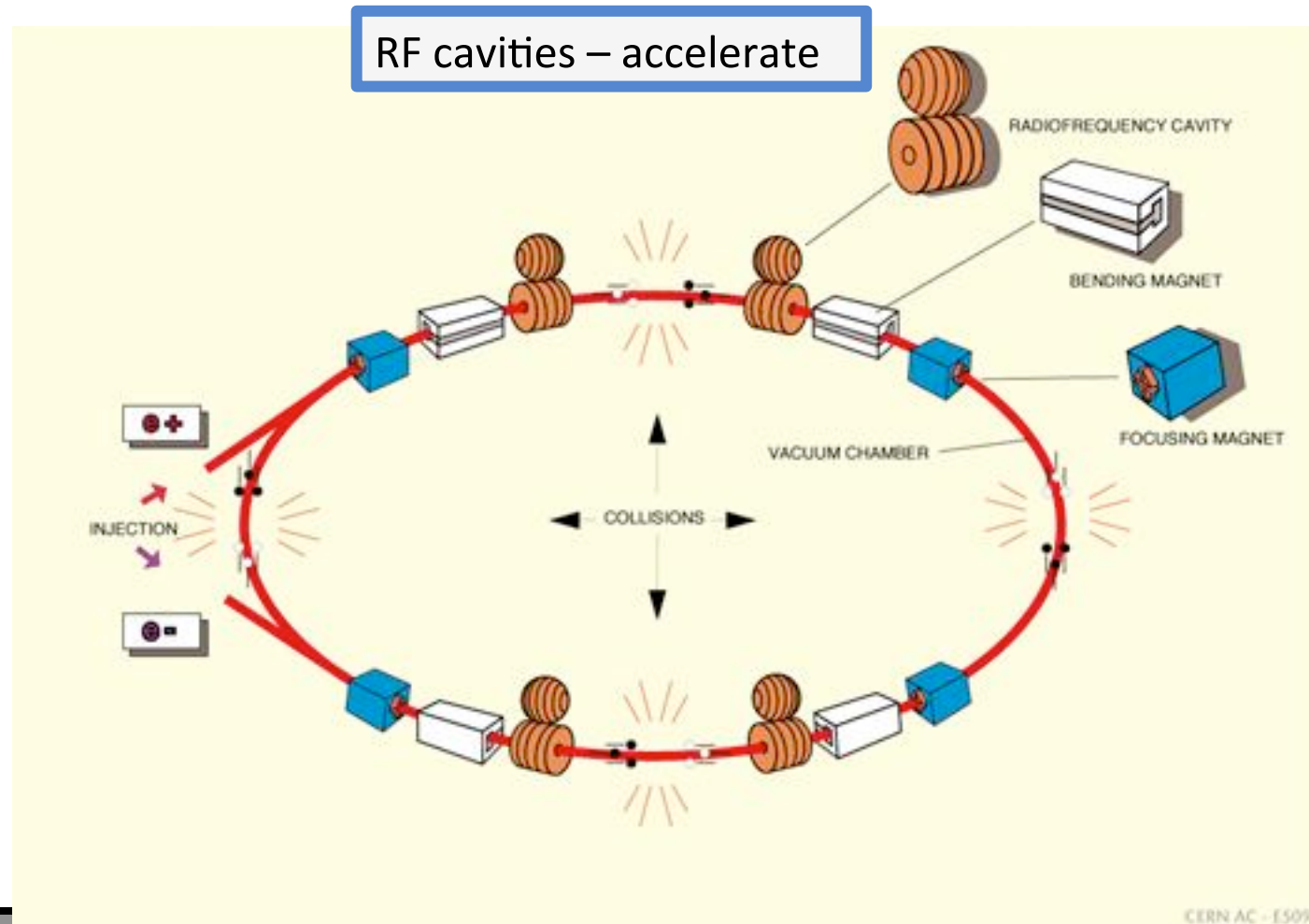

# Synchrotron – key components

$$\vec{F} = q\vec{E} + q\vec{v} \times \vec{B}$$

RF cavities – accelerate

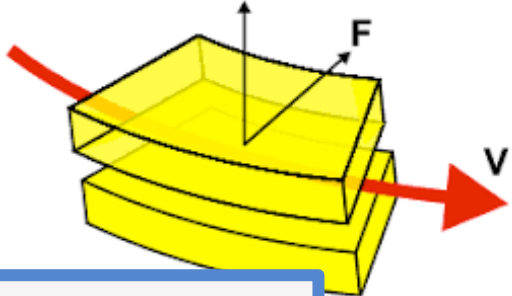
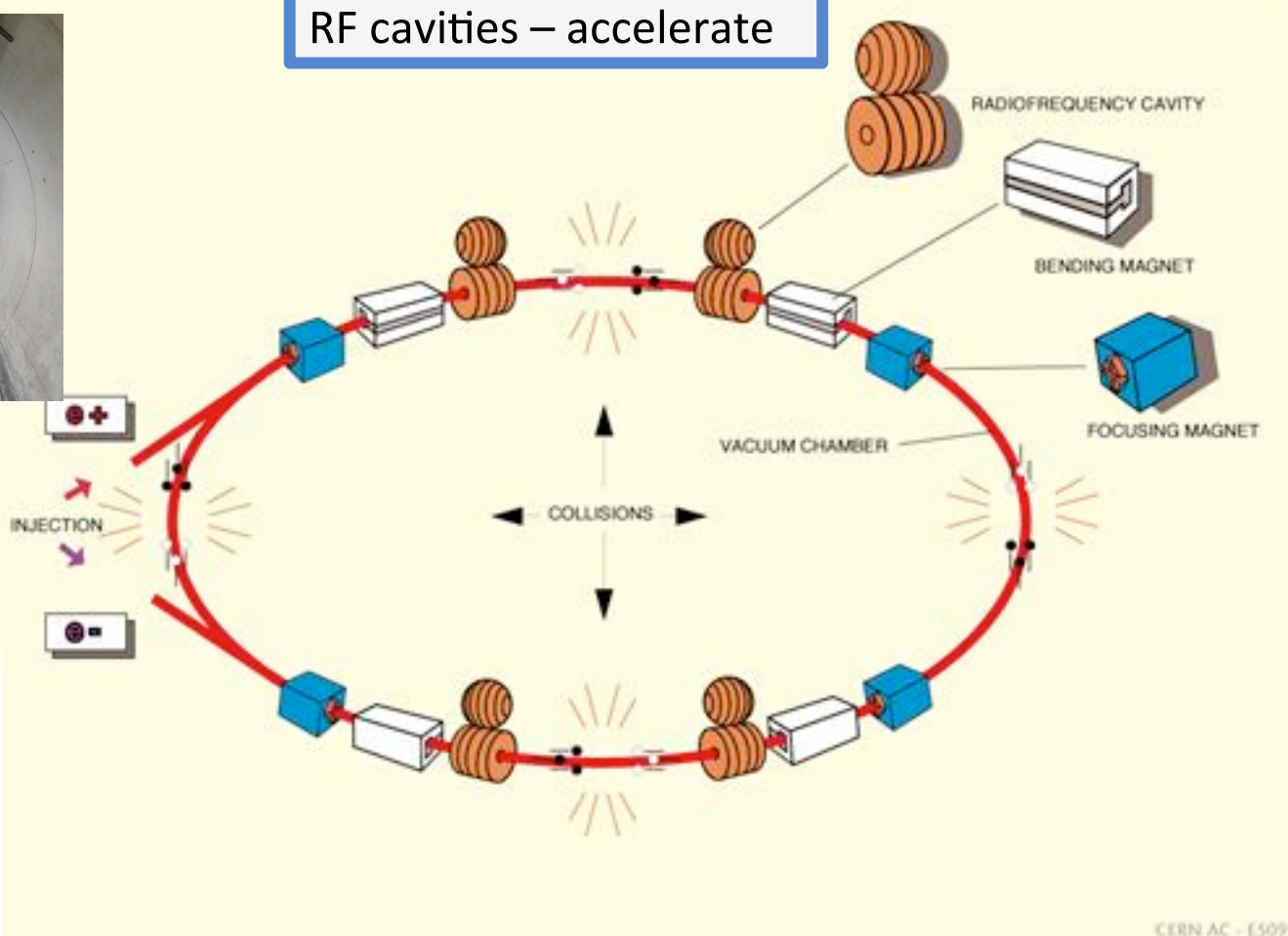
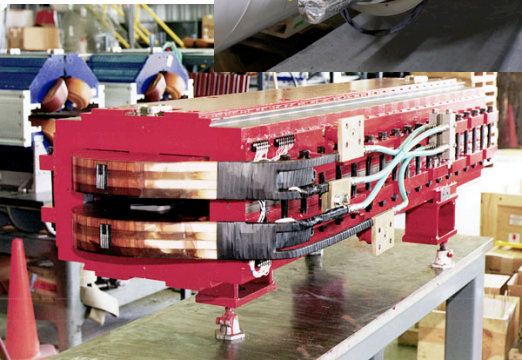
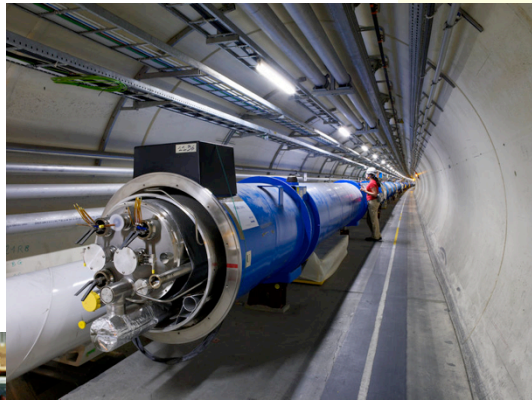

Dipoles – bend

CERN AC - E509





# Synchrotron – key components

$$\vec{F} = q\vec{E} + q\vec{v} \times \vec{B}$$

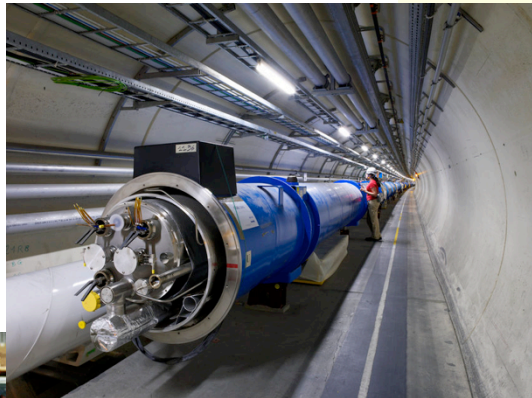

RF cavities – accelerate

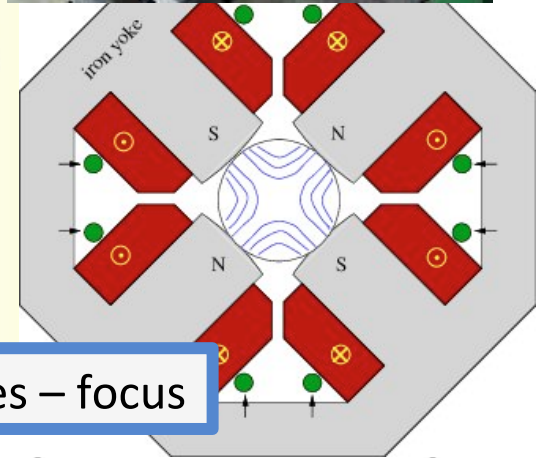
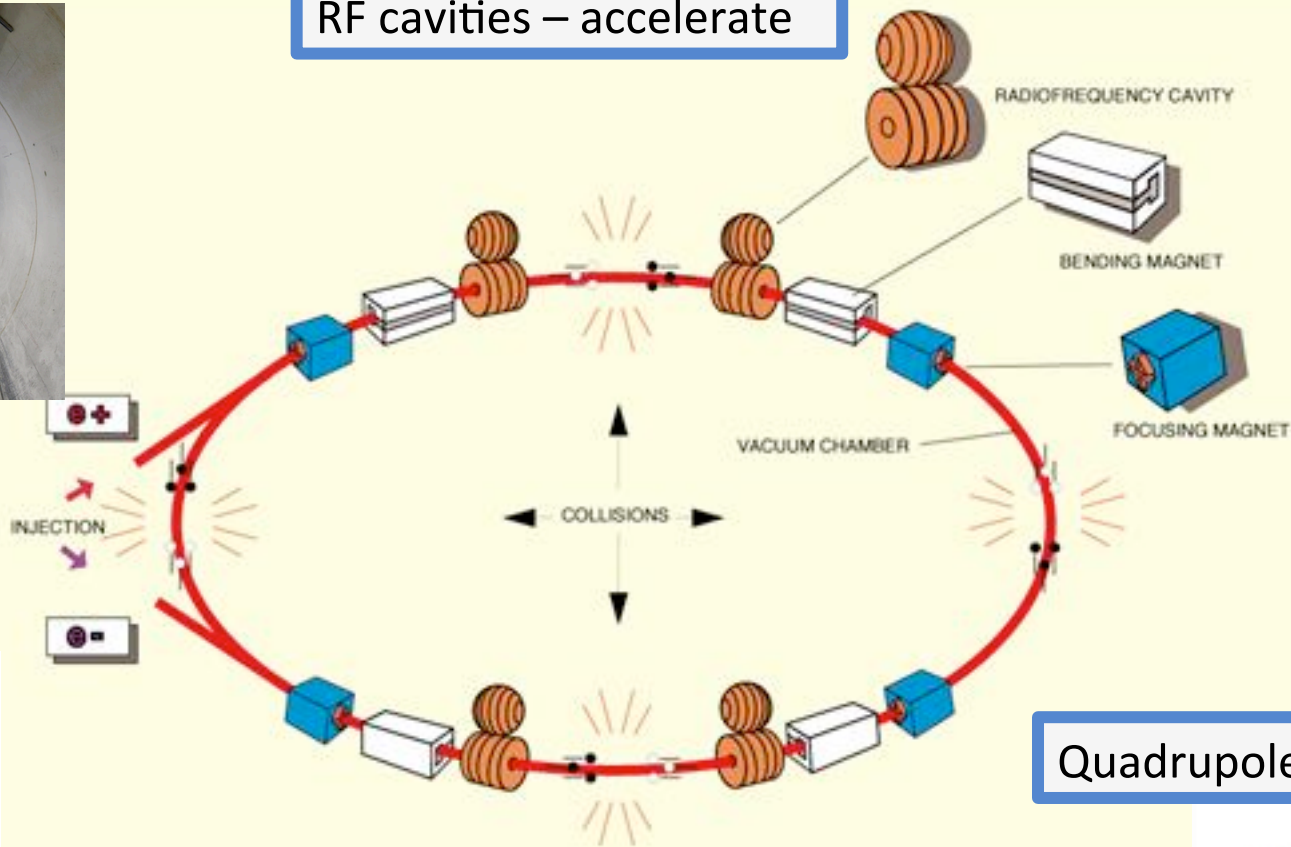

Quadrupoles – focus

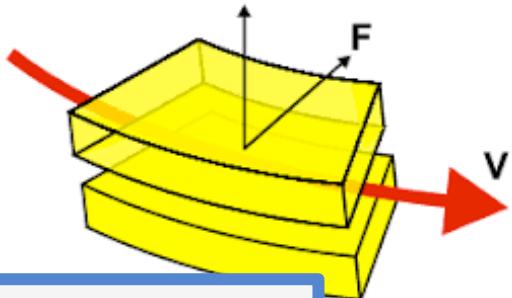
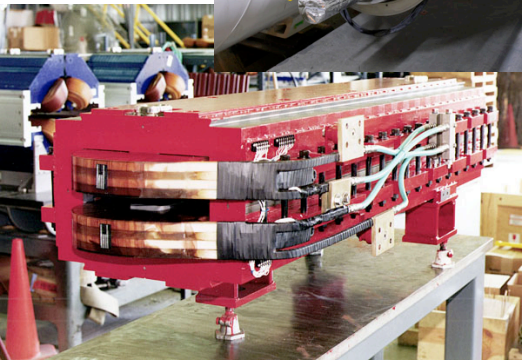

Dipoles – bend

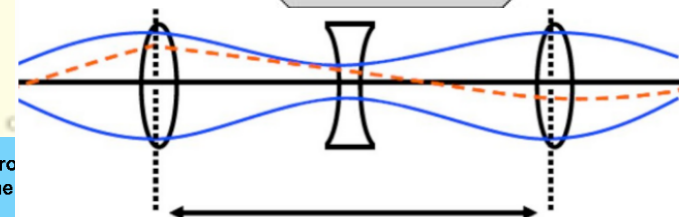



# Synchrotron – beam dynamics in a few slides...

**Rigidity:** “how difficult” is to bend the beam

$$qvB = \frac{mv^2}{\rho} \Rightarrow B\rho = \frac{p}{q}$$

electrons @ 20 MeV:  $B\rho=0.068$  T m  
protons @ 250 MeV:  $B\rho=2.43$  T m  
C-ions @ 430 MeV/u:  $B\rho=6.6$  T m

$B$  = Magnetic field < 1.5T (normal conducting magnets)

$\rho$  = Radius of curvature is 1.6m (protons) vs. 4.4m for C-ions

**Let's use superconducting magnets!!!**  
 **$B > 3\text{T}$ ,  $\rho < 2.2\text{m}$  for C-ions**

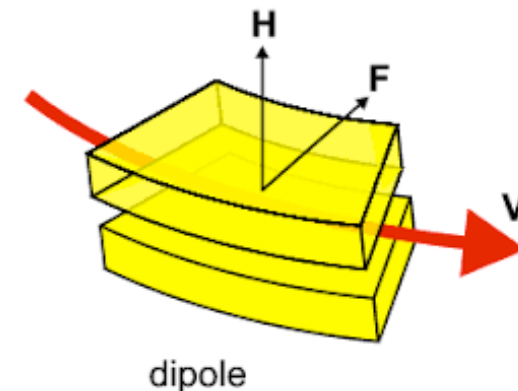

# Synchrotron – beam dynamics in a few slides...

- **Reference orbit:** The particles (and the entire beam) oscillate around the synchrotron reference orbit.

- **Tune:** the number of (betatron) oscillations per turn, in x or y
  - must not be an integer N, nor N/2, N/3,...

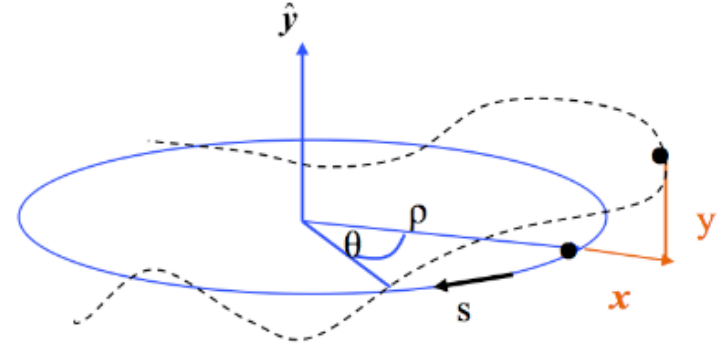

- **6D phase space:** at a given time t, a particle is identified by its 6 coordinates:
  - Position in x,y,z i.e. the deviation from reference trajectory
  - Divergence x',y' and momentum offset  $\delta$



the divergence is  $\sim$  the angle of the momentum with respect to the longitudinal coordinate s

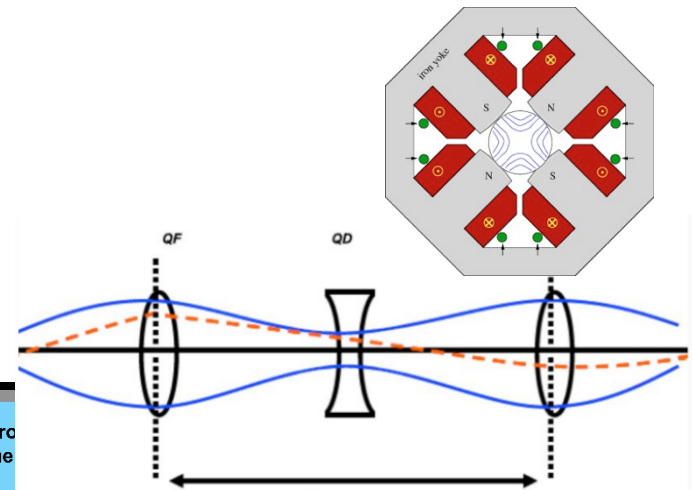

# Synchrotron – beam dynamics in a few slides...

- Hills equation:  $x''(s) + K(s) x(s) = 0$  (similar in the y-plane, valid if no coupling)

$$\begin{cases} x(s) = \sqrt{\beta_x(s)} J_x \cos(\mu_x(s) + \mu_{x,0}) \\ x'(s) = -\frac{\sqrt{J_x}}{\sqrt{\beta_x(s)}} \{ \alpha_x(s) \cos(\mu_x(s) + \mu_{x,0}) + \sin(\mu_x(s) + \mu_{x,0}) \} \end{cases}$$

## “Accelerator” ellipse:

I sit at a position in the ring and look at the position of a particle, turn after turn.  
If the tune is not  $N, N/2, N/3, \dots$  it will describe the entire ellipse

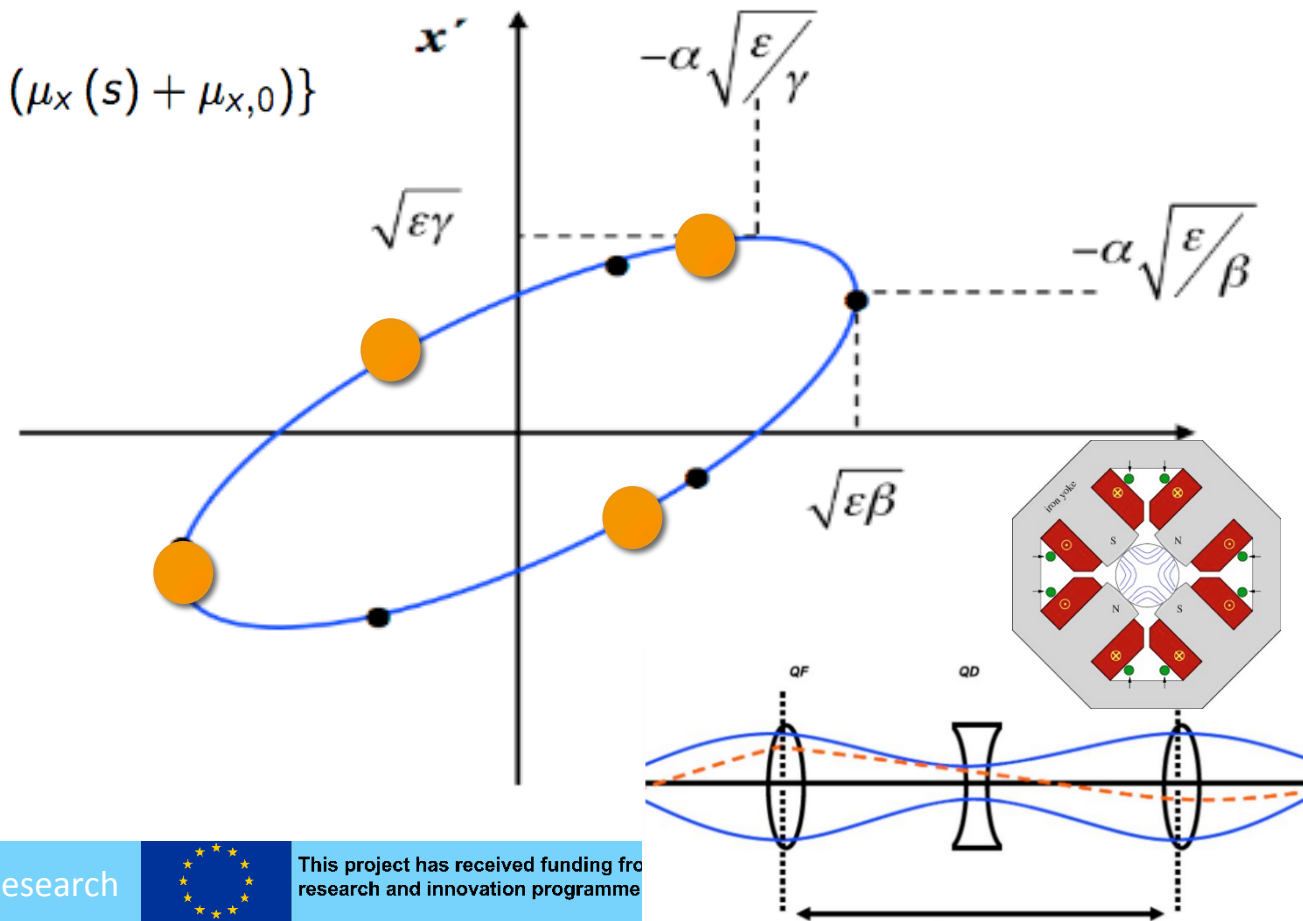

# Synchrotron – beam dynamics in a few slides...

## “Beam” ellipse:

The ensemble of particles form an ellipse, which area ( $\sim$ Emittance), is constant (Liouville).

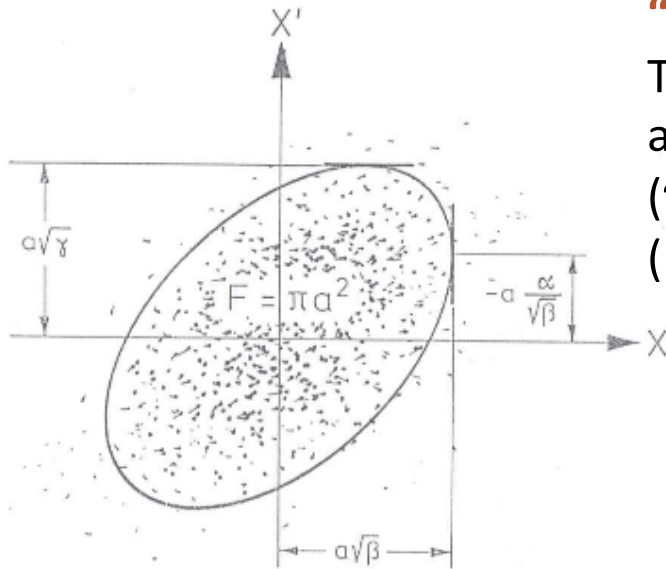

In a synchrotron, the “accelerator” and the “beam” ellipse have the same shape and orientation

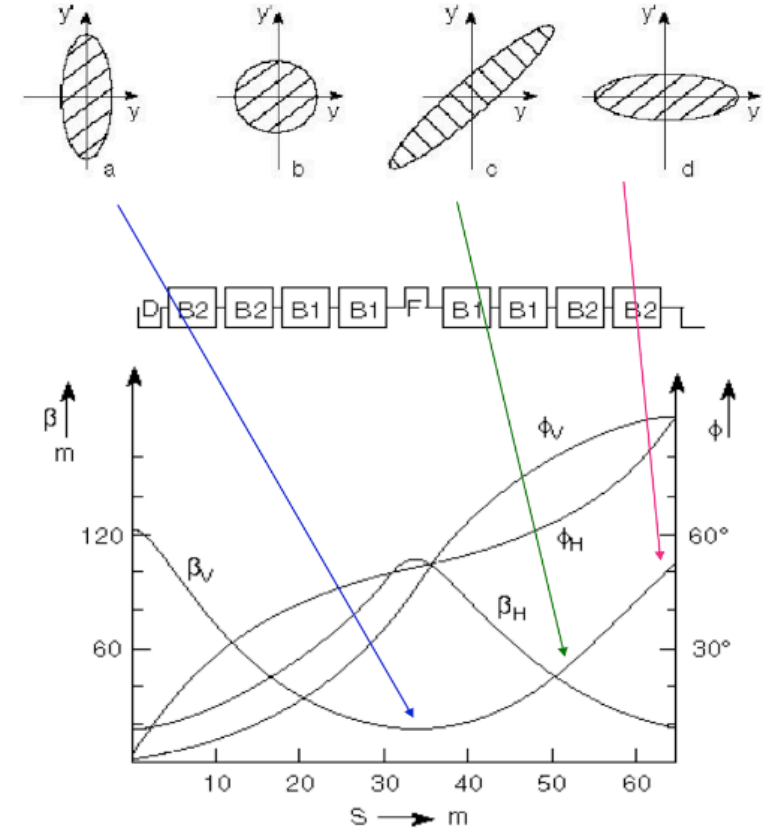

**Beam envelope:** proportional to  $\sim \sqrt{\text{Beta function}}$ :

- periodic in a ring
- **dependent on initial condition in a transfer line!!!**





# SEEIIST Synchrotron

PIMMS design (C=75m) – baseline for SEEIIST  
higher intensity x20

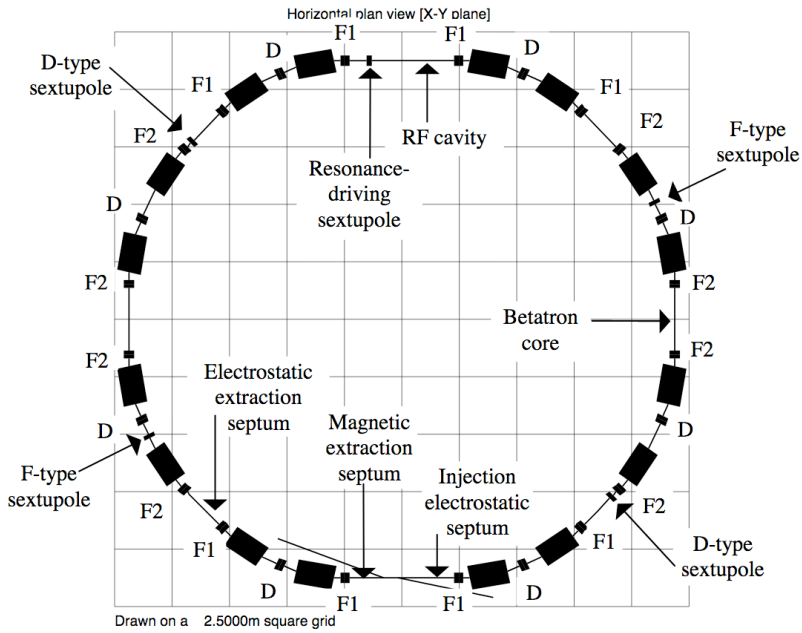

<https://cds.cern.ch/record/449577?ln=en>



CNAO, implementation of PIMMS design

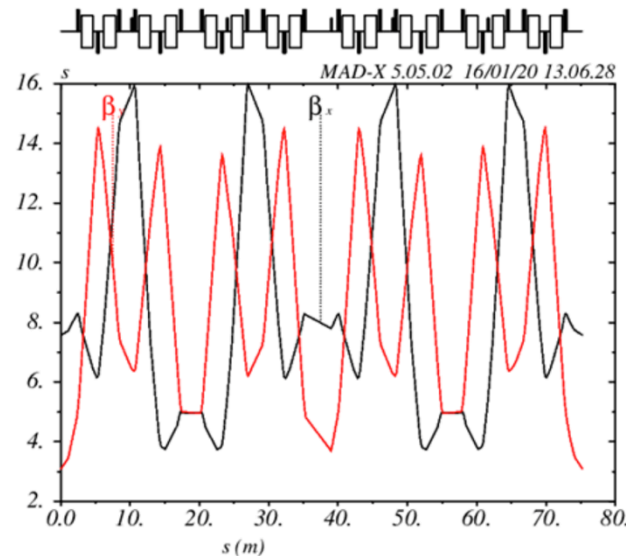
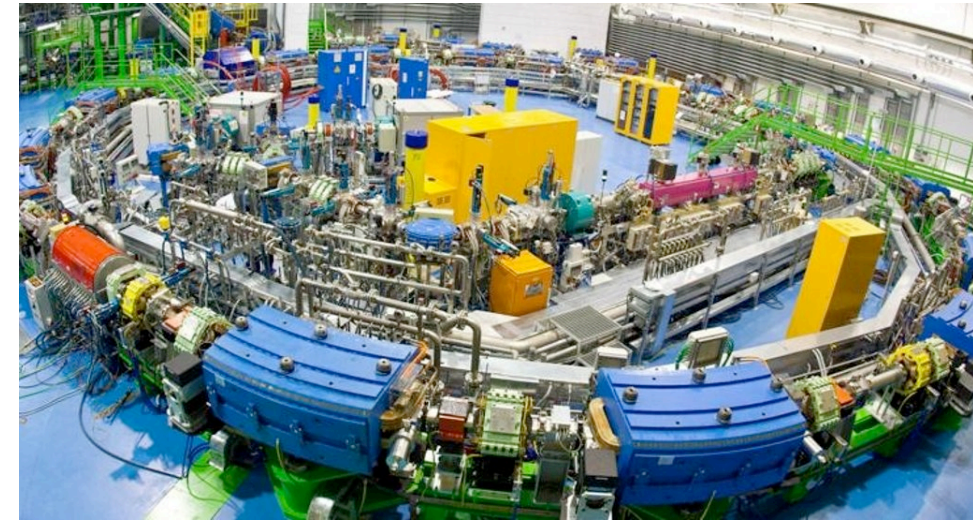

Simulations with MADX (Courtesy A.Advic, U.Sarajevo):  
PIMMMS beta functions along the ring



# SEEIIST synchrotron, Superconducting magnets option

Compact (C=27m), based on 90°  
3.5T magnets (@TERA).

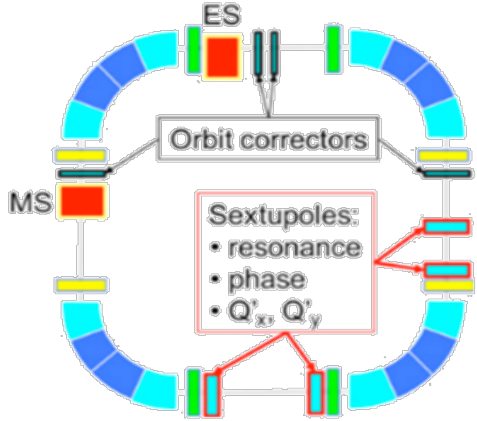

E. Benedetto, U. Amaldi et al,  
<https://arxiv.org/abs/2105.04205>

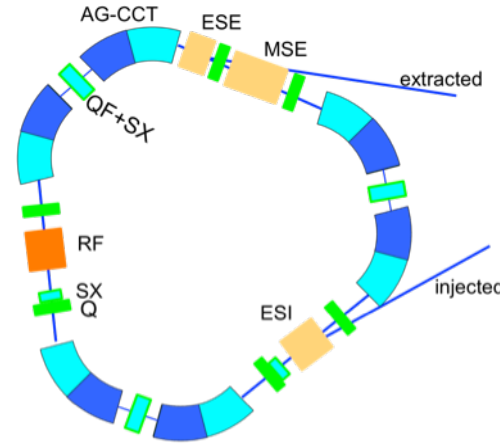

Developed within HITRIplus (EB et al.)  
Evolved to triangular, with 3.5 T 60° magnets  
and a SC quadrupole in between.  
No-dispersion in straight sections (inj, extr, RF)

AG-CCT magnets allow periodic  
focusing while bending, reducing  
beta function (and beam size)

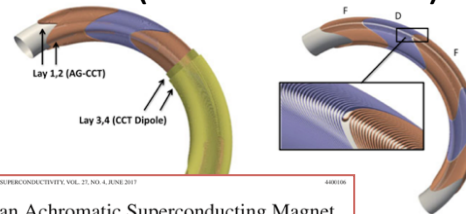

Design of an Achromatic Superconducting Magnet  
for a Proton Therapy Gantry  
L. Brouwer, S. Caspi, R. Hafid, A. Hodgkinson, S. Prestemon, D. Robin, and W. Wan

...based on this, development in parallel  
of a Helium Ring (warm magnets, 33m  
circunferenece) within NIMMS

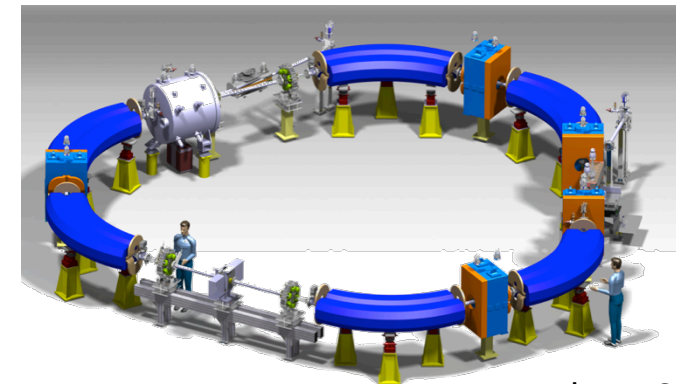

M. Vretenar et al, IPAC22

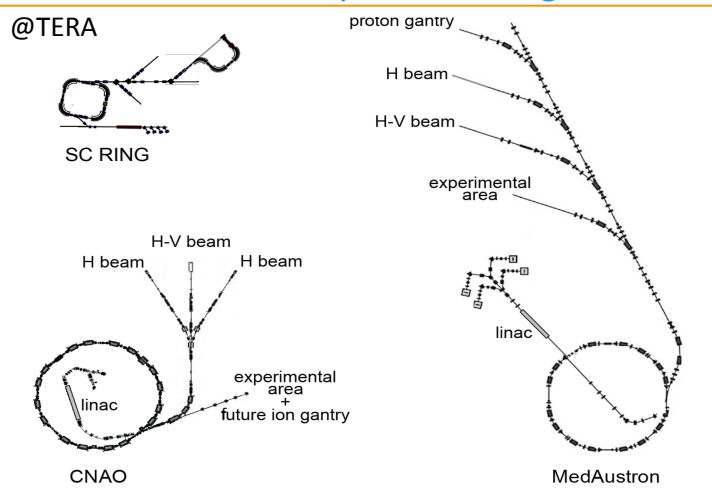

# SC Strongly-Curved CCT magnets

## Nb-Ti CCT: p-gantry and HiLumi LHC

**LBNL:** CCT coil prototype for large acceptance proton gantry  $\varnothing = 400$  mm: Successfully tested to 3.5 T; segmented former.

**HiLumi LHC:** CERN has designed, built and tested a dual 3 T, 2 m long -  $\varnothing = 105$  mm, straight CCT. Now IHEP Beijing producing 2x13 units

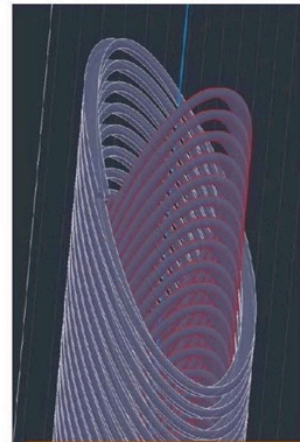

Proto 2m 2.9 T 105 mm very successful at CERN. However, learning and transfer not easy (China..., SE)...

L. Rossi

ROSSI - NIMMS MEETING - INFN PROGRAM -

8

see L. Rossi on magnets

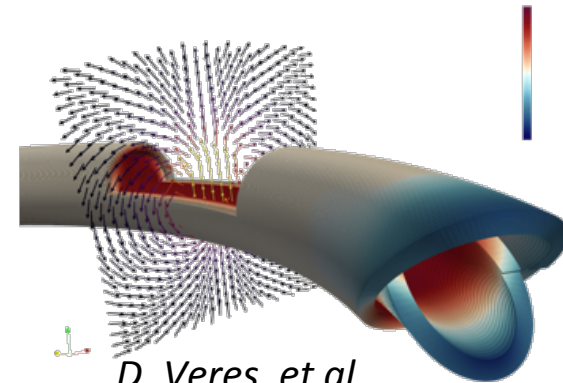

D. Veres, et al.

Parameter	Synchrotron magnet	Prototype Magnet
$B_p$ (Tm)	6.6	6.6
$B_0$ dipole (T)	3.0	4-5
Coil apert. (mm)	70-90	60 (90)
Curvature radius (m)	2.2	2.2, $\infty$
Ramp Rate (T/s)	1	0.15-1
Field Quality ( $10^{-4}$ )	1-2	10-20
Deflecting angle	90°	0 - 45°
Alternating-Gradient	yes (triplet)	N/A
Quad gradient (T/m)	40	40
$B_{quad}$ peak (T)	1.54- 1.98	1.2
$B_{peak}$ coil (T)	4.6 - 5	5.6-7
Operating current (kA)	< 6	< 5
Type of Superconductor	NbTi (Nb <sub>3</sub> Sn)	NbTi (curved), HTS (straight)
Operating temperature (K)	5 (8)	5 (20)

Several prototypes will be built in ~3y from now

Field Quality in strongly curved magnets (& modeling challenges)

Study group HITRIplus E.Benedetto, D.Barna  
 → use generalized gradients Vs. multipoles



# Flexible beam delivery requires x20 higher intensity

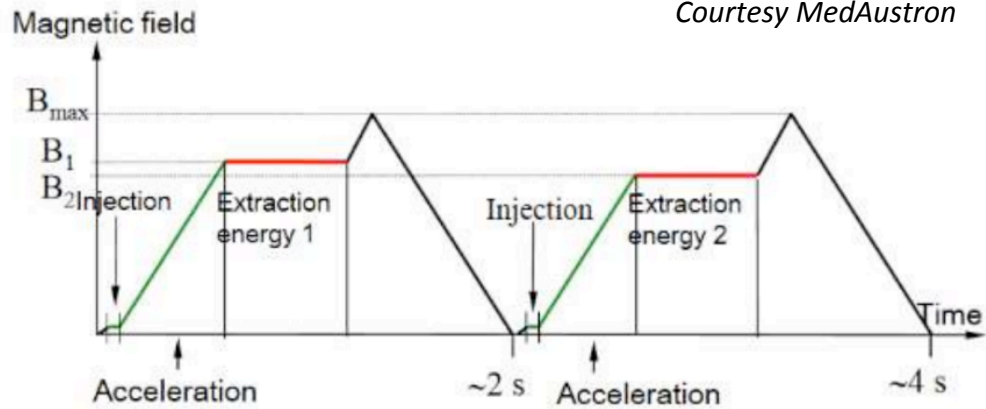

**TODAY:** Every change of energy → A different cycle

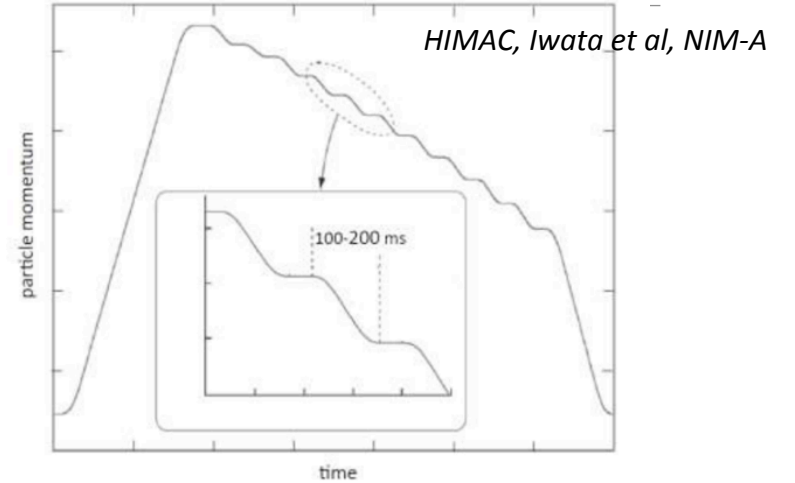

**TODAY in Japan (studies at HIT):** Multi-Energy Extraction going down (up) within same cycle



**TOMORROW(?)** ... deliver the entire \*high intensity\* beam in <500 ms



# Multi-turn injection of $2e10$ C-ions

~similar #turns  
for He-ions  
(source 1mA)

ECR source  $\sim 200$   $\mu\text{A}$  C+4

Next generation ECR (e.g. AISHA, Catania)  $\sim 600$   $\mu\text{A}$  C+4 (in 0.3 mm mrad rms)

Injecting @ 5 MeV/u in a 70 m circumference

Assume 90% (high!) efficiency from source to injection  $\rightarrow$  13 “effective turns” needed (30 for the compact 30m)

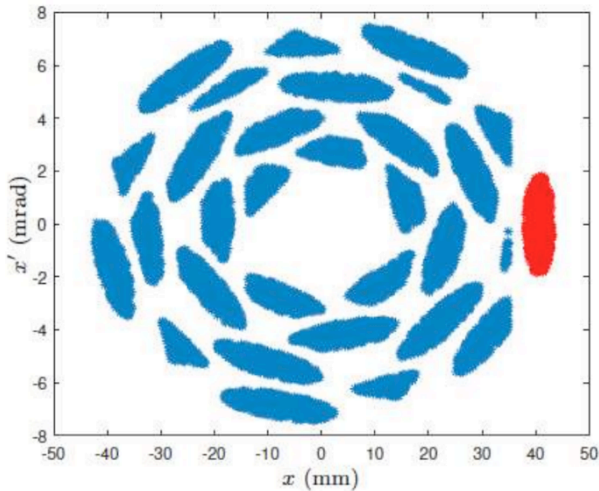

A. Advic, U. Sarajevo (2019)

Heavy Ion Therapy Research Integration

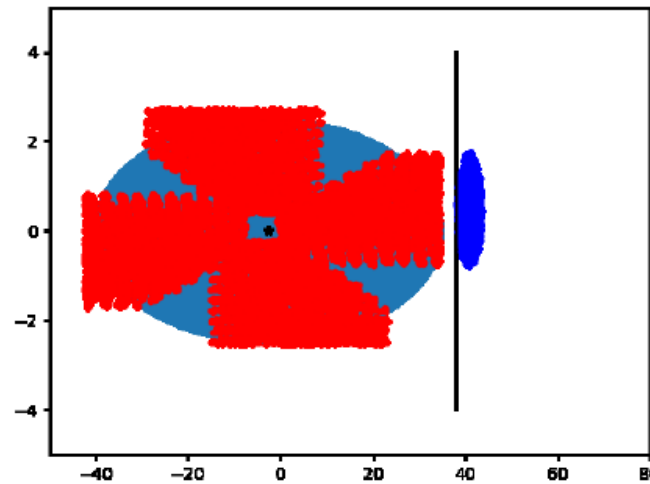

EB, playing to increase brightness

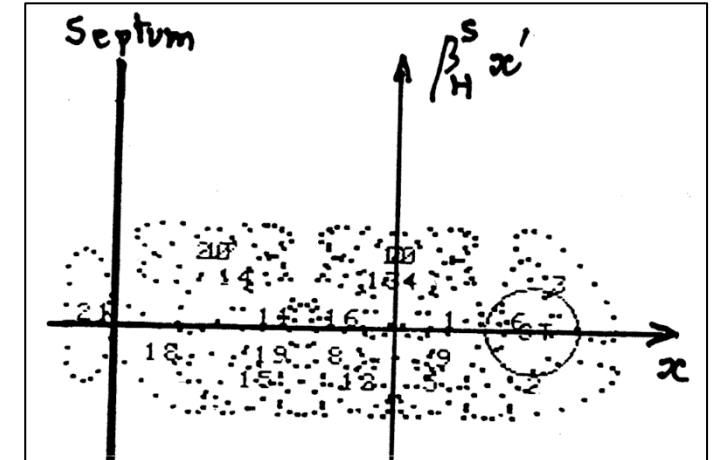

LEIR injection (S.Maury, C.Carli, D. Mohl)

# SLOW RESONANT EXTRACTION

## Beam manipulation on the 3<sup>rd</sup> order resonance

Using sextupoles and tune close to  $Q_x = \#.33$  or  $\#.67$

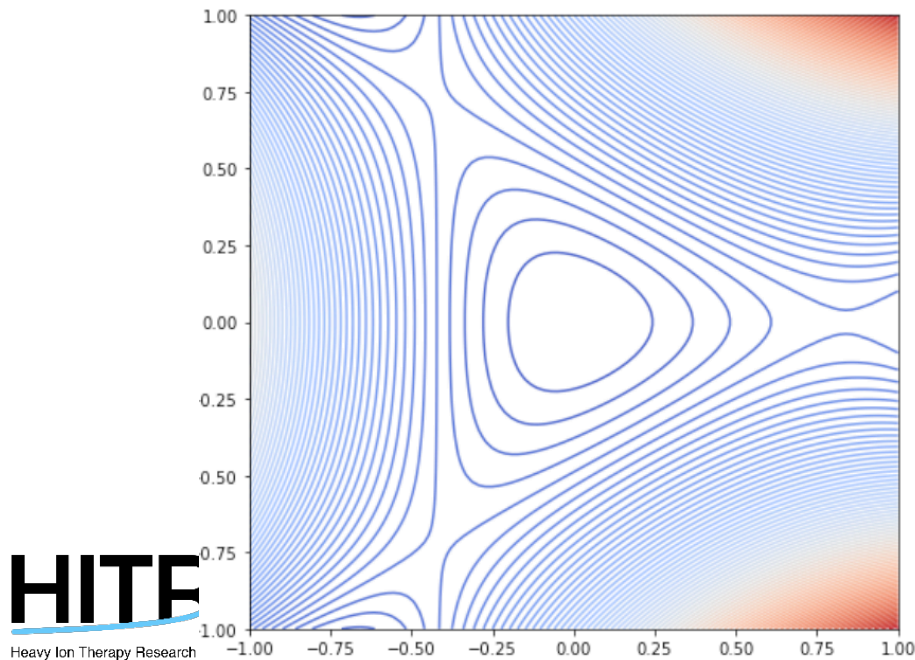

**HITE**  
Heavy Ion Therapy Research

R. Taylor

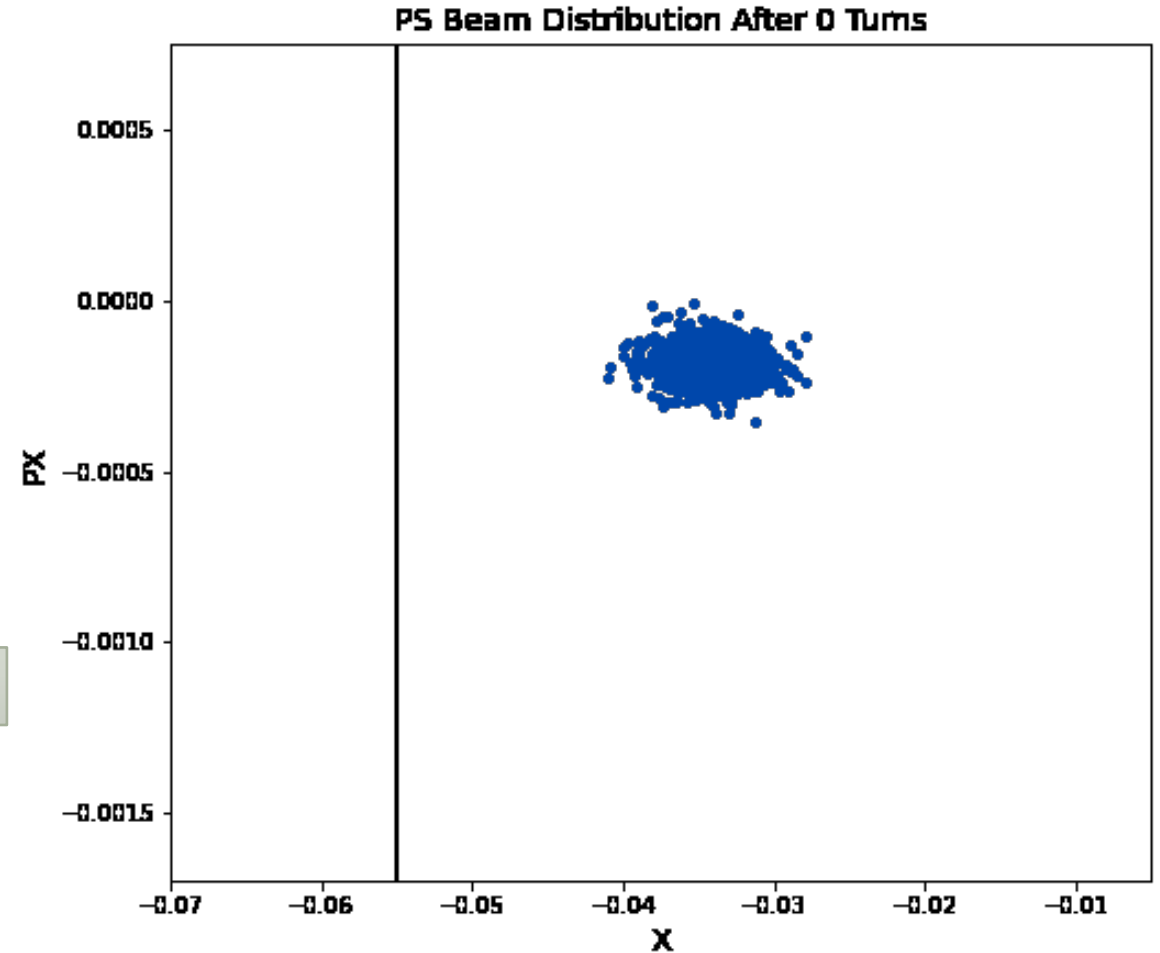

# Slow extraction on the 3<sup>rd</sup> order resonance

Rebecca Taylor,  
CERN/Imperial College

Simulations for benchmark with PIMMS (CNAO, MedAustron)

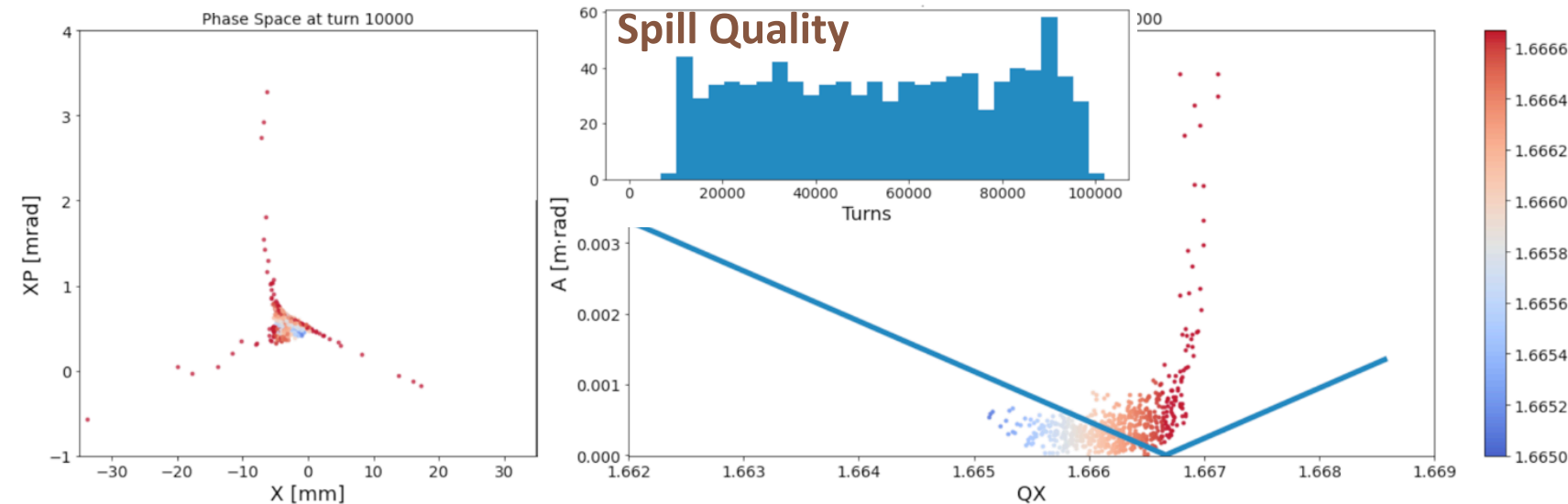

**FLASH regime, RF-KO extraction**  
 Preliminary simulations foresee  
 exciter voltage ~1kW for 10urad  
 (10x beyond hardware capability)

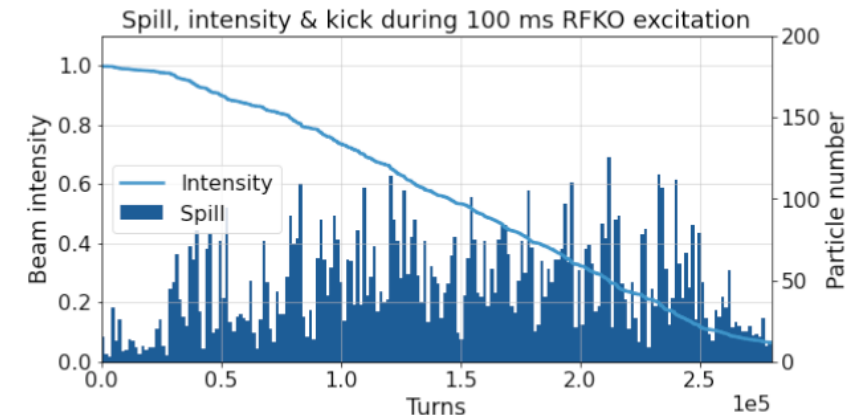



# Carbon ion gantries

electrons,  
protons & carbon  
ions have  
different **rigidity**



X-ray gantry

Heavy Ion Therapy Research Integration



IBA proton gantry



HIT carbon gantry



# Carbon ion gantries

HIMAC + TOSHIBA (Japan) gantry has superconducting magnets of 3T and weighs “only” 300 tons, compared with 600 tons of HIT

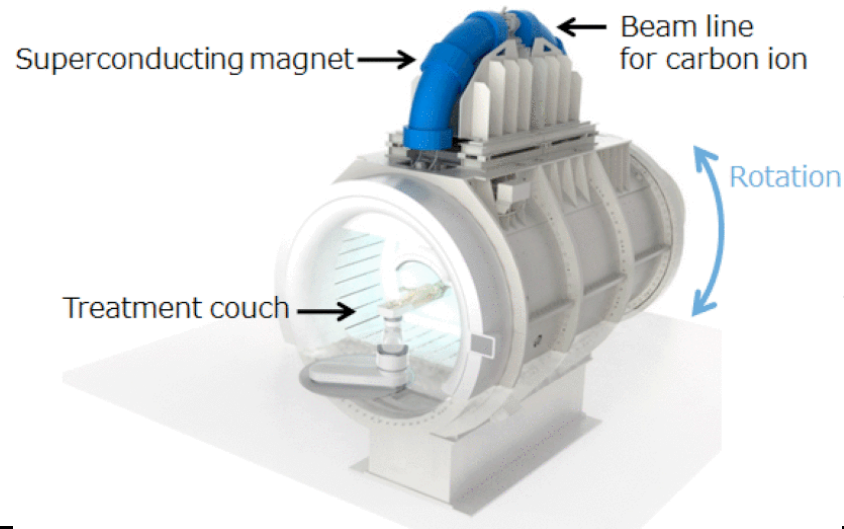
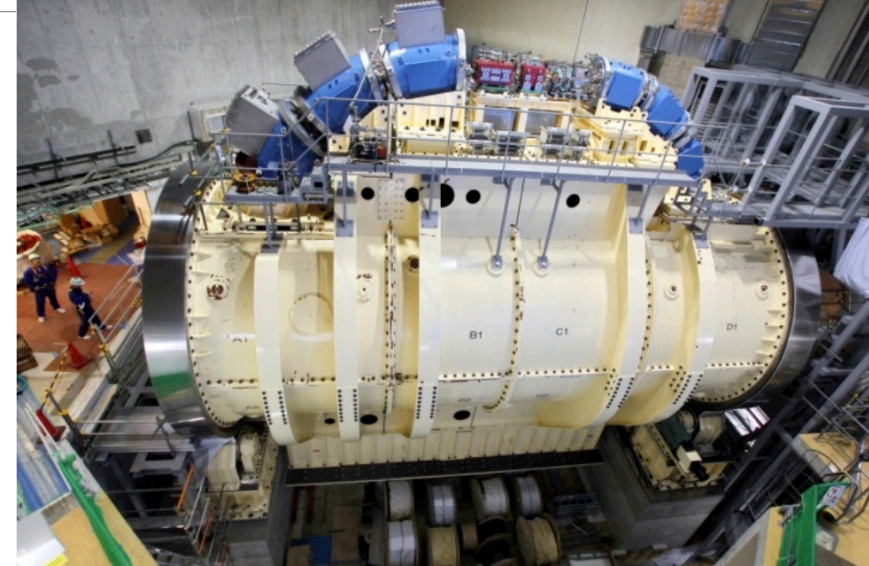

TOSHIBA installed a new one in Yamagata U. facility (3.5T magnet, more compact)

# SEEIIST Gantry

- Gantries for Carbon ions are huge, two SC gantry in Japan, studies in Europe.
- Objective: Develop a superconducting gantry with weight lower than 100 tons and length below 16 m.
- Subject: a «SIGRUM» type gantry selected by an expert committee in Dec. 2020.
- Development ongoing within HITRI $plus$

see M.Pullia on Gantries

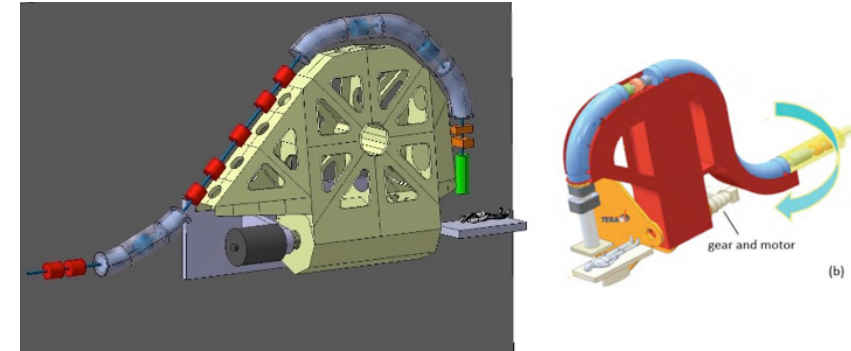

E.B.. et al, TERA, <https://arxiv.org/abs/2105.04205>  
 U. Amaldi, et. al, TERA + CERN, NIMMS-Note-002

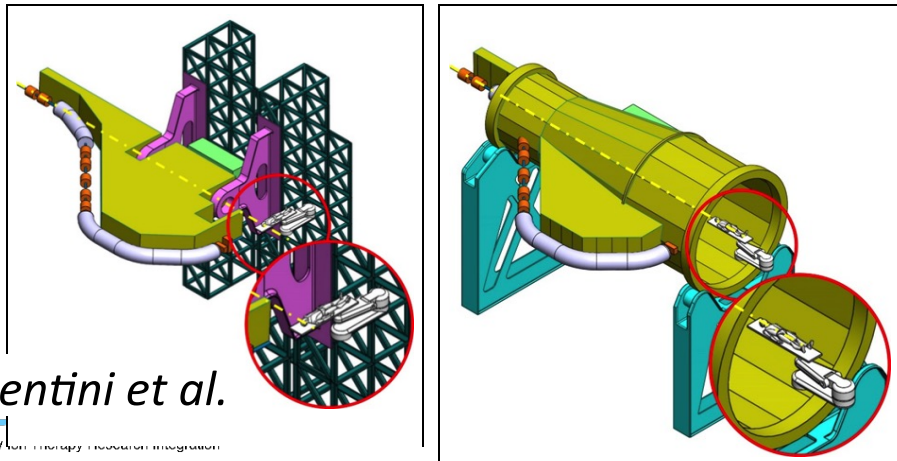

L. Piacentini et al.

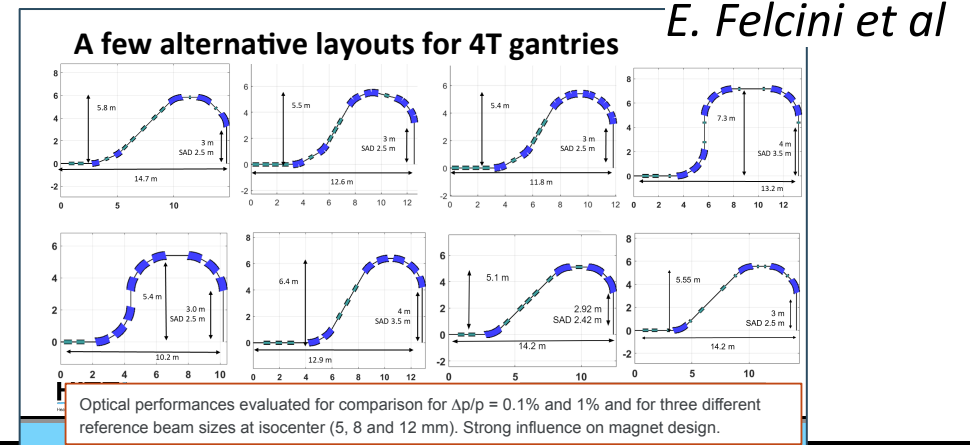

# HEBT layout

HEBT layout depends strongly on space constraints. HIT and CNAO had limited space:

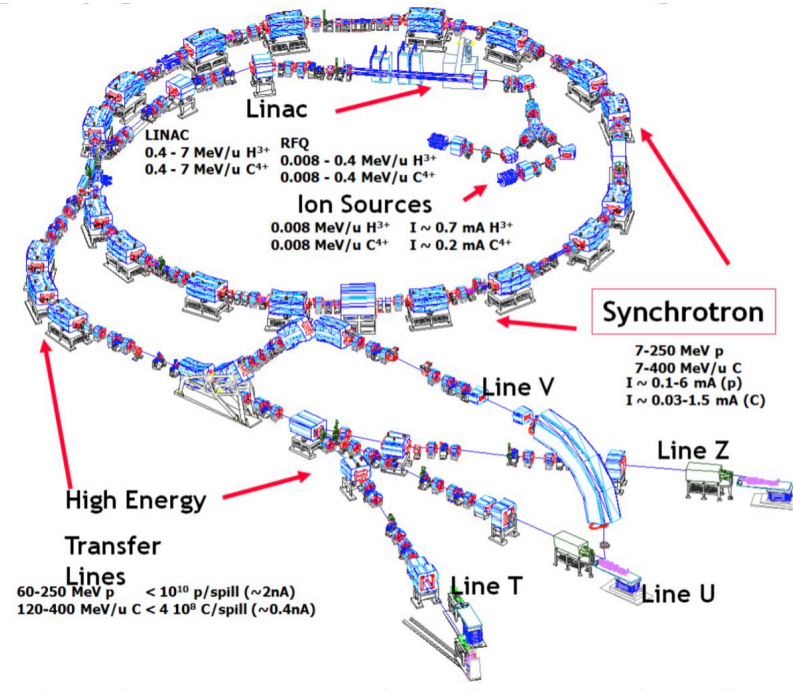
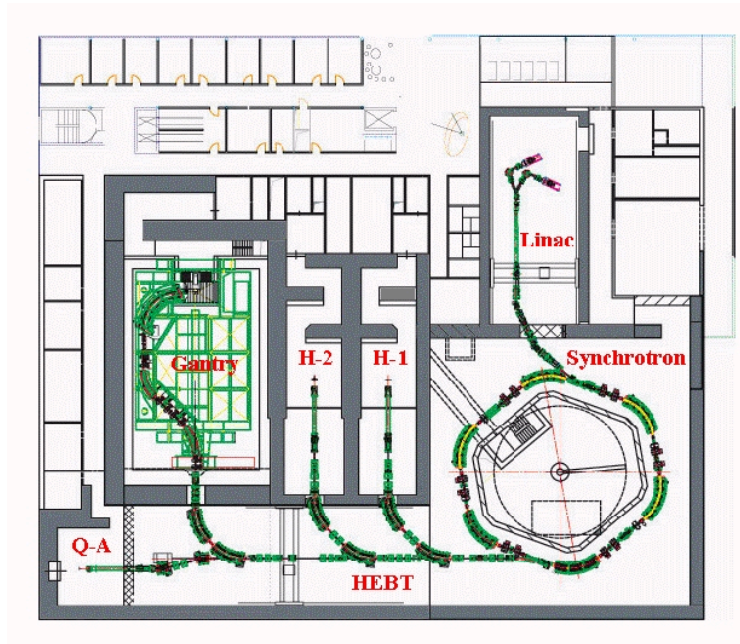



# HEBT layout

MedAustron and Marburg/Shanghai - space is not a major issue:

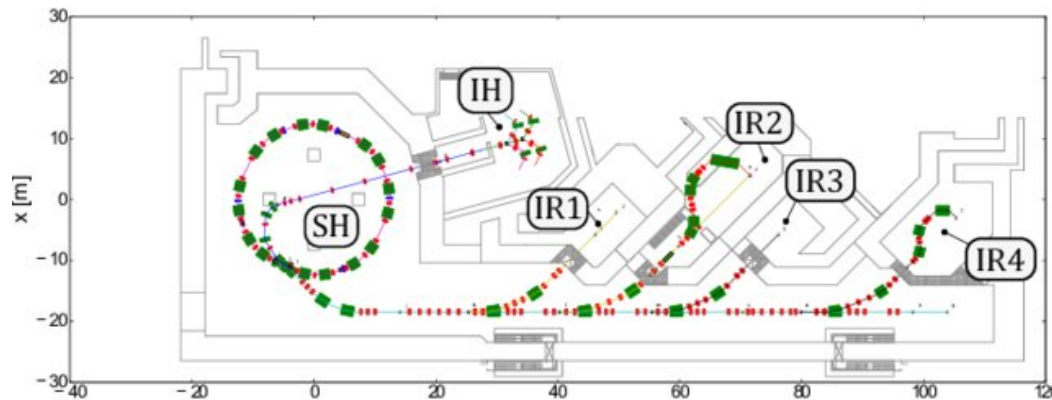

30-40% more surface

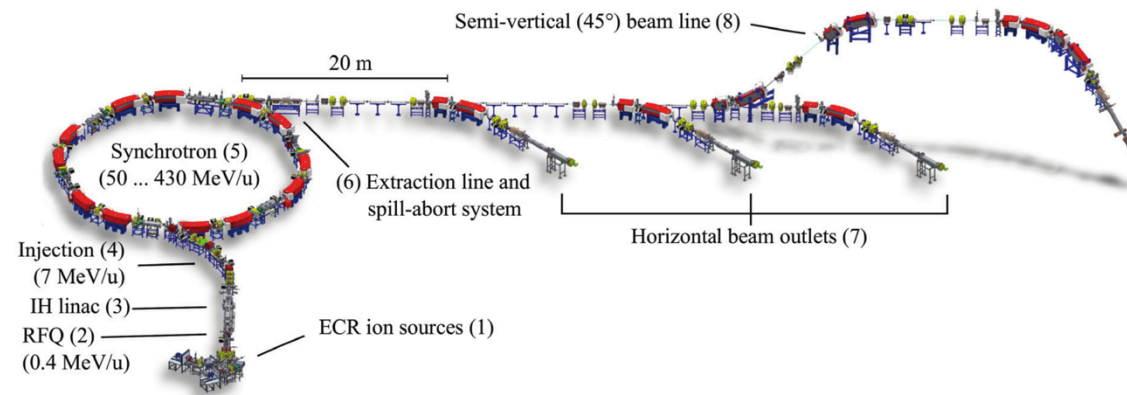



# Bar of charge

HEBT transports the beam and forms the beam spot on patient. The typical requirement for spot scanning irradiation techniques:

- beam spot size 4-10 mm
- zero dispersion and dispersion derivative, so particles with slightly different energy have the same trajectory and do not contribute to beam size
- beam divergence (Twiss alpha parameter) close to zero

Horizontal phase space of the beam has particular shape of *bar of charge*.

PIMMS project developed an elegant method of beam size control using rotation of the *bar of charge*, but it is implemented only in MedAustron. It requires more quadrupoles than standard approach

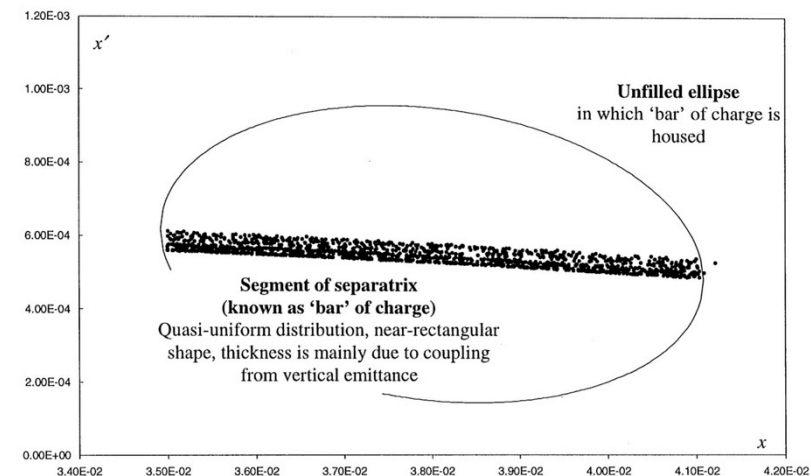

# HEBT – beam on patient

1. **Beam spot size** in horizontal plane:
  - *Bar of charge* shape is rotated to control beam size in MedAustron (phase-shifter-stepper)
  - Other centers work with shape of the ellipse keeping bar of charge horizontal
  - **Dispersion** on patient should be close to zero to avoid beam size increase
2. Beam spot size in vertical plane:
  - Standard regulation of the beam ellipse shape
3. **Beam divergence**:
  - Minimize to avoid beam spot size errors due to error on patient position

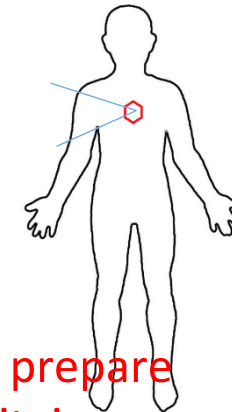
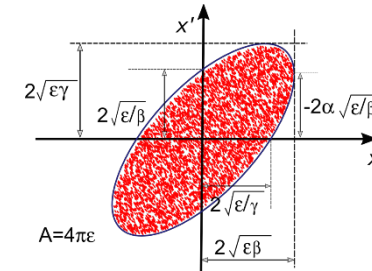
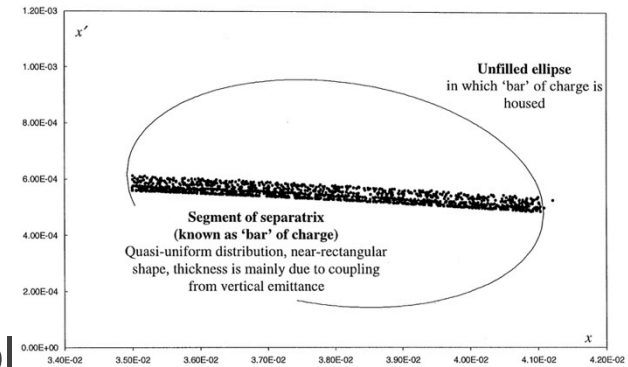

HEBT magnets prepare beam for irradiation

# NIMMS/SEEIIST HEBT layout

## Main considerations:

1. Green field approach
2. Spacious irradiation rooms
3. Large experimental area
4. Experiments separated from treatment
  - converting H/V lines to gantry
  - adding new beamlines

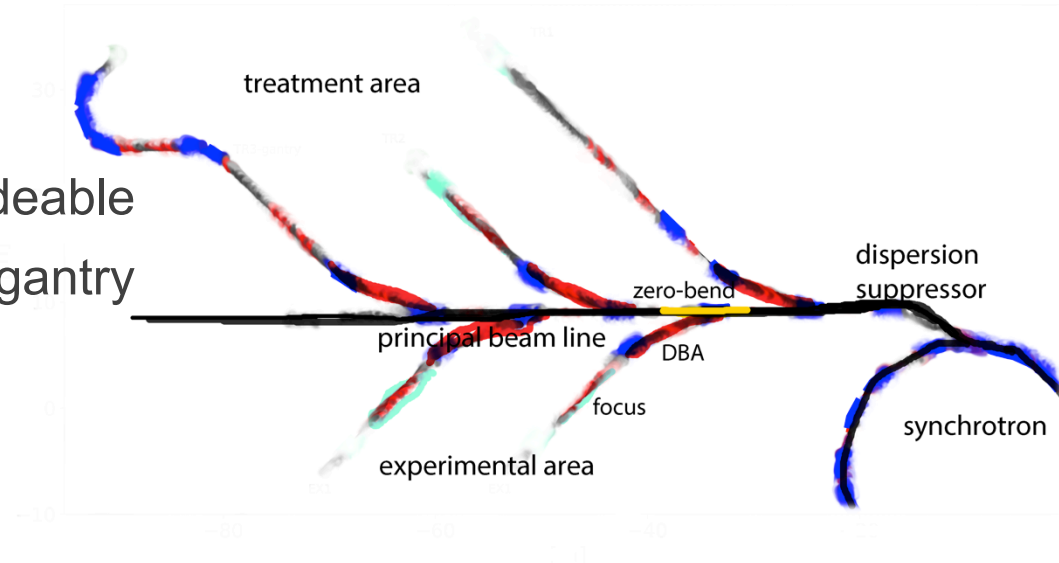

# HEBT - dispersion suppression

1. Beam comes out of synchrotron with a non-zero dispersion
2. Dispersion must be suppressed on the patient for therapeutical reasons
3. It is good to suppress dispersion right after extraction because:
  - beam transport along the principal beamline is easier as horizontal beam size is smaller
  - optics settings for beamlines to experiments and to treat
  - beam profile measurement more straightforward
  - construction of the beam cl

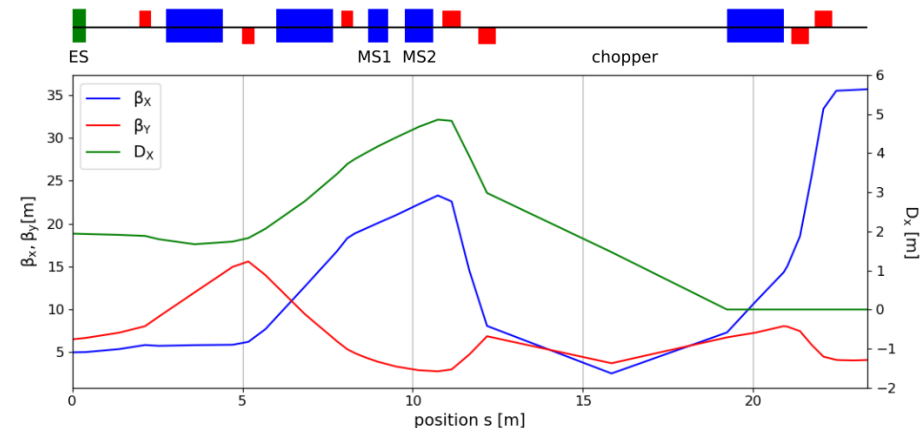



# HEBT beam chopper

1. Beam chopper is a safety device which allows to stop the spill withing 200 us.
2. It works as a chicane around an internal beam dump block
3. The beam must be small in the location of chopper to allow for fast stopping time
4. In current design of dispersion suppressor there is a large space for chopper
5. Double-chicane chopper could shorten beam stopping time by cutting the beam from both sides

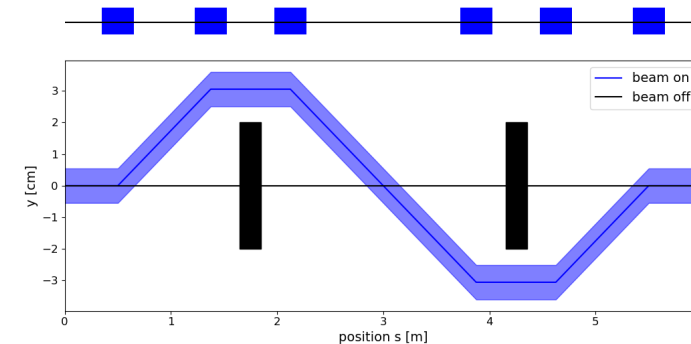
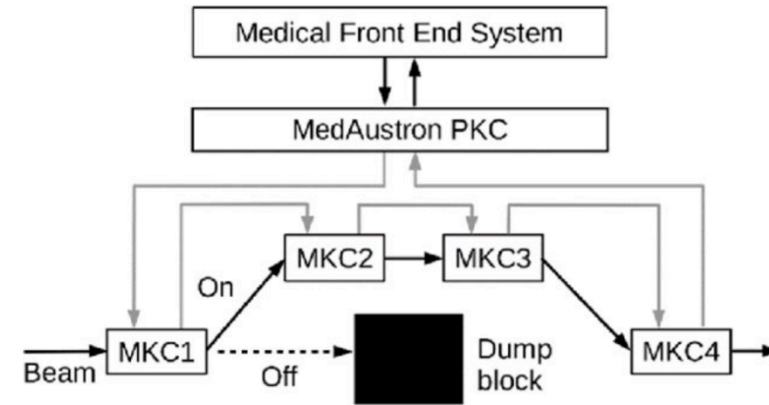

# HEBT – 3D scanning and FLASH

1. 3D pencil beam scanning is too slow for healthy tissue to benefit from FLASH effect
2. 2D scanning with 3D-printed special ridge filter is the main idea for FLASH

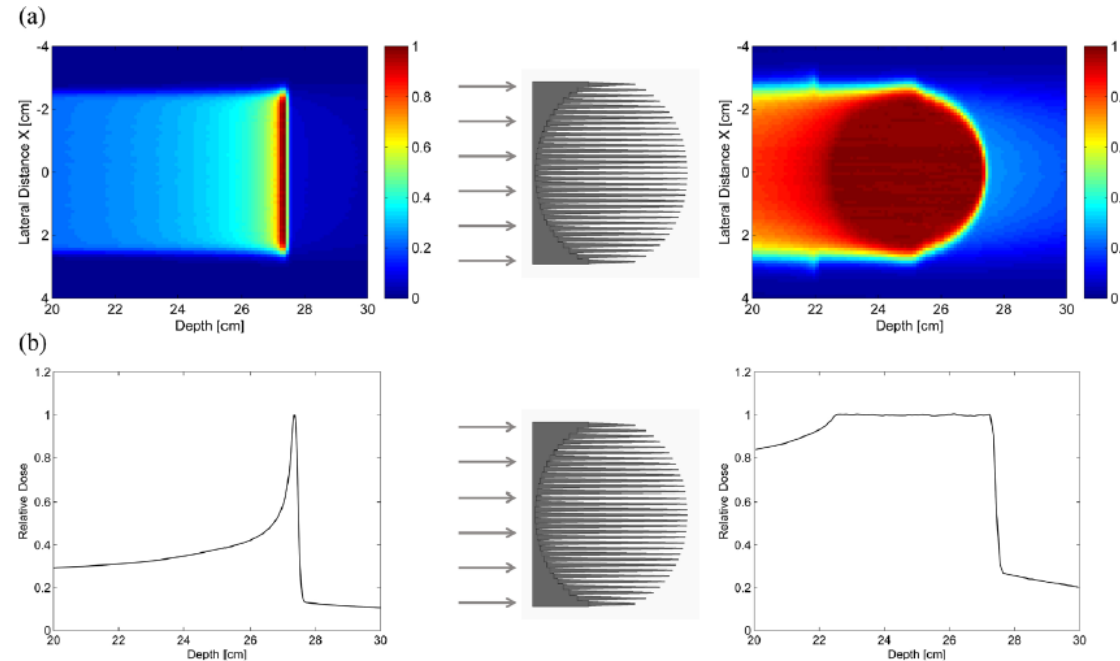

# HEBT - beam transport

Example of proposed beam transport (TR2): dispersion-suppressor, zero-bend sections, double-bend achromat and final focus with scanning magnets

**Double Bend Achromat (DBA)**

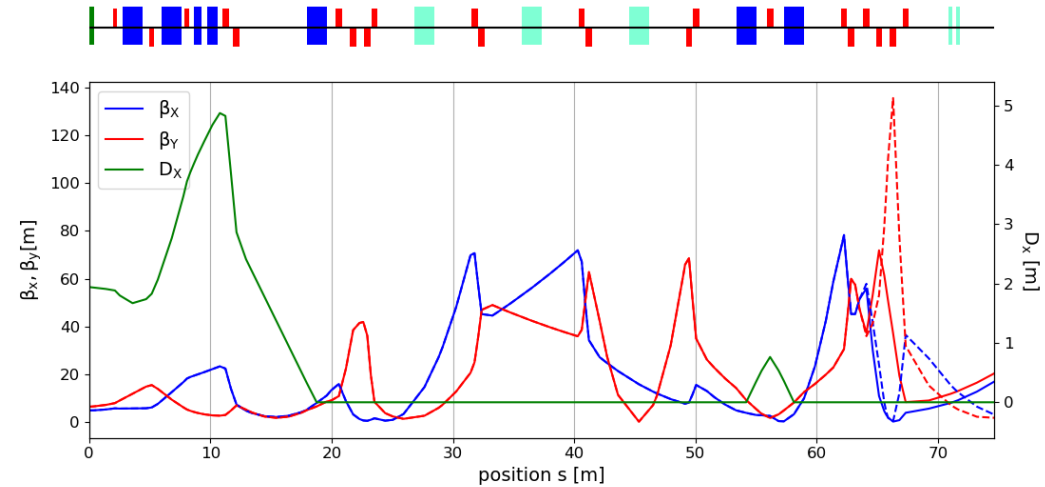
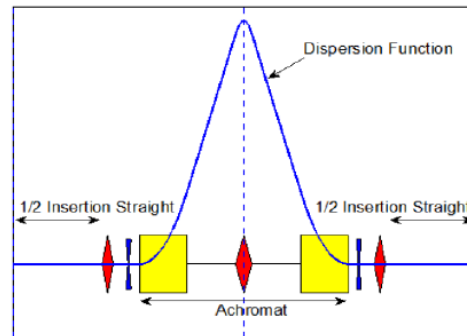

# HEBT layout

1. Three treatment rooms (H/V, H and gantry) and two main experimental rooms (with experimental space which can be reconfigured)
2. Typically 3-meter **shielding walls** required to reduce dose to environment below 1 mSv/year.

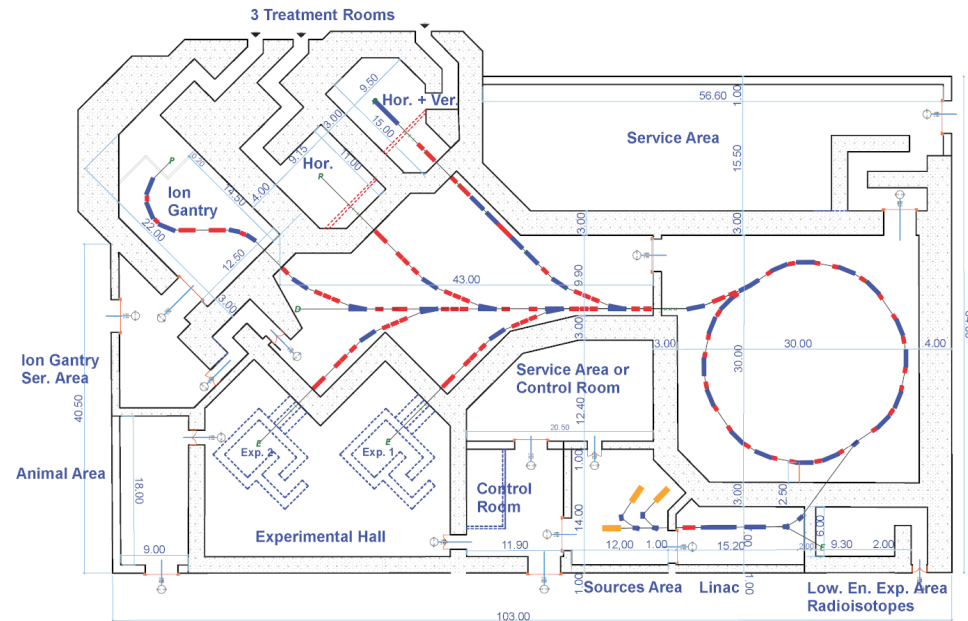
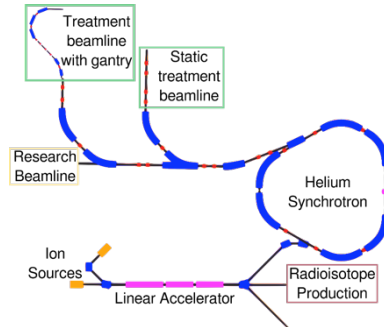

AREA: 6.500 M2



# Summary

1. Currently only synchrotrons are used in ion therapy, because of their **flexibility, variable energy and particle type**, and NIMMS design is based on synchrotron, but with many changes to legacy design
2. New, high intensity **ECR ion source** is being developed, necessary for carbon operation
3. New, **3-stage injector linac**, with new RFQ and high duty factor for **radioisotope production**
4. Warm synchrotron, based on PIMMS, with 20x higher beam intensities and advanced beam extraction scheme for **Multi-Energy Extraction and for FLASH**
5. Smaller **synchrotron for helium** therapy and superconducting machine
6. HEBT with **large experimental area**, fast(er) beam chopper, **various dose delivery modalities** (FLASH, 3D pencil beam scanning), large dynamic range of instrumentation, fast switching between beamlines
7. Superconducting **carbon gantry**, also for existing facilities



"This material was prepared and presented within the HITRIplus **Specialised Course on Heavy Ion Therapy Research**, and it is intended for personal educational purposes to help students; people interested in using any of the material for any other purposes (such as other lectures, courses etc.) are requested to please contact the authors

[Elena.Benedetto@cern.ch](mailto:Elena.Benedetto@cern.ch)

[Mariusz.Sapinski@psi.ch](mailto:Mariusz.Sapinski@psi.ch)