

## SuperKEKB

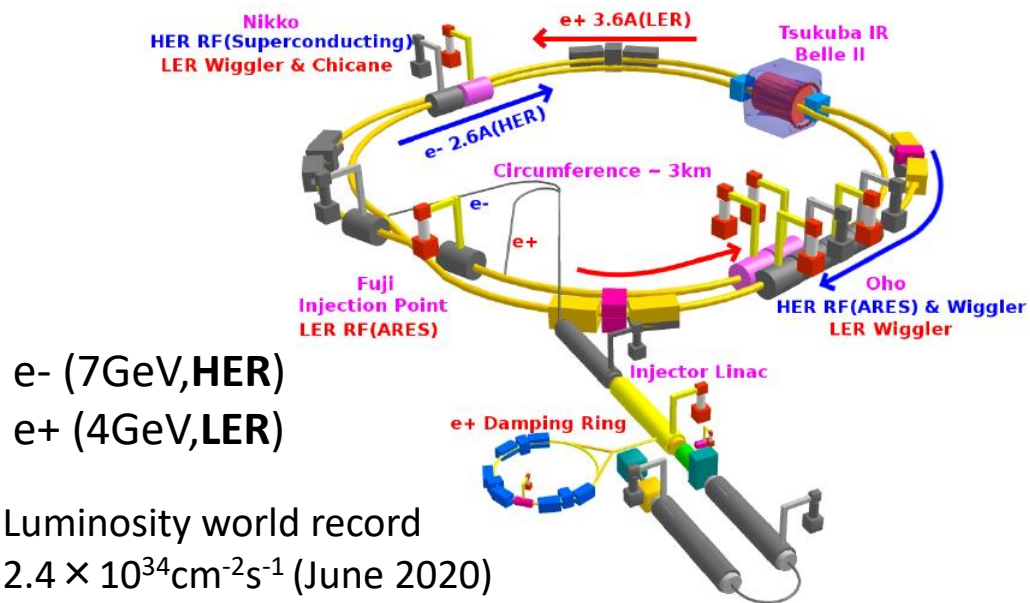

## Belle II

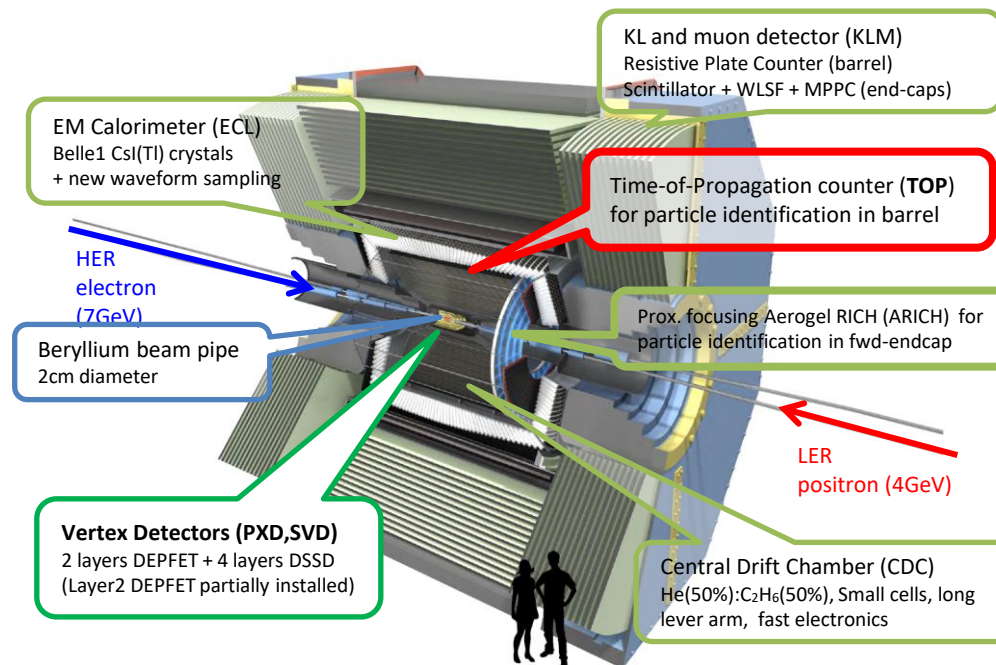

# Beam background and Machine-Detector Interface design at SuperKEKB/Belle-II



Hiroyuki Nakayama (KEK), on behalf of  
SuperKEKB/Belle II collaboration

hiroyuki.nakayama@kek.jp

# SuperKEKB accelerator

- 4GeV e+, 7GeV e-, 3km in circumference
- Nano-beam and Crab waist collision scheme
  - Design luminosity: aims to x40 higher than KEKB
  - x2 higher beam currents, x20 smaller vert. beta function ( $\beta^*y$ )
- Latest peak luminosity record:  $L=4.71 \times 10^{34} \text{cm}^{-2}\text{s}^{-1}$  (June 22, 2022)
- Now in “Long Shutdown (LS1)” for accelerator/detector upgrade works
- Beams will be back in October 2023

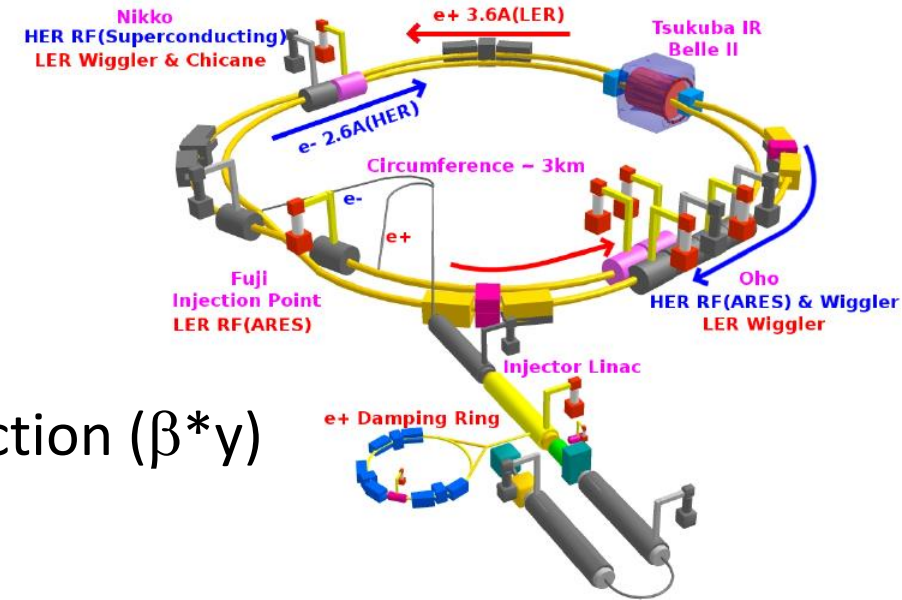

# Beam background at SuperKEKB

- Beam-induced background (beam BG) is dangerous for SuperKEKB/Belle II
- Beam BG determines survival time of Belle II sensor components and might lead to severe instantaneous damage
- It also increases sensor occupancy and irreducible analysis BG

- SuperKEKB Beam BG sources

- *Single-beam BG*: **Touschek**, **Beam-gas Coulomb**/Bremsstrahlung, Synchrotron radiation, **injection BG**

- **Luminosity BG**: Radiative Bhabha, two-photon BG, etc..

(Lumi-BG is now smaller than single-beam BGs, but will dominate at the full design current)

Touschek

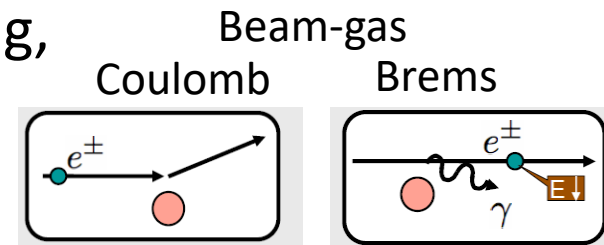
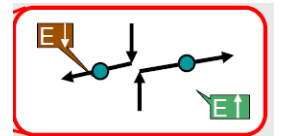

Rad. Bhabha:  $e^+e^- \rightarrow e^+e^-\gamma$

Two photon:  $e^+e^- \rightarrow e^+e^-e^+e^-$

# How to cope with beam BG?

- **Movable collimators** in the main ring
  - Cut beam tails/halos: stop stray particles before they reach the detector region
- **Thick tungsten shield** around the major beam loss spots near the detector
  - Showers generated in the final focus quads are stopped before entering Belle II region
  - Careful design of Machine-Detector Interface(MDI) region is a key

# SuperKEKB Collimators

e<sup>-</sup> (7GeV,HER)  
e<sup>+</sup> (4GeV,LER)

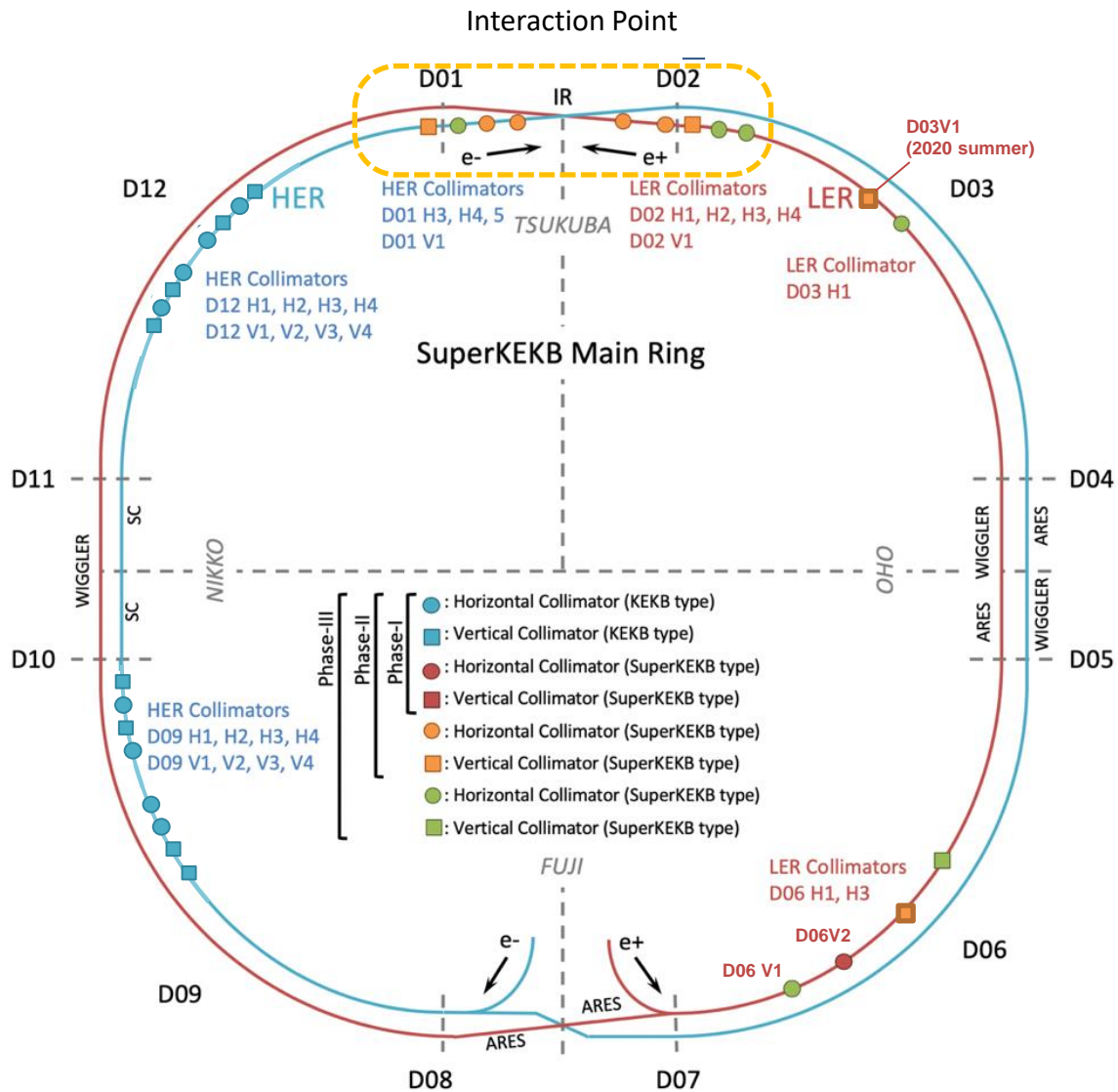

As of 2021,

31 movable collimators installed

## LER(11):

- 7 horizontal, 4 vertical “SuperKEKB type” collimators
  - horizontal: D06H1, D06H3, D03H1  
D02H1, D02H2, D02H3, D02H4
  - vertical: D06V1, D06V2, D03V1, D02V1

## HER(20):

- 3 horizontal, 1 vertical “SuperKEKB type” collimators
  - horizontal: D01H3, D01H4, D1H5
  - vertical: D01V1
- 8 horizontal, 8 vertical “KEKB type” collimators
  - horizontal: D12{H1,H2,H3,H4}, D09{H1,H2,H3,H4}
  - vertical: D12{V1, V2, V3, V4}, D09{V1,V2,V3,V4}

Horizontal collimators → Touschek BG  
Vertical collimators → Beam-gas Coulomb BG



# Vertical Collimators: very narrow

- To reduce beam-gas Coulomb IR loss, we need very narrow (<~2mm half width) vertical collimators
- **TMC instability is an issue**: low-impedance head design is important, and collimators should be installed at the position where beta<sub>y</sub> is rather small

(\*) "Small-Beta Collimation at SuperKEKB to Stop Beam-Gas Scattered Particles and to Avoid Transverse Mode Coupling Instability", H, Nakayama et al, *Conf.Proc.C 1205201* (2012) 1104-1106

- Precise head control ( $\Delta d \sim 50 \mu\text{m}$ ) is required, (IR loss is quite sensitive to the collimator width)
- Collimator head should survive severe beam loss  
→ Tungsten (or Tantalum) jaws were severely damaged and replaced several times. Low-Z head tip (carbon) was installed during 2020 autumn run but its impedance was found out to be too large (Beam size blow up due to TMC instability was observed)

SuperKEKB-type vertical collimator

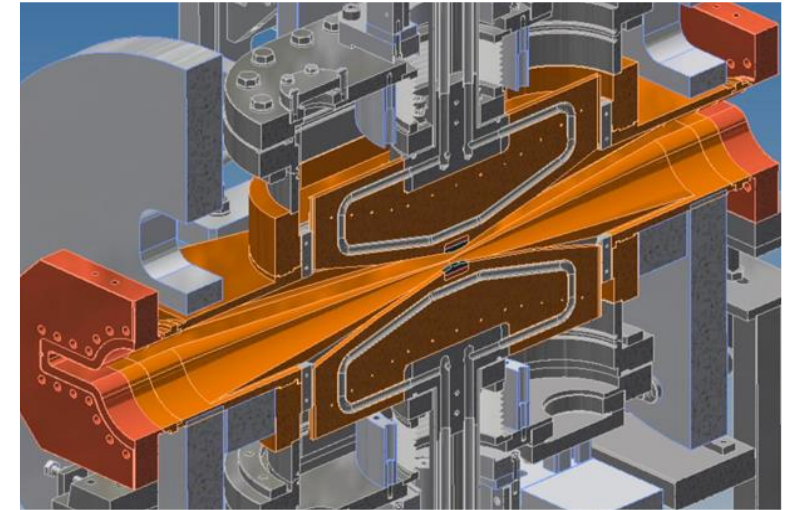

Collimator head damaged by severe beam loss

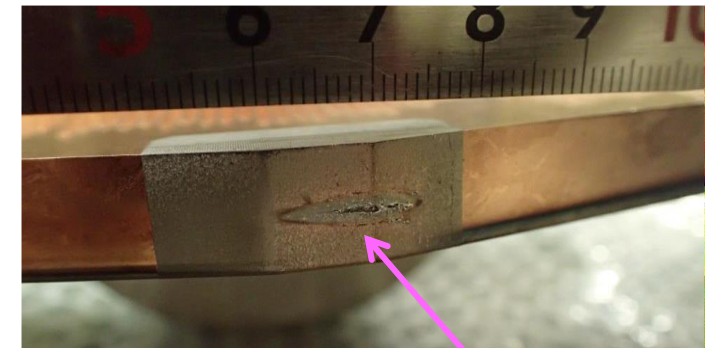

Scar along the beam line

# Background reduction history

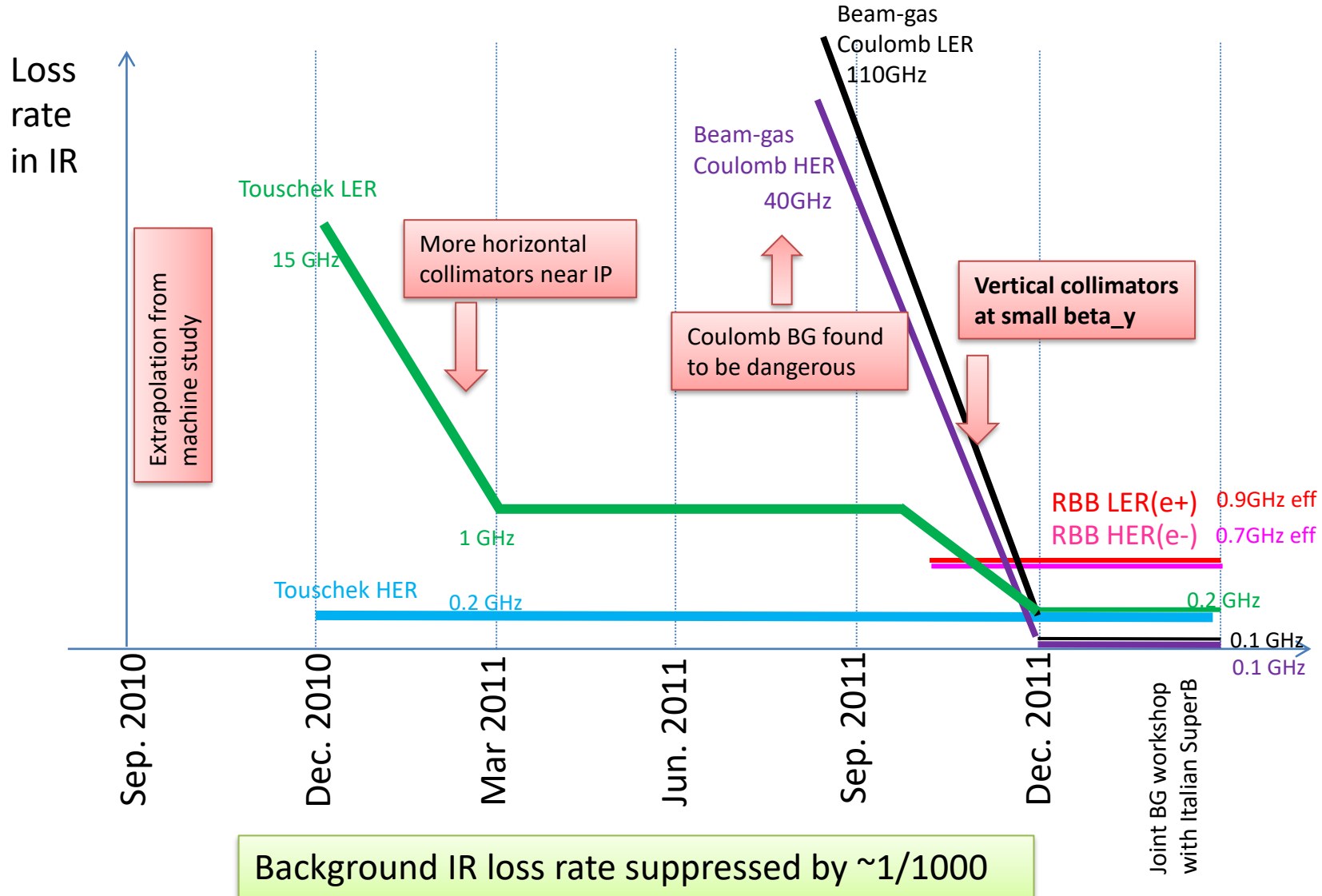

# QCS (final focusing magnet) cryostat design: in TDR(2010) and final(2016)

## TDR(2010)

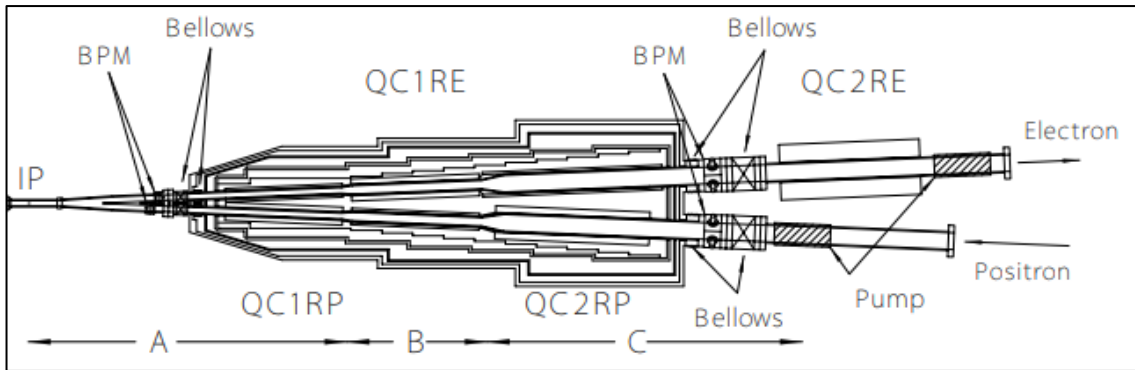

- TDR is prepared just after the change of SuperKEKB design concept (“High current ” → “Nano-beam”)
- At that time, no background estimation was available for the “Nano-beam” beam optics
- No shield considered inside the cryostat

## Final design

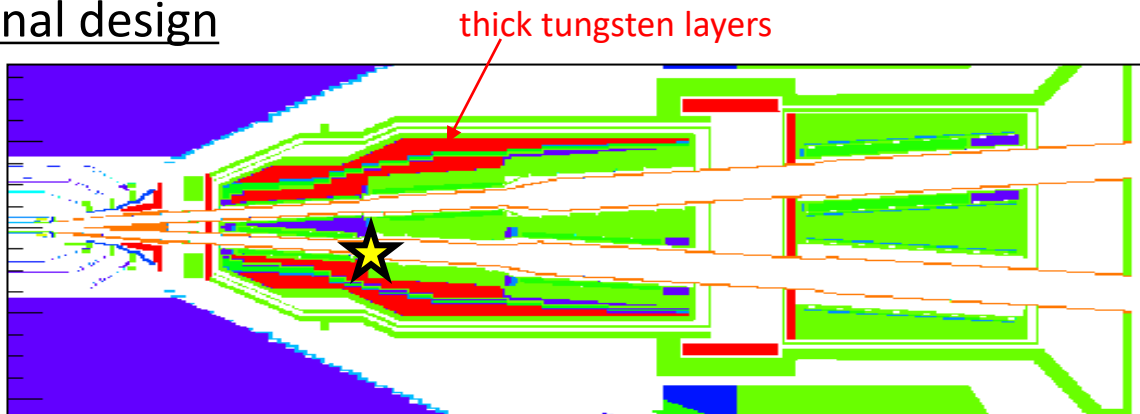





- As background simulation developed, we found a significant beam loss inside the final focus magnet
- We made a strong request to put as much heavy-metal shield as possible inside the QCS cryostat
- It was painful, since the mechanical design needed major modifications

Takeaway message: Reserve enough space for the BG shields between detectors and beam pipes!

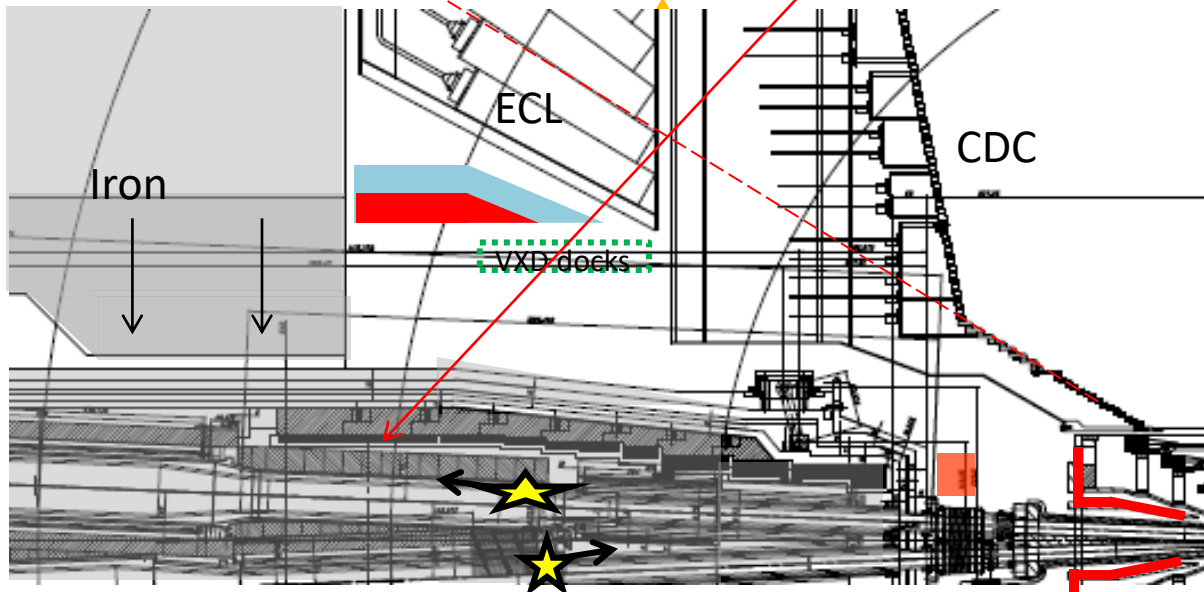
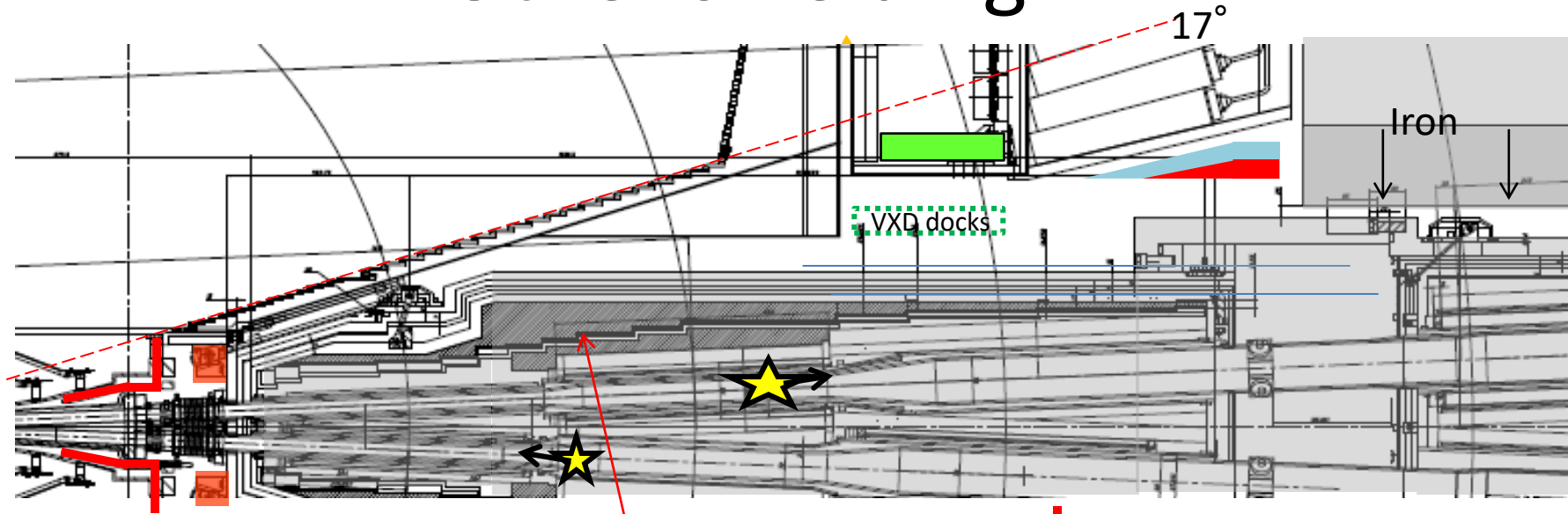

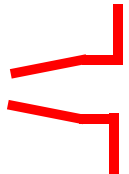
# Other shielding



-  Heavy metal shields to protect VXD from showers generated in cryostat
-  Neutron shield to protect HAPDs in ARICH (Boron-doped Polyethylene)
-  ECL shield, for included for (Lead + Polyethylene)
-  Remote Vacuum Connection structure in front of QCS reduces showers from RBB loss at  $|s| \sim 60\text{cm}$  (6cm-thick SUS)

# Background measurements

# Beam Background measured in 2020

- TOP counter is the Belle II sub-detector most vulnerable to beam backgrounds
  - Finite PMT photocathode lifetime, replacement work at the long shutdown needed
- LER beam-gas BG has reduced since 2019, but still the largest component
  - Vacuum scrubbing progress, tighter collimator settings, etc.

TOP background breakdown during recent physics runs

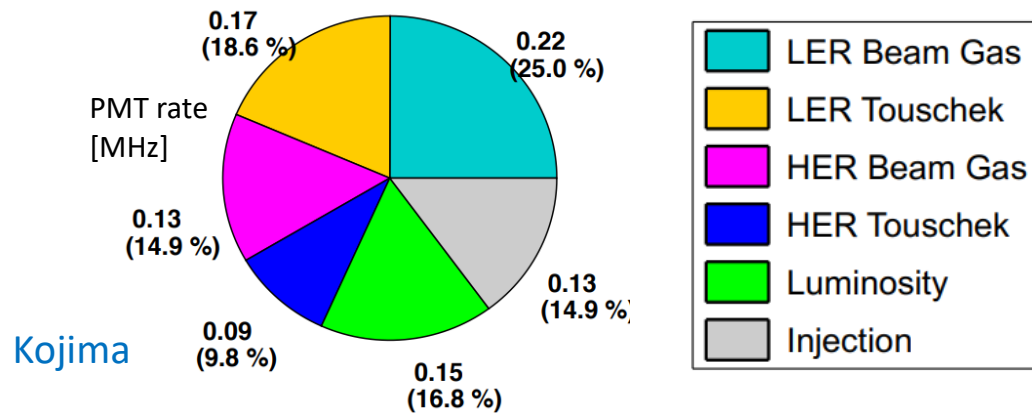

June 28, 2020  
beta\* $\gamma$  = 0.8mm

Input values to calculate background rate.

$$I^{\text{HER}} = 500 \text{ mA}$$

$$\sigma_y^{\text{HER}} = 34 \text{ } \mu\text{m}$$

$$N_b^{\text{HER}} = 978$$

$$I^{\text{LER}} = 480 \text{ mA}$$

$$\sigma_y^{\text{LER}} = 66 \text{ } \mu\text{m}$$

$$N_b^{\text{LER}} = 978$$

$$\mathcal{L} = 1.5 \times 10^{34} \text{ cm}^{-2}\text{s}^{-1}$$

e- (7GeV,HER)  
e+ (4GeV,LER)

# Single-beam BG study

for measuring Touschek and Beam-gas component separately

Touschek component also depends on bunch length  $\sigma_z$

$$Rate = T \frac{I^2}{\sigma_y n_b} + B Z_e^2 I P \quad \xrightarrow{P = P_0 + cI} \quad Rate/Z_e^2 I P = T \frac{I}{\sigma_y n_b P Z_e^2} + B$$

T, B: Touschek/Beam-gas coefficient  
 $\sigma_y$ : vertical beam size,  $n_b$ : number of bunches  
 P: pressure, I: beam current  
 $Z_e$ : effective atomic number of residual gas

## Strategy:

- Single-beam (no collision). Assume Touschek + Beam-gas and no other BG component
- Vary number of bunches (or beam size), which should affect Touschek component only
- Fit for T and B coefficients and compare them against estimation by MC
- Use measured data/MC ratio for correcting the simulated BG rates at future optics
- Lumi-BG can also be measured as “total BG at collision runs” – “sum of single-beam BGs”

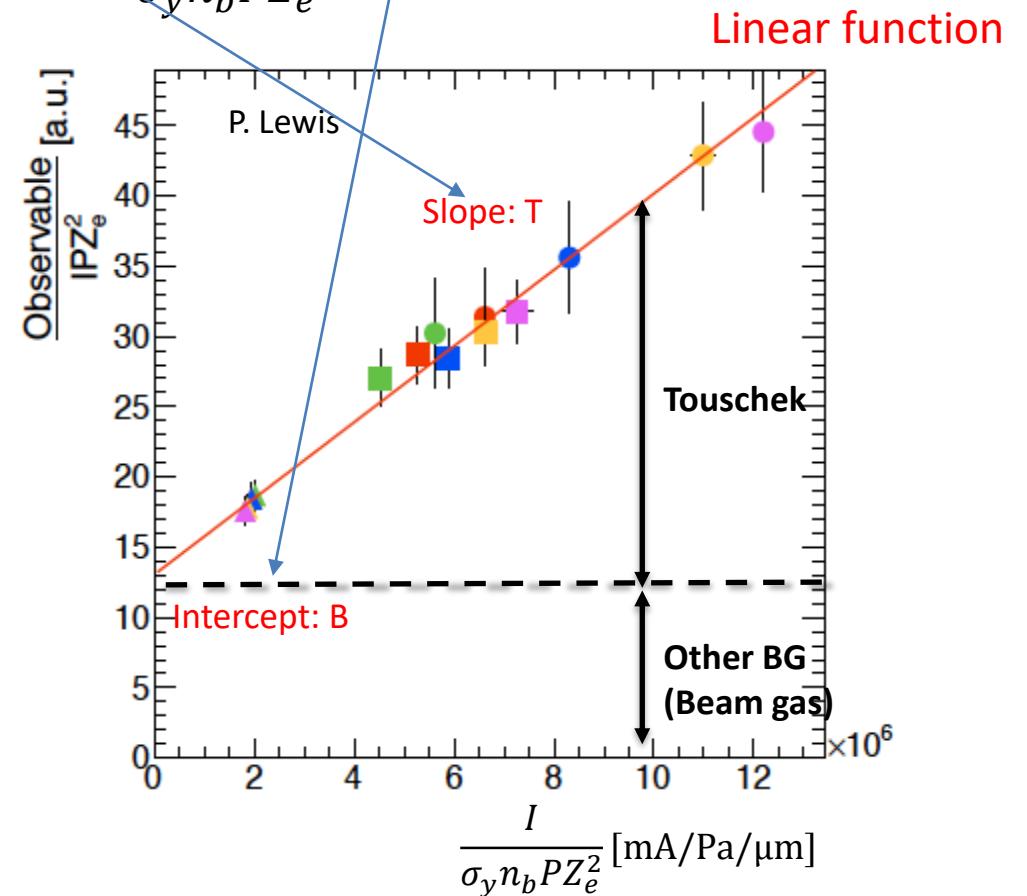

# Data/MC ratio

Ratios of measured (**data**) to simulated (**MC**) backgrounds based on dedicated studies in 2020-2021

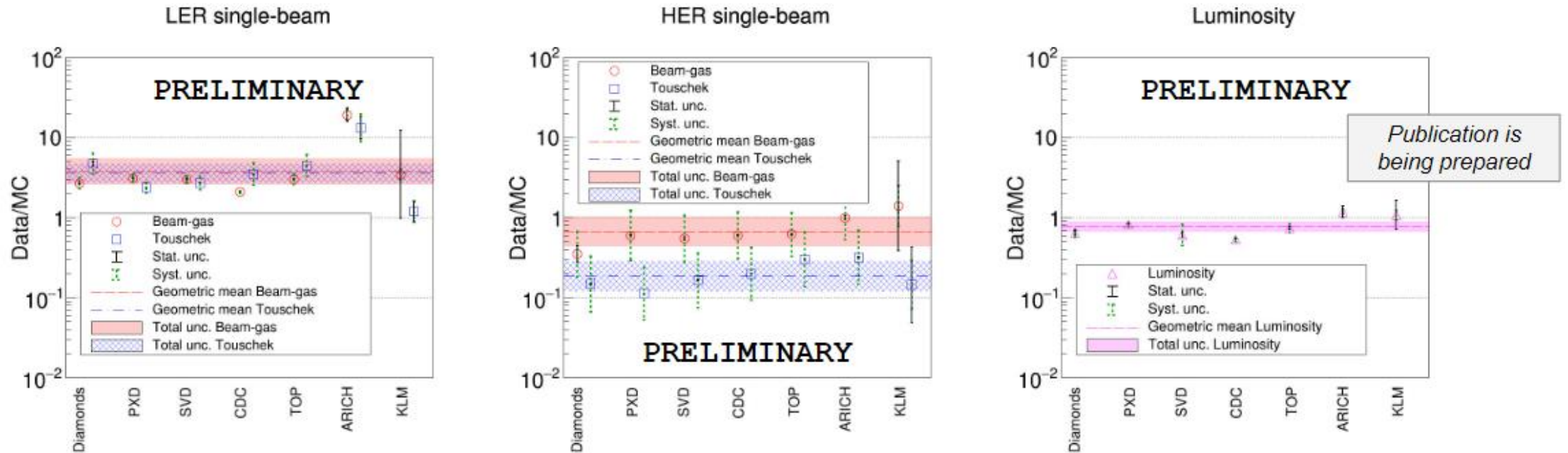

- Data/MC ratio is now within one order of magnitude from unity
- Measured lumi-BG stays consistent with prediction (will dominate at full luminosity)
- This confirms **our good understandings** on beam loss processes at SuperKEKB
- Those ratios are used to rescale simulated beam background rates toward higher luminosity

# Issues: Injection BG duration

- Belle II DAQ apply **trigger veto** after each injection, since the injected bunch gets noisy for a while
- Typical duration of injection BG → LER: ~10ms, HER: ~5ms
  - Corresponds to 5~10% downtime
  - longer veto window → lose integrated luminosity
- Dedicated machine studies are conducted in 2020
  - Single beam: BG duration  $\propto$  bunch current
  - Colliding beams: BG duration longer than single-beam
    - *beam-beam effect?*
  - Not only the injected bunch, but also later bunches are lost. However, “blank-shot” injections don’t give any BG duration
    - *Coupling btw. injected bunch and later bunches?*
    - Delayed arrival of neutrons generated at upstream collimators?*
  - Simulation effort to reproduce these behaviors is ongoing

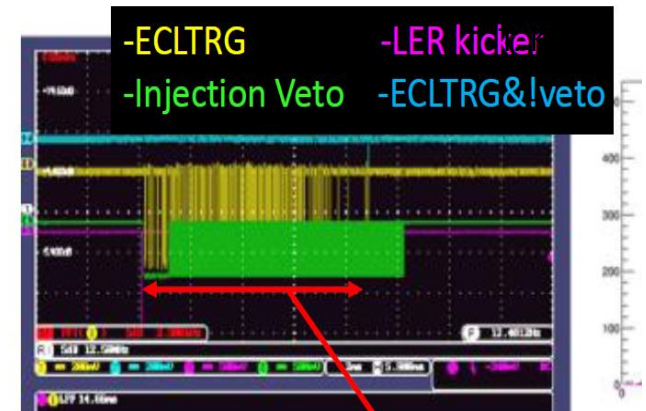

“Injection BG duration”

Injection veto window

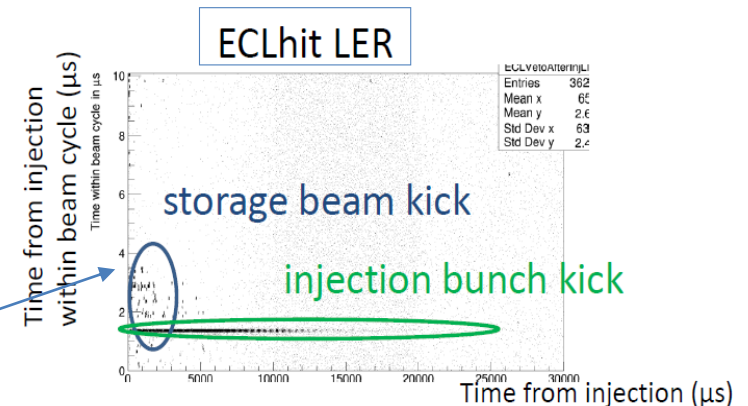
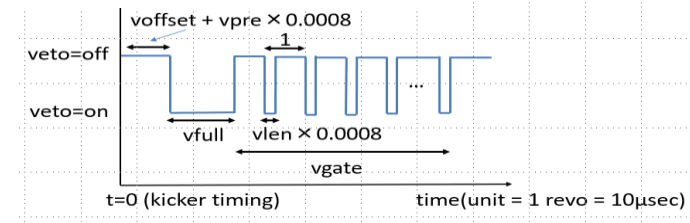

“blank-shot” injection: kickers are fired but no charge is injected



# Issues: Sudden Beam Loss (SBL) Events

- Sudden beam loss (SBL) events
  - Very fast beam loss within few turns (= 20~30us)
  - Lead to QCS quench, sensor/collimator damage
  - Operation time loss by collimator replacement work
  - Set limit on max. beam currents for physics runs
- The cause of these events is still unknown
  - Beam-dust event? Beam instability? Arcing?
  - Detailed analysis ongoing, using beam loss timing recorded by various beam loss monitors along the ring
  - International taskforce is launched to investigate the issue

Bunch current monitor

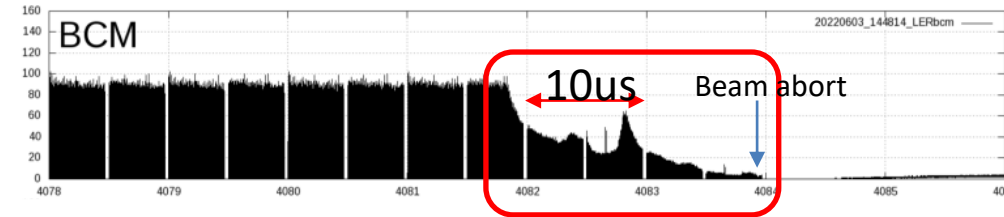

>80% of stored beam lost within ~20us



Collimator head damage due to SBLs

Beam loss monitors along the main ring

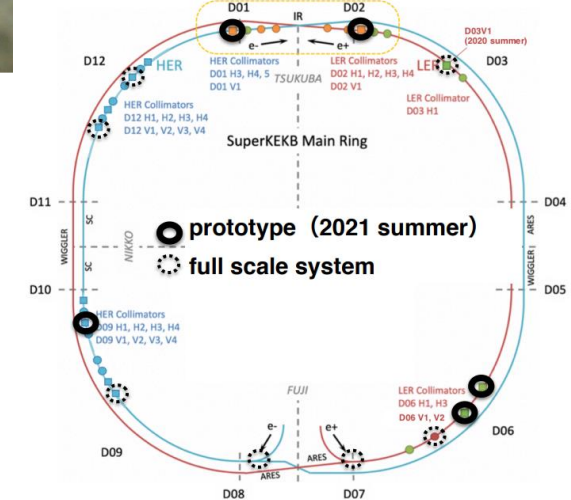

# Beam BG at the design luminosity

# Beam BG extrapolation toward future

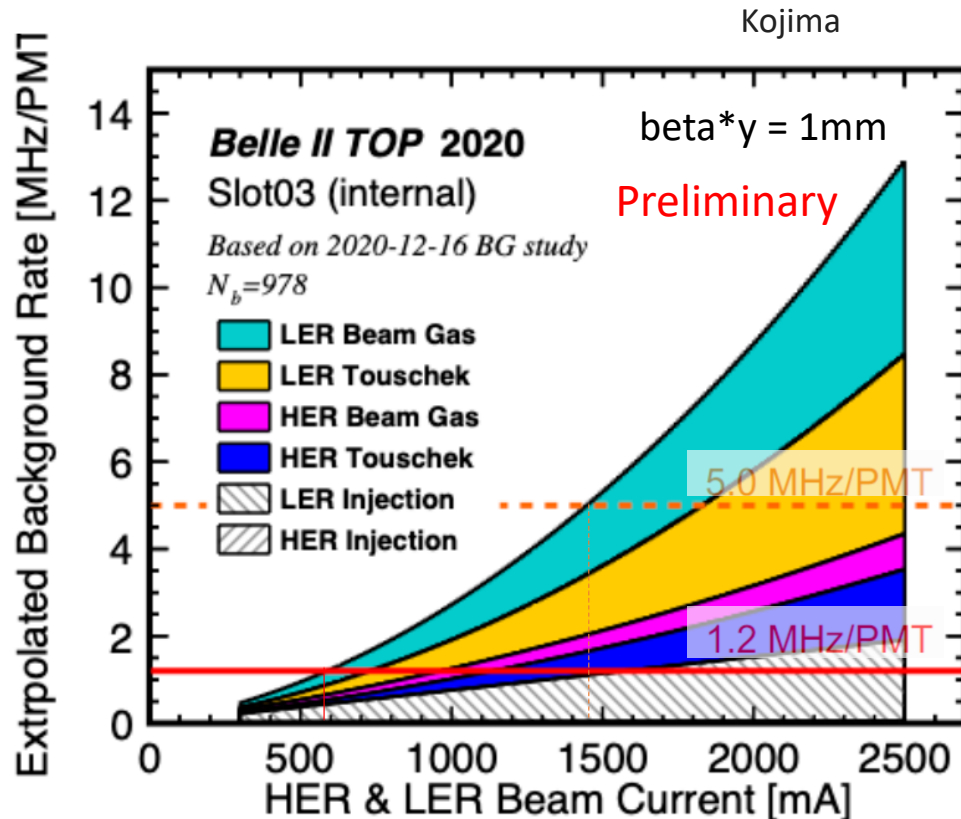

- Naïve extrapolation, no BG mitigation assumed (beam-gas should decrease as vacuum baking goes)
- Luminosity-BG component not shown here

- TOP PMT rate will increase as we accumulate more beam current to reach higher luminosity
- Since 2021, we relax the PMT rate limit from 1.2MHz to 3MHz, until the PMT replacement work during Long Shutdown (LS1) in 2022-2023
- After LS1, we might relax the limit to 5MHz, if we replace PMT once again in LS2 (2026?).
- Even with 5MHz limit, reachable current ( $\sim 1.5\text{A}$ ) will be smaller than the design current(2.6A) without background mitigation.

**NEED FURTHER MITIGATION!**

(see next page for possible mitigation ideas)

# Further BG mitigation possibilities

- Vacuum scrubbing
  - beam-gas background will be gradually improved as baking proceeds
- Collimators
  - Optimize collimators as  $\beta^*y$  becomes smaller (add new ones and/or move current ones to different places in the ring)
  - As injection gets more stable and cleaner, we can further squeeze collimators to reduce storage BG
  - However, TMC instability might be our bottleneck to add/squeeze collimator
- Additional shield around QCS bellows (2022-2023)
  - Cover the bellows pipe area where BG showers leak out
  - Only small space left for the shield (mostly occupied by sensor cables)
  - Further BG reduction for TOP/CDC
- Final focus magnet modification (2026 or later?)
  - Less overlap of solenoid and quads  $\rightarrow$  suppress beam-beam blowup
  - Wider beam pipe aperture  $\rightarrow$  less beam loss, relax collimator impedance

Additional shield around QCS bellows

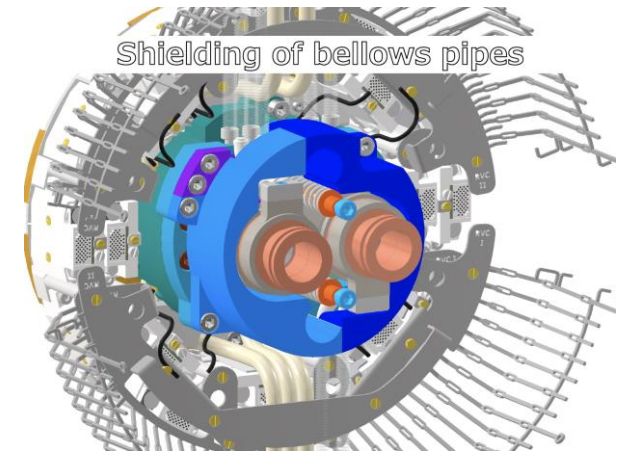

Final focus magnet modification

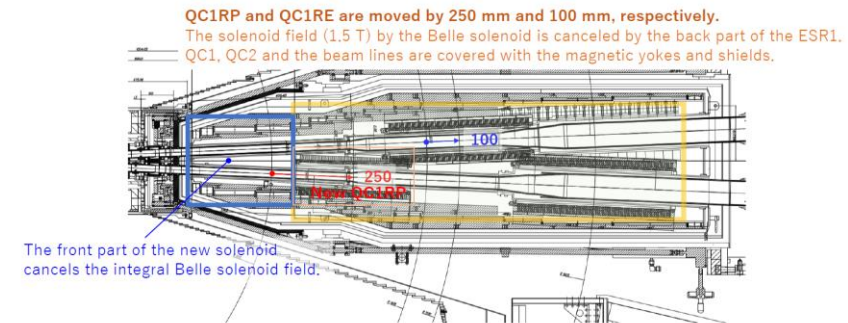

# Overall summary

- Beam background at SuperKEKB can be dangerous and various countermeasures have been applied
- BG simulation predicts the impact on Belle II sensors
- Dedicated machine studies can measure each BG sources separately and can provide scaling factors between data and MC, which can be used for future extrapolation
- We need further mitigations to cope with beam background at the full design luminosity

# Want to know more?

If you need further information on SuperKEKB beam background, you can also refer to our recent talk at “eefact 2022 workshop”, given by Andrii Natochii (Hawaii Univ.)

<https://agenda.infn.it/event/21199/sessions/22793/#20220913>



backup

# Where's "TOP" in Belle II Detector

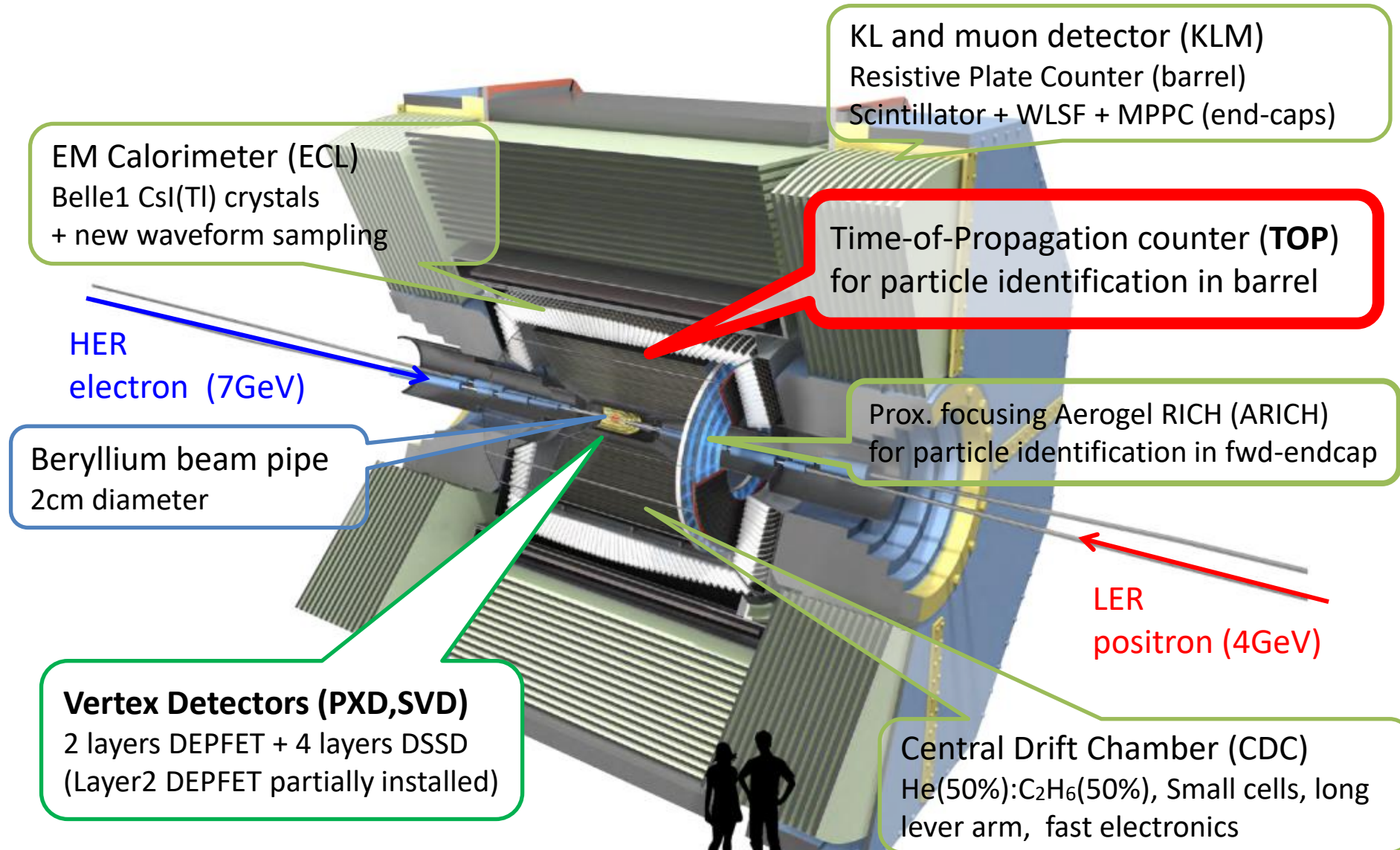

# MDI design

# Interaction region

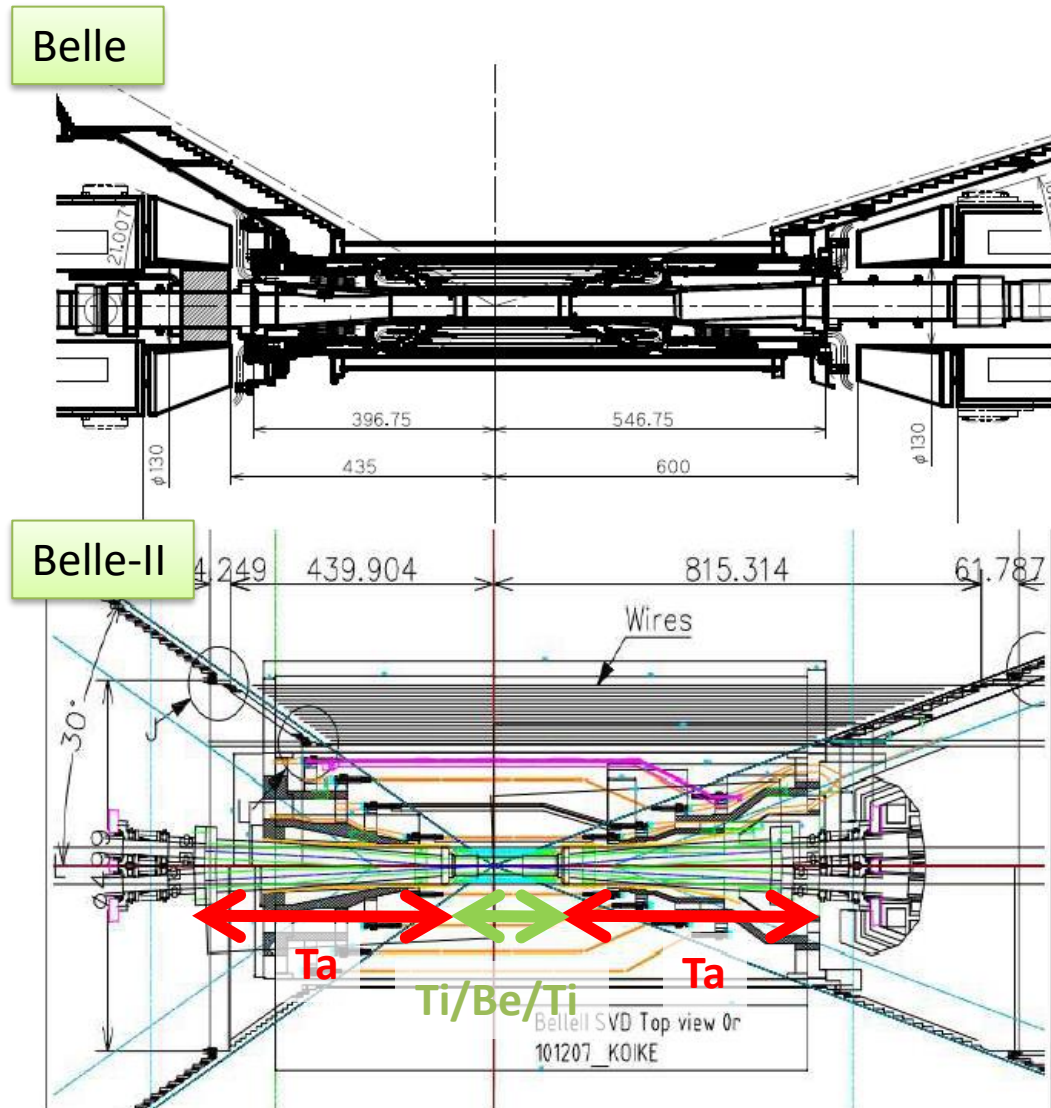

## <Belle-II>

- Smaller IP beam pipe radius ( $r=15\text{mm}\Rightarrow 10\text{mm}$ )
- Wider beam crossing angle ( $22\text{mrad}\Rightarrow 83\text{mrad}$ )
- Crotch part: Ta pipe
- Pipe crotch starts from closer to IP, complicated structure
- New detector: PXD (more cables should go out)



# Dedicated IP beam pipe design to mitigate synchrotron radiation BG

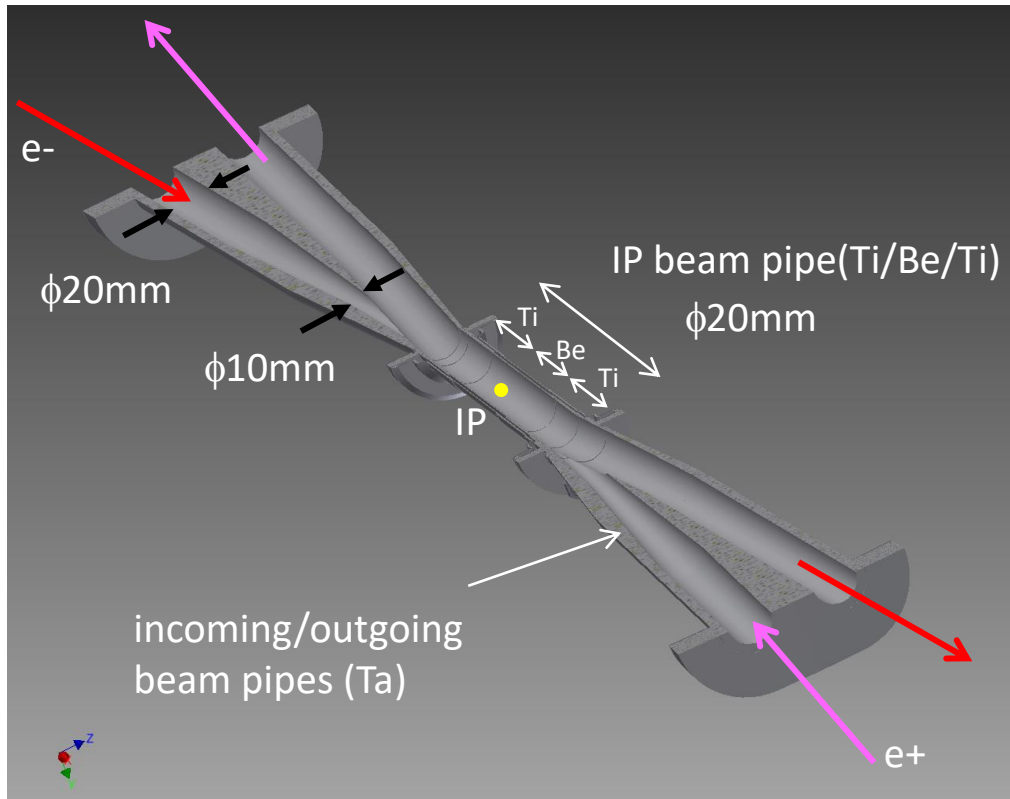

- Belle II IP beam pipes are specially designed to mitigate SR background
- **Collimation on incoming beam pipe** ( $\phi 20\text{mm} \rightarrow \phi 10\text{mm}$ ) stops most of SR photons in parallel with the beam
  - Direct SR hit on Be part of IP beam pipe is negligible
  - No collimation on outgoing pipes so that HOM can escape
- **“Ridge” structures** on inner surface of the collimation pipe can prevent forward-scattering of SR photons
  - One-bounce SR hit on Be part can also be negligible

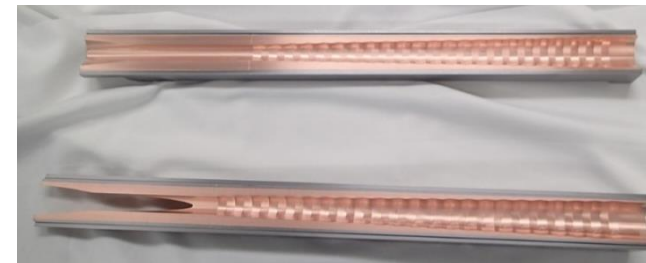

Ridge structure

Inner surface of Be pipe are coated with Au layer (10um)



# Background Global picture

Ver. 2017.1.31

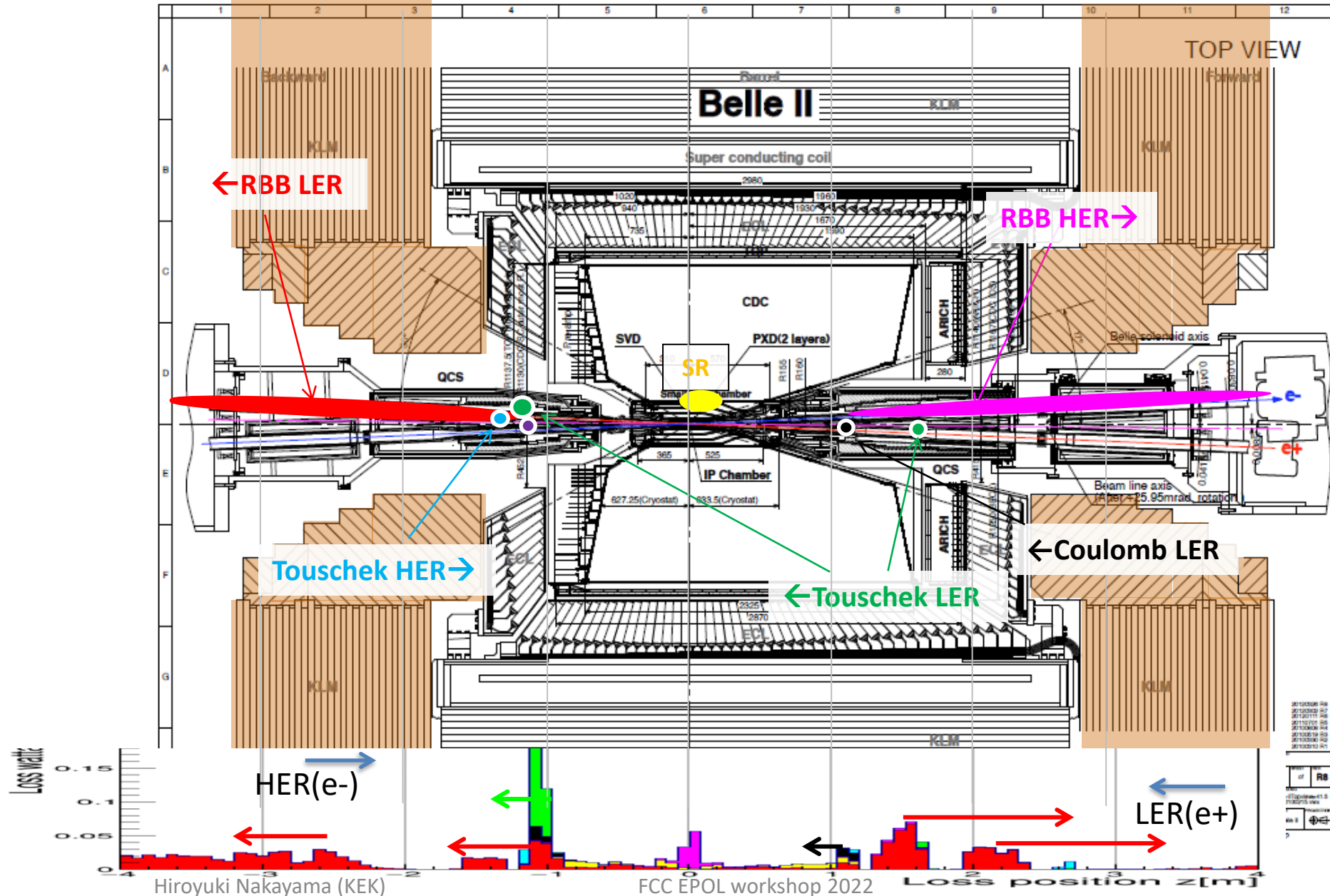

# Background simulation tools

- Use SAD for multi-turn tracking in the entire rings
  - **collimator tip-scattering**: recently implemented by Andrii Natochii
- Use GEANT4 for single-turn tracking within detector and full simulation

BG type	BG generator	Tracking	Detector full simulation
Touschek/Beam-gas	Theoretical formulae [1]	SAD [2] (up to ~1000 turns)	GEANT4
Radiative Bhabha	BBBREM/BHWIDE	GEANT4 (multi-turn loss is small)	GEANT4
2-photon	AAFH	GEANT4 (multi-turn loss is small)	GEANT4
Synchrotron radiation	Physics model in GEANT4 (SynRad)	GEANT4	GEANT4

[1] Y. Ohnishi et al., PTEP **2013**, 03A011 (2013).

[2] SAD is a “Home-brew” tracking code by KEKB group, <http://acc-physics.kek.jp/SAD/>

# BG measurement in 2020

# A snapshot from a single-beam BG study

Example: LER/HER single-beam study on May 9<sup>th</sup>, 2020

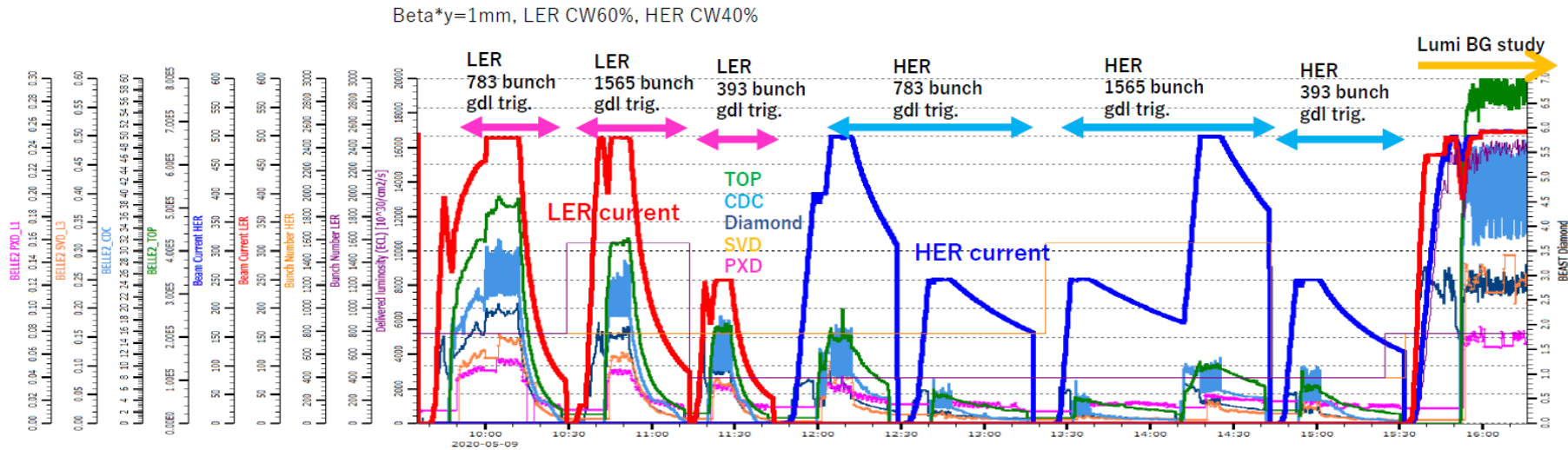

- Number of bunches: Nb=783/1565/393.
- As we increase number of bunches, Belle II BG rates at the same beam current becomes smaller (due to decrease in Touschek BG)
- Beam size scan is not used recently, since unexpected BG increase was observed at larger beam size.
- Observed dependency are consistent with the “Touschek+ Beam-gas” model (no significant indication of other BG sources)

# A snapshot from a Lumi-BG study

Beta\*y=1mm, LER CW60%, HER CW40%

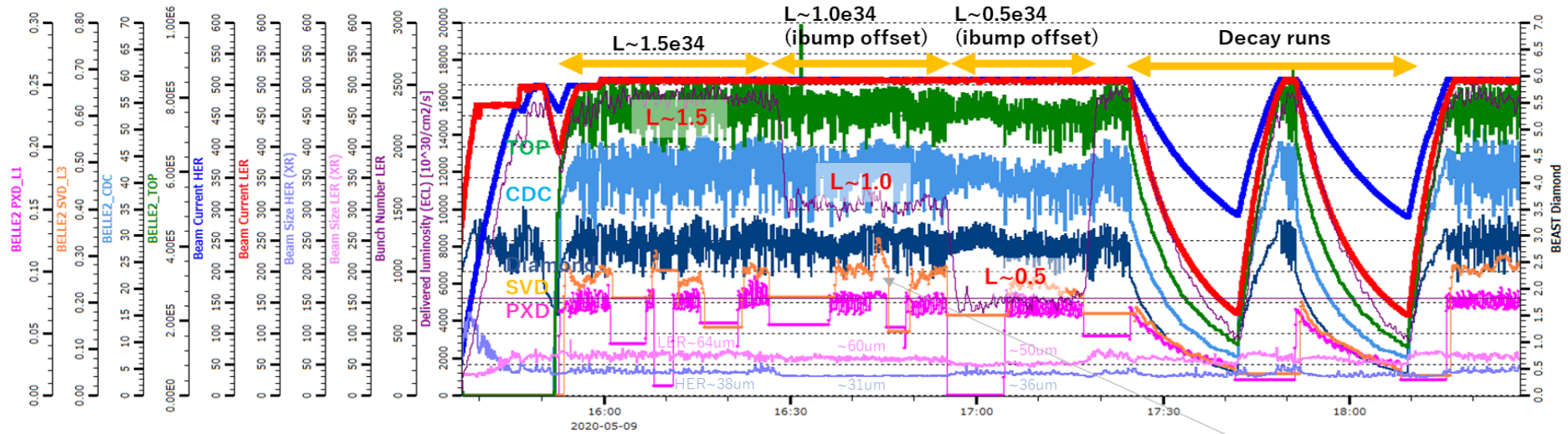

- “Continuous injection” runs
  - $L=1.5 \rightarrow 1.0 \rightarrow 0.5e34$ , by vertically displacing two beams (“ibump V-offset”)
  - Beam sizes slightly changes as luminosity changes
- “Beam decay” runs (no injections)
  - Measurement not affected by injection BG
- Measure lumi-BG component by subtracting single-beam BG components scaled with current, beam size, etc..
- Measured Lumi-BG agrees with simulation at the ~10% level in TOP, PXD !!
  - Also agrees between “continuous injection” and “beam decay” data

# Issues: PXD SR during HER injection

Carsten

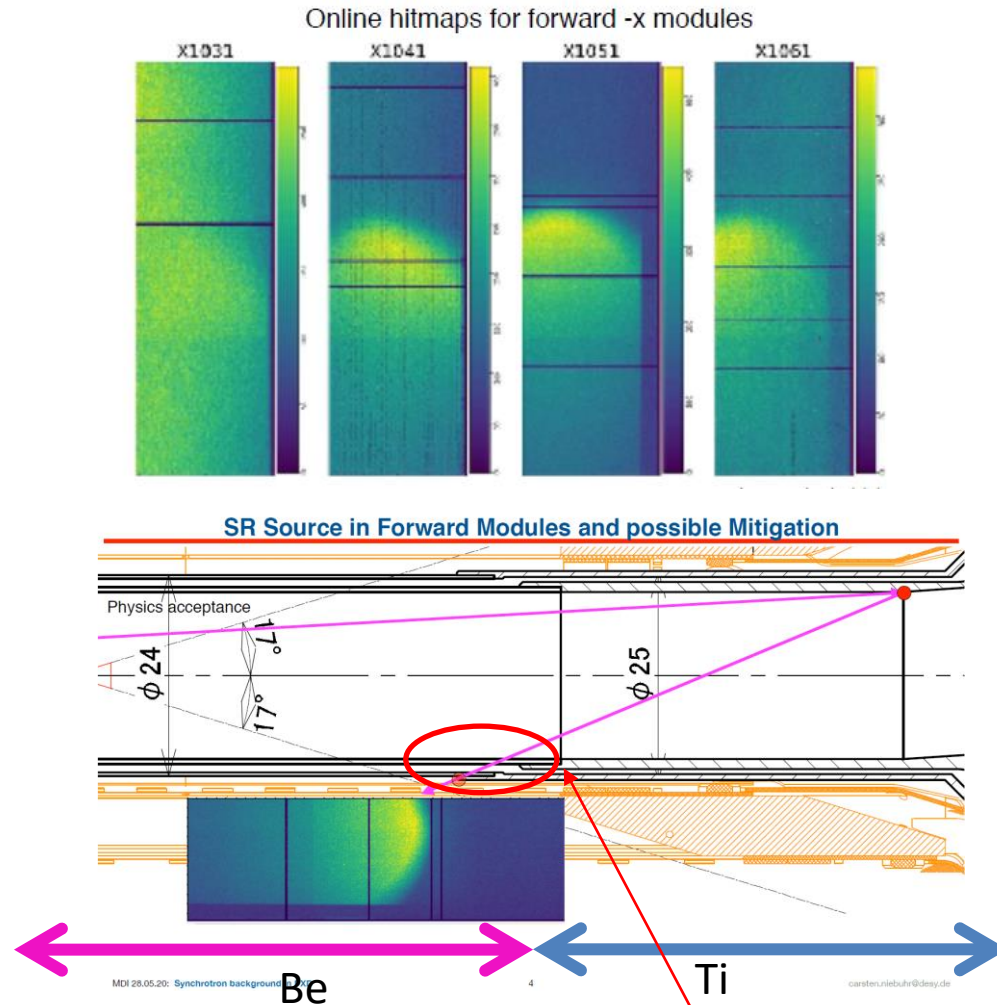

- SR hit pattern on PXD forward -X modules
- Became stronger when HER beta\*\_x was squeezed
- **Only visible during HER injection**
  - not observed with “blank-shot” HER injections
- HER horizontal tune adjustment shows no significant improvement within acceptable tune range
- HER D01H collimator adjustment didn't improve SR

PXD SR is not critical right now, but we need to keep our eyes on it.

We plan to add gold layer here for the new beam pipe (2022)



# Recent improvements to simulation

A. Natochii

- **Andrii Natochii** implemented an improved framework for beam-particle tracking in SuperKEKB
  - New features: apply collimation after particle tracking, pressure-weighted beam-gas simulation, custom beam pipe aperture shapes, etc..
- Largest impact: implementation of **correct SuperKEKB collimator shape + tip scattering**
  - Particles previously stopped by the collimators can now reach the IP
- **Up to factor 1000(!) increase in simulated Belle II detector rates, resolving a longstanding HER data/MC discrepancy**
- **Surprisingly, largest effect from collimator shape change transverse to beam axis**
  - This may imply we could benefit from wider collimator heads for HER D1V1, in plane transverse to beam  $\rightarrow$  should be studied (kick factor, etc.)

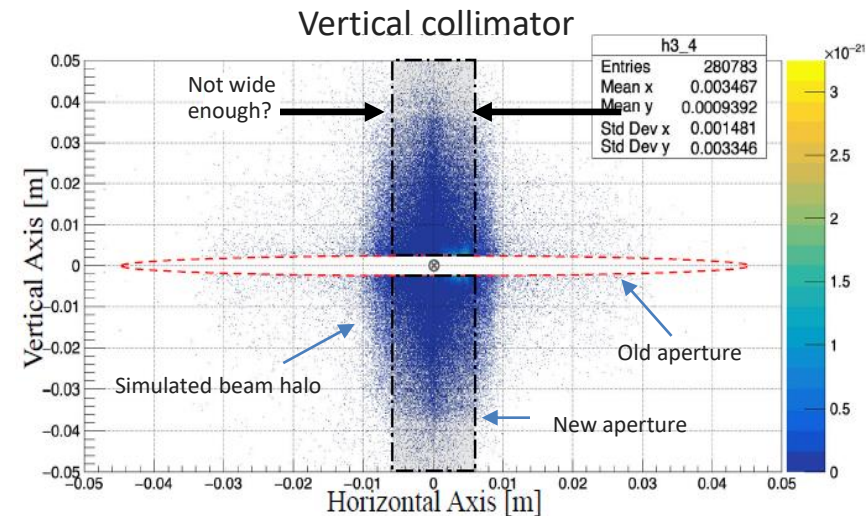
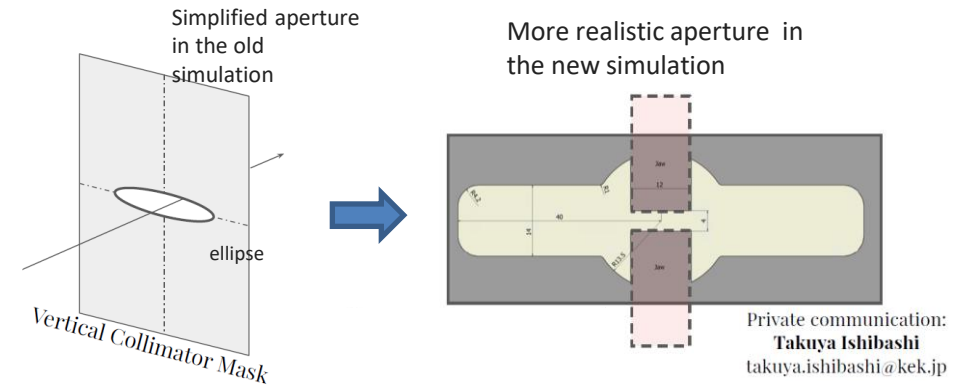

# Mitigation ideas: Bellows shielding

- To reach design luminosity, we need further background mitigation.
- One of ongoing project is an additional shield around bellows pipe where we see “hot spot” in data (also seen in simulation).
- Showers generated at  $z=1\text{m}$  leak out to the detector from the bellows part, where we cannot put enough shielding due to inner detector cables
- Shield design is ongoing. The beam loss simulation predicts LER coulomb bkg can be reduced by 53% (CDC), 28% (TOP) with this shield. Also effective to suppress Lumi-BG.

## Hot Spots around IR from V0 analysis

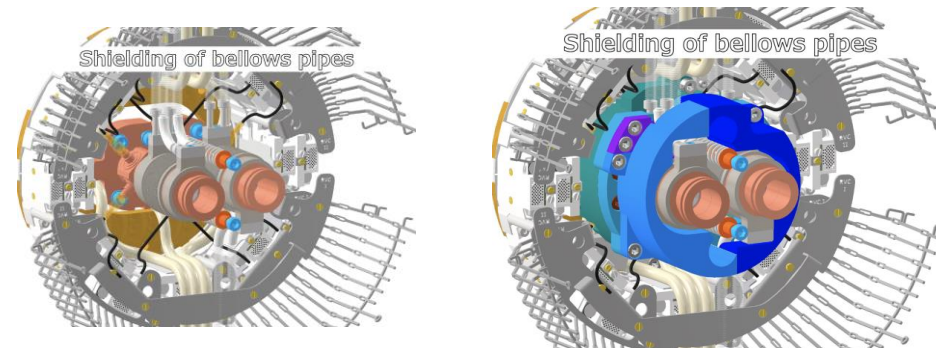
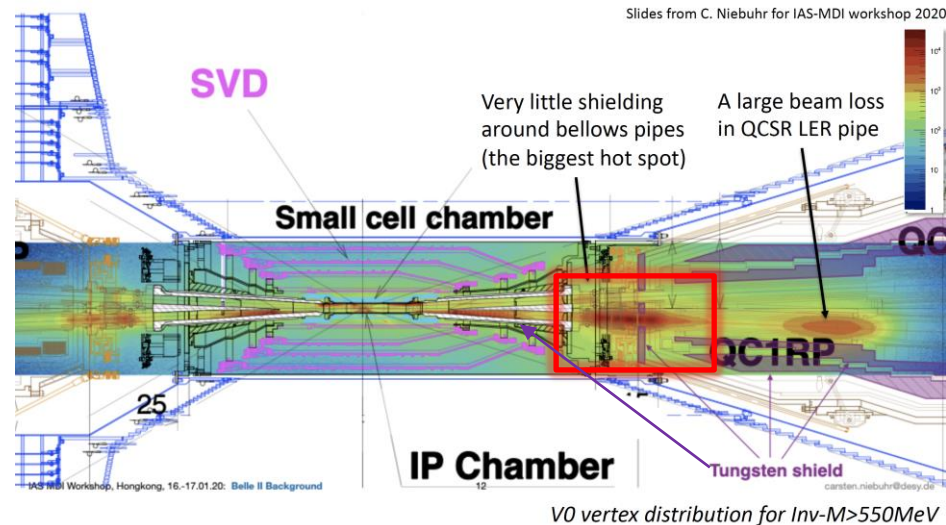

# SuperKEKB beam backgrounds

# 1. Touschek scattering

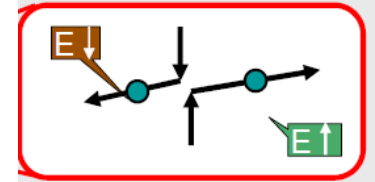

- Intra-bunch scattering :  $\text{Rate} \propto (\text{beam size})^{-1}, (E_{\text{beam}})^{-3}$
- Touschek lifetime: should be  $>600\text{sec}$  (required by injector ability)
  - ring total beam loss:  $\sim 375\text{GHz}$  (LER),  $\sim 270\text{GHz}$  (HER)
- **Countermeasure: horizontal collimators in the ring**
  - collimators added at  $0\sim 200\text{m}$  upstream IP are very effective
  - only  $O(100\text{MHz})$  loss inside Belle II detector
- Horizontal collimators are installed where  $\beta_x$  or  $\eta_x$  is large

$$d_x = \text{Max}[d_{x\beta}, d_{x\eta}], \quad d_{x\beta} = n_x \sqrt{\varepsilon_x \beta_x}, \quad d_{x\eta} = \eta_x (n_z \sigma_\delta)$$

# 2. Beam-gas scattering

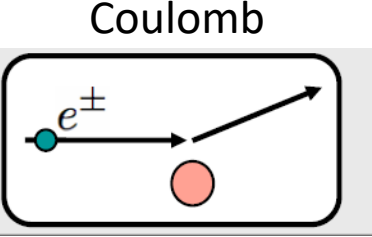
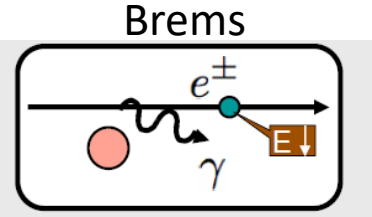

- Scattering by remaining gas, Rate  $\propto I \times P$
- Due to smaller beam pipe aperture and larger maximum  $\beta\gamma$  at SuperKEKB, beam-gas Coulomb scattering could be more dangerous than in KEKB

$$\frac{1}{\tau_R} = c n_G \langle \sigma_R \rangle = c n_G \frac{4\pi \sum Z^2 r_e^2}{\gamma^2} \left\langle \frac{1}{\theta_c^2} \right\rangle$$

$\sigma_R$ : cross section of the scattering  
 $Z$ : atomic number of gas nucleus,  $n_G = 2P/k_B/T$

- Countermeasures: Vertical collimators in the ring
  - very narrow (<~2mm) collimators
  - **TMC instability issue** at high current
  - Need to install where beta<sub>y</sub> is rather small

	KEKB LER	SuperKEKB LER
QC1 beam pipe radius: $r_{QC1}$	35mm	<b>13.5mm</b>
Max. vertical beta (in QC1): $\beta_{y, QC1}$	600m	<b>2900m</b>
Averaged vertical beta: $\langle \beta_y \rangle$	23m	50m
Min. scattering angle: $\theta_c$	0.3 mrad	0.036 mrad
Beam-gas Coulomb lifetime: $\tau_R$	>10 hours	<b>35 min</b>

# Where should we put the vertical collimators?

Collimator aperture should be narrower than QC1 aperture.

$$d/\sqrt{\varepsilon\beta} < r_{QC1}/\sqrt{\varepsilon\beta_{QC1}} \quad \Rightarrow \quad d_{\max} \propto \beta^{1/2}$$

TMC instability should be avoided.

Transverse Mode Coupling  
instability

Assuming following two formulae:

$$I_{\text{thresh}} = \frac{C_1 f_s E / e}{\sum_i \beta_i k_{\perp i}(\sigma_z)} > 1.44 \text{ mA/bunch (LER)}$$

taken from "Handbook of accelerator physics and engineering, p.121"

Kick factor  $k_{\perp} = 0.215 A Z_0 c \sqrt{\frac{\theta}{\sigma_z d^3}}$   
(in case of rectangular collimator window)

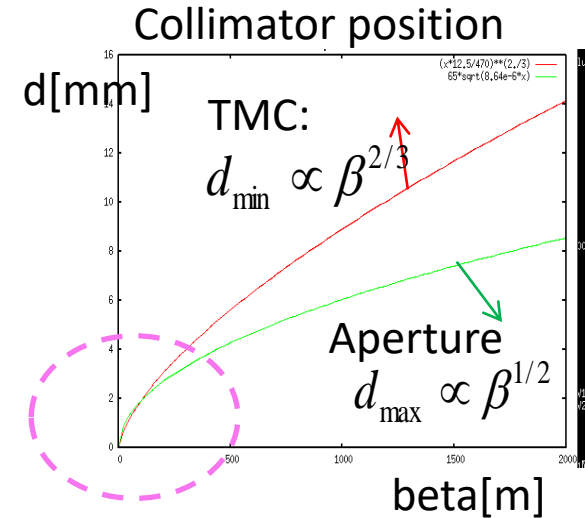

$$d_{\min} \propto \beta^{2/3}$$

**We should put collimator where beta\_y is rather SMALL!**

For more details, please check out following paper:

H. Nakayama et al, "Small-Beta Collimation at SuperKEKB to Stop Beam-Gas Scattered Particles and to Avoid Transverse Mode Coupling Instability", Conf. Proc. C **1205201**, 1104 (2012)



# 4. Luminosity-dependent background

## Radiative Bhabha scattering

- Rate  $\propto$  Luminosity (KEKBx40)
- Spent  $e^+/e^-$  with large  $\Delta E$  could be lost inside detector due to kick from detector solenoid kick (even with separate final focus magnets for each ring)
- Emitted  $\gamma$  hit downstream magnet outside detector and generate neutrons via giant-dipole resonance

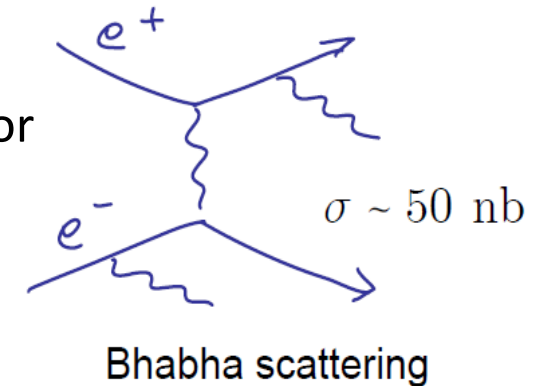

## 2-photon process

- Rate  $\propto$  Luminosity (KEKBx40)
- $e^+ e^- \rightarrow e^+ e^- e^+ e^-$
- Emitted  $e^+e^-$  pair curls by solenoid and might hit inner detectors multiple times

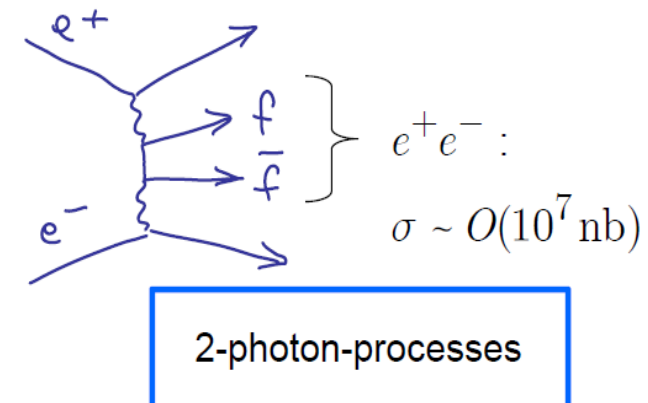

# Simulated IR beam loss distribution (design luminosity)

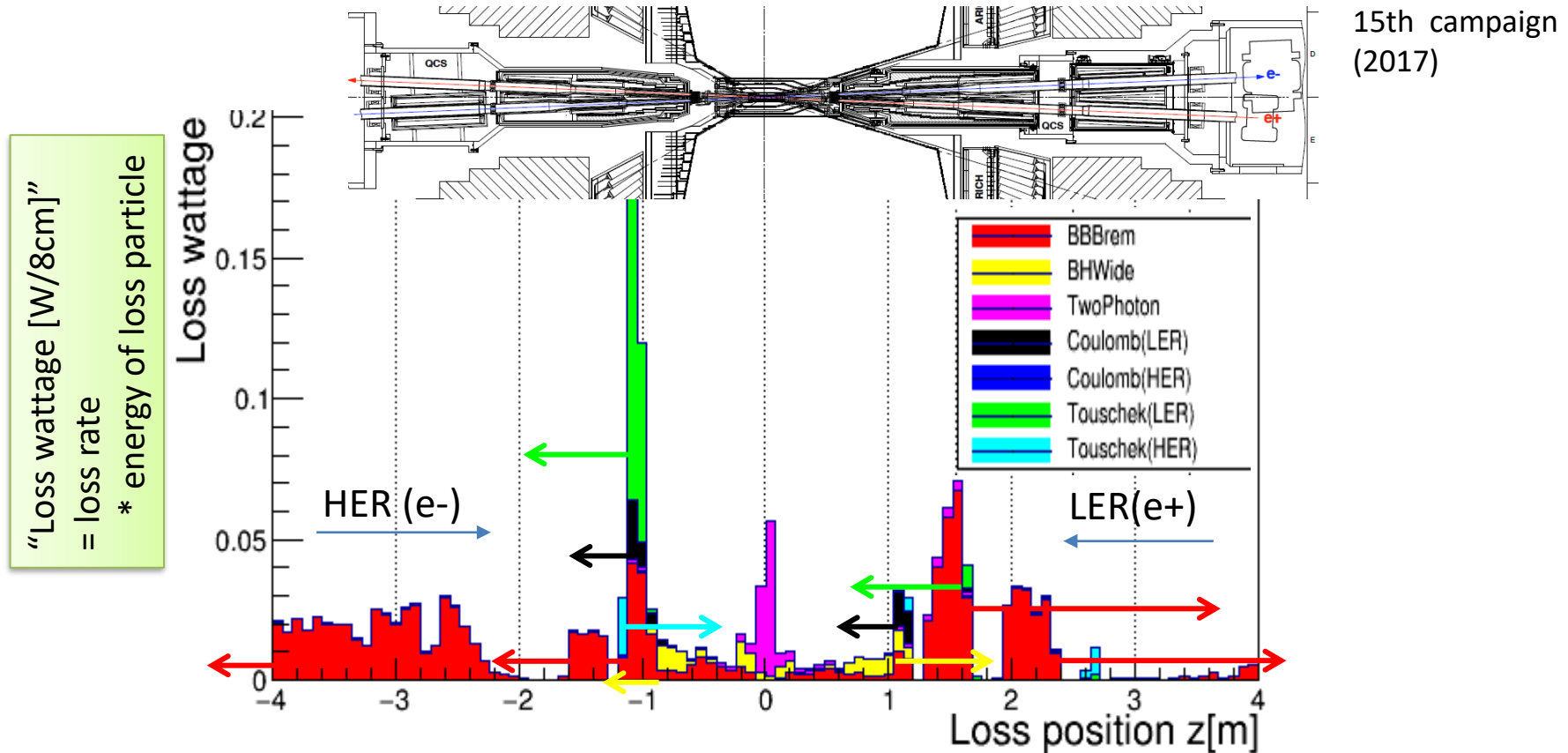

	LER (4GeV e+)	HER (7GeV e-)
Lumi-dependent BG	BBBrem: <b>1.08 W</b> (0.06 W in $ z  < 65\text{cm}$ ) BHWide: 0.11 W (0.04 W), 2photon: 0.14 W(0.11W)	
Touschek	0.27 W (0.42GHz)	0.04 W (0.03GHz)
Coulomb	0.06 W (0.10Hz)	0.00 W (0.002GHz)

# Final focusing magnets

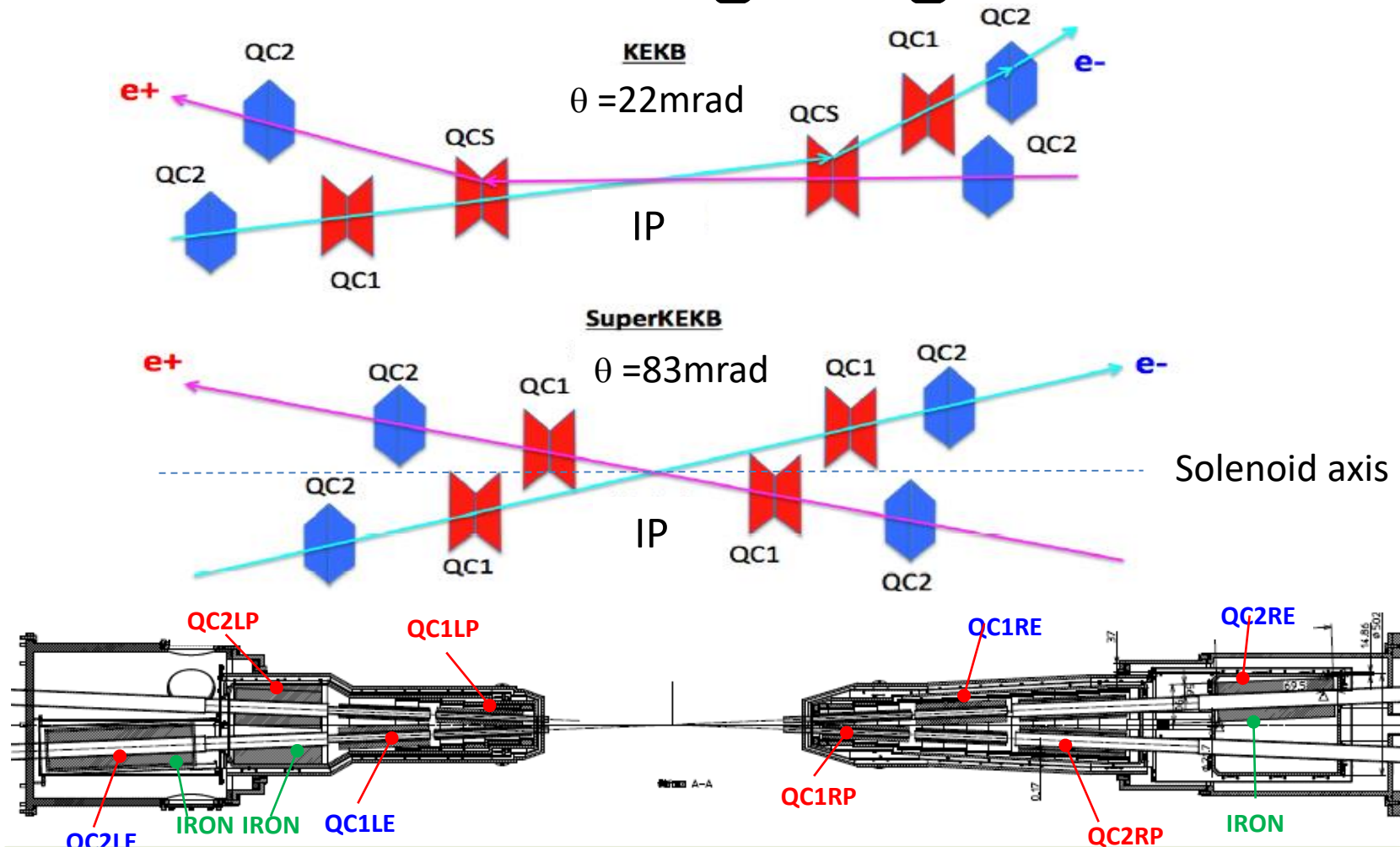

- Larger crossing angle  $\theta$  than KEKB
- Final Q for each ring  $\rightarrow$  more flexible optics design
- No bend near IP  $\rightarrow$  less emittance, less background from spent particles

# Spent e<sup>+</sup>/e<sup>-</sup> loss position after RBB scattering

LER(orig. 4GeV)

HER(orig. 7GeV)

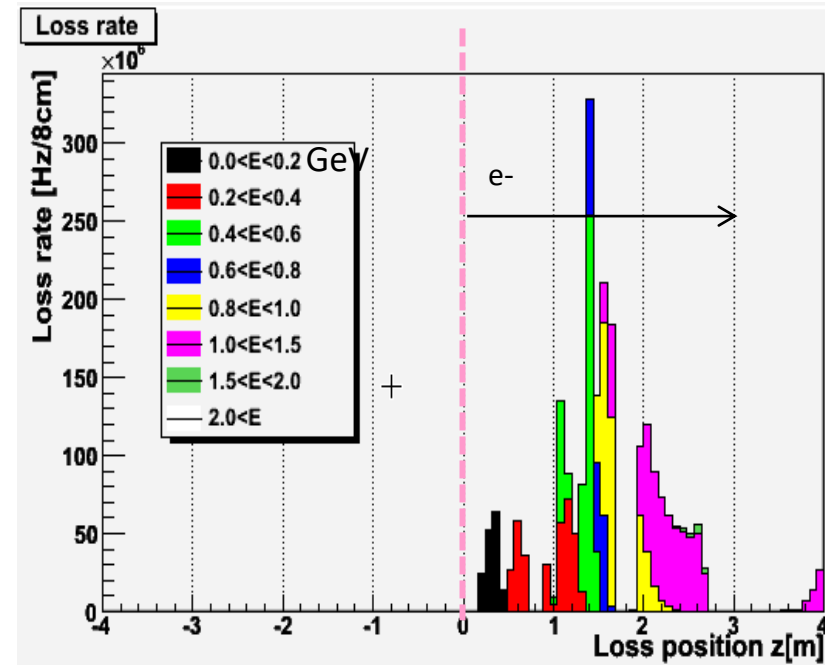
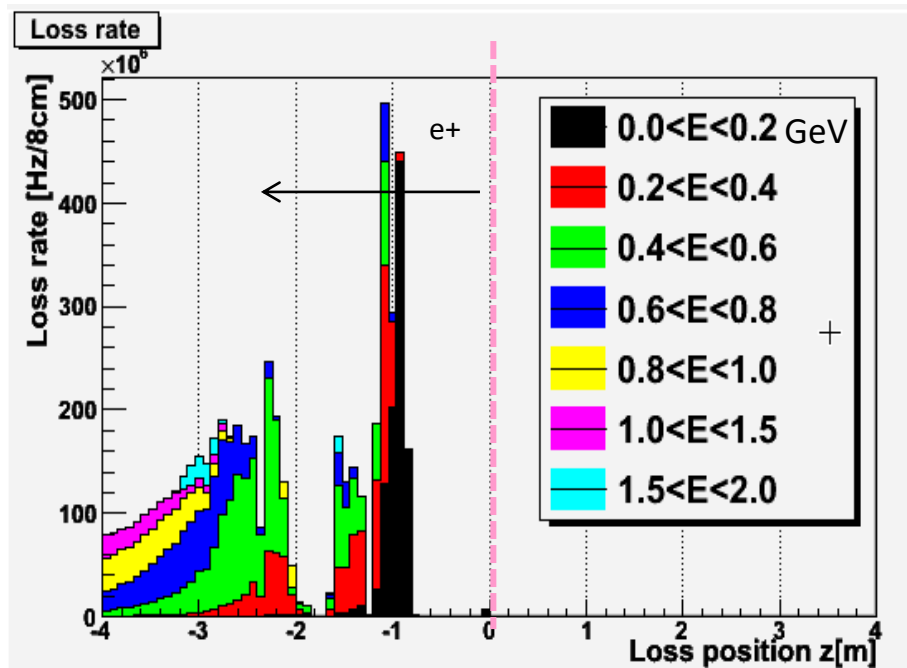

If  $\Delta E$  is large and e<sup>+</sup>/e<sup>-</sup> energy becomes less than 2GeV,  
they can be lost inside the detector (<4m from IP), due to  
kick by the 1.5T detector solenoid with large crossing angle(41.5mrad)

# Beam orbit after RBB scattering

## LER

x : positive=ring outer, y: positive=downward

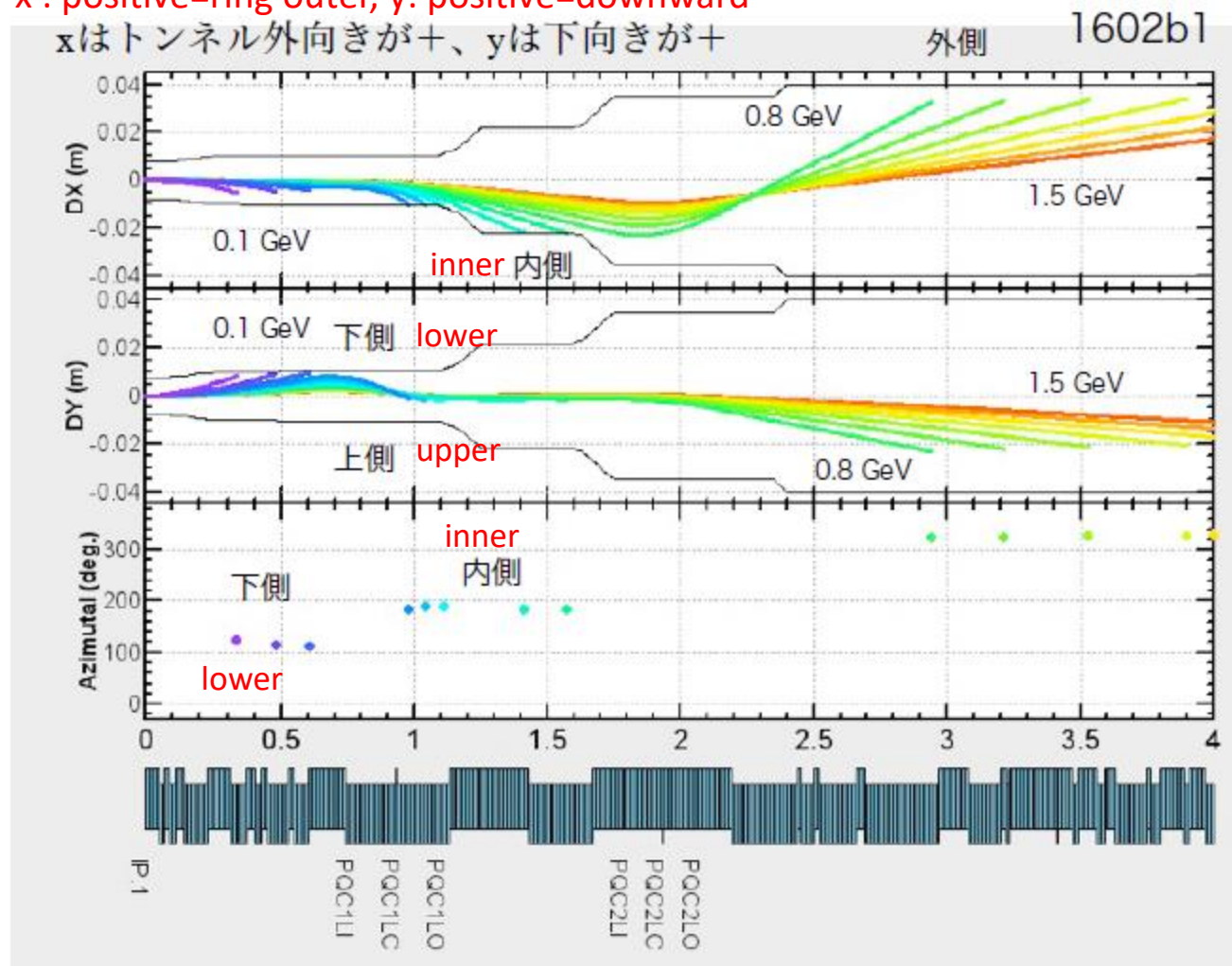

4

2011年10月26日水曜日

# MDI design



# How to cope with those beam BG?

- Movable collimators

- Horizontal collimators at arc sections and the straight section near IP for Touschek BG
- Very narrow ( $\sim < 2\text{mm}$  half width) vertical collimators for Beam-gas BG

- Shielding structures

- Thick tungsten structures inside final focus cryostat and vertex detector volume
- Stops showers from beam loss “hot spot” ★ at  $\sim 1\text{m}$  upstream from IP (maximum  $\beta_y$ )
- Polyethylene shields for neutrons

SuperKEKB horizontal collimator

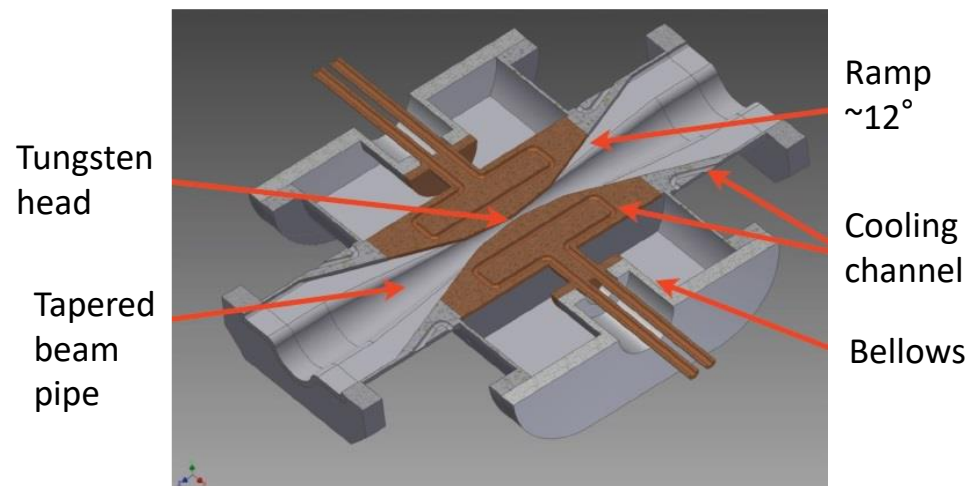

Final focus magnet cryostat, R-side

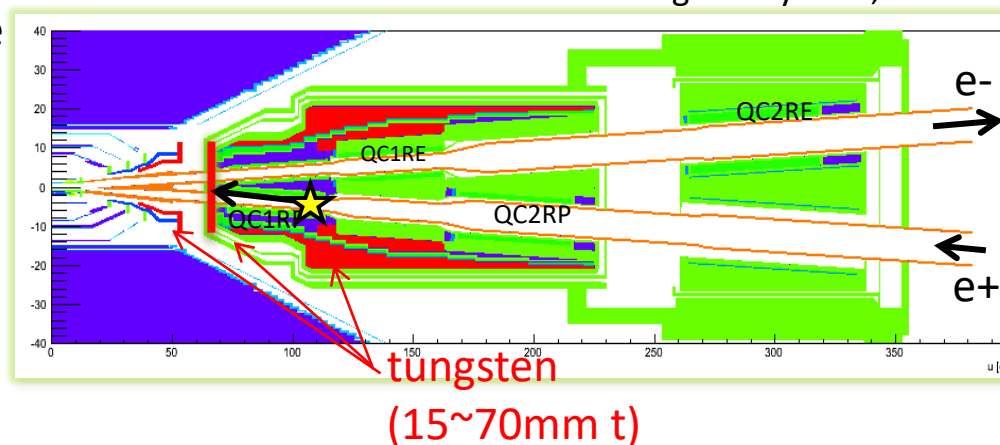

# Tungsten shields inside final focus cryostat

+ inside VXD volume

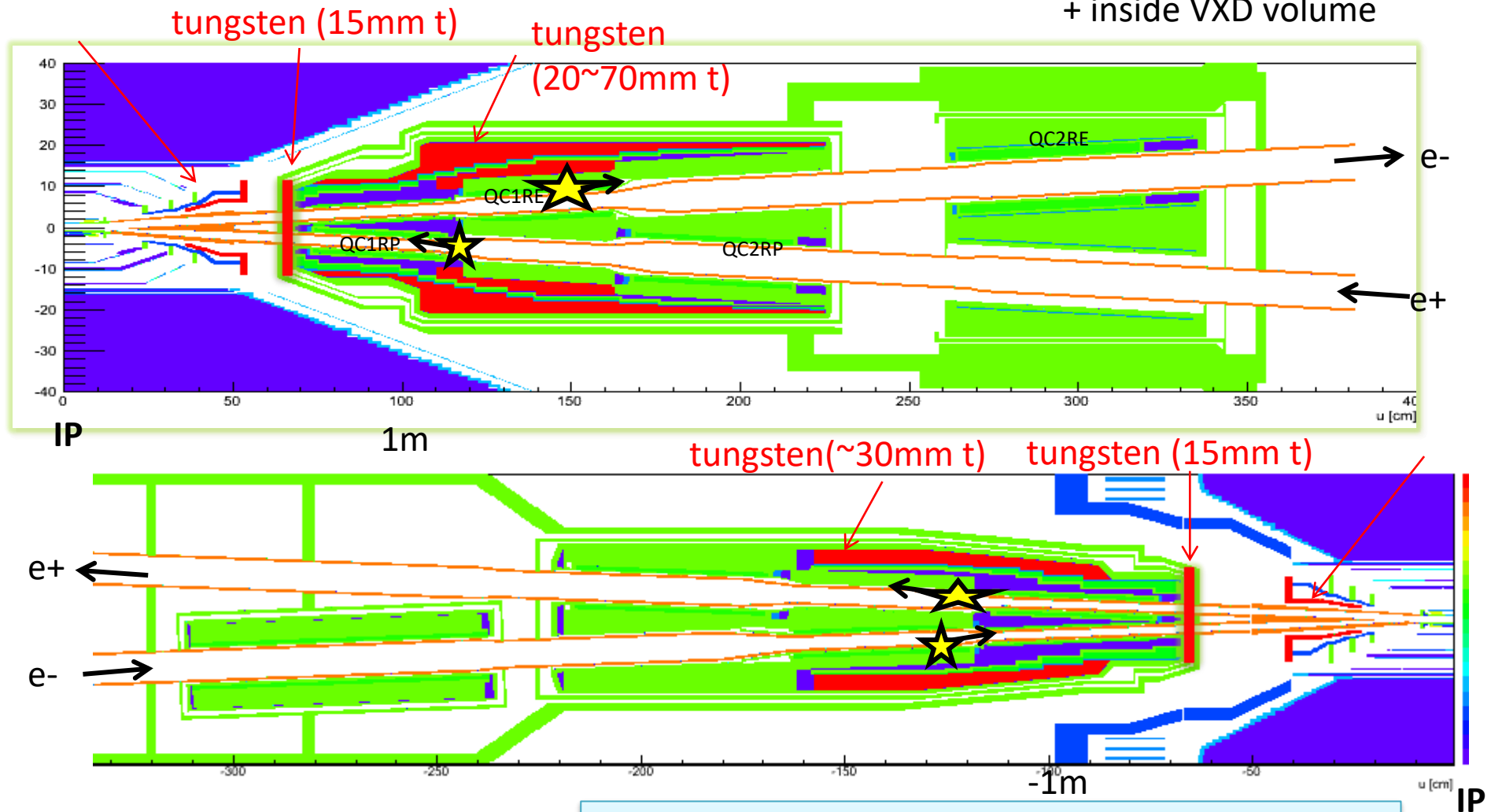



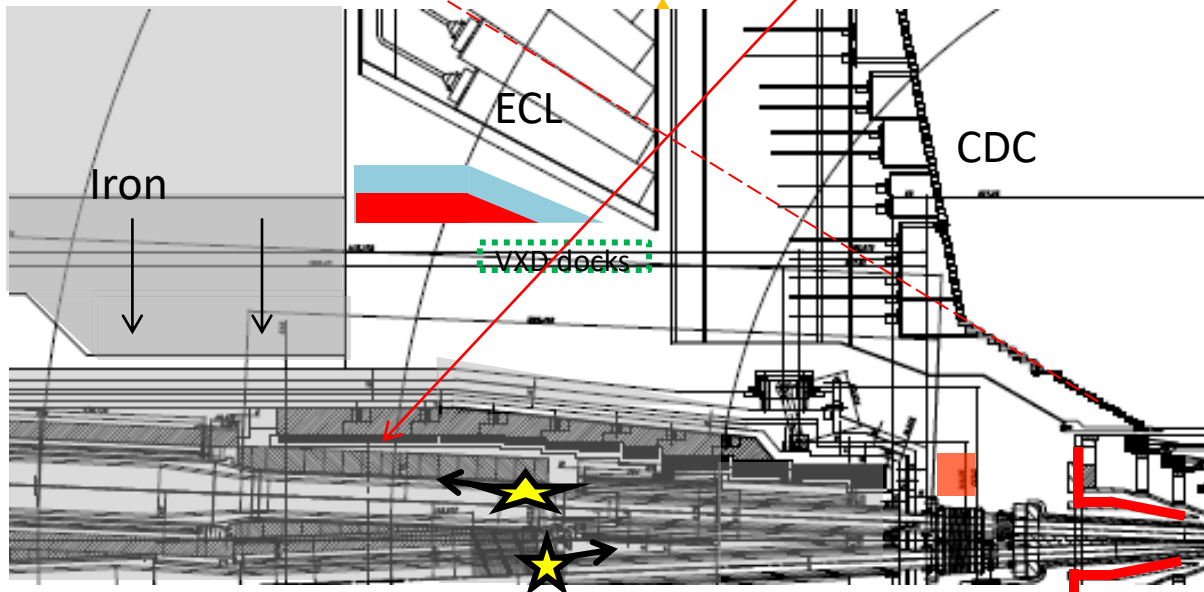
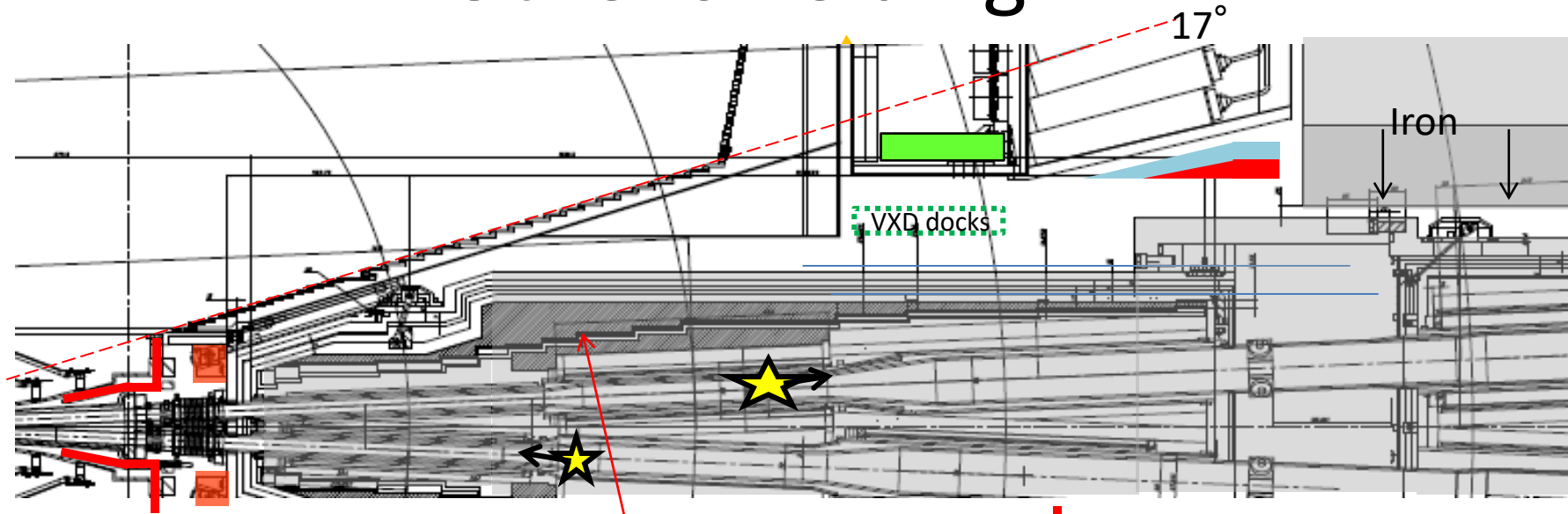

★ Major beam loss position by Touschek or Beam-gas

Thick tungsten shields can significantly stop background showers originated from  $|s| > 65\text{cm}$ .

# Other shielding



-  Heavy metal shields to protect VXD from showers generated in cryostat
-  Neutron shield to protect HAPDs in ARICH (Boron-doped Polyethylene)
-  ECL shield, for included for (Lead + Polyethylene)
-  Remote Vacuum Connection structure in front of QCS reduces showers from RBB loss at  $|s| \sim 60\text{cm}$  (6cm-thick SUS)

# Interaction region

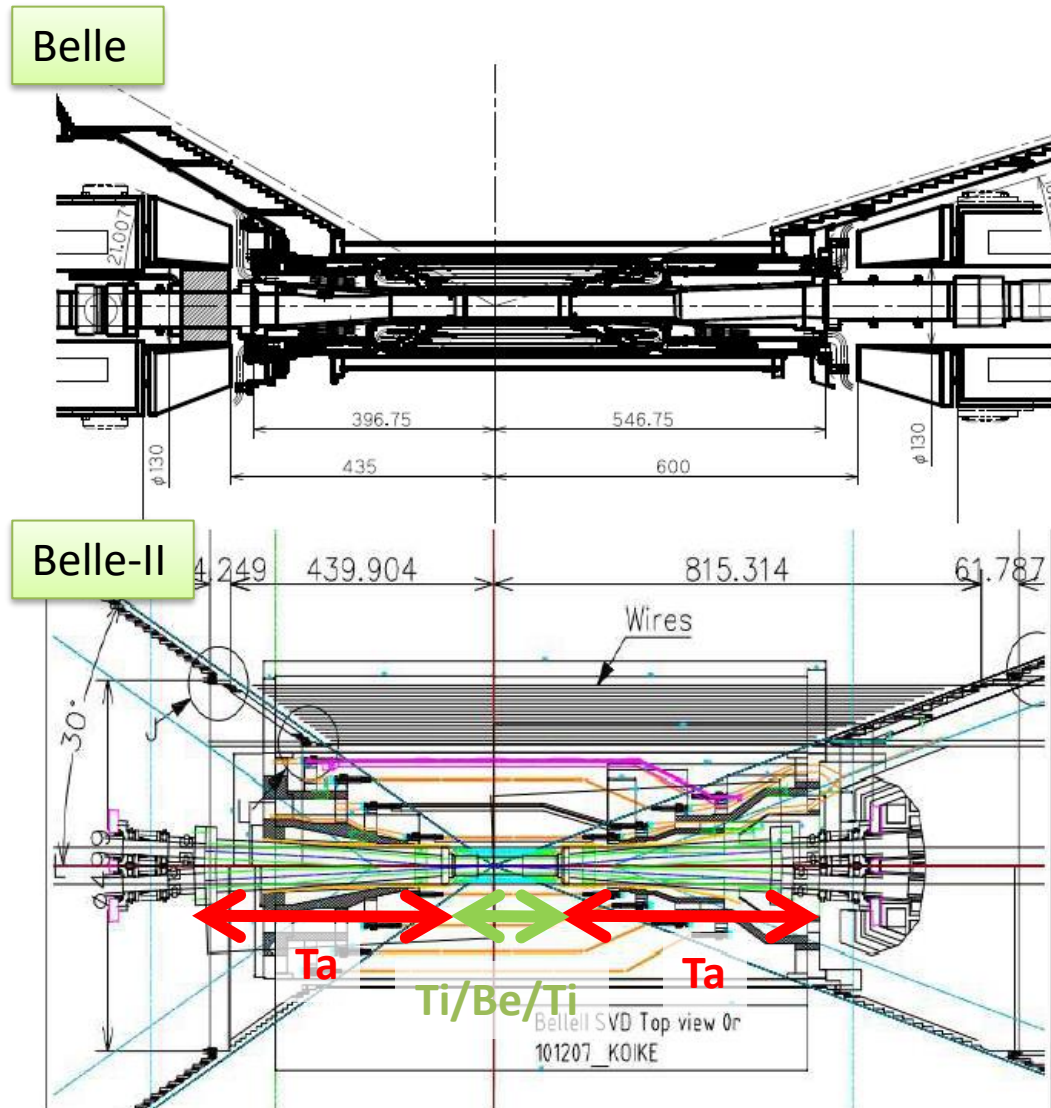

## <Belle-II>

- Smaller IP beam pipe radius ( $r=15\text{mm}\Rightarrow 10\text{mm}$ )
- Wider beam crossing angle ( $22\text{mrad}\Rightarrow 83\text{mrad}$ )
- Crotch part: Ta pipe
- Pipe crotch starts from closer to IP, complicated structure
- New detector: PXD (more cables should go out)





# Background Global picture

Ver. 2017.1.31

