

# CMS Detector – LEGO Model

The **CMS detector** is a huge scientific instrument located at CERN. The CMS detector is designed to study the collision of high-energy particles at the world's largest particle accelerator (LHC), with the goal to find out more about the elementary particles that make up our universe and the fundamental interaction that govern their behaviour.

The CMS detector is shaped like a cylindrical onion, with multiple layers of highly advanced detector systems. It is about 21 meters long and 15 meters high, weighing around 14 000 tons and sits in a cavern almost 100 metres underground.

**In this booklet, you will learn how to assemble a LEGO model of the CMS detector that is about 250x smaller than the real detector. While assembling the different layers, you can learn more about how the CMS detectors works.**

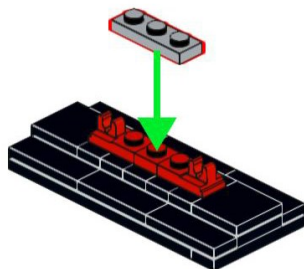
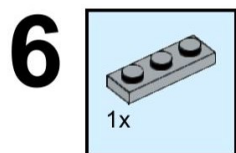
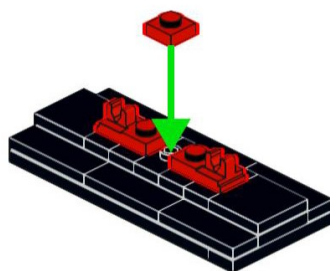
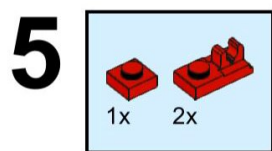
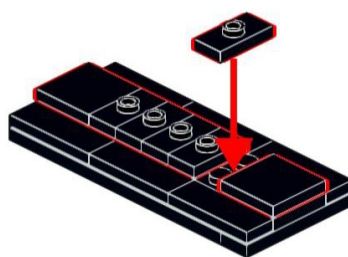
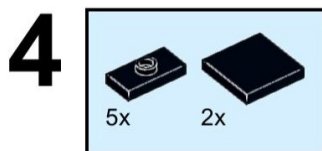
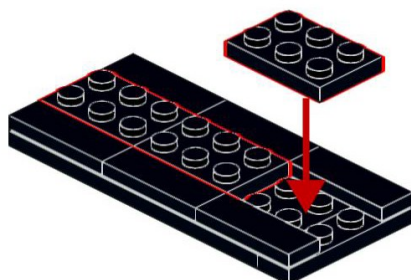
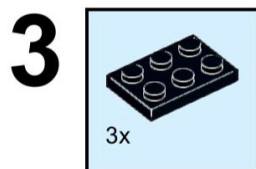
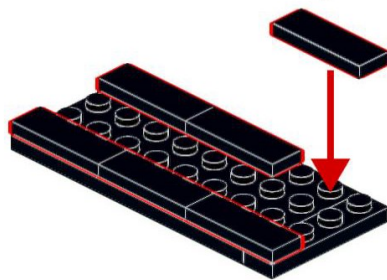
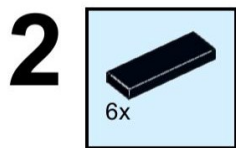
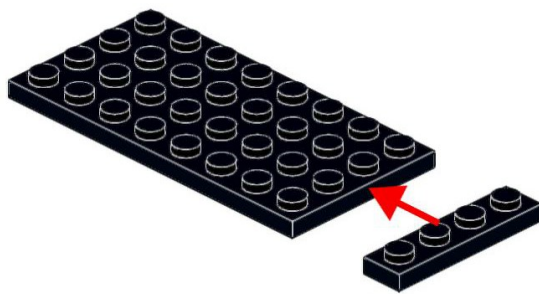
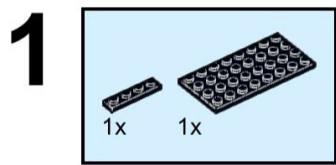

### Inner tracking system

The innermost layer consists of silicon detectors that track the paths of electrically charged particles. The technology is quite similar to the one used in the camera of your smartphone. Scientists analyse how particles interact with the silicon detectors to reconstruct their trajectories accurately and find out, e.g. where exactly a particle collision took place.

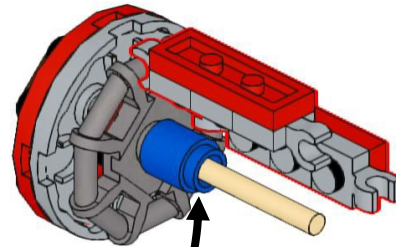
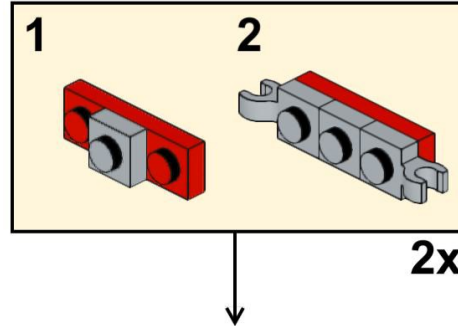
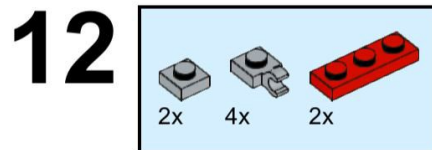
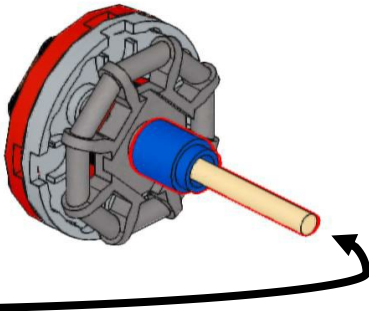
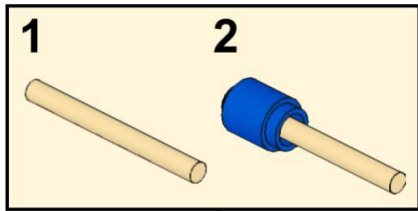
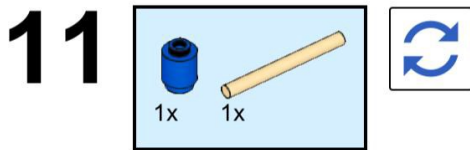
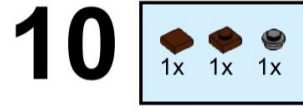
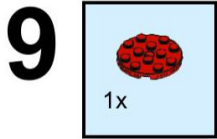
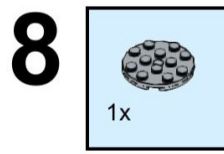
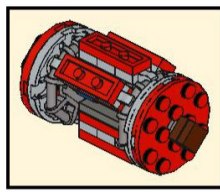
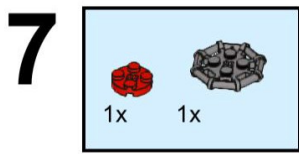

## Calorimeters (Electromagnetic & Hadronic)

Calorimeters help scientists measure the energy of particles; they are basically energy meters. CMS uses two types of calorimeters (electromagnetic & hadronic), one focuses on particles such as electrons and photons, the other one focuses on particle systems called hadrons. By analysing the patterns particles leave inside the different layers of the calorimeters, scientists can distinguish different types of particles.



# 13

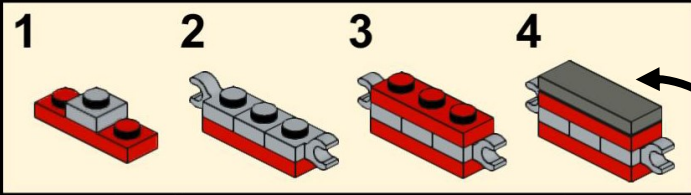
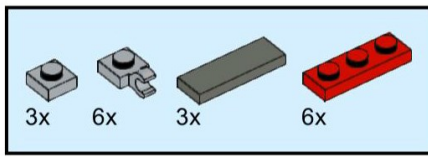

3x

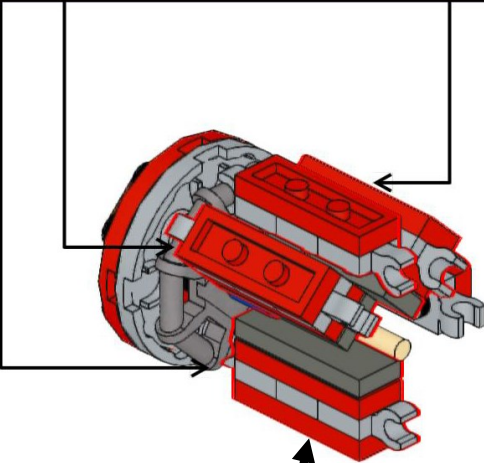

When an electrically charged particle moves through a magnetic field, it experiences a force. This force can make the particle change its path. By measuring in the direction in which a particle path bends, scientists can determine its electric charge (+ or -). The CMS detector uses a cylindrical electromagnet, a so-called solenoid. This solenoid uses an electric current of 20 000 Ampere to create a magnetic field of 4 Tesla.

**Electromagnet (Solenoid)**

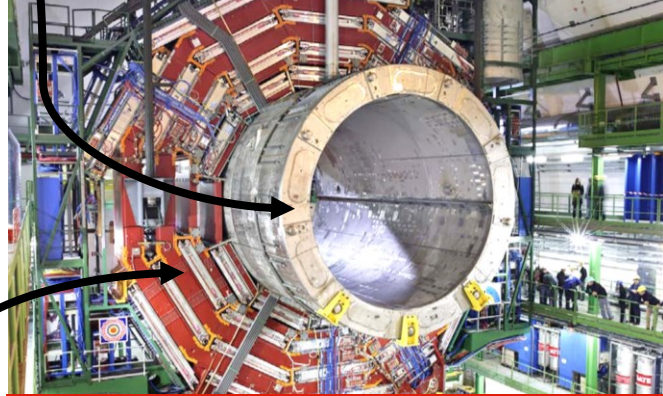

**Magnet Return Yoke**

The magnet return yoke is needed to control the magnetic field outside of the solenoid. It is made of more than 11000 tonnes of steel, which guides the magnetic field and also acts as the main support system (or “skeleton”).

# 14

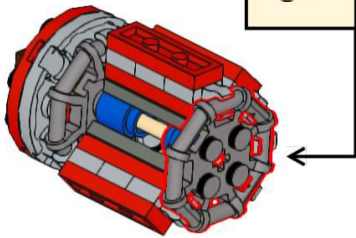
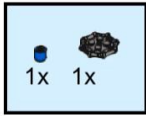

# 15

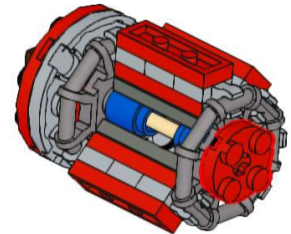
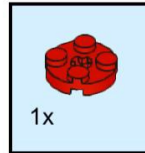

# 16

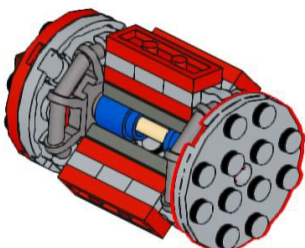
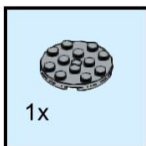

# 17

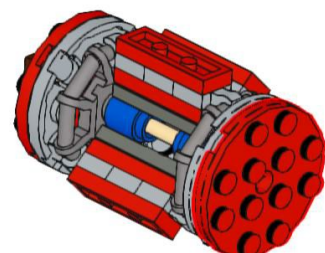
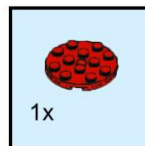

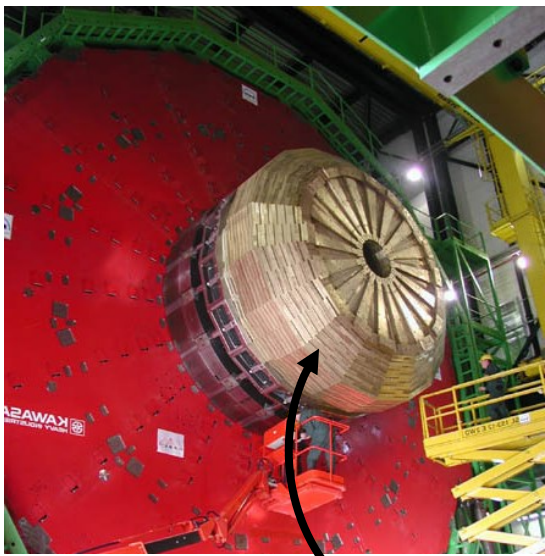

The forward calorimeter measures the energy of particles moving in directions close to the beam pipe. This part of the detector is exposed to very high levels of radiation. Therefore, it consists of special radiation-hard material such as steel absorbers and quartz fibres.

**Forward Calorimeter**

**18**

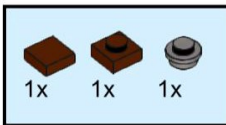

**19**

**20**

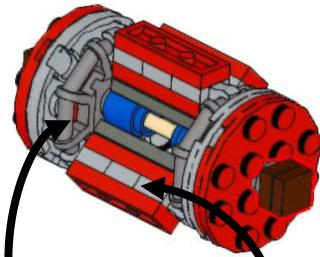
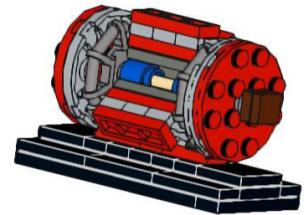
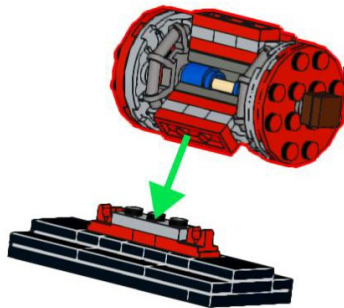
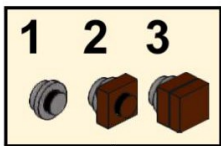

**Muon system**

Muons are electrically charged particles that are just like electrons and positrons, but with 200x more mass.

High energy muons are typically a sign for interesting physics. For example, the Higgs boson can transform into 4 muons. Therefore, the CMS detector has been specifically optimized for the detection and measurement of muons. Several layers of muon detectors are interleaved with the magnet return yoke.

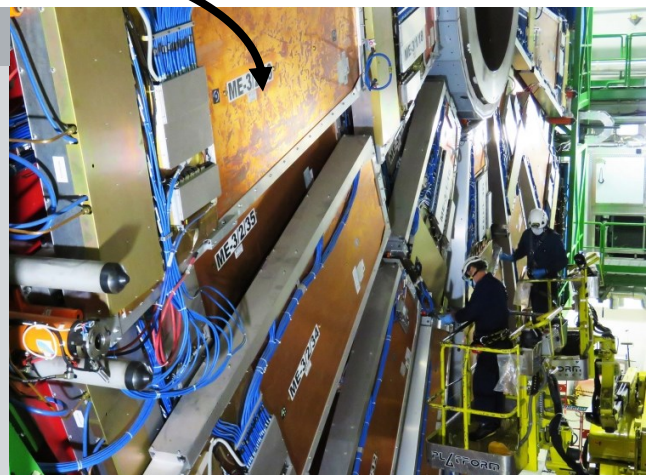

# Congratulations, you have assembled a model of a particle detector at CERN!

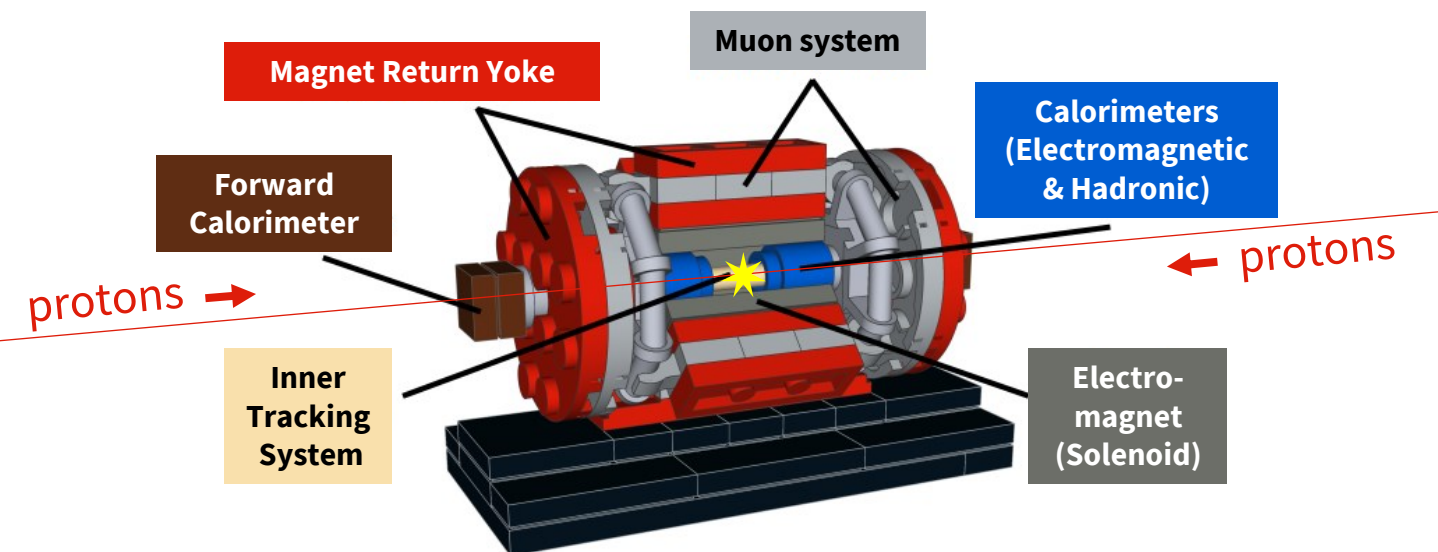

## Time for a quiz! Which detector system is doing what?

Electromagnet (Solenoid)	<input type="checkbox"/>	<input type="checkbox"/>	Control the magnetic field & support the detector
Magnet Return Yoke	<input type="checkbox"/>	<input type="checkbox"/>	Bend the path of electrically charged particles
Inner Tracking System	<input type="checkbox"/>	<input type="checkbox"/>	Detect muons
Calorimeters	<input type="checkbox"/>	<input type="checkbox"/>	Track the paths of electrically charged particles
Muon system	<input type="checkbox"/>	<input type="checkbox"/>	Measure the energy of particles

And that's how the real CMS detector looks like when it's open:

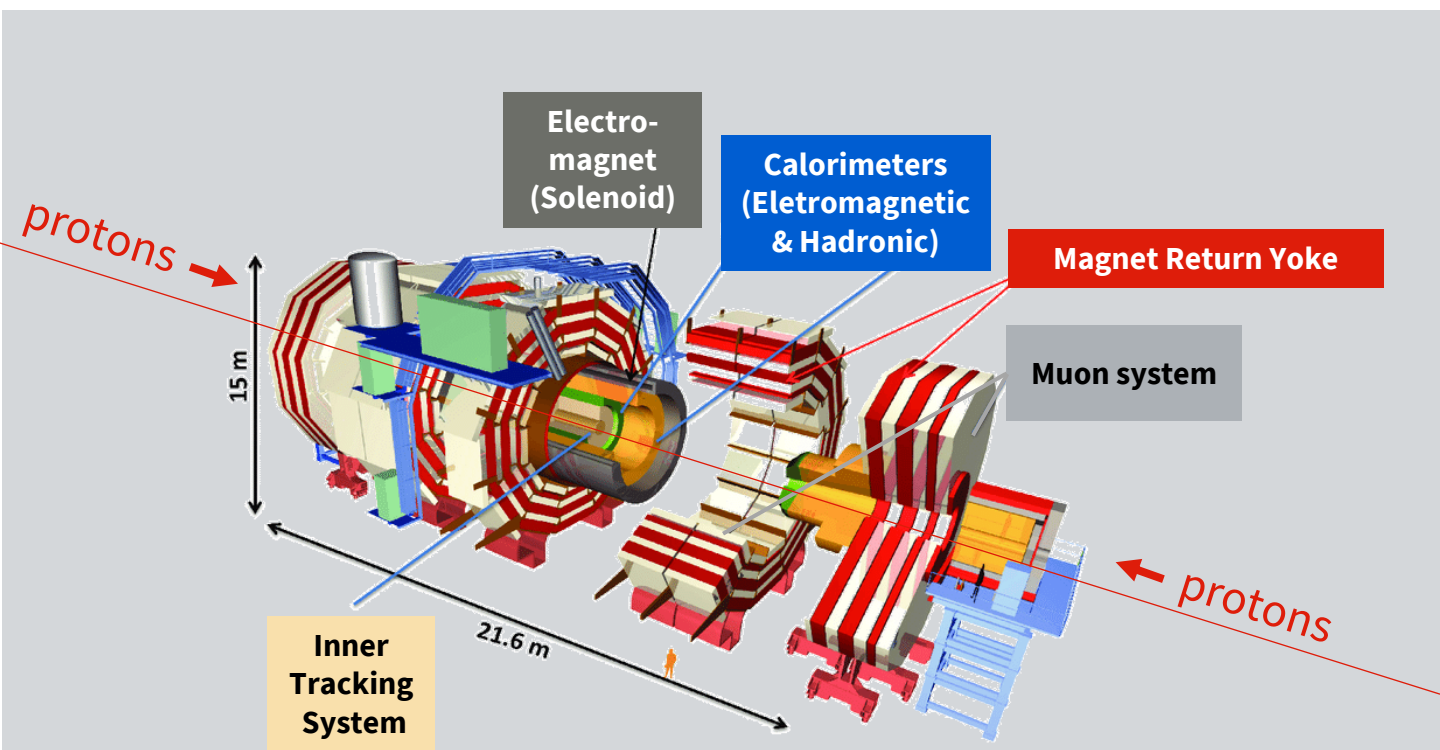
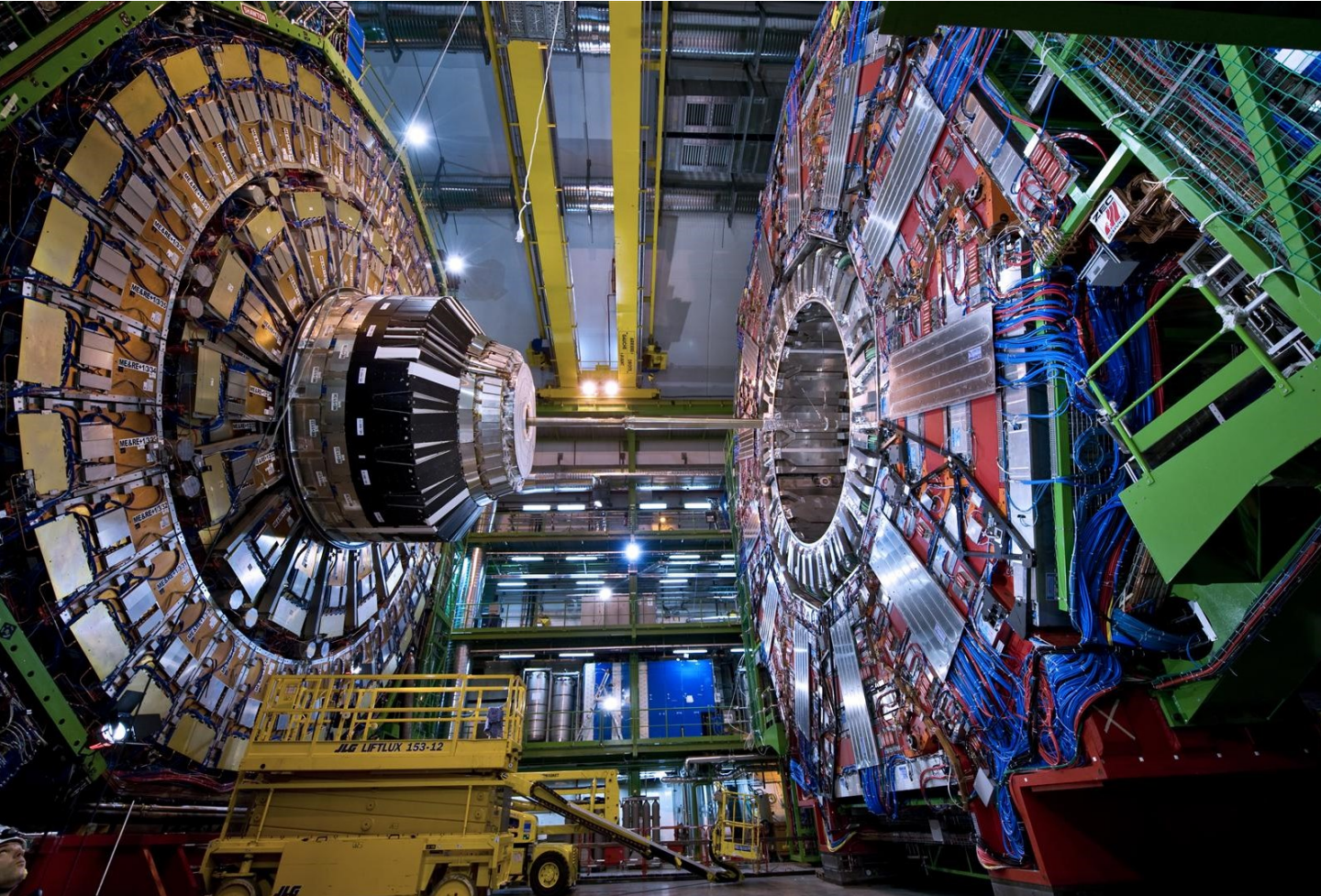

# Lab workshop

## **LEGO detectors**

Learn more about the different components  
of particle detectors

Idea, models and Images by Nathan Radihoff  
& Sascha Mehlhase

<https://build-your-own-particle-detector.org>

Version 7 July 2023

[sciencegateway.education@cern](mailto:sciencegateway.education@cern)

