

An Introduction to Engineering at CERN

Ray Veness
CERN

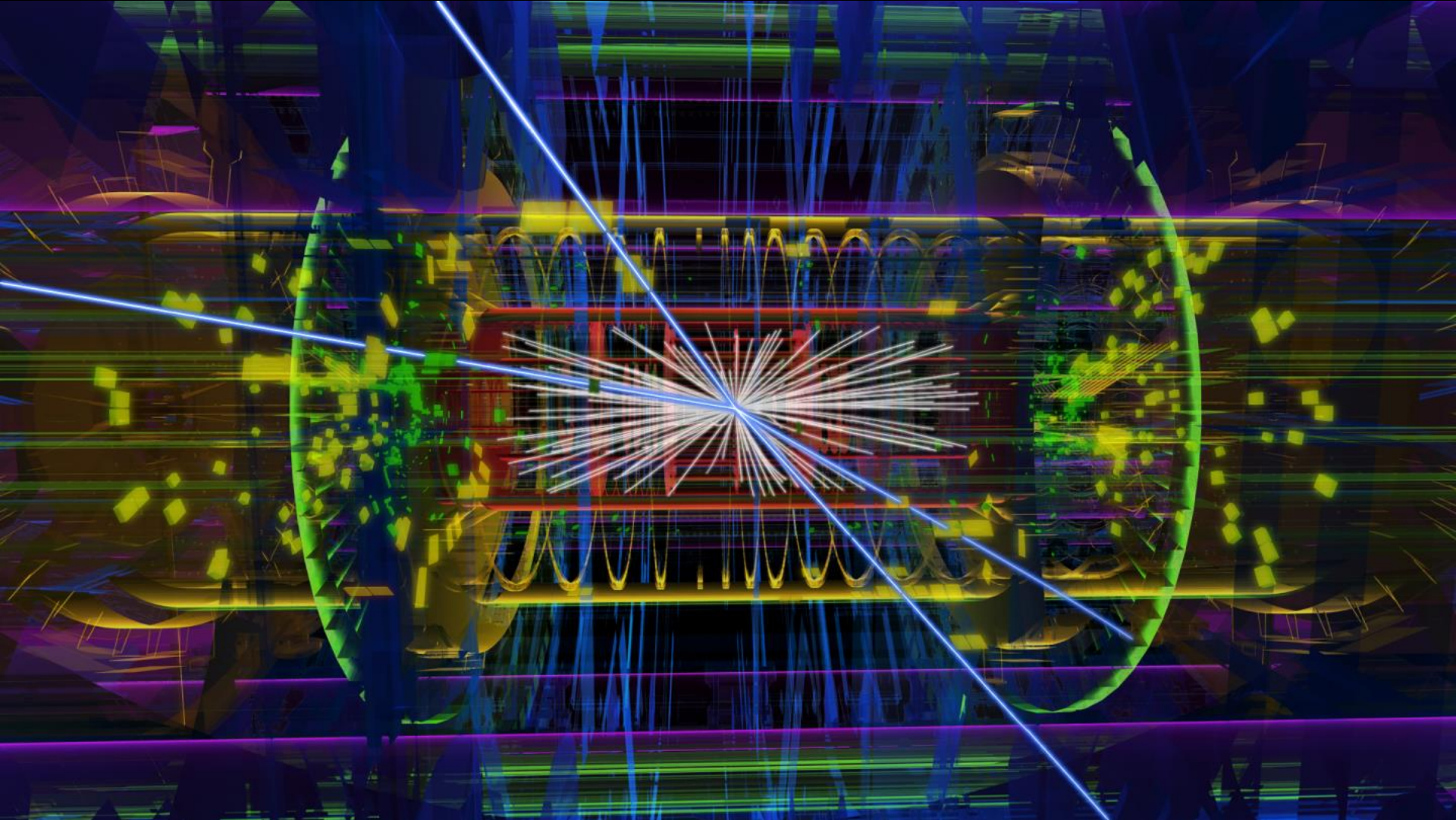

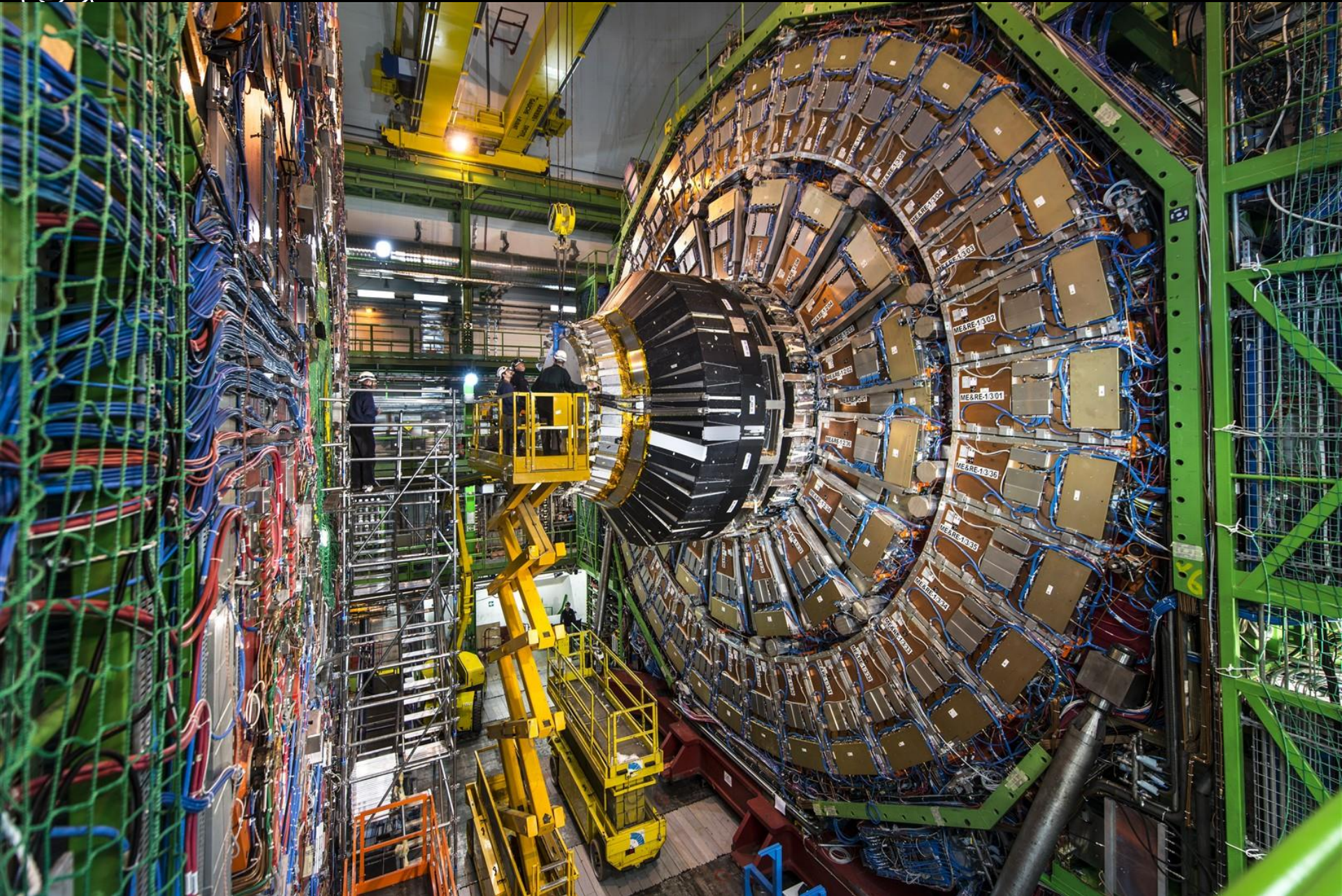





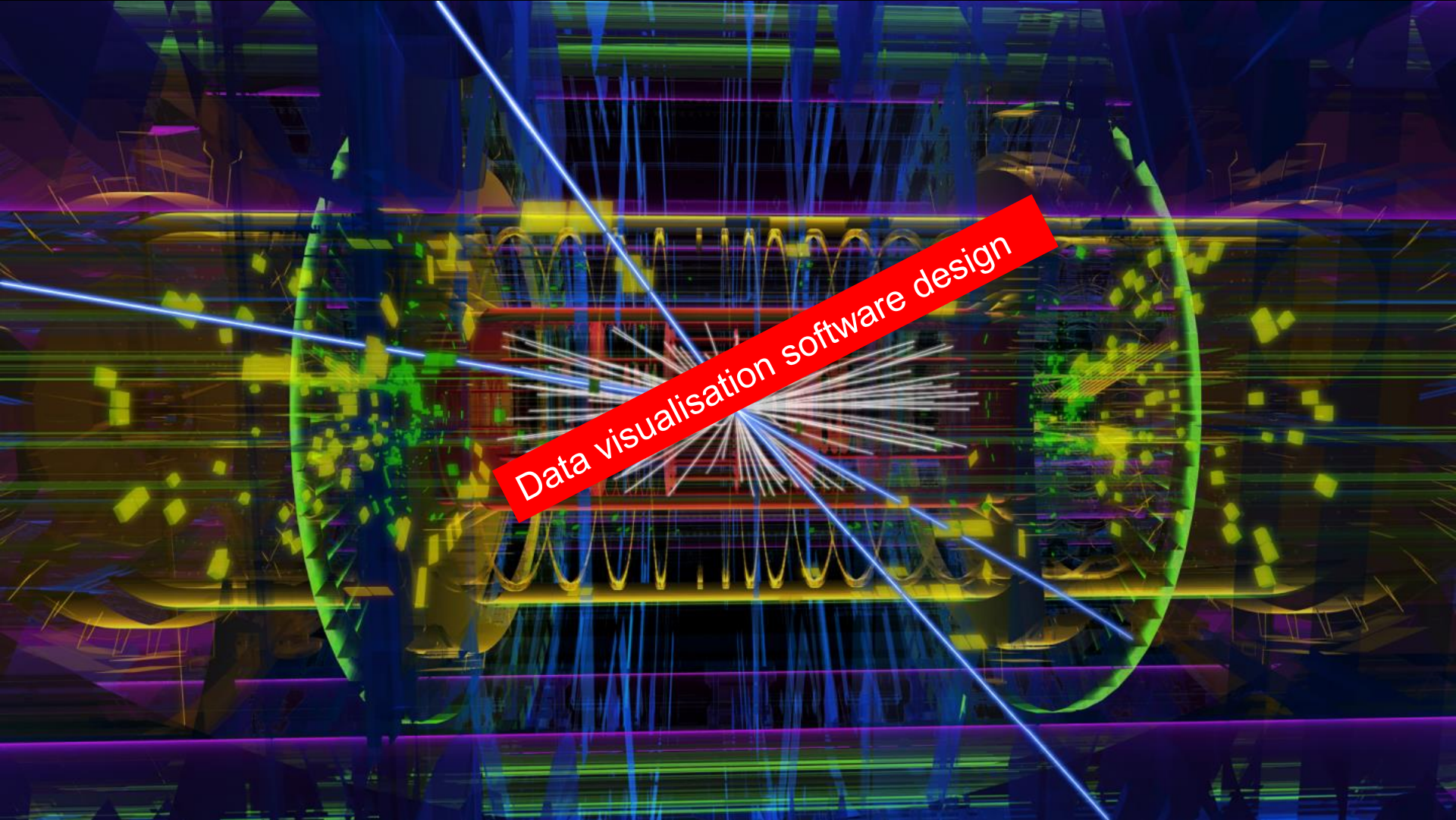

Data visualisation software design



Computer hardware

Databases

Network Infrastructures



3/4/2013 4:10:16 pm
4:10 pm 4:20 pm

Running jobs: 259835
Transfer rate: 6.15 GiB/sec



© 2013 Ches/Spot Image
Image © 2013 GeoContent
Image © 2013 TerraMetrics
Data SIO, NOAA, U.S. Navy, NGA, GEBCO
GOOGLE EARTH

Google earth
Terms of Use

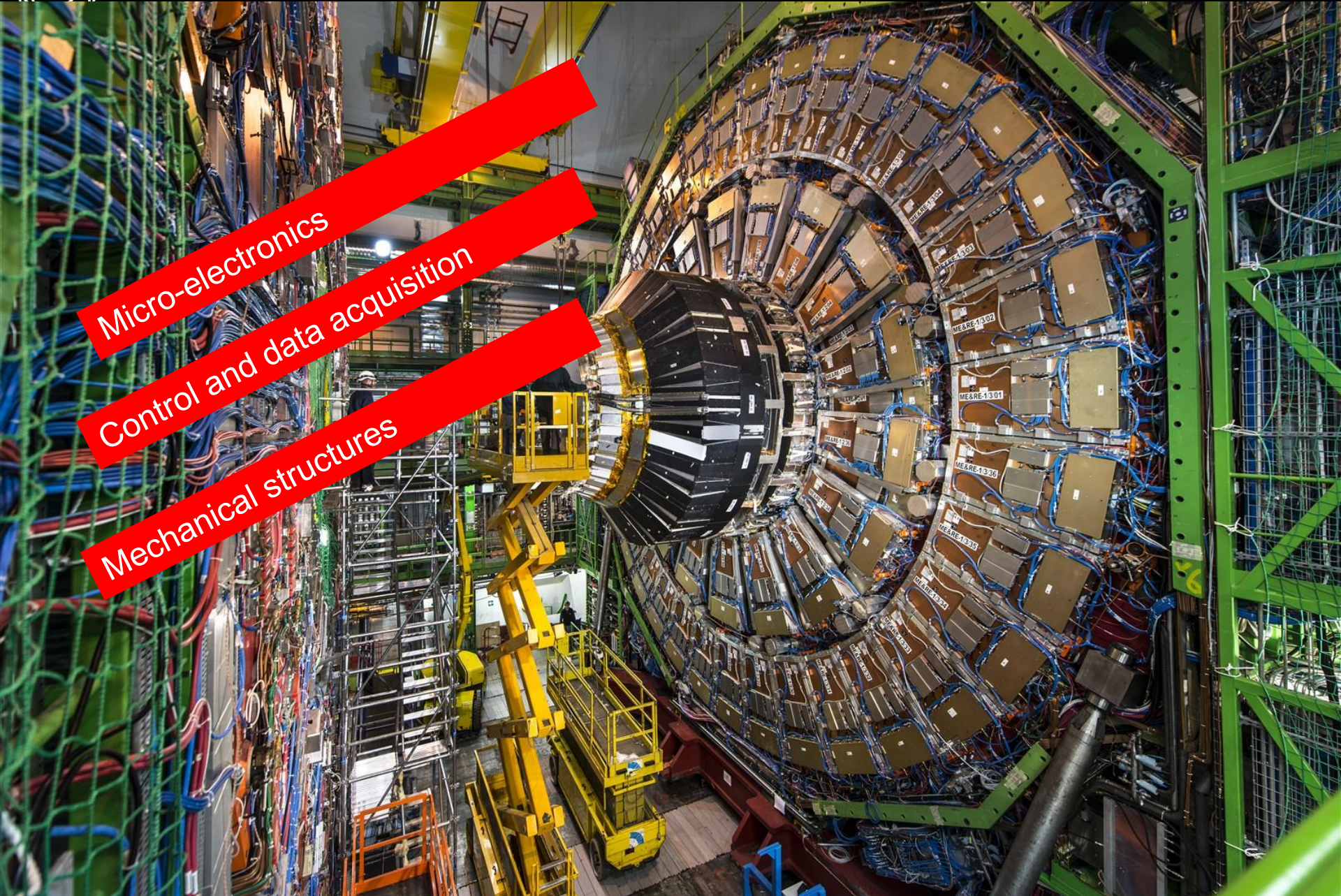

Micro-electronics

Control and data acquisition

Mechanical structures



Microchips for Megastructures

Front-End ASIC

CMS experiment on the LHC accelerator at CERN

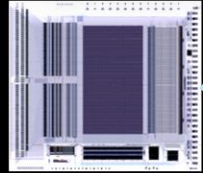

Silicon Tracker Hybrid

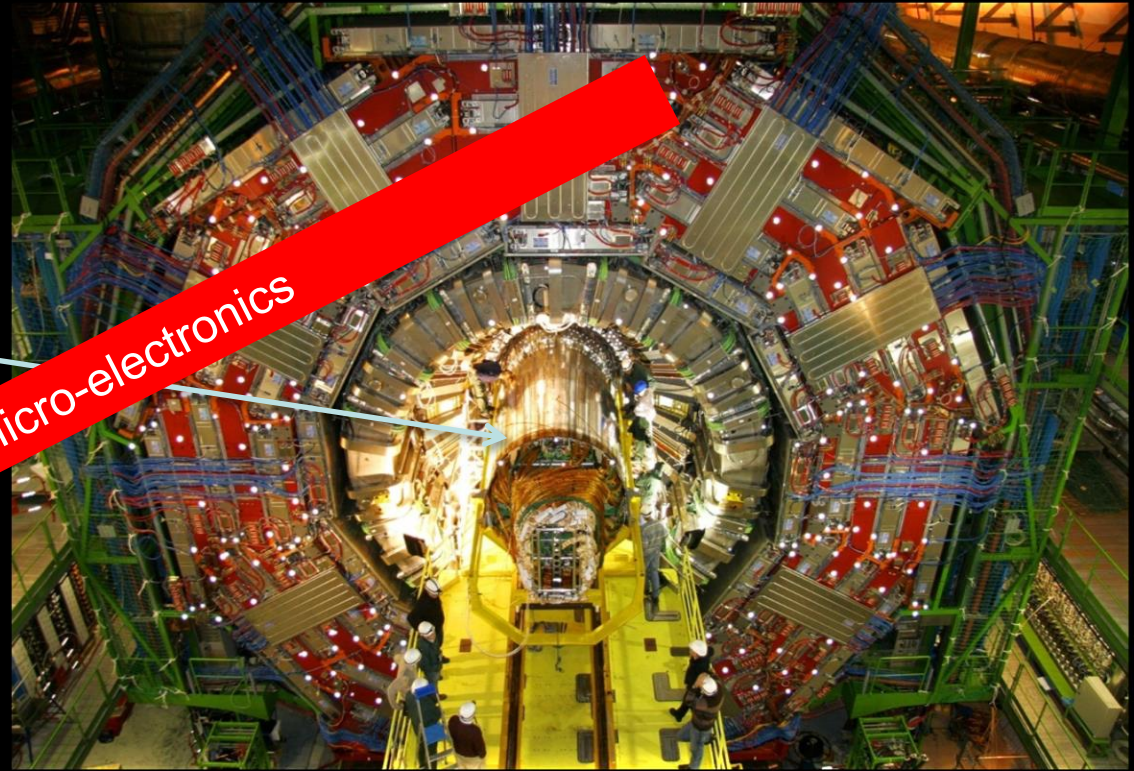
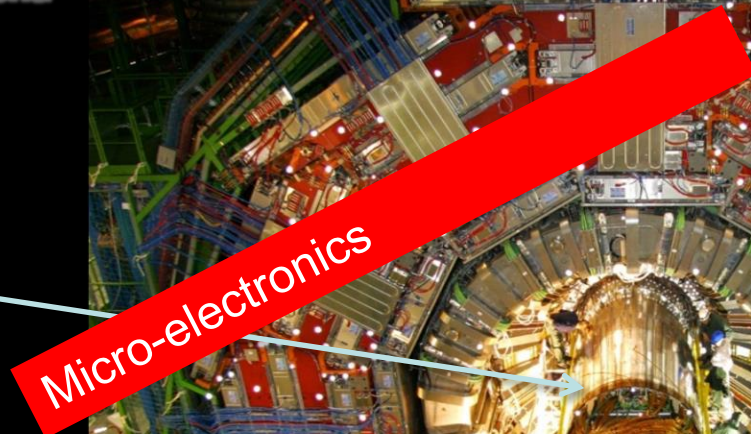
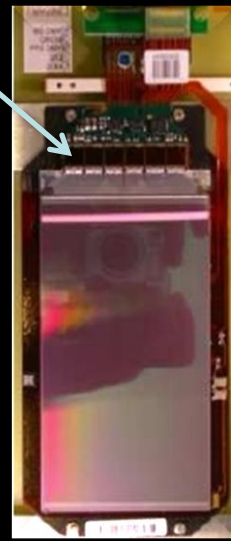

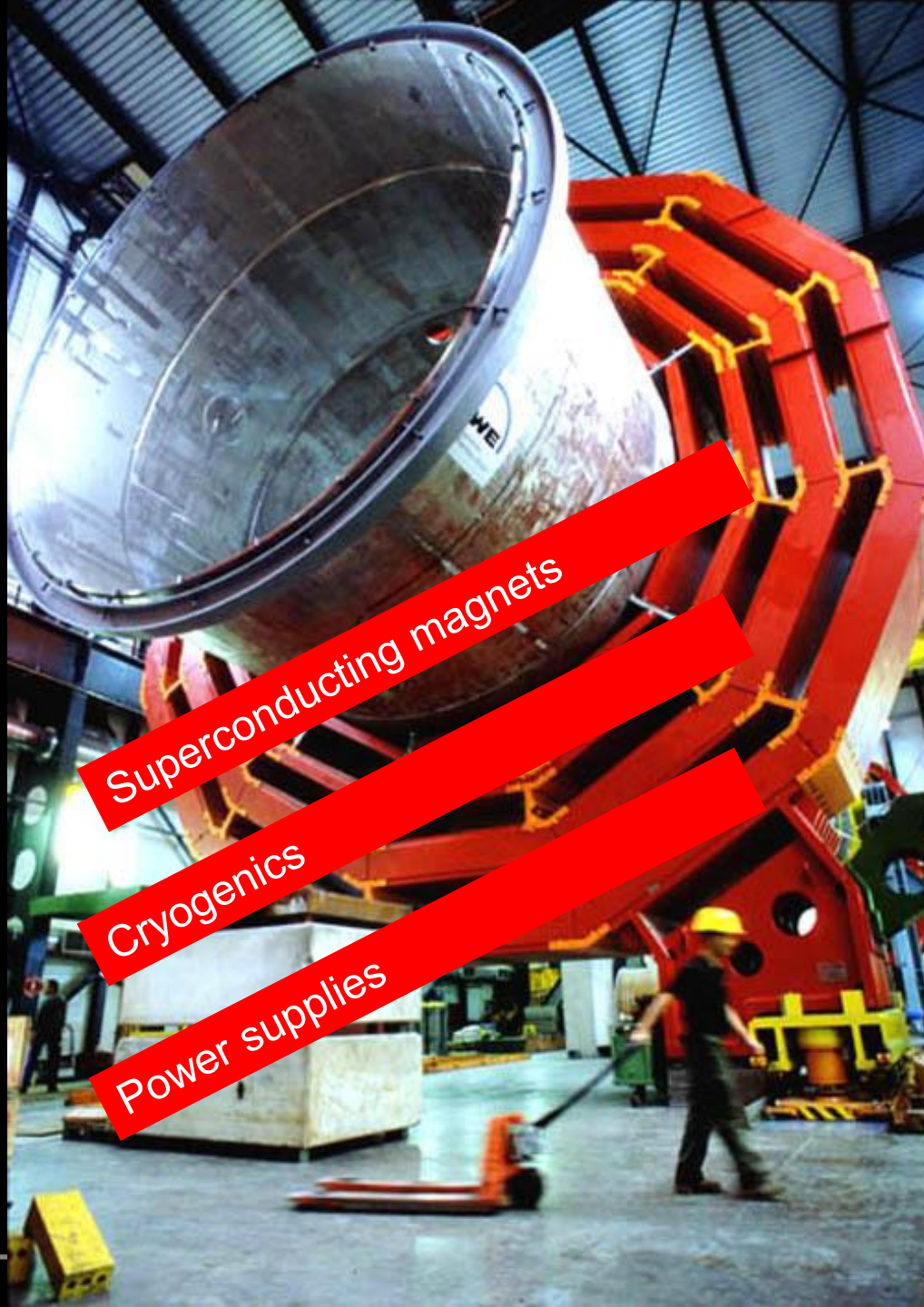

Superconducting magnets

Cryogenics

Power supplies

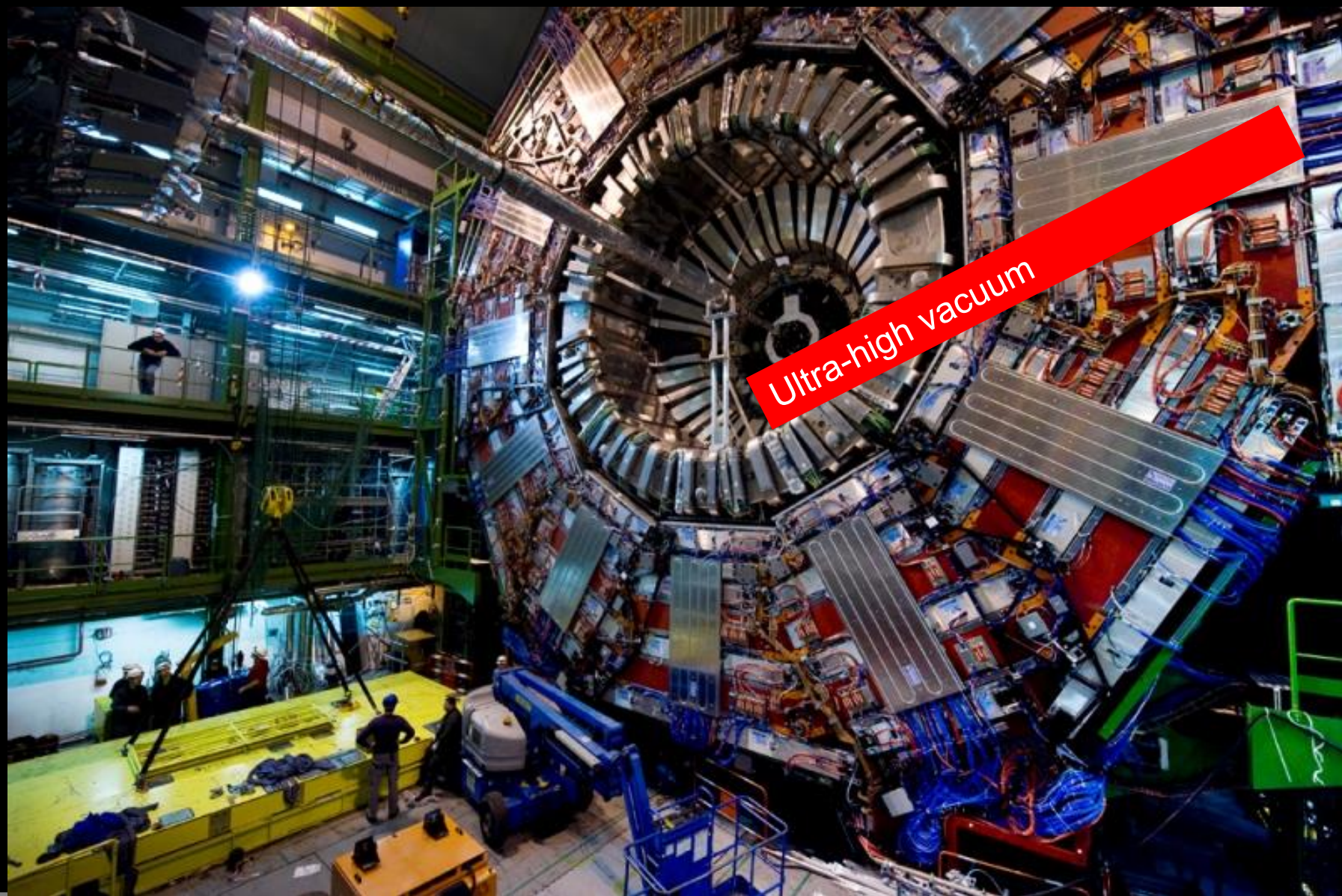

Ultra-high vacuum





Point 5 -Excavation commencement of PM54 shaft - July 09, 1999 - CERN ST-CE



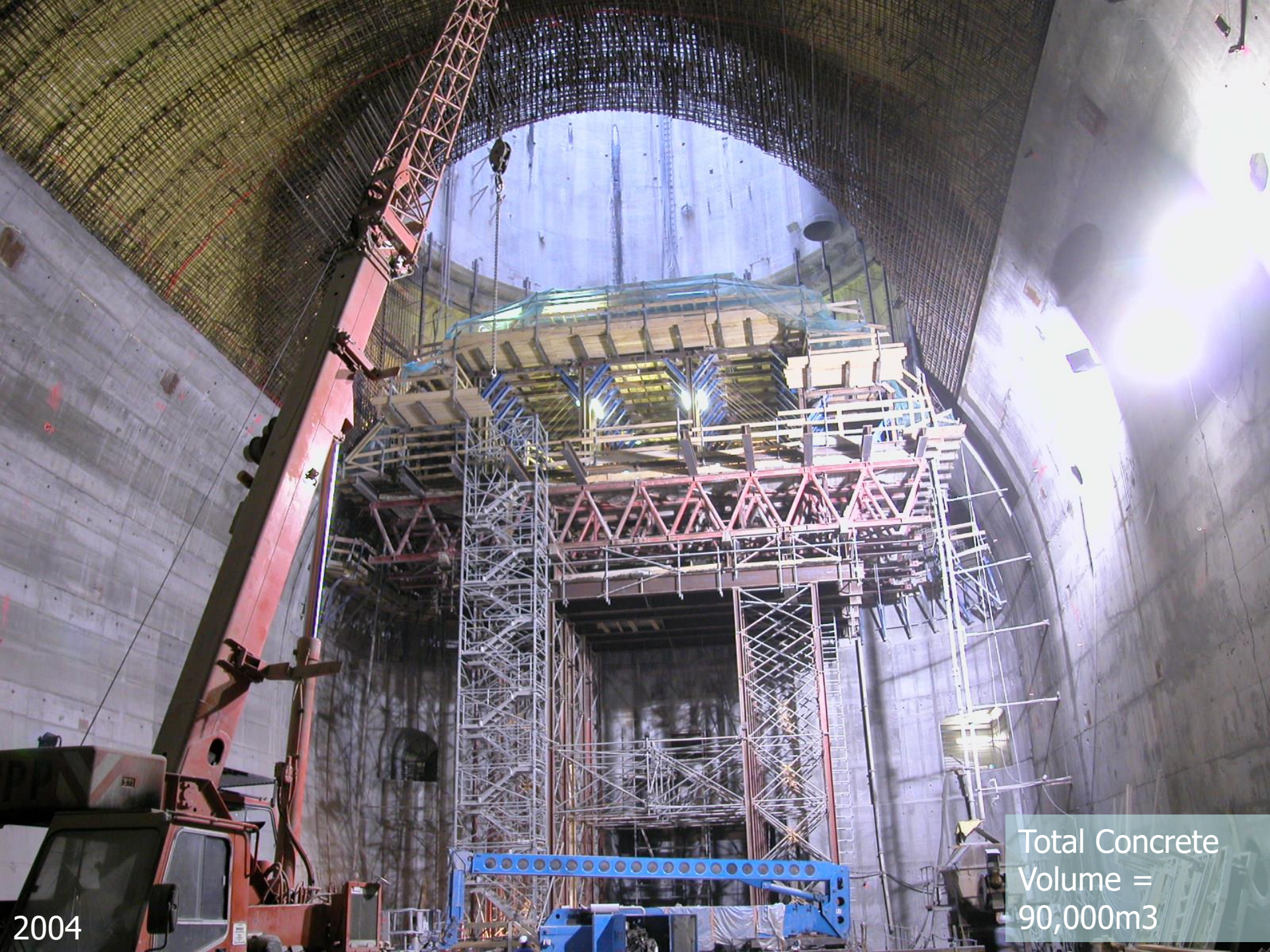

Total Concrete
Volume =
90,000m³

2004







Ray Veness (CERN)



ROSS
THE BOILER
ENGINEER

Image courtesy British Gas

CERN Staff by job description

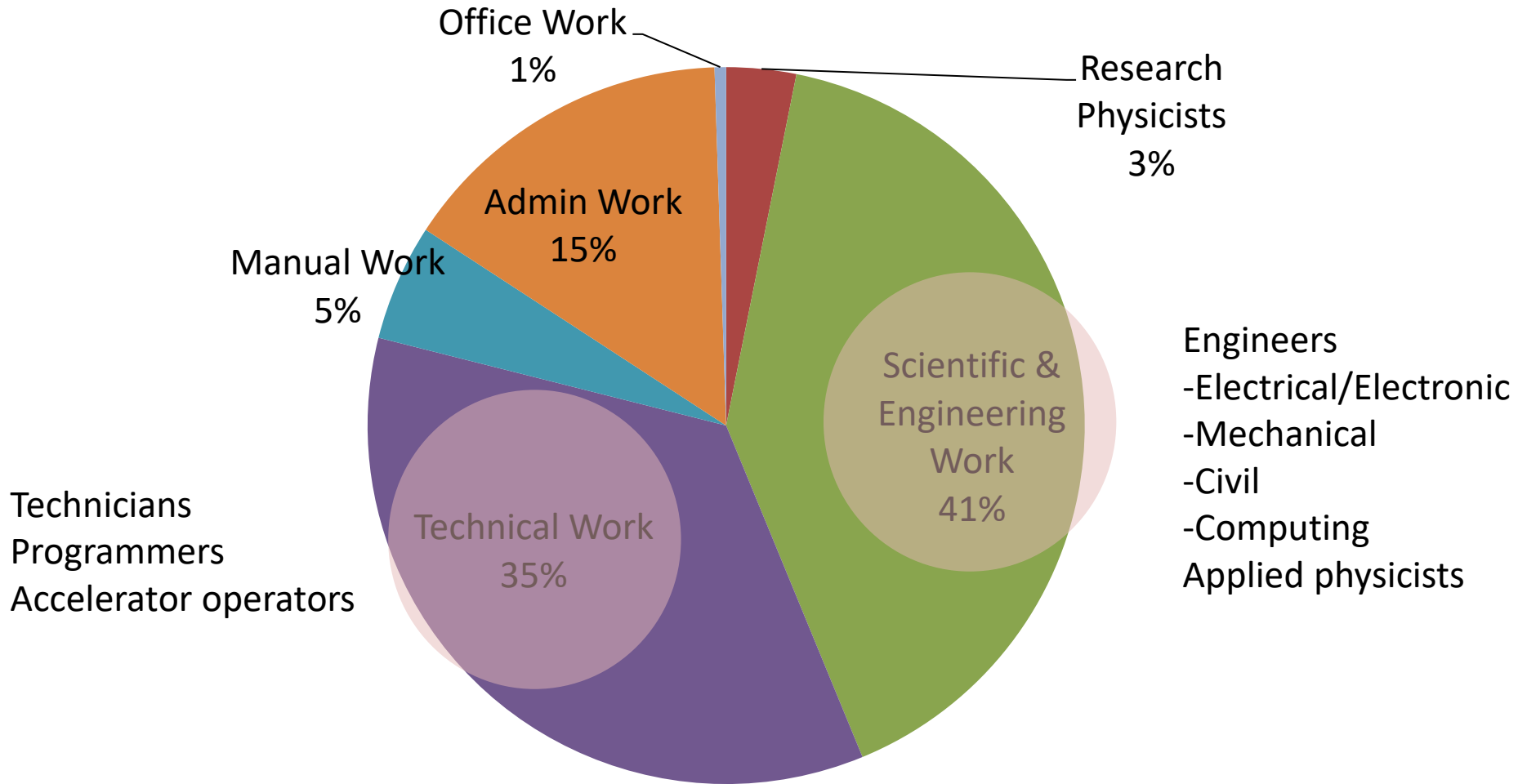

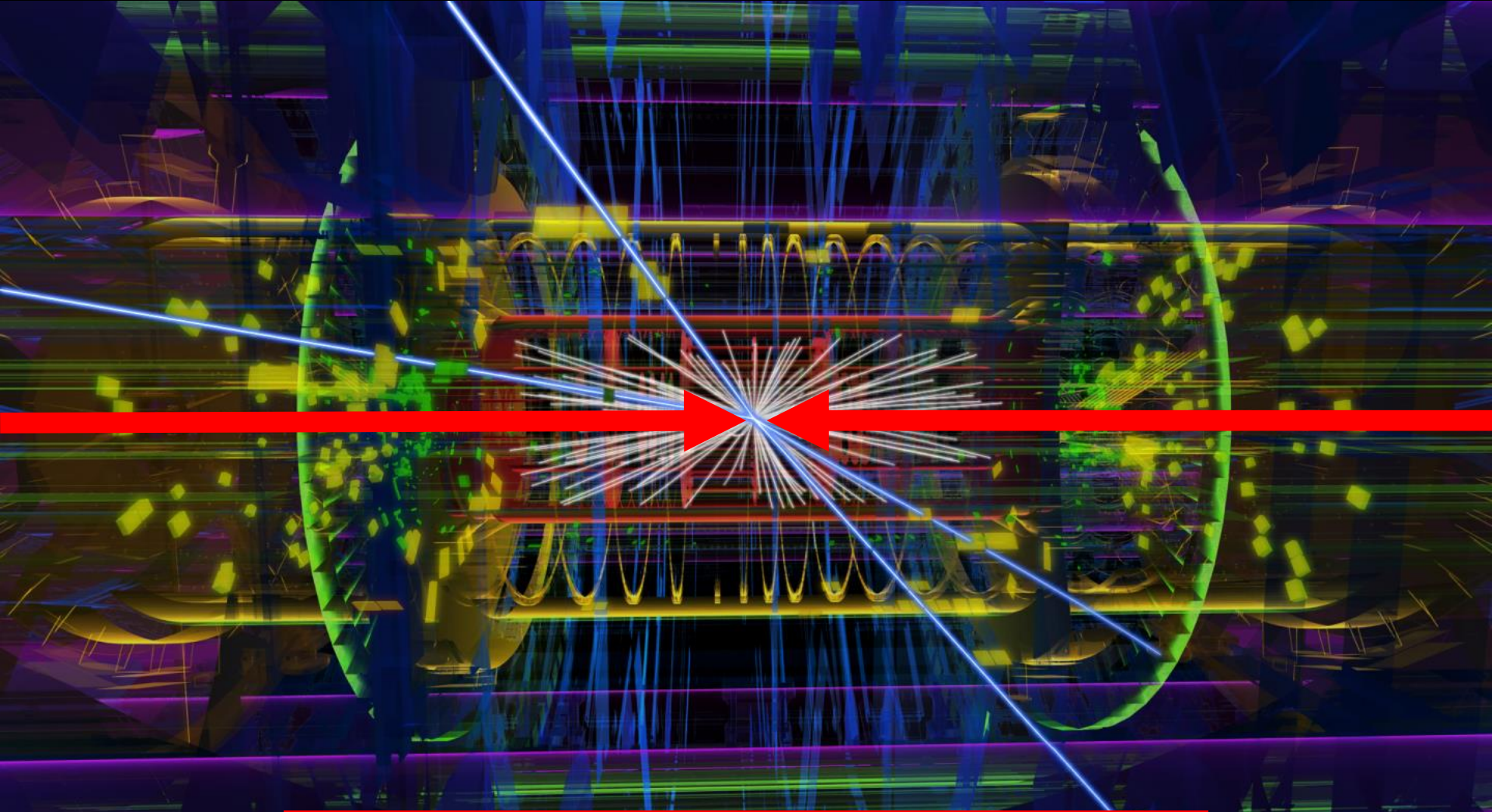

Physics specification for an experimental beampipe :
Nothing, contained by nothing!

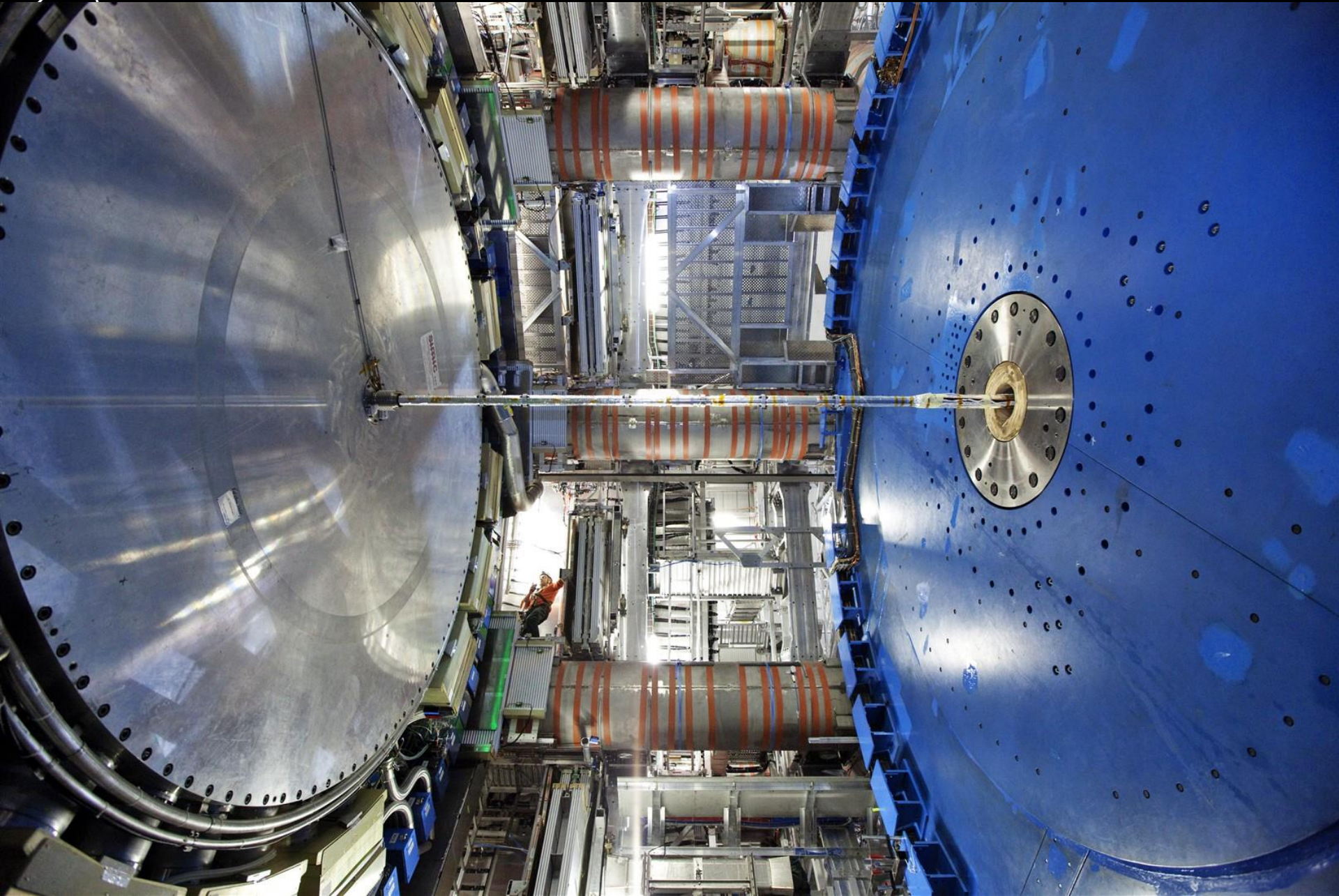



Nothing, contained by nothing!

Hydrogen is a gas at room temperature!

So is helium...

Lithium explodes in air... not so good

Beryllium... that would be good!

...except that it is pretty hard to get hold of!

Periodic Table of the Elements

1	2											10																						
3	4	5	6	7	8	9	10											18																
11	12	13	14	15	16	17	18	19	20	21	22	23	24	25	26	27	28	29	30	31	32	33	34	35	36									
37	38	39	40	41	42	43	44	45	46	47	48	49	50	51	52	53	54	55	56	57	58	59	60	61	62	63	64	65	66	67	68	69	70	71
72	73	74	75	76	77	78	79	80	81	82	83	84	85	86	87	88	89	90	91	92	93	94	95	96	97	98	99	100	101	102	103			
91	92	93	94	95	96	97	98	99	100	101	102	103	104	105	106	107	108	109	110	111	112	113												

* Lanthanide Series
 + Actinide Series

Beryllium metal is only really produced here in the USA...

...and here in Moscow.

And the only places in the world that make these kind of complex parts are here in California...

... and here in Kazakhstan...

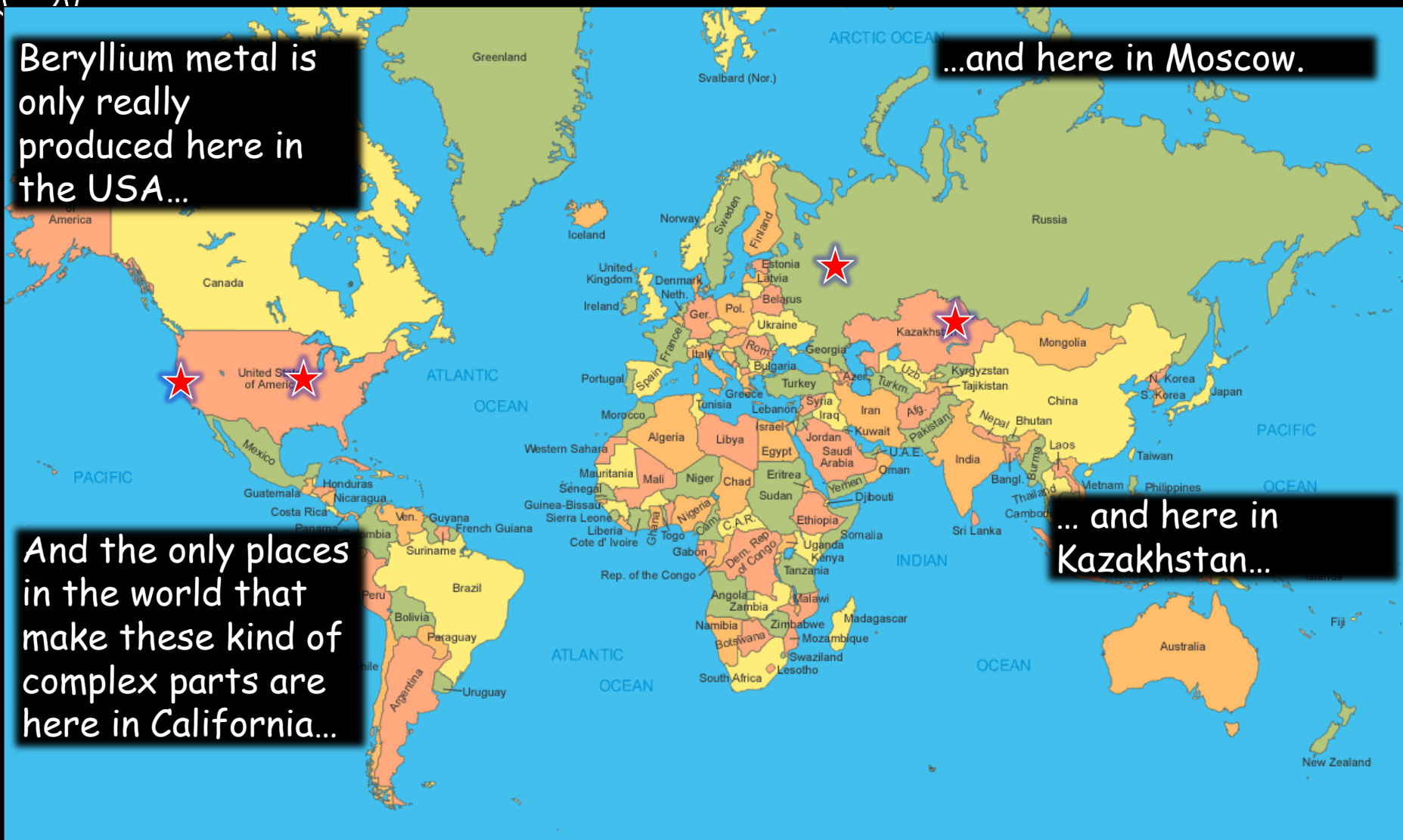



A photo I took of a CERN colleague, as we waited to cross the Khasakh-Russian border in 2004...

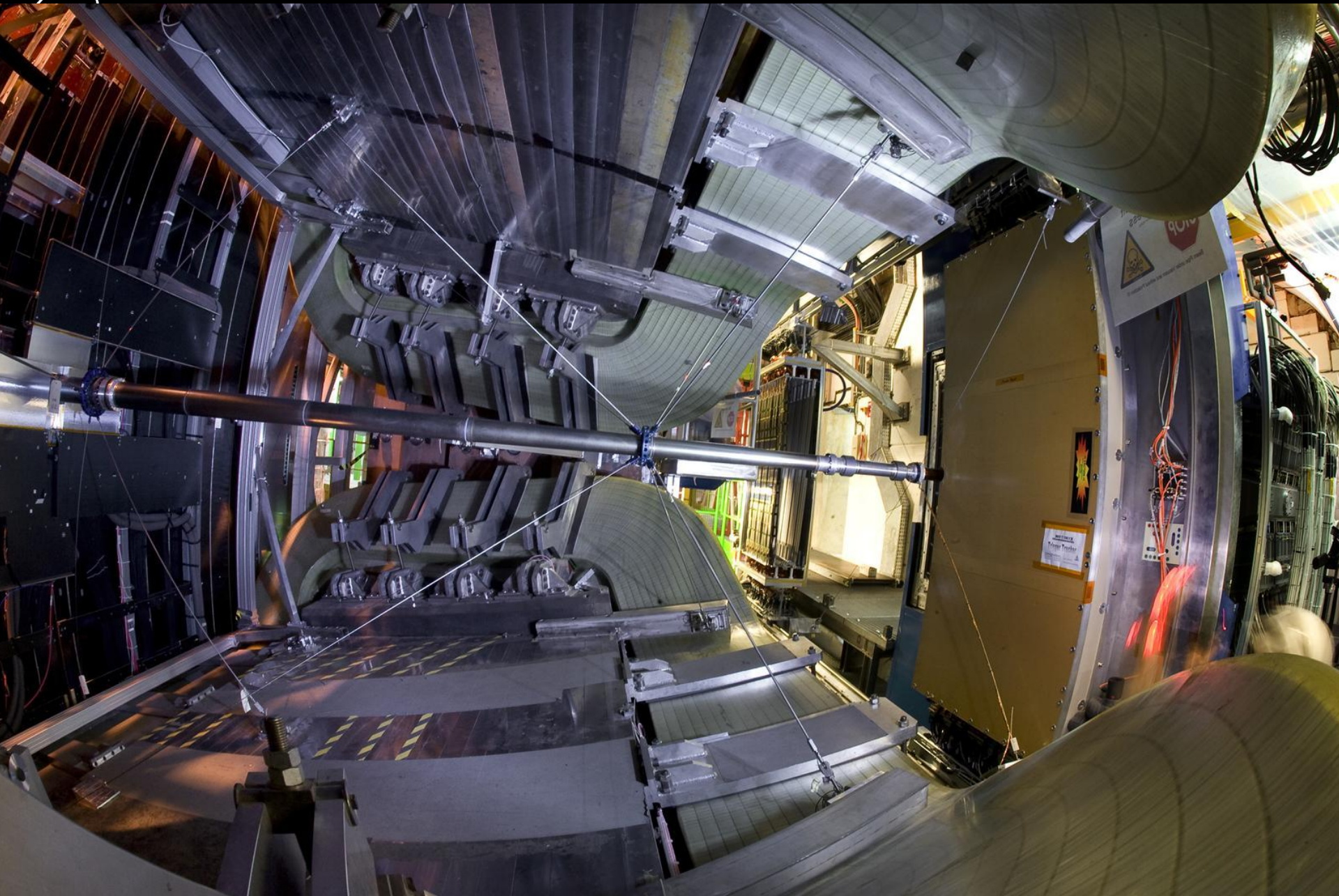

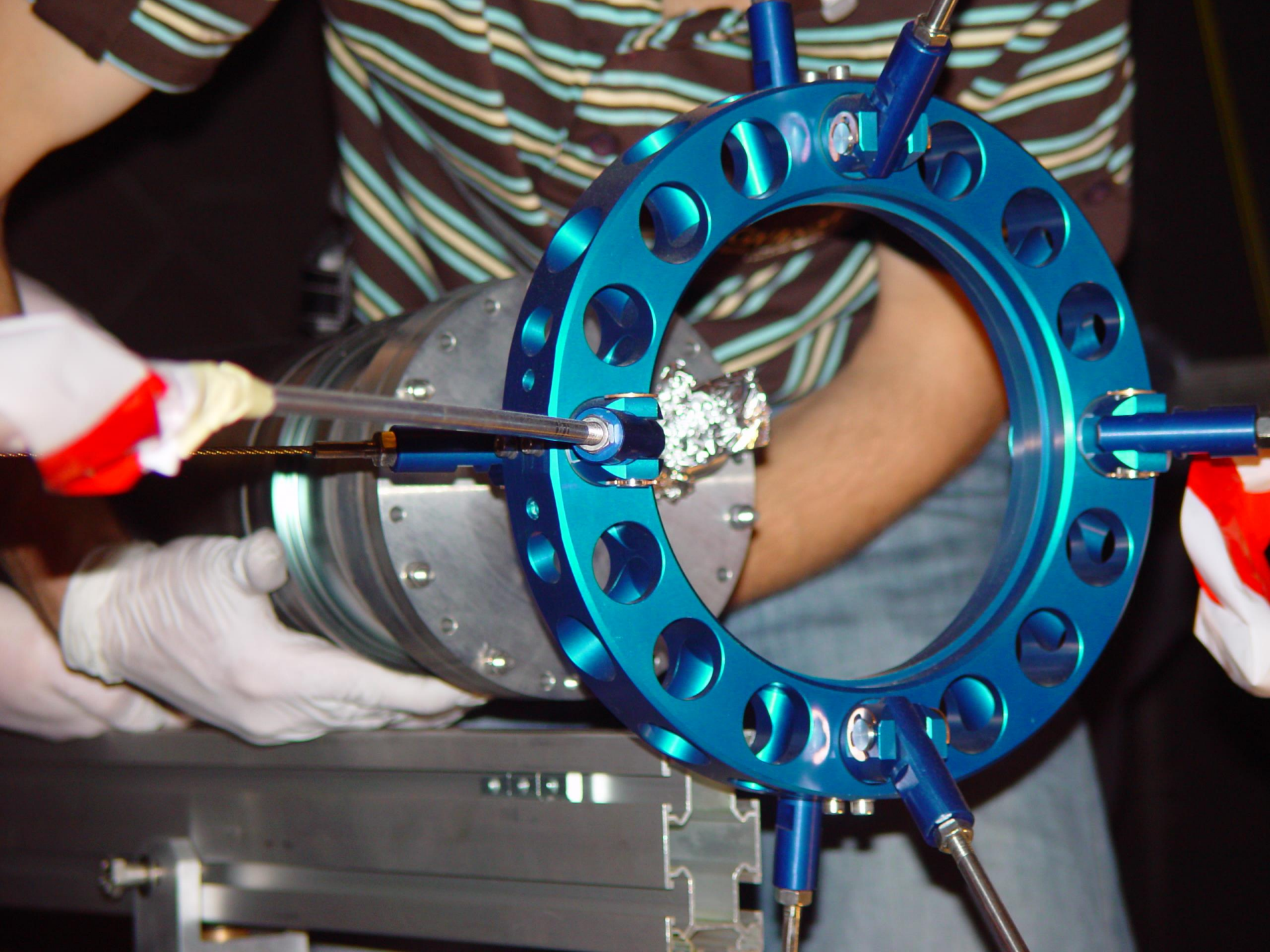



Engineering at CERN



Ray Veness (CERN)



One slide on some of my more recent projects

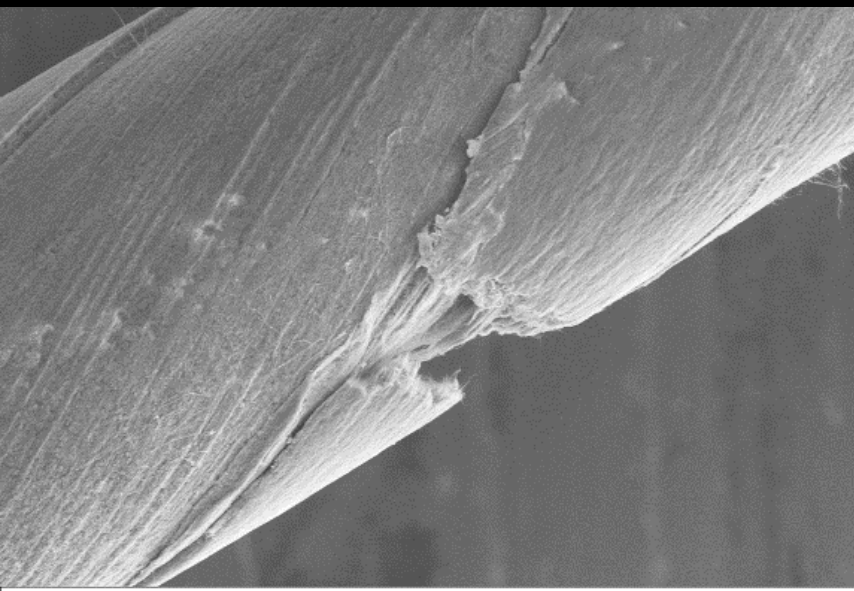

20 μm | EHT = 10.00 kV | Sample ID = | Date :12 Oct 2017 |
WD = 17.5 mm | Signal A = InLens | Mag = 628 X

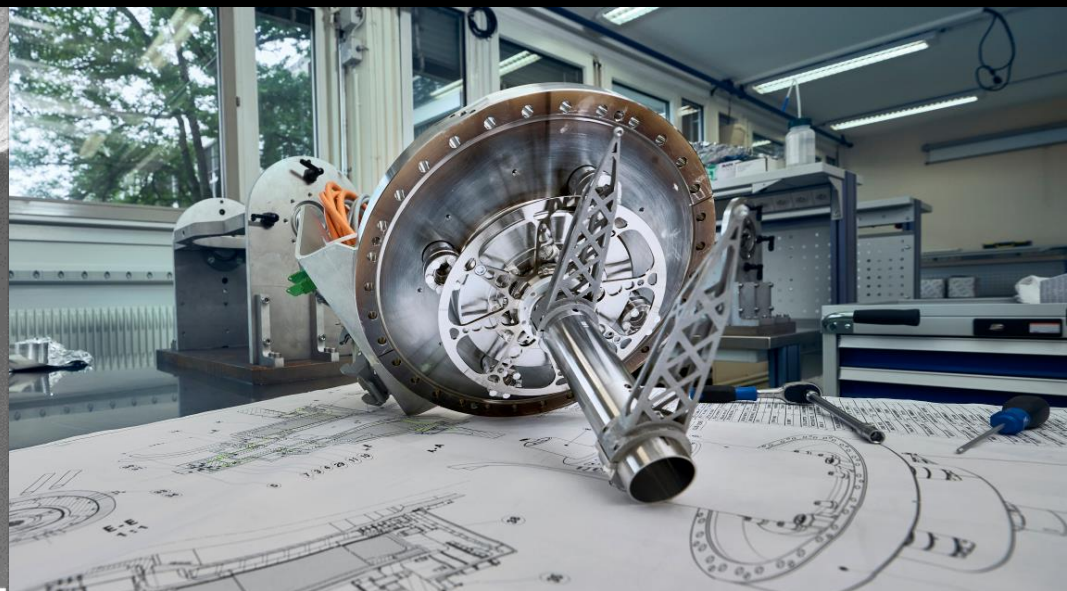



Engineering is about people

Technician (France)

Technician (Portugal)

Technical Engineer (France)

Engineer (Poland)

Engineer (Germany)

Technician (UK)

Engineer (UK)

Technical Engineer (Italy)

Engineer (Spain)

Mechanic (France)

Designer (UK)

Trainee (Italy)

Technician (France)

Doctoral Student (France)

Missing: Engineer (Pakistan); Technician (Swiss);
Engineer (Russia); Engineer (Ukraine)...



Beam Instrumentation Mechanics Section BBQ, June 2023



ROSS
THE BOILER
ENGINEER

Cooling and
ventilation technician

“...It’s my job to install your boiler and help with any boiler problems you may have...”



What is Engineering?

Oxford English Dictionary, 3rd Ed.

*The branch of science and technology concerned with the **development and modification of engines** (in various senses), **machines, structures, or other complicated systems and processes using specialized knowledge or skills, typically for public or commercial use...***

Wikipedia

(from Latin ingenium, meaning "cleverness" and ingeniare, meaning "to contrive, devise") is *the application of scientific, economic, social, and practical knowledge in order to invent, design, build, maintain, research, and improve structures, machines, devices, systems, materials and processes.*



So engineering means...

- **Make something real out of dreams**
 - Creativity!
- **Discussion, negotiation, consensus:**
 - Communication! Teamwork!
- **Need to be ready for lifelong learning:**
 - particle and accelerator physics, material science, leadership, commerce, Russian...
- **Based, of course, on good science:**
 - Start from first principles
 - But don't re-invent the wheel... unless you need to!
 - Good engineering design
- **Get it done, on time and on budget!**



CERN

- **CERN is a particle physics facility**
 - But we employ very few particle physicists
 - Most theoretical and experimental scientists work for our member institutes
- **...but most of what we do is “Engineering”**
 - 2/3 of our staff are engineers, applied scientists or technicians
 - Work together, we can produce the most amazing, complex and beautiful things



...and can I just ask you

- You are seeing some great examples of engineering
 - CMS Service cavern, Data centre,
 - SM18, AD/LEIR
- Give (all of) your students a different impression of what a career in engineering might mean
 - CERN, along with the economies of all our countries, needs more engineers, and diversity is as essential here, as everywhere



Thank you!

...and please feel free to
take some of our
enthusiasm for engineering
home with you!

Backup



Ray Veness, in a nutshell

- Born and schooled in London, England
- Studied Mechanical Engineering at Leicester University
 - PhD in Solid Mechanics at Leicester University
- 2 years working on fusion energy technology at Culham Laboratory, Oxfordshire, UK
- Recruited as a CERN staff in 1992
 - Worked as a Section Leader in 5 different departments
- Responsible for many parts of the LHC design, including all experimental vacuum systems
 - Co-author of the ATLAS Higgs discovery publication(!)
- Currently Section Leader and Deputy Group Leader for Beam Instrumentation (Accelerator Systems Department)

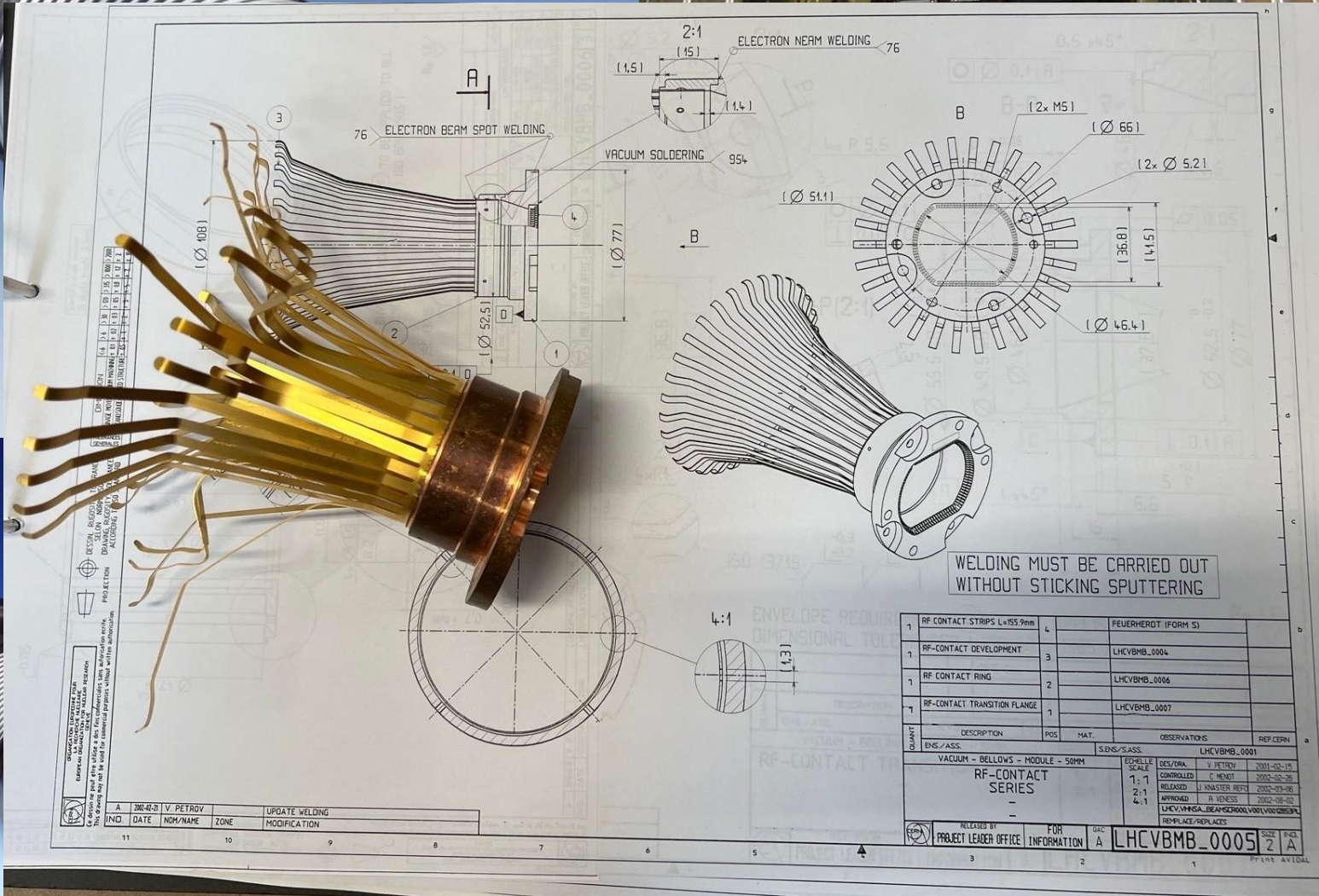
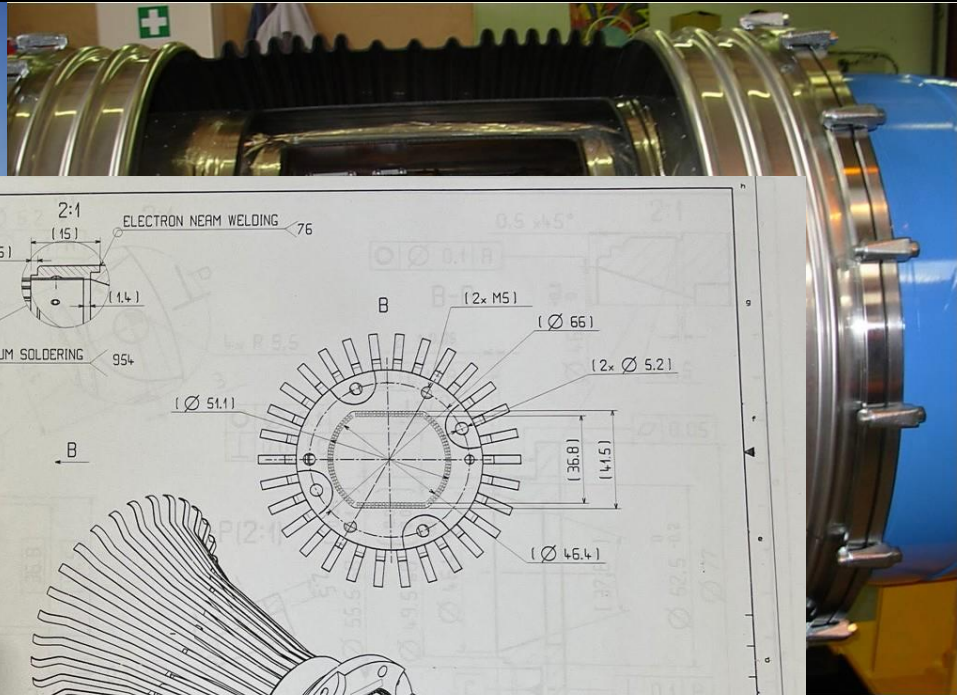

NO.	DATE	NOV/NAME	ZONE	MODIFICATION
1	2002-02-28	V. PETROV		UPDATE WELDING

NO.	DATE	NOV/NAME	ZONE	MODIFICATION
1	2002-02-28	V. PETROV		UPDATE WELDING

QTY	DESCRIPTION	POS.	MAT.	OBSERVATIONS	REF. CERN
1	RF CONTACT STRIPS L=155.9mm	4		FEUERHERDT (FORM 5)	
1	RF-CONTACT DEVELOPMENT	3		LHCVBMB_0004	
1	RF CONTACT RING	2		LHCVBMB_0006	
1	RF-CONTACT TRANSITION FLANGE	1		LHCVBMB_0007	

ENG./ASS.	SING./S.ASS.	DES./DRA.	SCALE	CONTROLLED	RELEASED	APPROVED	NO. OF PLACES / REPLACES
		V. PETROV	1:1	C. MENETI		R. VENESS	

RELEASED BY	FOR INFORMATION	DWG. NO.	SIZE	PROJ. NO.
PROJECT LEADER OFFICE		LHCVBMB_0005	A2	



First observations of a new particle in the search for the Standard Model Higgs boson at the LHC

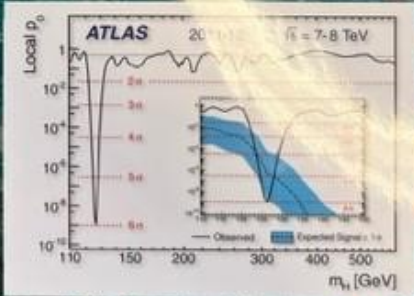
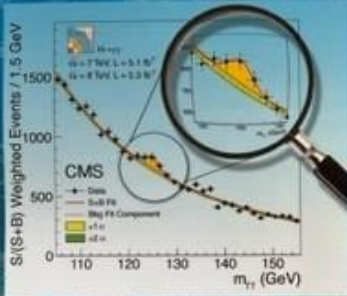

www.elsevier.com/locate/physletb

ATLAS Collaboration / *Physics Letters B* 714 (2012) 1–29

K. Taniguchi⁶⁶, N. Tannoury⁸³, S. Tapprogge⁸¹, D. Tardif¹⁵⁸, S. Tarem¹⁵², F. Tarrade⁷⁶, G.E. Tartarelli^{80a}, P. Tass¹²⁶, M. Tasevsky¹²⁵, E. Tassi^{374,376}, M. Tatarikhov¹⁵, Y. Tayalati^{135d}, C. Taylor⁷⁷, E.E. Taylor⁹², G.N. Taylor⁸⁶, W. Taylor^{150b}, M. Teinturier¹³⁵, F.A. Teischinger³⁰, M. Teixeira Dias Castanheira⁷⁵, P. Teixeira-Dias⁷⁶, K.K. Temming⁴⁸, H. Ten Kate³⁰, P.K. Teng¹⁵¹, S. Terada⁶⁵, K. Terashi¹⁵⁵, J. Terron⁸⁰, M. Testa⁴⁷, R.J. Teuscher^{158,4}, J. Therhaag²¹, T. Theveneaux-Pelzer⁷⁸, S. Thoma⁴⁸, J.P. Thomas¹⁸, E.N. Thompson⁴⁵, P.D. Thompson¹⁵⁸, A.S. Thompson¹⁵⁸, S. Thoma⁴⁸, J.P. Thomas¹⁸, E. Thomson¹²⁰, M. Thomson²⁹, W.M. Thong⁸⁶, R.P. Thun⁸⁷, F. Tian²⁵, M.J. Tibbets¹⁵, T. Tic¹²⁵, V.O. Tikhomirov⁹⁴, Y.A. Tikhonov¹⁰⁷, S. Timoshenko⁸⁶, E. Tlouschichine⁸¹, P. Tipton¹⁷⁶, S. Tisserant⁸³, T. Todorov⁵, S. Todorova-Nova¹⁶¹, B. Toggerson¹⁶³, J. Tojo⁶⁹, S. Tokár^{144a}, K. Tokushuku⁶⁵, K. Tollefson⁸⁸, M. Tomoto¹⁰¹, L. Tompkins³¹, K. Toms¹⁰³, A. Tonoyan¹⁴, C. Topfel¹⁷, N.D. Topilin⁶⁴, I. Torchiani²⁰, E. Torrence¹¹⁴, H. Torres⁷⁸, E. Torró Pastor¹⁶⁷, J. Toth^{83,4f}, F. Touchard⁸³, D.R. Tovey¹³⁹, T. Trefzger¹⁷⁴, L. Tremblet³⁰, A. Tricoli³⁰, I.M. Trigger^{159a}, G. Trilling¹⁵⁸, S. Trincav-Duvioz⁷⁸, M.F. Triplana⁷⁰, N. Triplett²⁵, W. Trischuk¹⁵⁸, B. Trocme⁵⁵, C. Troncon^{89a}, M. Trotter-McDonald¹⁴², M. Trzebinski³⁹, A. Trzupek³⁹, C. Tsarouchas³⁰, J.C.-L. Tseng¹¹⁸, M. Tsiakiris¹⁰⁵, P.V. Tsiarehka⁹⁰, D. Tsiionou^{5,4f}, G. Tsipolitis¹⁰, S. Tsiskaridze¹², V. Tsiskaridze⁴⁸, E.G. Tskhadadze^{51a}, I.I. Tsukerman⁹⁵, V. Tsaluaia¹⁵, J.-W. Tsung²¹, S. Tsuno⁶⁵, D. Tsybychev¹⁴⁸, A. Tua¹³⁹, A. Tudorache^{26a}, V. Tudorache^{16a}, J.M. Tuggle³¹, M. Turala¹⁹, D. Turecek¹²⁷, I. Turk Cakir⁴⁶, E. Turley¹⁰⁵, R. Turra^{89a,89b}, P.M. Tuts³⁵, M. Ujland¹⁴, M. Uhlenbrock²¹, M. Uhrmacher⁵⁴, F. Ukegawa¹⁶⁰, G. Unal³⁰, A. Undrus²⁵, G. Unel¹⁶³, Y. Uno⁶⁵, D. Urbaniec³⁵, P. Urquijo²¹, G. Usai⁸, M. Uslenghi^{119a,119b}, L. Vacavac⁸³, V. Vacek¹²⁷, B. Vachon⁸⁵, S. Vahsen¹⁵, J. Valenta¹²⁵, S. Valentini^{20a,20b}, A. Valero¹⁶⁷, S. Valkar¹²⁶, E. Valladolid Gallego¹⁶⁷, S. Vallecorsa¹⁵², J.A. Valls Ferrer¹⁶⁷, R. Van Berg¹²⁰, P.C. Van Der Deijl¹⁰⁵, R. van der Geer¹⁰⁵, H. van der Graaf¹⁰⁵, R. Van Der Leeuw¹⁰⁵, E. van der Poel¹⁰⁵, D. van der Ster⁷⁰, N. van Eldik¹⁰, P. van Gemmeren⁶, I. van Vulpen¹⁰⁵, M. Vanadia⁹⁹, W. Vandelli³⁰, R. Vanguri¹²⁰, A. Vaniachine⁹, P. Vankov⁴², F. Vannucci⁷⁸, R. Varji^{132a}, T. Varol⁸⁴, D. Varouchas¹⁵, A. Vartapetian⁸, K.E. Varvell¹⁵⁰, V.I. Vassilikopoulos⁵⁶, F. Vazeille³⁴, T. Vazquez Schroeder²⁴, G. Vegni^{89a,89b}, J.J. Veillet¹¹⁵, F. Veloso^{124,4}, R. Veness³⁰, S. Veneziano^{132a}, A. Ventura^{72a,72b}, D. Ventura⁸⁴, M. Venturi⁴⁸, N. Venturi¹⁵⁸, V. Vercesi^{119a}, M. Verducci¹³⁸, W. Verkerke¹⁰⁵, J.C. Vermeulen¹⁰⁵, A. Vest⁴⁴, M.C. Vetterli^{142,4f}, I. Vichou¹⁶⁵, T. Vickey^{145b,4f}, O.E. Vickey Boeriu^{145b}, G.H.A. Viehhauser¹¹⁸, S. Viel¹⁶⁸, M. Villa^{20a,20b}, M. Villaplana Perez¹⁶⁷, E. Vilucchi⁴⁷, M.G. Vincter²⁹, E. Vinek³⁰, V.B. Vinogradov⁶⁴, M. Virchaux^{136,4}, J. Virzi¹⁵, O. Vitells¹⁷², M. Viti⁴², I. Vivarelli⁴⁸, E. Vives Vague³, S. Vlachos¹⁰, D. Vladouir⁹⁸, M. Vlasak¹²⁷, A. Vogel²¹, P. Vokac¹²⁷, G. Volpi⁴⁷, M. Volpi⁸⁹, G. Volpini^{89a}, H. von der Schmitt⁹⁹, H. von Radziewski⁴⁸, E. von Toerne²¹, V. Vorobel¹²⁸, V. Vorwerk¹², M. Vos¹⁶⁷, R. Voss³⁰, T.T. Voss¹⁷⁵, J.H. Vosseveld⁷³, N. Vranjes¹³⁶, M. Vranjes Milosavljevic¹⁰⁵, V. Vrba¹²⁵, M. Vreeswijk¹⁰⁵, T. Vu Anh⁴⁸, R. Vuillermet³⁰, I. Vukotic³¹, W. Wagner¹⁷⁵, P. Wagner¹²⁰, H. Wahlen¹⁷⁵, S. Wahrmund⁴⁴, J. Wakabayashi¹⁰¹, S. Walch⁸⁷, J. Walder⁷¹, R. Walker⁹⁸, W. Walkowiak¹⁴¹, R. Wall¹⁷⁶, P. Waller⁷³, B. Walsh¹⁷⁶, C. Wang⁴⁵, F. Wang¹⁷³, H. Wang¹⁷³, H. Wang^{20b,4k}, J. Wang¹⁵¹, J. Wang⁵⁵, R. Wang¹⁰³, S.M. Wang¹⁵¹, T. Wang²¹, A. Warburton⁸⁵, C.P. Ward²⁸, D.R. Wardrope⁷⁹, M. Warsinsky⁴⁸, A. Washbrook⁴⁶, C. Wasicki⁴², I. Watanabe⁶⁶, P.M. Watkins¹⁸, A.T. Watson¹⁸, I.J. Watson¹⁵⁰, M.P. Watson¹⁸, G. Watts¹³⁸, S. Watts⁸², A.T. Waugh¹⁵⁰, B.M. Waugh⁷⁷, M.S. Weber¹⁷, P. Weber⁵⁴, J.S. Webster³¹, A.R. Weidberg¹¹⁸, P. Weigell⁹⁰, J. Weingarten³⁴, C. Weiser⁴⁸, P.S. Wells³⁰, T. Wenaus²⁵, D. Wendland¹⁶, Z. Weng^{151,4f}, T. Wengler³⁰, S. Wenig²⁰, N. Wermes²⁵, S.J. Wheeler-Ellis¹⁶³, A. White⁸, M. Werth¹⁶³, M. Wessels^{58a}, J. Wetter¹⁶¹, C. Weydert⁹⁵, K. Whalen²⁹, S.J. Wheeler-Ellis¹⁶³, A. White⁸, M.J. White⁸⁶, S. White^{122a,122b}, S.R. Whitehead¹¹⁸, D. Whiteson¹⁶³, D. Whittington⁶⁰, F. Wick¹¹⁵, D. Wicke¹⁷⁵, F.J. Wickens¹²⁹, W. Wiedenmann¹⁷³, M. Wieler¹²⁹, P. Wienemann²¹, C. Wiglesworth⁷⁵, L.A.M. Wiik-Fuchs⁴⁸, P.A. Wijeratne⁷⁷, A. Wildauer⁹⁹, M.A. Wildt^{42,4f}, I. Wilhelm¹²⁶, H.G. Wilkens³⁰, J.Z. Will⁹⁸, E. Williams³⁵, H.H. Williams¹²⁰, W. Willis³⁵, S. Willcoq⁸⁴, J.A. Wilson¹⁸, M.G. Wilson¹⁴³, A. Wilson⁸⁷, I. Wingter-Seez⁵, S. Winkelmann⁴⁸, F. Winklmeier³⁰, M. Wittgen¹⁴³, S.J. Wollstadt⁸¹, M.W. Wolter³⁹, H. Wolters^{124,4h}, W.C. Wong⁴¹, G. Wooden⁸⁷, B.K. Wosiek³⁹, J. Wotschack³⁰, M.J. Woudstra⁴², K.W. Wozniak³⁰, K. Wraight⁵³, M. Wright⁵³, B. Wrona⁷³, S.L. Wu¹⁷³, X. Wu⁴⁹, Y. Wu^{33b,4f}, E. Wulf³⁵, B.M. Wynne⁴⁶, S. Xella³⁶, M. Xiao¹³⁶, S. Xie⁴⁸, C. Xu^{33b,4}, D. Xu¹³⁹, B. Yabsley¹⁵⁰, S. Yacoub^{145a,4m}, M. Yamada⁶⁵, H. Yamaguchi¹⁵⁵, Y. Yamaguchi¹⁵⁵, A. Yamamoto⁶⁵