

---

# Lecture 1

## Introduction to Particle Accelerators

Professor Emmanuel Tsesmelis  
Principal Physicist, CERN  
Visiting Professor, University of Oxford

Graduate Accelerator Physics Course  
John Adams Institute for Accelerator Science  
12 October 2022



---

# JAI Graduate Accelerator Physics Course

- Delivered over **two Academic Terms**
  - **Term I** (Michaelmas Term 2022)
    - 24 lectures and 6 tutorials
    - First three lectures and first tutorial includes Oxford PP students.
  - **Term II** (Hilary Term 2023)
    - Lectures, tutorials and design project
- **Course site** is <https://indico.cern.ch/category/5869/>
  - Includes all lecture / tutorial material, videoconference connection, student handbook etc.
- **Videoconference facility** for remote connection
- Contact Sue Geddes ([sue.geddes@physics.ox.ac.uk](mailto:sue.geddes@physics.ox.ac.uk)) for **accommodation** in Oxford college

**Contact e-mail: [Emmanuel.Tsesmelis@cern.ch](mailto:Emmanuel.Tsesmelis@cern.ch)**

---

# Introduction



# Accelerator Development

- Characterised by rapid progress for over a century.
  - From cathode-ray tubes to the LHC.
  - From the discovery of the electron to the discovery of the Higgs boson.
- Advances in accelerators require corresponding advances in accelerator technologies
  - Magnets, vacuum systems, RF systems, diagnostics,...
- But timelines becoming long, requiring:
  - Long-term planning.
  - Long-term resources.
  - Global collaboration.

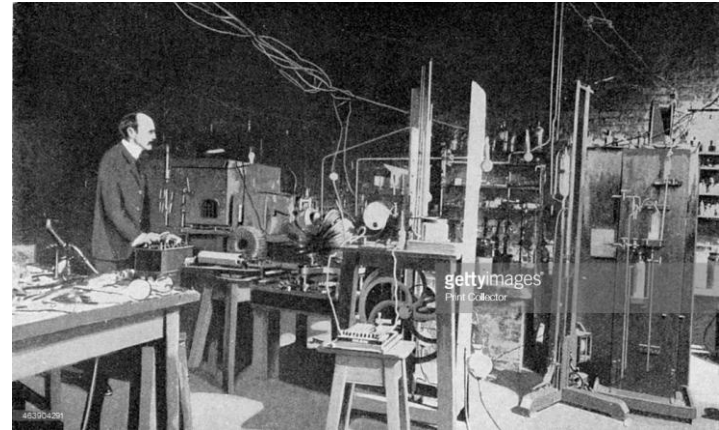

# 24 (+1) Nobel Prizes in Physics that had direct contribution from accelerators

Year	Name	Accelerator-Science Contribution to Nobel Prize-Winning Research
1939	Ernest O. Lawrence	Lawrence invented the cyclotron at the University of Californian at Berkeley in 1929 [12].
1951	John D. Cockroft and Ernest T.S. Walton	Cockroft and Walton invented their eponymous linear positive-ion accelerator at the Cavendish Laboratory in Cambridge, England, in 1932 [13].
1952	Felix Bloch	Bloch used a cyclotron at the Crocker Radiation Laboratory at the University of California at Berkeley in his discovery of the magnetic moment of the neutron in 1940 [14].
1957	Tsung-Dao Lee and Chen Ning Yang	Lee and Yang analyzed data on K mesons ( $\theta$ and $\tau$ ) from Bevatron experiments at the Lawrence Radiation Laboratory in 1955 [15], which supported their idea in 1956 that parity is not conserved in weak interactions [16].
1959	Emilio G. Segrè and Owen Chamberlain	Segrè and Chamberlain discovered the antiproton in 1955 using the Bevatron at the Lawrence Radiation Laboratory [17].
1960	Donald A. Glaser	Glaser tested his first experimental six-inch bubble chamber in 1955 with high-energy protons produced by the Brookhaven Cosmotron [18].
1961	Robert Hofstadter	Hofstadter carried out electron-scattering experiments on carbon-12 and oxygen-16 in 1959 using the SLAC linac and thereby made discoveries on the structure of nucleons [19].
1963	Maria Goeppert Mayer	Goeppert Mayer analyzed experiments using neutron beams produced by the University of Chicago cyclotron in 1947 to measure the nuclear binding energies of krypton and xenon [20], which led to her discoveries on high magic numbers in 1948 [21].
1967	Hans A. Bethe	Bethe analyzed nuclear reactions involving accelerated protons and other nuclei whereby he discovered in 1939 how energy is produced in stars [22].
1968	Luis W. Alvarez	Alvarez discovered a large number of resonance states using his fifteen-inch hydrogen bubble chamber and high-energy proton beams from the Bevatron at the Lawrence Radiation Laboratory [23].
1976	Burton Richter and Samuel C.C. Ting	Richter discovered the $J/\psi$ particle in 1974 using the SPEAR collider at Stanford [24], and Ting discovered the $J/\psi$ particle independently in 1974 using the Brookhaven Alternating Gradient Synchrotron [25].
1979	Sheldon L. Glashow, Abdus Salam, and Steven Weinberg	Glashow, Salam, and Weinberg cited experiments on the bombardment of nuclei with neutrinos at CERN in 1973 [26] as confirmation of their prediction of weak neutral currents [27].
1980	James W. Cronin and Val L. Fitch	Cronin and Fitch concluded in 1964 that CP (charge-parity) symmetry is violated in the decay of neutral K mesons based upon their experiments using the Brookhaven Alternating Gradient Synchrotron [28].
1981	Kai M. Siegbahn	Siegbahn invented a weak-focusing principle for betatrons in 1944 with which he made significant improvements in high-resolution electron spectroscopy [29].
1983	William A. Fowler	Fowler collaborated on and analyzed accelerator-based experiments in 1958 [30], which he used to support his hypothesis on stellar-fusion processes in 1957 [31].
1984	Carlo Rubbia and Simon van der Meer	Rubbia led a team of physicists who observed the intermediate vector bosons W and Z in 1983 using CERN's proton-antiproton collider [32], and van der Meer developed much of the instrumentation needed for these experiments [33].
1986	Ernst Ruska	Ruska built the first electron microscope in 1933 based upon a magnetic optical system that provided large magnification [34].
1988	Leon M. Lederman, Melvin Schwartz, and Jack Steinberger	Lederman, Schwartz, and Steinberger discovered the muon neutrino in 1962 using Brookhaven's Alternating Gradient Synchrotron [35].
1989	Wolfgang Paul	Paul's idea in the early 1950s of building ion traps grew out of accelerator physics [36].
1990	Jerome I. Friedman, Henry W. Kendall, and Richard E. Taylor	Friedman, Kendall, and Taylor's experiments in 1974 on deep inelastic scattering of electrons on protons and bound neutrons used the SLAC linac [37].
1992	Georges Charpak	Charpak's development of multiwire proportional chambers in 1970 were made possible by accelerator-based testing at CERN [38].
1995	Martin L. Perl	Perl discovered the tau lepton in 1975 using Stanford's SPEAR collider [39].
2004	David J. Gross, Frank Wilczek, and H. David Politzer	Gross, Wilczek, and Politzer discovered asymptotic freedom in the theory of strong interactions in 1973 based upon results from the SLAC linac on electron-proton scattering [40].
2008	Makoto Kobayashi and Toshihide Maskawa	Kobayashi and Maskawa's theory of quark mixing in 1973 was confirmed by results from the KEKB accelerator at KEK (High Energy Accelerator Research Organization) in Tsukuba, Ibaraki Prefecture, Japan, and the PEP II (Positron Electron Project II) at SLAC [41], which showed that quark mixing in the six-quark model is the dominant source of broken symmetry [42].

A.Chao and E. Haussecker "*Impact of Accelerator Science on Physics Research*", published in ICFA Newsletter, Dec 2010; & submitted to the Physics in Perspective Journal, Dec 2010.

# Nobel Prize in Physics 2013



The Nobel Prize in Physics 2013 was awarded jointly to François Englert and Peter W. Higgs *"for the theoretical discovery of a mechanism that contributes to our understanding of the origin of mass of subatomic particles, and which recently was confirmed through the discovery of the predicted fundamental particle, by the ATLAS and CMS experiments at CERN's Large Hadron Collider"*.

# Livingston Plot

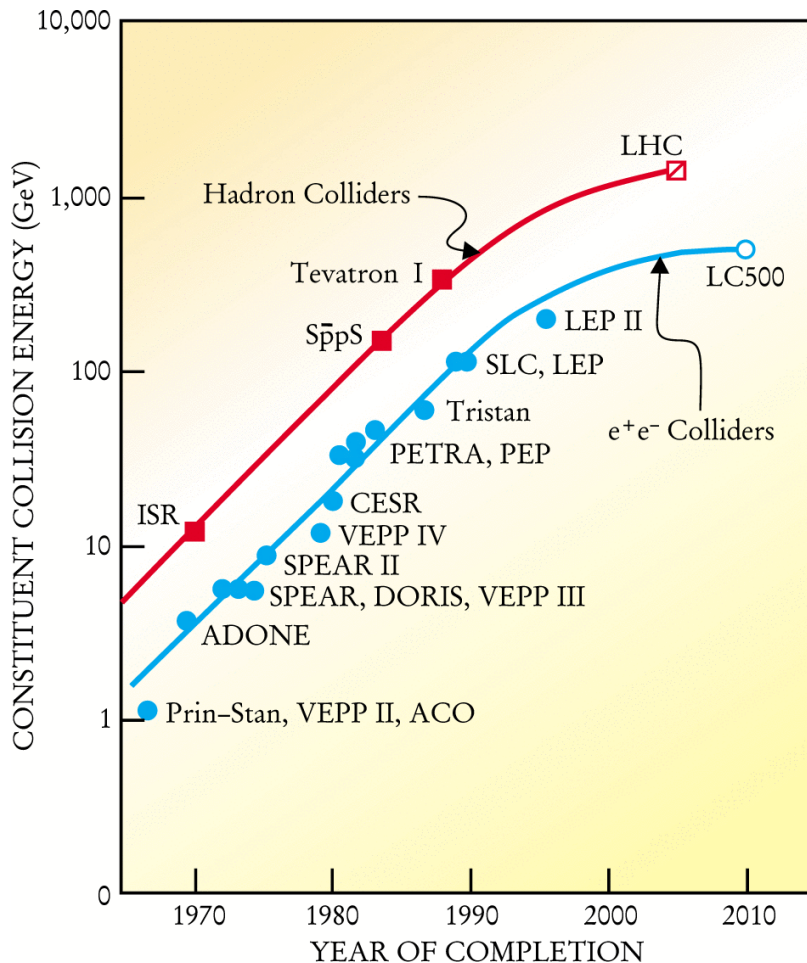

- Around 1950, Livingston made following observation:
  - Plotting energy of accelerator as a function of year of commissioning, on semi-log scale, the energy gain had linear dependence.
- Observations today:
  - Exhibition of saturation effect:
    - New technologies needed.
  - Overall project cost increased
    - Project cost increased by factor of 200 over last 40 years.
  - Cost per proton-proton  $E_{CM}$  energy decreased by factor of 10 over last 40 years.

# Rutherford fired the starting pistol

At the Royal Society  
in 1928 he said:

*“I have long hoped  
for a source of  
positive particles  
more energetic than  
those emitted from  
natural radioactive  
substances”.*

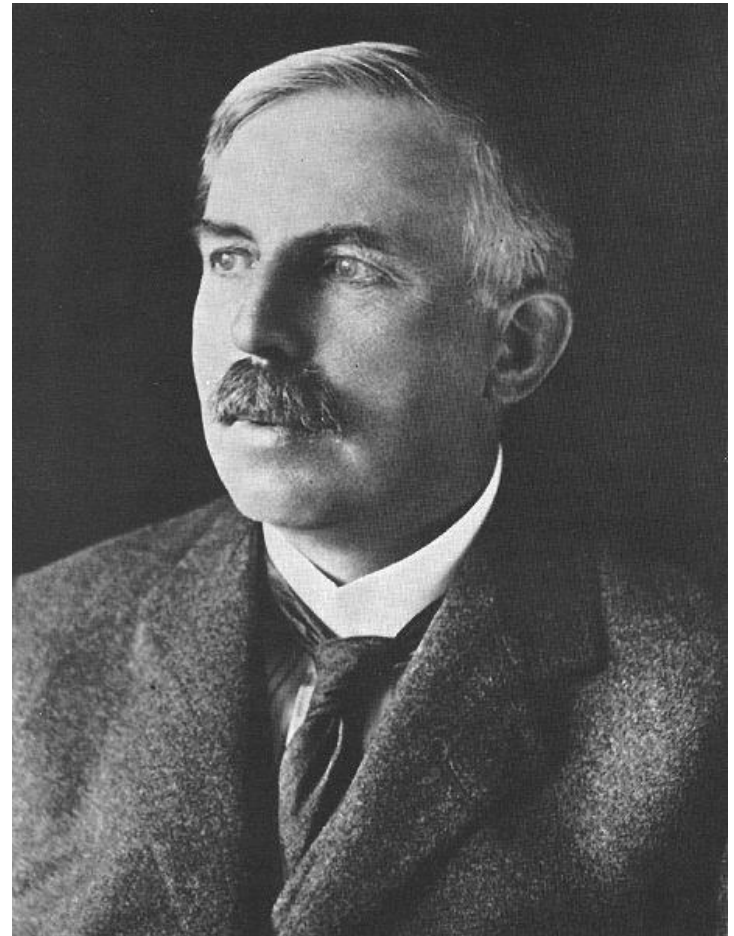



# Electrostatic Accelerators

## The Cockcroft-Walton

- Based on system of multiple rectifiers.
- Voltage generated by cascade circuit

$$U_{\text{tot}} = 2Un - \frac{2\pi I}{\omega C} \left( \frac{2}{3}n^3 + \frac{1}{4}n^2 + \frac{1}{12}n \right)$$

- Modern CWs
  - Voltages up to ~4 MV.
  - Beam currents of several hundred mA with pulsed particle beams of few  $\mu\text{s}$  pulse length.

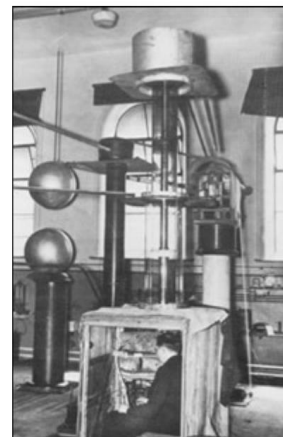
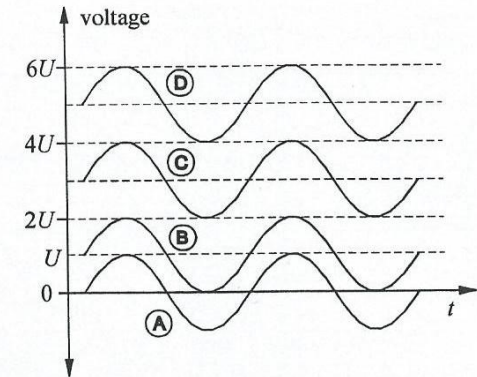
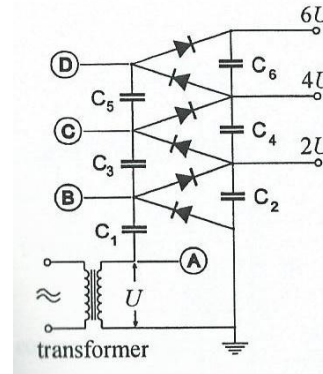

Walton and the machine used to "split the atom"  
Cavendish Lab, Cambridge

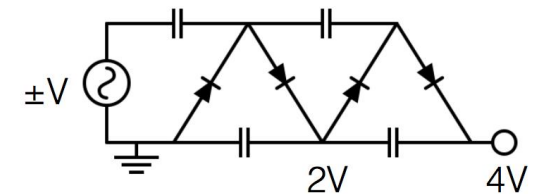

Voltage multiplier circuit

[https://www.youtube.com/watch?v=ep3D\\_LC2UzU](https://www.youtube.com/watch?v=ep3D_LC2UzU)

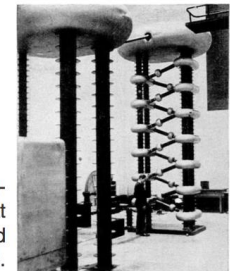

1.2 MV 6 stage Cockcroft-Walton accelerator at Clarendon Lab, Oxford University in 1948.

10

# Electrostatic Accelerators – The Van de Graaff

- With any electrostatic accelerator, it is difficult to achieve energy higher than ~20 MeV (e.g. due to practical limitations of the size of the vessels).

## Van de Graaff Generator

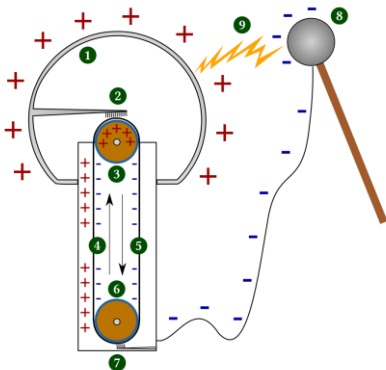

- hollow metal sphere
- upper electrode
- upper roller (for example an acrylic glass)
- side of the belt with positive charges
- opposite side of belt, with negative charges
- lower roller (metal)
- lower electrode (ground)
- spherical device with negative charges
- spark produced by the difference of potentials

## Robert Van de Graaff 1929

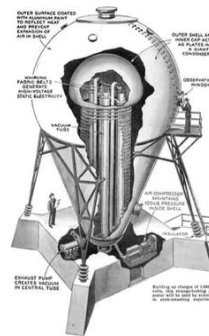

The Westinghouse atom smasher, 1937 11

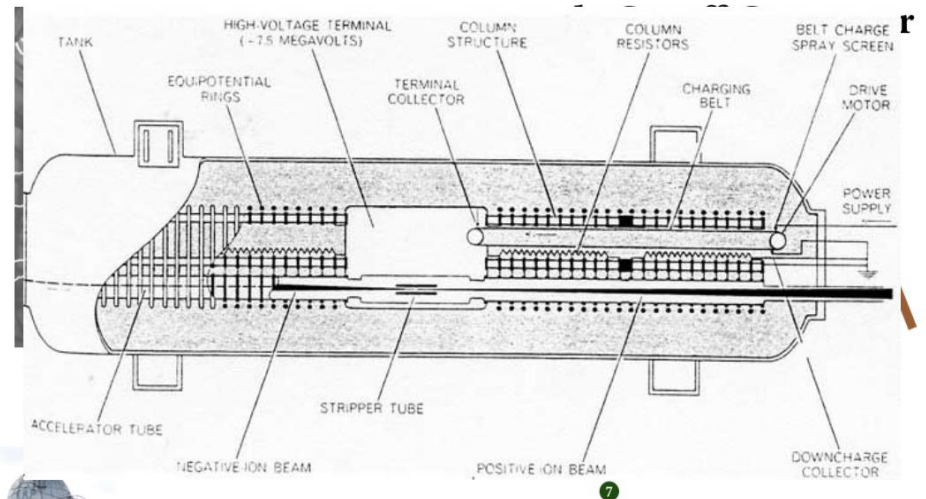

- hollow metal sphere
- upper electrode
- upper roller (for example an acrylic glass)
- side of the belt with positive charges
- opposite side of belt, with negative charges
- lower roller (metal)
- lower electrode (ground)
- spherical device with negative charges
- spark produced by the difference of potentials

"Van de Graaff Generator" by Omphaloskeptic - Own work. Licensed under CC BY-SA 3.0 via Commons

# Linear Accelerators

- Rolf Widerøe, 1924
- His PhD thesis was to realise a single drift tube with 2 gaps. 25kV, 1MHz AC voltage produced a 50keV kinetic energy beam.
- First resonant accelerator (patented)

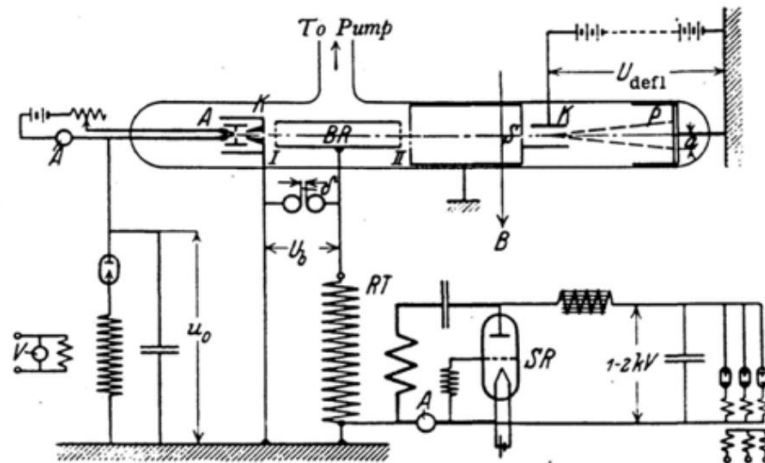

The linear accelerator & it's AC powering circuit

Historical note: He was influenced by Gustav Ising's work, which was never realised in practise as he didn't use an AC source.

Ising, Gustav. *Arkiv F ur Matematik, Astronomi Och Fysik* **18** (4), 1928

# Linear Accelerators

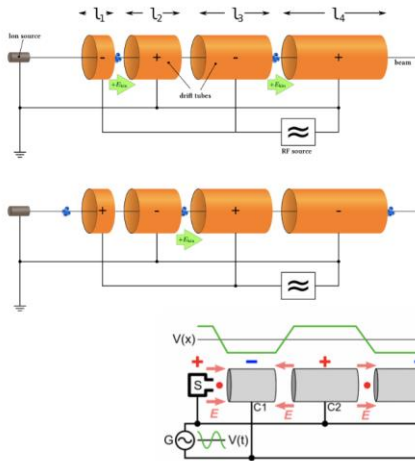

$$l = \beta \lambda_{rf} / 2 = v / 2 f_{rf}$$

- For high energy, need high frequency RF sources
- Weren't available until after WWII

But Wideroe's idea was not quite an RF cavity, Alvarez introduced that...

## Phase focusing in linacs

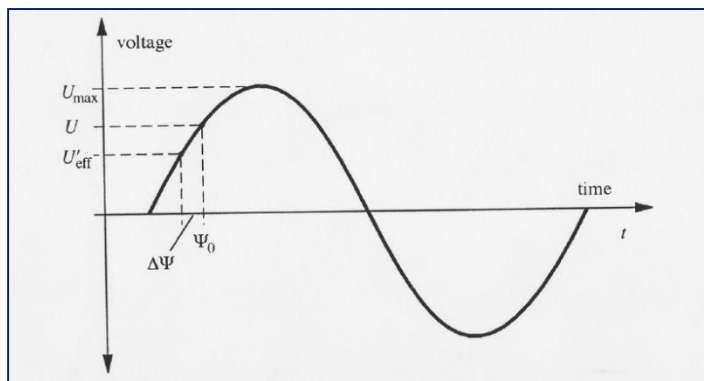

## ■ Principle

- Use rapidly-changing high frequency voltages instead of direct voltages (Ising)
- Energy is proportional to number of stages  $i$  traversed by particle.
- The largest voltage in entire system is never greater than  $V_{max}$ 
  - Arbitrary high energies without voltage discharge.

# Drift Tube Linac: Higher Integrated Field

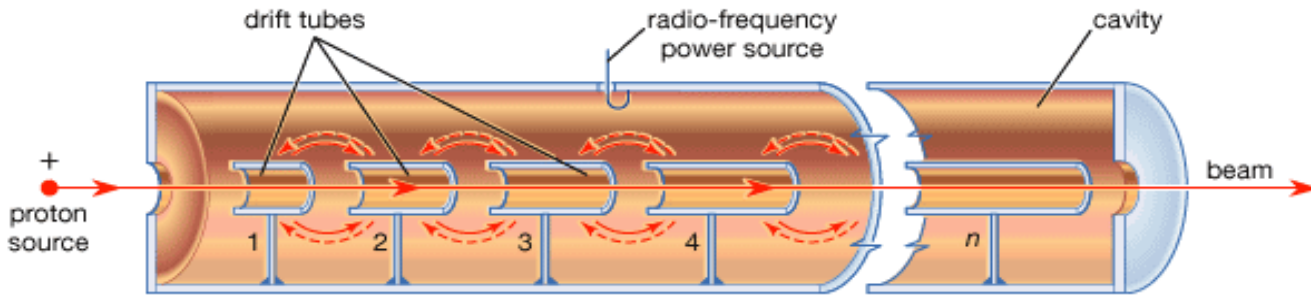

© 2007 Encyclopædia Britannica, Inc.

CERN LINAC1

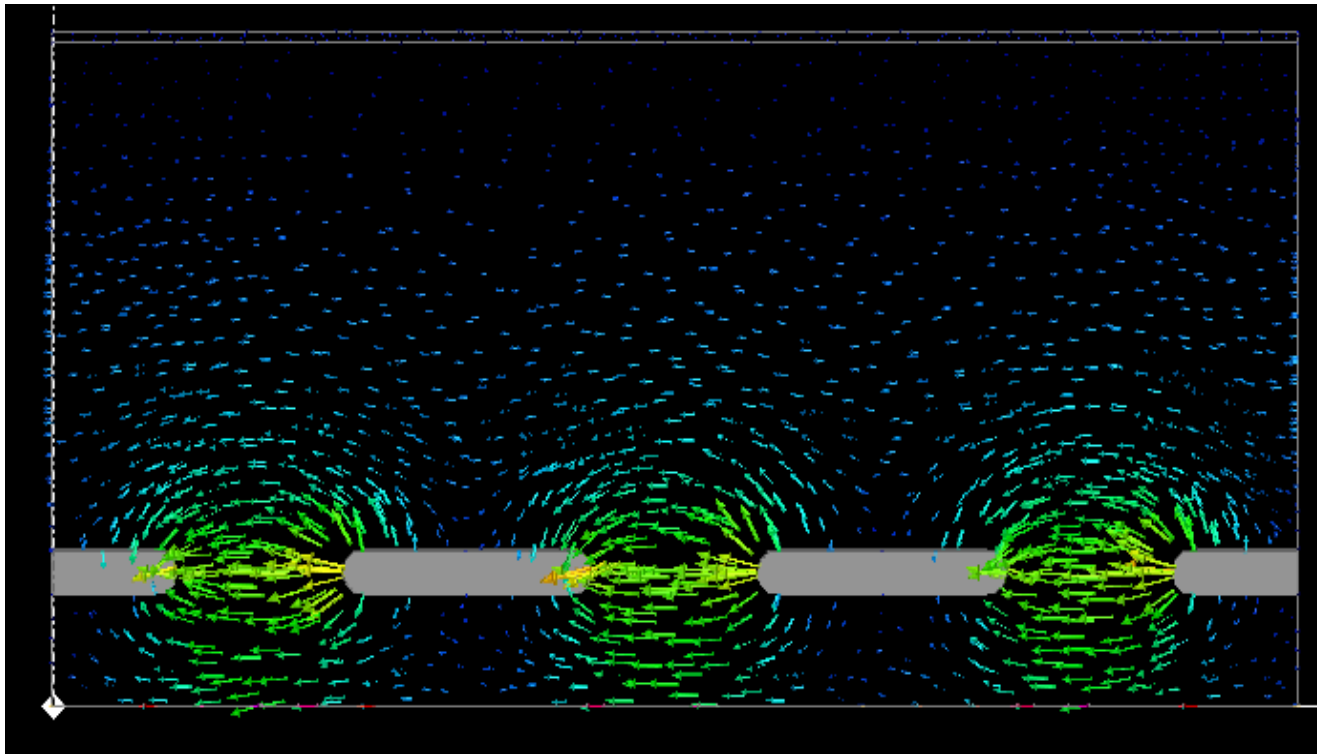
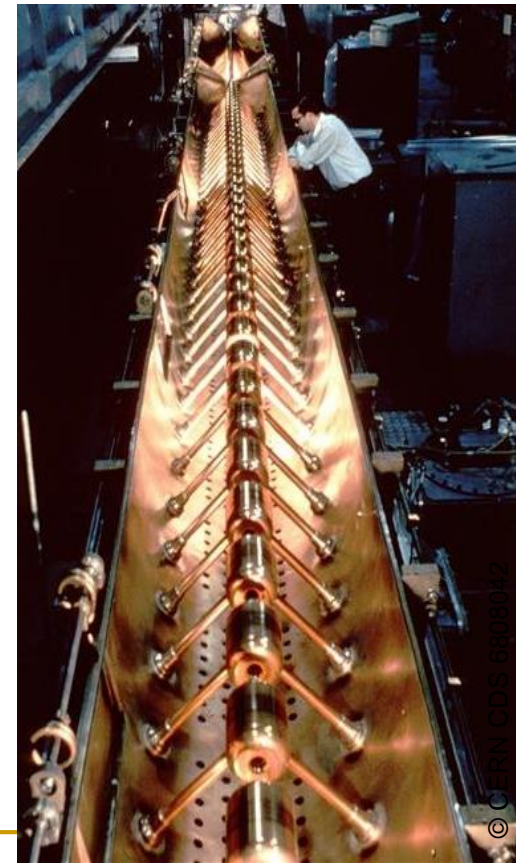

# Linac Structures

Images thanks to Ciprian Plostinar, RAL



DTL: Drift Tube Linac

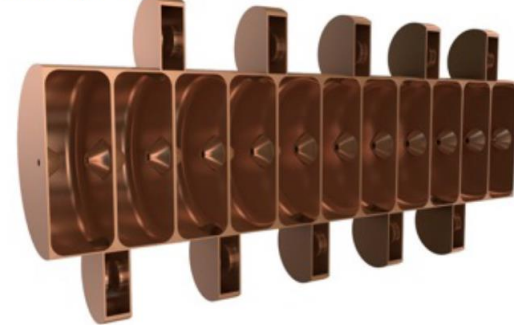

CCL: Coupled Cavity Linac

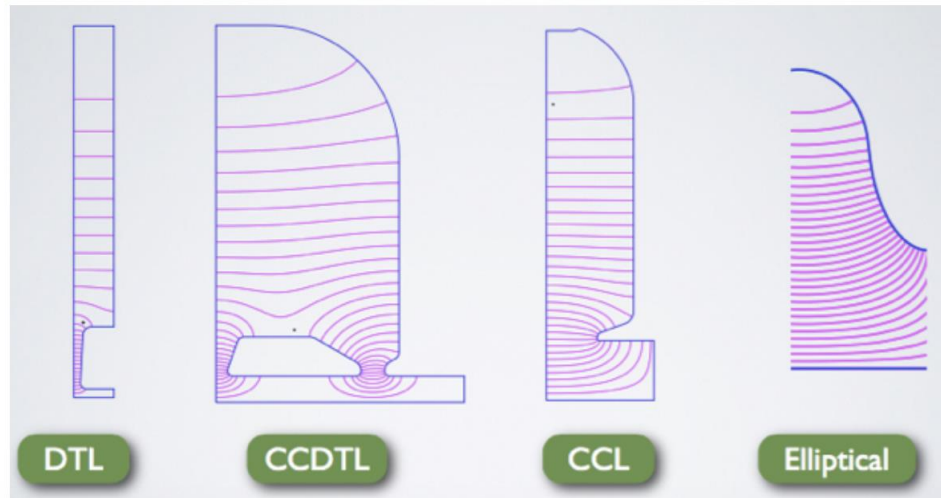

F. Gerigk, CERN

# The Cyclotron (1/3)

- In 1929-1930 Lawrence designed a “cyclotron”, a circular device made of two electrodes placed in a magnetic field.
- Cyclotrons can accelerate (e.g.) protons up to hundreds of MeV.

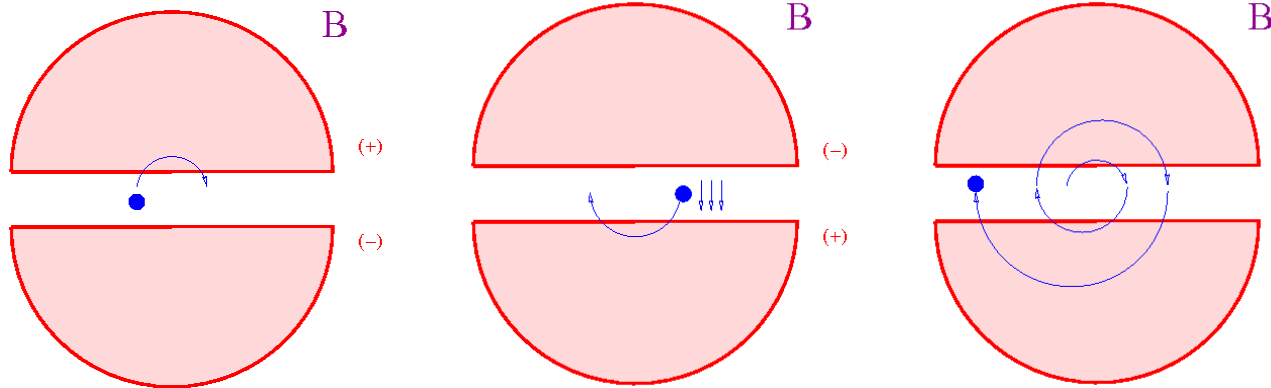
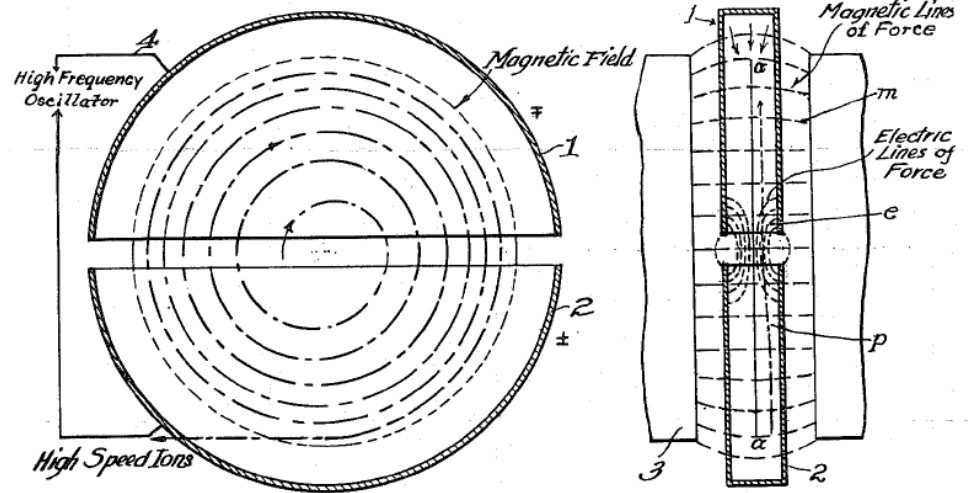

# The Cyclotron (2/3)

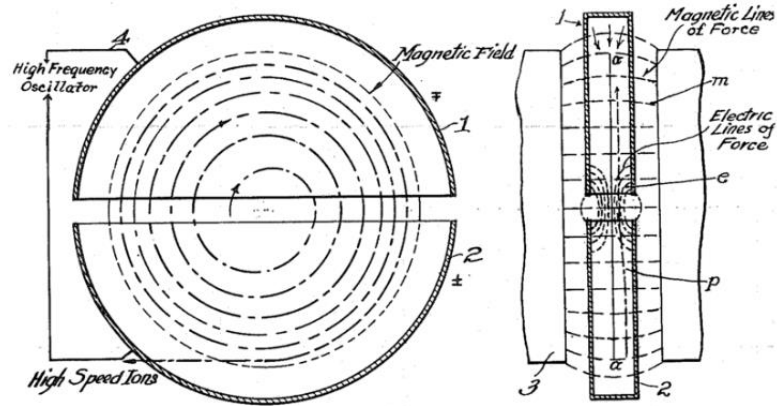

The Cyclotron, from E. Lawrence's 1934 patent

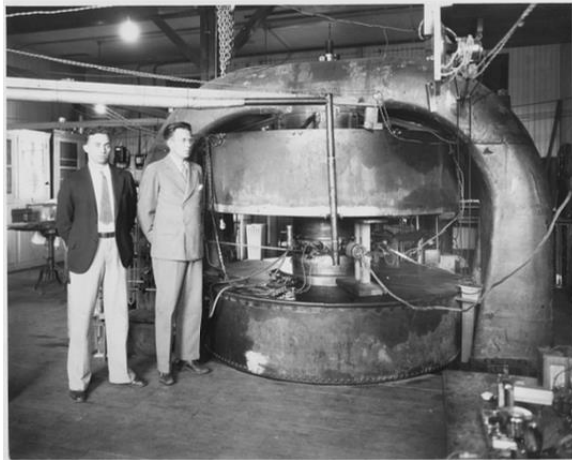

E. Lawrence & M. Stanley Livingston

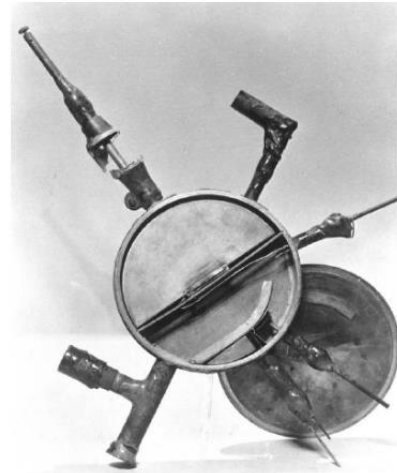

The first cyclotron

We will discuss cyclotron focusing in  
Transverse Dynamics I



# Cyclotron (3/3)

Centrifugal force = magnetic force

$$\frac{mv_{\theta}^2}{\rho} = qv_{\theta}B_z$$

Revolution frequency  $\omega_0 = v_{\theta} / \rho$

*Lawrence: "R cancels R!"*  
Cancelling out rho gives:

$$\omega_0 = qB_z / m$$

$$\rho = mv / qB_z$$



Ernest Lawrence

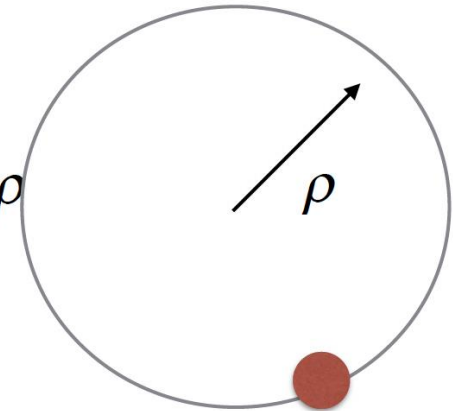

ie. for constant charge  $q$  and mass  $m$ , and a uniform magnetic field  $B$ , the angular frequency is constant. ie. the rf frequency can be constant. The orbit radius is proportional to speed,  $v$ .

# The Betatron

- Like a transformer with the beam as a secondary coil
- Usually used for relativistic electrons (so different from a cyclotron).
- Max energy achieved 300 MeV
- Accelerating field produced by a changing magnetic field that also serves to maintain electrons in a circular orbit of fixed radius as they are accelerated

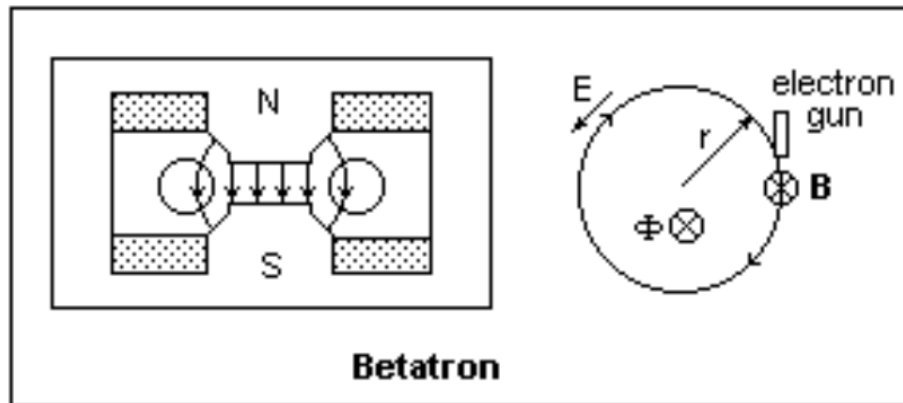

Image: <http://mysite.du.edu/~jcalvert/phys/partelec.htm#Tron>

Equate Faradays law on induction & Lorentz force law gives...

$$B_{orbit} = \frac{\Phi}{2\pi r^2} \rightarrow B_{orbit} = \frac{\bar{B}}{2}$$

since  $\bar{B} = \frac{\Phi}{\pi r^2}$  **Wideroe Condition**

<http://physics.princeton.edu/~mcdonald/examples/betatron.pdf>

**Centripetal force provided by Lorentz force**

# The Synchrotron - Origins

“Particles should be constrained to move in a circle of constant radius thus enabling the use of an annular ring of magnetic field...which would be varied in such a way that the radius of curvature remains constant as the particle gains energy through successive accelerations by an alternating electric field applied between coaxial hollow electrodes.”

Mark Oliphant, Oak Ridge, 1943

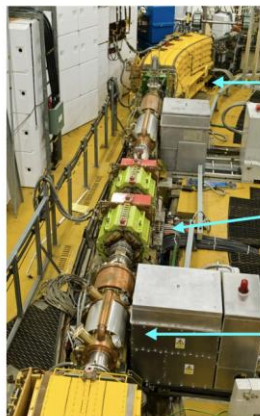

dipole magnets

quadrupole magnets

rf cavity

Image courtesy of ISIS, STFC



With Ernest Rutherford in 1932

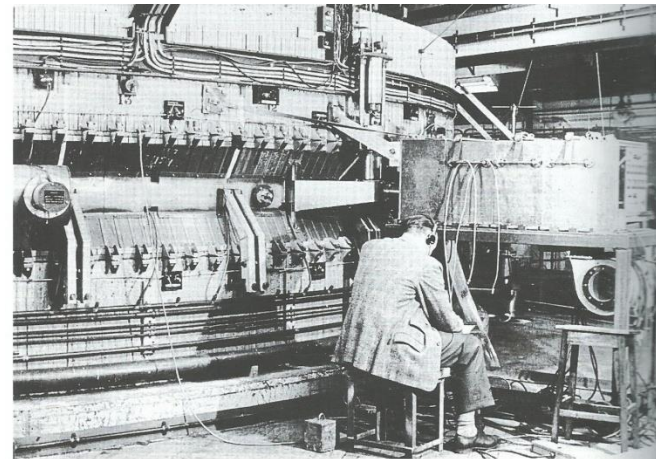

1 GeV machine at Birmingham University

# Synchrotrons - Principles

- From

$$R = E / (ecB)$$

$E/B$  kept constant since  $R$  is fixed.

$B$  increases synchronously with rising  $E$

- Synchrotrons, such as LHC, can accelerate to much higher energies.
- Limitation of synchrotrons (especially for electrons) is due to “synchrotron radiation”.

$R$  = radius of curvature

$E$  = particle energy

$B$  = magnetic field

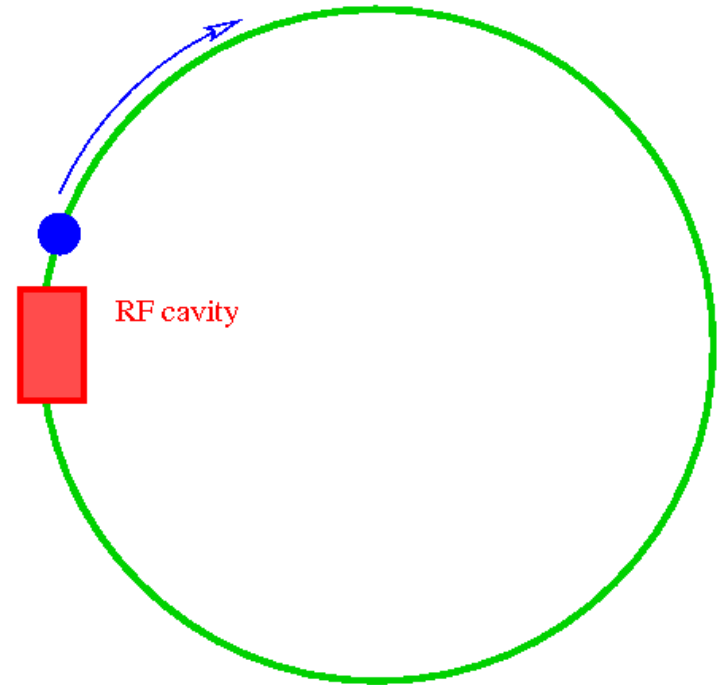

# Beam Optics

- Physical fundamentals for beam steering & focusing.
- Fix particle trajectory and then repeatedly steer diverging particles back onto ideal trajectory.
- Performed by EM fields ( $\mathbf{E}$  and  $\mathbf{B}$ ) satisfying Lorentz Force

$$\mathbf{F} = e(\mathbf{E} + \mathbf{v} \times \mathbf{B}) = \dot{\mathbf{p}}$$

- Lorentz force = centrifugal force

$$F_x = -ev_s B_z$$

$$F_r = mv_s^2 / R$$

$$\frac{1}{R(x, z, s)} = \frac{e}{p} B_z(x, z, s)$$

# Magnetic Rigidity

- ✓ The force  $e\mathbf{v}\mathbf{B}$  on a charged particle moving with velocity  $\mathbf{v}$  in a dipole field of strength  $\mathbf{B}$  is equal to its mass multiplied by its acceleration towards the centre of its circular path.

- ✓ This is:

$$F = evB = \frac{mv^2}{\rho}$$

Radius of curvature

*Like for a stone attached to a rotating rope*

- ✓ Which can be written as:

$$B\rho = \frac{mv}{e} = \frac{p}{e}$$

Momentum  
 $P=mv$

- ✓  $B\rho$  is called the magnetic rigidity, and in the correct units obtain:

$$B\rho = 33.356 \cdot p \text{ [KG}\cdot\text{m]} = 3.3356 \cdot p \text{ [T}\cdot\text{m]} \quad (\text{if } p \text{ is in [GeV/c])}$$

# Energy & Momentum

Total energy:  
kinetic + rest mass

- Einstein's relativity formula:

$$E = mc^2$$

- ⌘ For a mass at rest this will be:

$$E_0 = m_0 c^2$$

Rest mass

Rest energy

- ⌘ Define:

$$\gamma = \frac{E}{E_0}$$

as being the ratio between the total energy and the rest energy.

- ⌘ Then the mass of a moving particle is:

$$m = \gamma m_0$$

- ⌘ Define:

$$\beta = \frac{v}{c}$$

, then can write:

$$\beta = \frac{mvc}{mc^2}$$

- ⌘  $p = mv$ , which is always true and gives:

$$\beta = \frac{pc}{E}$$

or

$$p = \frac{E\beta}{c}$$

# Multipoles in Beam Steering

- Magnetic field around beam is sum of multipoles.
  - Each has different effect on particle path.
- Linear beam optics refers to use of only dipoles and quadrupoles for beam steering.

$$\begin{aligned}\frac{e}{p}B_z(x) &= \frac{e}{p}B_{z0} + \frac{e}{p}\frac{dB_z}{dx}x + \frac{1}{2!}\frac{e}{p}\frac{d^2B_z}{dx^2}x^2 + \frac{1}{3!}\frac{e}{p}\frac{d^3B_z}{dx^3}x^3 + \dots \\ &= \frac{1}{R} + kx + \frac{1}{2!}mx^2 + \frac{1}{3!}ox^3 + \dots\end{aligned}$$

dipole          quadrupole          sextupole          octupole

multipole	definition	effect
dipole	$\frac{1}{R} = \frac{e}{p}B_{z0}$	beam steering
quadrupole	$k = \frac{e}{p}\frac{dB_z}{dx}$	beam focusing
sextupole	$m = \frac{e}{p}\frac{d^2B_z}{dx^2}$	chromaticity compensation
octupole	$o = \frac{e}{p}\frac{d^3B_z}{dx^3}$	field errors or field compensation
etc.		



# Synchrotrons- Bending Magnets

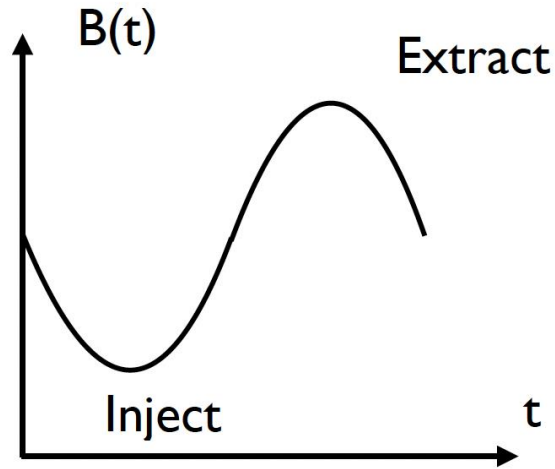

Typical synchrotron magnet cycle

Bending angle in dipole magnet

$$\sin(\theta / 2) = \frac{B(t)L}{2(B(t)\rho)} \quad \theta \approx \frac{B(t)L}{p(t)/q}$$

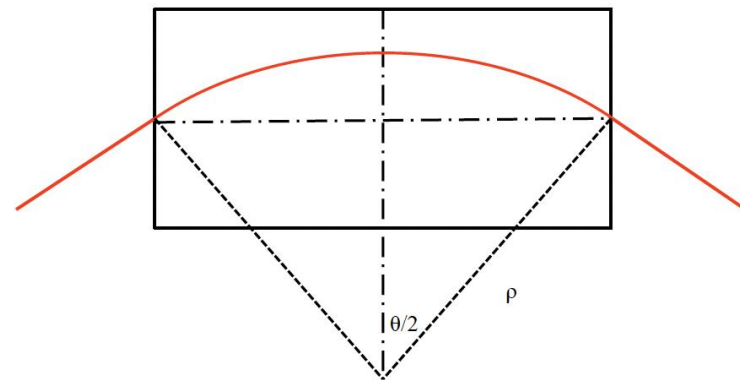

# Synchrotrons - Focusing

- Focusing is needed to confine the orbits.
- First accelerators had “weak focusing” – focusing period is larger than the perimeter.
  - Vertical focusing comes from the curvature of the field lines when the field falls off with radius.
  - Horizontal focusing from the curvature of the path.
  - Negative field gradient defocuses horizontally & must not be so strong as to cancel path curvature effect

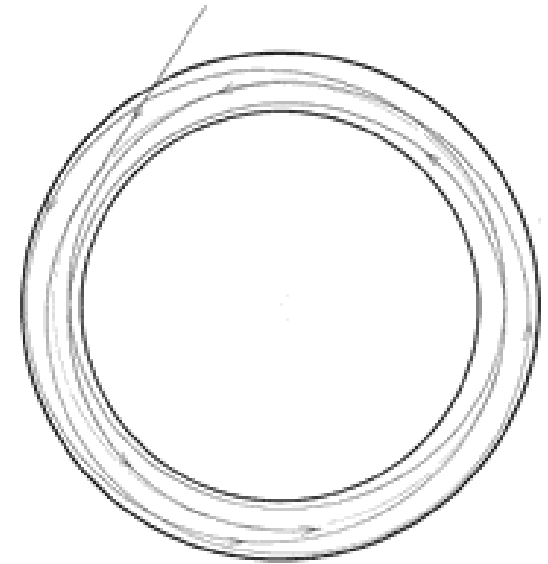

Weak focusing accelerator

10 GeV weak-focusing Synchrophasotron built in Dubna in 1957, the biggest and the most powerful of its time. Its magnets weigh 36,000 tons and it was registered in the Guinness Book of Records as the heaviest in the world.



# Synchrotron – Focusing Magnets

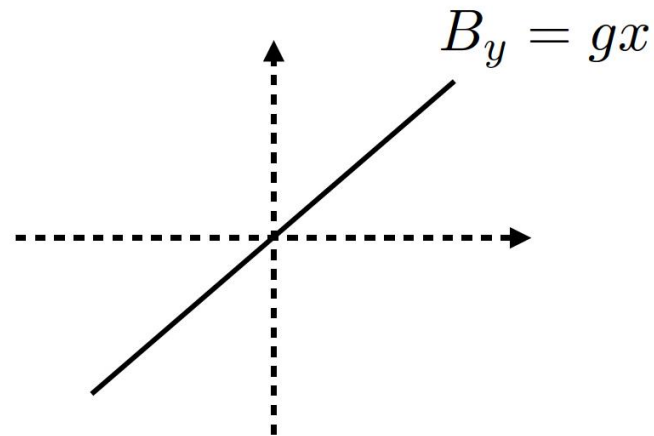
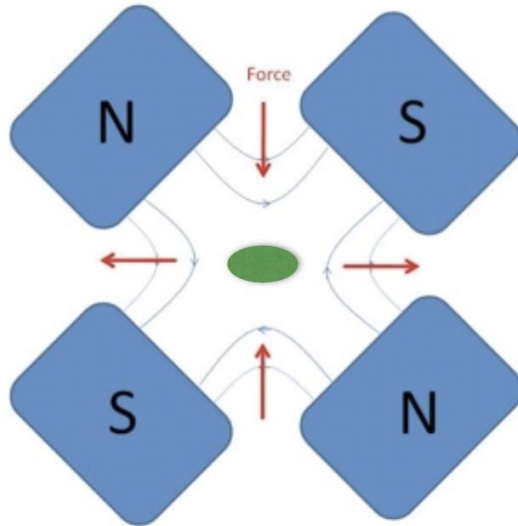

$$k = \frac{g}{p/q}$$

$$\frac{1}{f} = \frac{L(dB(t)/dx)}{p(t)/q}$$

'normalised gradient' of quad

- “Strong focusing” alternates focusing-defocusing forces (provided by quadrupoles) to give overall focusing in both X & Y planes.

Strong focusing allows use of more compact magnets, thus achieving many times larger energy with the same cost.



200-m diameter ring, weight of magnets 3,800 tons

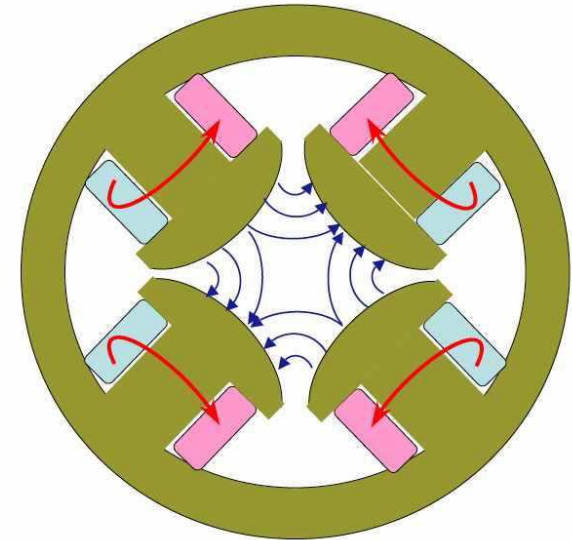
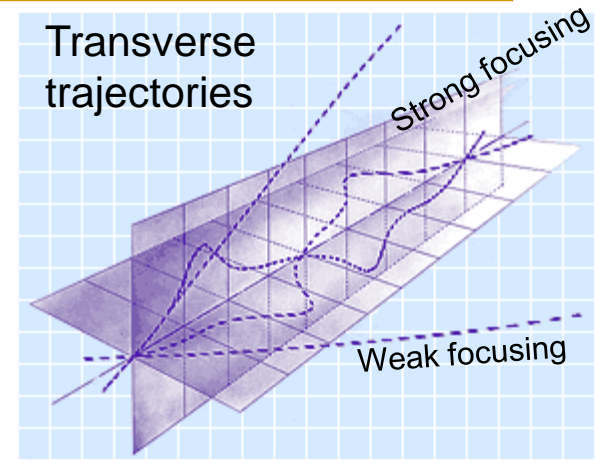

CERN's Proton Synchrotron, was the first operating strong-focusing accelerator.

# Synchrotron – Phase Stability

a - synchronous

b - arrives early, sees higher voltage, goes to larger orbit -> arrives later next time

c - arrives late, sees lower voltage, goes to smaller orbit -> arrives earlier next time

$$V = V_0 \sin(2\pi f_a t + \phi_s)$$

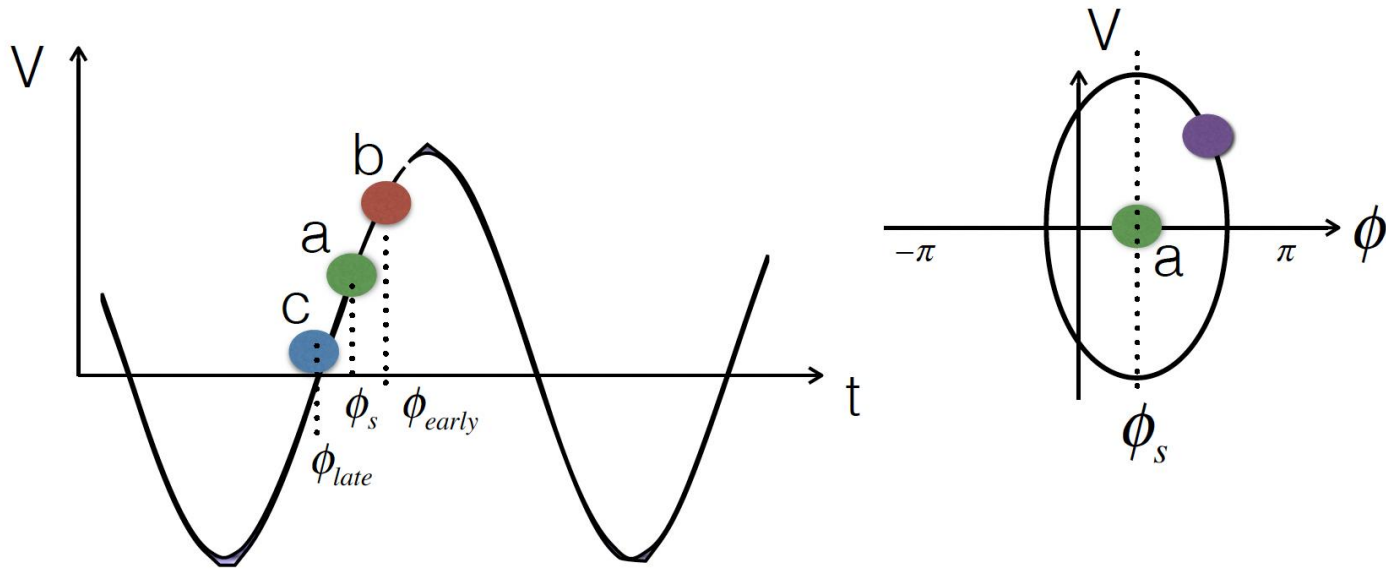

# Why Colliders?

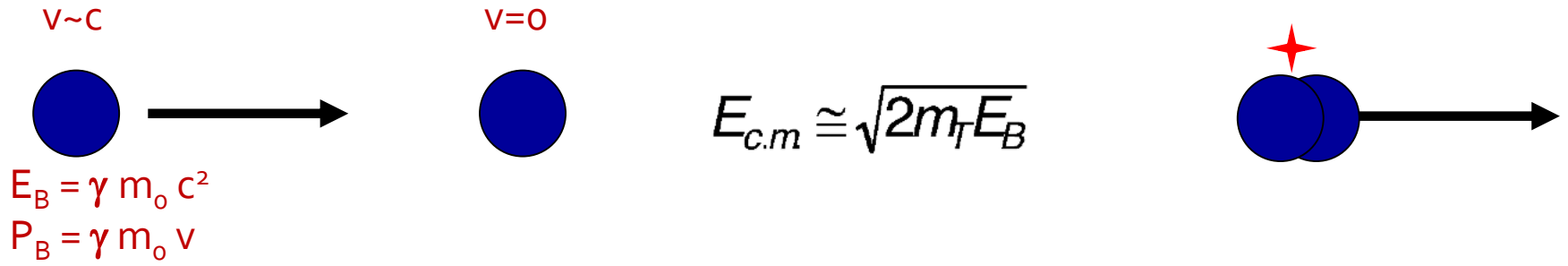

Only a tiny fraction of energy converted into mass of new particles  
(due to energy and momentum conservation)

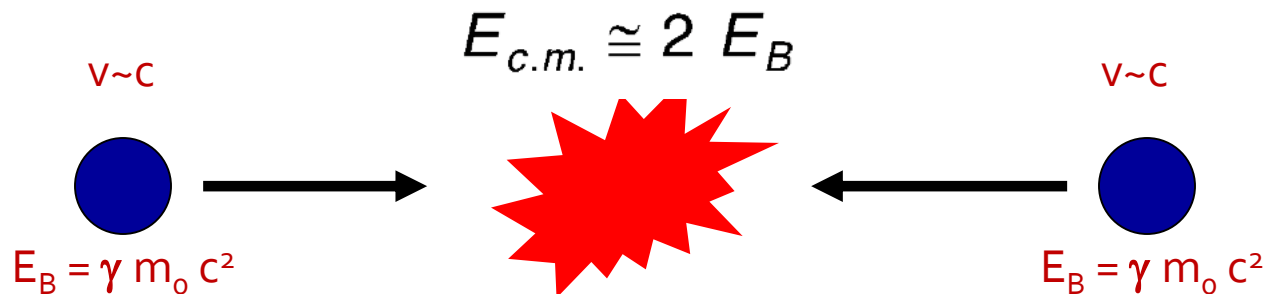

# De Broglie Wavelength

Momentum

$$\lambda = h / p \quad (1.2 \text{ fm} / p [\text{GeV}/c])$$

Planck Constant

De Broglie  
Wavelength

**De Broglie Wavelength**  
Wave-particle duality;  
For higher E, probe shorter  
distances inside matter

# Luminosity

Particle colliders designed to deliver two basic parameters to HEP user.

- Measure of collision rate per unit area.
- Event rate for given event probability (“cross-section”):

For a Collider, instantaneous luminosity  $L$  is given by

$$R = \mathcal{L} \sigma$$

- → Require intense beams, high bunch frequency and small beam sizes at IP.

$$\frac{N_+ N_- f_c}{4\pi \sigma_x^* \sigma_y^*}$$



# Cross-sections at the LHC

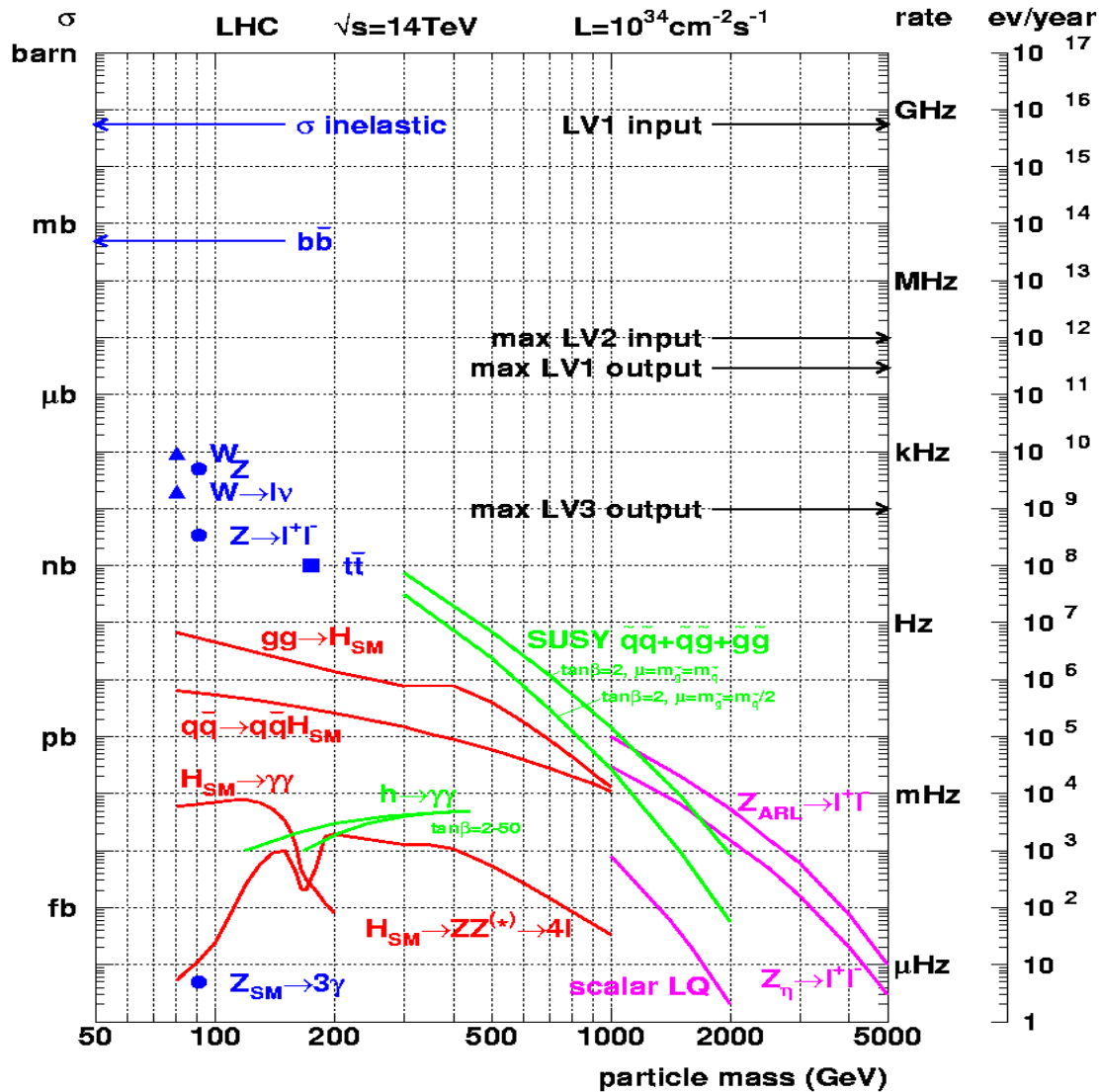

“Well known” processes. Don’t need to keep all of them ...

New Physics!!  
We want to keep!!

---

# Collider Types

## ■ Hadron Colliders

- Desire high energy
    - Only ~10% of beam energy available for hard collisions producing new particles
      - Need  $O(10 \text{ TeV})$  Collider to probe 1 TeV mass scale.
      - High-energy beam requires strong magnets to store and focus beam in reasonable-sized ring.
  - Desire high luminosity
    - Use proton-proton collisions.
      - High bunch population and high bunch frequency.
    - Anti-protons difficult to produce if beam is lost
      - *c.f.* SPS Collider and Tevatron
-

# Collider Types

## ■ Lepton Colliders (e+e-)

- Synchrotron radiation is the most serious challenge
  - Energy loss of a particle per turn

$$U_0 = \frac{4\pi}{3} \frac{r_e \gamma^4}{R} mc^2$$

- Emitted power in circular machine is

$$P_{SR}[\text{kW}] = \frac{88.5 E^4[\text{GeV}] I[\text{A}]}{\rho[\text{m}]}$$

- For collider with  $E_{CM} = 1 \text{ TeV}$  in the LHC tunnel with a 1 mA beam, radiated power would be 2 GW
  - Would need to replenish radiated power with RF
  - Remove it from vacuum chamber
- Approach for high energies is Linear Collider.

# Collider Characteristics

## ■ Hadron collider at the frontier of physics

- Huge QCD background
- Not all nucleon energy available in collision

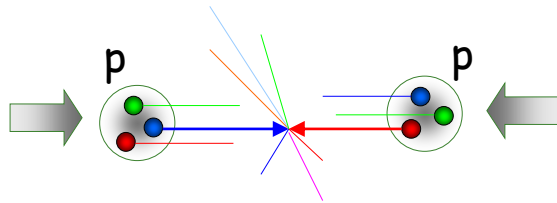

## ■ Lepton collider for precision physics

- Well defined initial energy for reaction
- Colliding point like particles

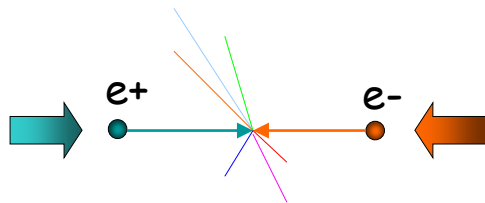

ATLAS  $Z \rightarrow \mu\mu$  event from 2012 data with 25 reconstructed vertices

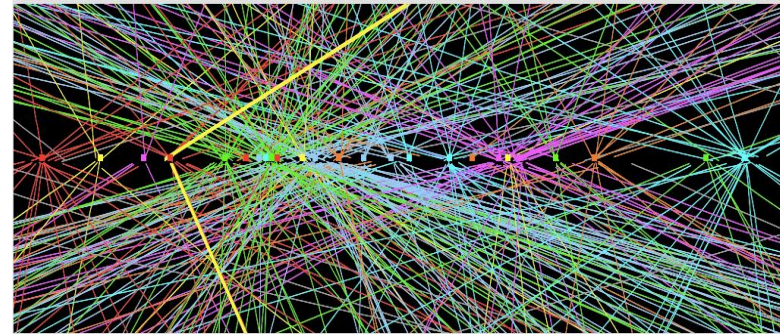

Simulation of HIGGS production  $e^+e^- \rightarrow Z H$   
 $Z \rightarrow e^+e^-$ ,  $H \rightarrow bb$

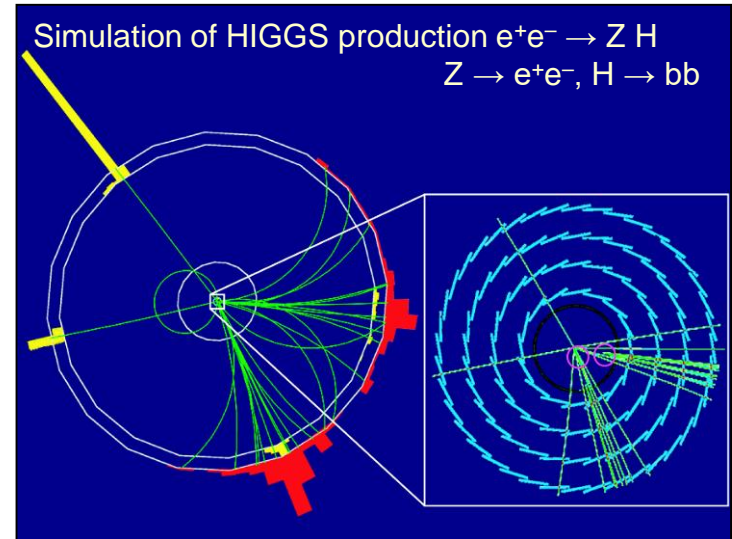

The Higgs is hiding in thousands of trillions interactions...



# Circular versus Linear Collider

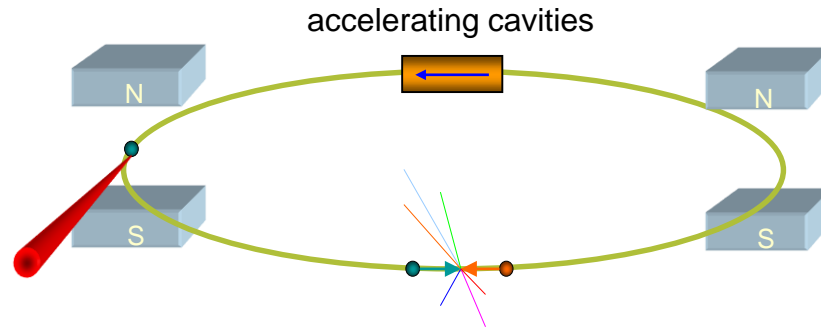

## Circular Collider

many magnets, few cavities, stored beam  
higher energy  $\rightarrow$  stronger magnetic field  
 $\rightarrow$  higher synchrotron radiation losses ( $E^4/m^4R$ )

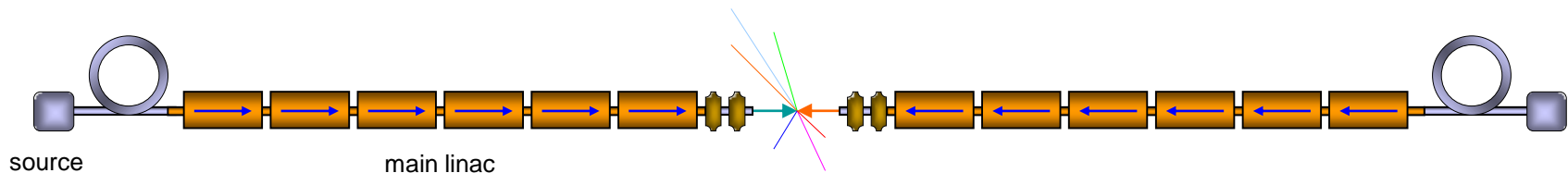

## Linear Collider

few magnets, many cavities, single pass beam  
higher energy  $\rightarrow$  higher accelerating gradient  
higher luminosity  $\rightarrow$  higher beam power (high bunch repetition)

# A New Era in Fundamental Science

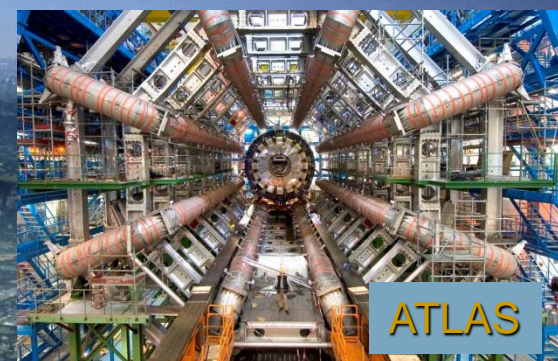

Exploration of a new energy frontier  
in p-p and Pb-Pb collisions



# Scientific priorities for the future

Implementation of the recommendations of the **2020 Update of the European Strategy for Particle Physics**:

- Fully exploit the LHC and the HL-LHC.
- Build a Higgs factory to further understand this unique particle.
- Investigate the technical and financial feasibility of a future energy-frontier 100 km collider at CERN.
- Ramp up relevant R&D.
- Continue supporting other projects around the world.





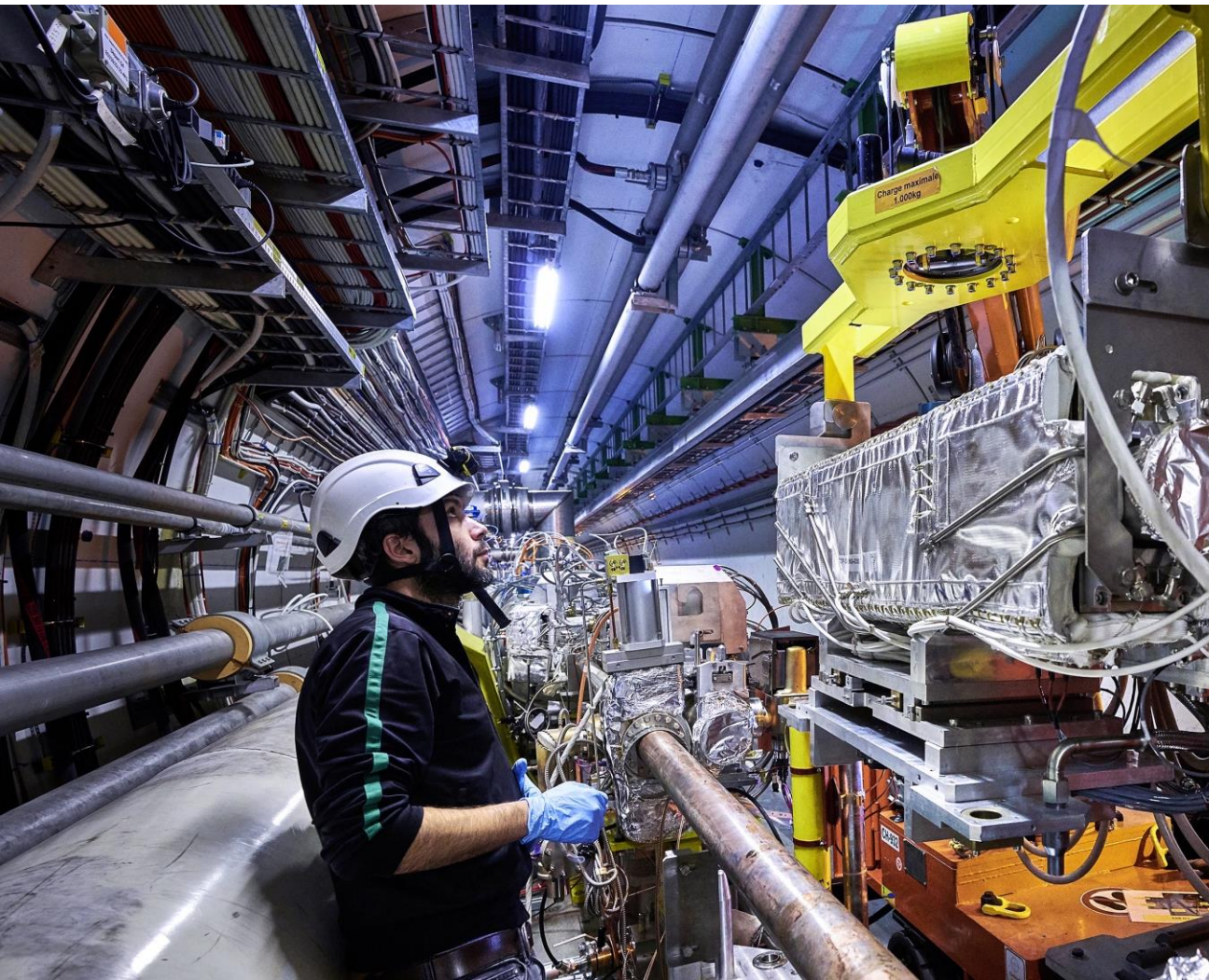

## Upgrade to the High-Luminosity LHC is under way

- The HL-LHC will use new technologies to provide 10 times more collisions than the LHC.
- It will give access to rare phenomena, greater precision and discovery potential.
- It will start operating in 2029, and run until approx. 2040.

# High-Luminosity LHC (HL-LHC)

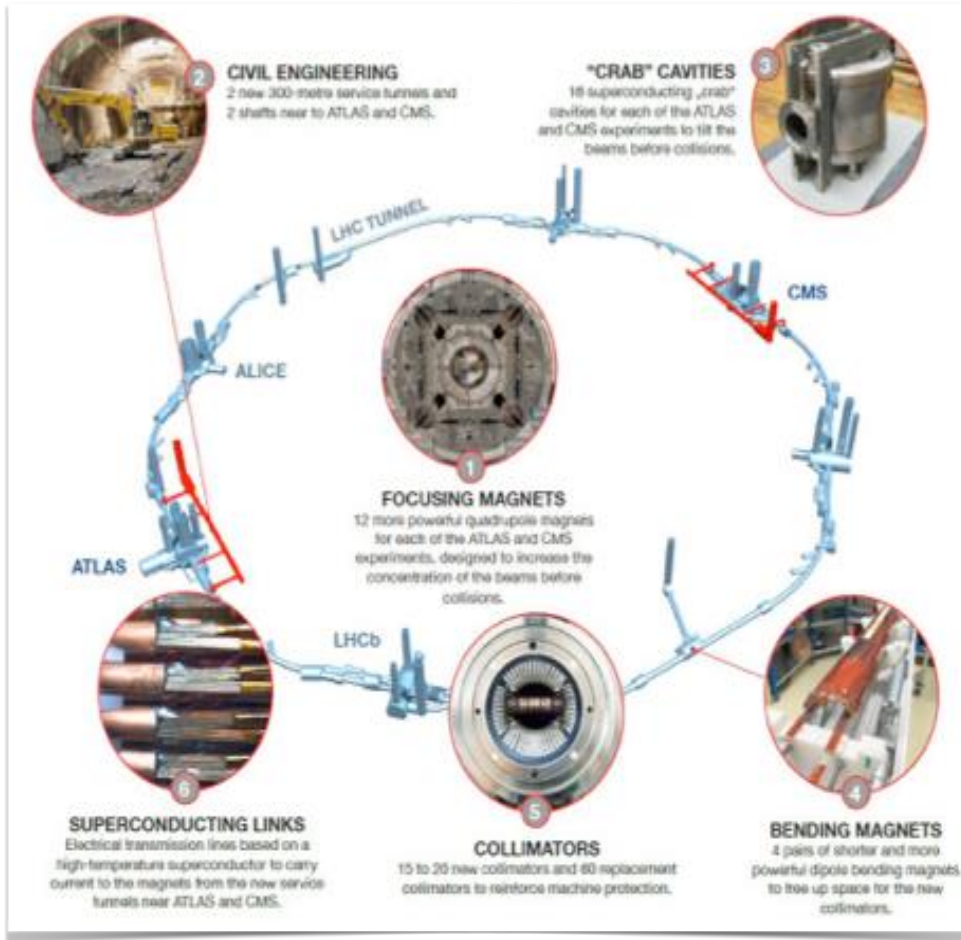

- New quadrupole magnets near the interaction points
- New 11 Tesla short dipole magnets
- Collimation upgrade
- Crab Cavities
- Accelerator safety upgrade
- Major interventions on 1.2 km of the LHC

# Future Circular Collider Study (FCC)

Forming an international collaboration to study:

- $pp$ -collider (*FCC-hh*) →  
defining infrastructure requirements

~16 T  $\Rightarrow$  100 TeV  $pp$  in 100 km

~20 T  $\Rightarrow$  100 TeV  $pp$  in 80 km

- $e^+e^-$  collider (*FCC-ee*) as potential intermediate step

- $p-e$  (*FCC-he*) option

- 80-100 km infrastructure in Geneva area

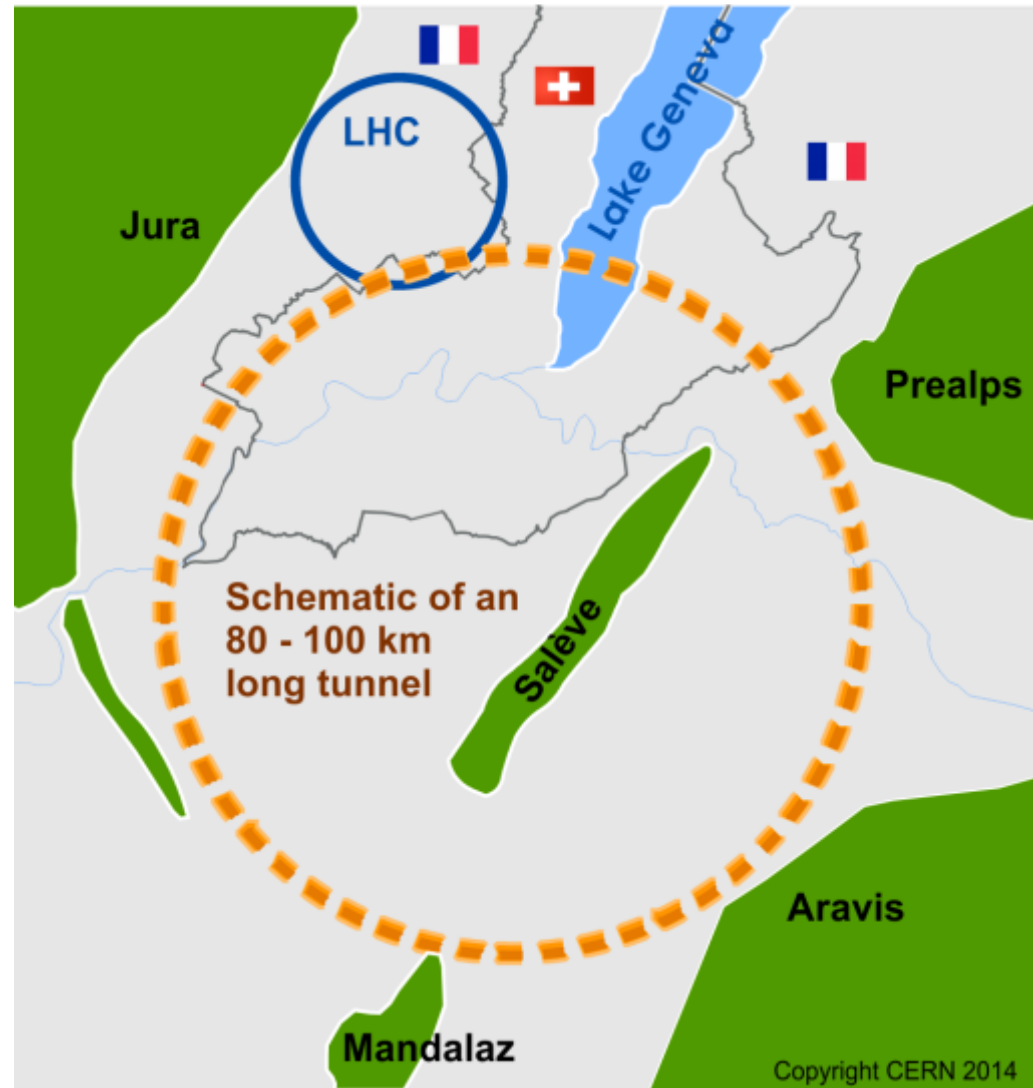

# The FCC Integrated Programme

## Inspired by Successful LEP – LHC Programmes at CERN

### Comprehensive long-term programme maximising physics opportunities

- Stage 1: FCC-ee (Z, W, H,  $t\bar{t}$ ) as Higgs factory, electroweak & top factory at highest luminosities
- Stage 2: FCC-hh (~100 TeV) as natural continuation at energy frontier, with ion and eh options
- Complementary physics
- Common civil engineering and technical infrastructures, building on and reusing CERN's existing infrastructure
- FCC integrated project allows seamless continuation of HEP after completion of the HL-LHC programme

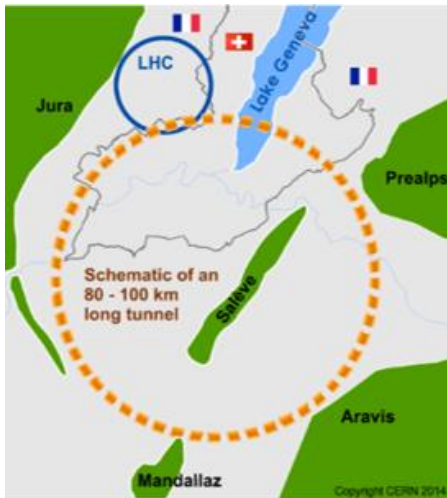

2020 - 2040

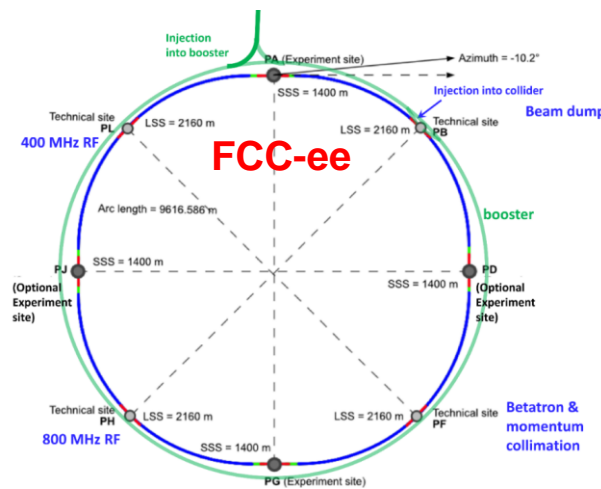

2045 - 2060

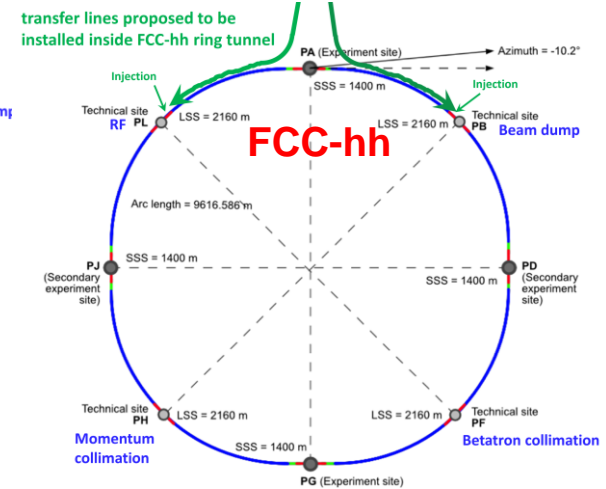

2070 - 2090++

# Stage 1: Updated Parameters

K. Oide, D. Shatilov,

Parameter [4 IPs, 91.2 km, $T_{rev}=0.3$ ms]	Z	WW	H (ZH)	ttbar
beam energy [GeV]	45	80	120	182.5
beam current [mA]	1280	135	26.7	5.0
number bunches/beam	10000	880	248	36
bunch intensity [ $10^{11}$ ]	2.43	2.91	2.04	2.64
SR energy loss / turn [GeV]	0.0391	0.37	1.869	10.0
total RF voltage 400/800 MHz [GV]	0.120/0	1.0/0	2.08/0	4.0/7.25
long. damping time [turns]	1170	216	64.5	18.5
horizontal beta* [m]	0.1	0.2	0.3	1
vertical beta* [mm]	0.8	1	1	1.6
horizontal geometric emittance [nm]	0.71	2.17	0.64	1.49
vertical geom. emittance [pm]	1.42	4.34	1.29	2.98
horizontal rms IP spot size [ $\mu\text{m}$ ]	8	21	14	39
vertical rms IP spot size [nm]	34	66	36	69
beam-beam parameter $\xi_x / \xi_y$	0.004/ .159	0.011/0.111	0.0187/0.129	0.096/0.138
rms bunch length with SR / BS [mm]	4.38 / 14.5	3.55 / 8.01	3.34 / 6.0	2.02 / 2.95
luminosity per IP [ $10^{34}$ cm <sup>-2</sup> s <sup>-1</sup> ]	182	19.4	7.3	1.33
total integrated luminosity / year [ab <sup>-1</sup> /yr]	87	9.3	3.5	0.65
beam lifetime rad Bhabha + BS [min]	19	18	6	9

parameter	FCC-hh		HL-LHC	LHC
collision energy cms [TeV]	<b>100</b>		14	14
dipole field [T]	<b>~17 (~16 comb.function)</b>		8.33	8.33
circumference [km]	<b>91.2</b>		26.7	26.7
beam current [A]	<b>0.5</b>		1.1	0.58
bunch intensity [ $10^{11}$ ]	<b>1</b>	<b>1</b>	2.2	1.15
bunch spacing [ns]	25	25	25	25
synchr. rad. power / ring [kW]	<b>2700</b>		7.3	3.6
SR power / length [W/m/ap.]	<b>32.1</b>		0.33	0.17
long. emit. damping time [h]	<b>0.45</b>		12.9	12.9
beta* [m]	1.1	0.3	0.15 (min.)	0.55
normalized emittance [ $\mu\text{m}$ ]	<b>2.2</b>		2.5	3.75
peak luminosity [ $10^{34} \text{ cm}^{-2}\text{s}^{-1}$ ]	<b>5</b>	<b>30</b>	5 (lev.)	1
events/bunch crossing	<b>170</b>	<b>1000</b>	132	27
stored energy/beam [GJ]	<b>7.8</b>		0.7	0.36

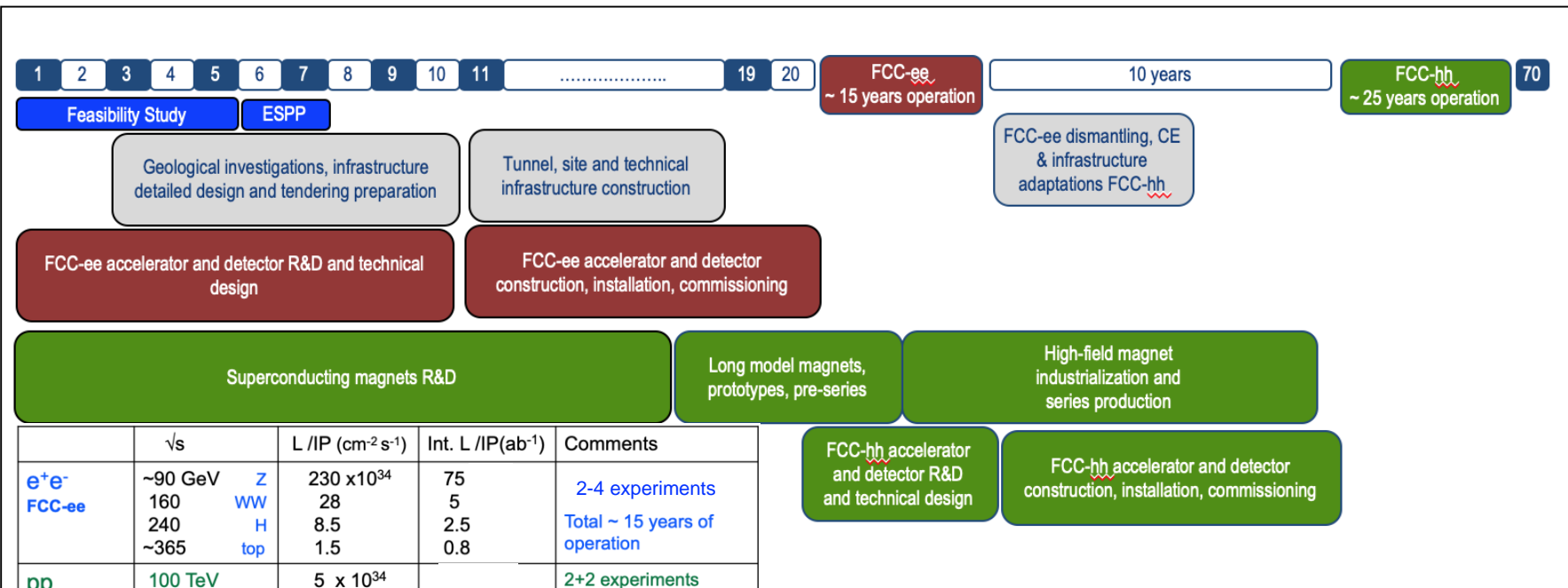

	$\sqrt{s}$	L /IP (cm <sup>-2</sup> s <sup>-1</sup> )	Int. L /IP(ab <sup>-1</sup> )	Comments
<b>e<sup>+</sup>e<sup>-</sup></b> <b>FCC-ee</b>	~90 GeV <i>Z</i> 160 <i>WW</i> 240 <i>H</i> ~365 <i>top</i>	230 x 10 <sup>34</sup> 28 8.5 1.5	75 5 2.5 0.8	2-4 experiments Total ~ 15 years of operation
<b>pp</b> <b>FCC-hh</b>	100 TeV	5 x 10 <sup>34</sup> 30	20-30	2+2 experiments Total ~ 25 years of operation
<b>PbPb</b> <b>FCC-hh</b>	$\sqrt{s_{NN}} = 39\text{TeV}$	3 x 10 <sup>29</sup>	100 nb <sup>-1</sup> /run	1 run = 1 month operation
<b>ep</b> <b>Fcc-eh</b>	3.5 TeV	1.5 10 <sup>34</sup>	2 ab <sup>-1</sup>	60 GeV e- from ERL Concurrent operation with pp for ~ 20 years
<b>e-Pb</b> <b>Fcc-eh</b>	$\sqrt{s_{eN}} = 2.2\text{ TeV}$	0.5 10 <sup>34</sup>	1 fb <sup>-1</sup>	60 GeV e- from ERL Concurrent operation with PbPb

- Feasibility Study: 2021-2025
- If project approved before end of decade → construction can start beginning 2030s
- FCC-ee operation ~2045-2060
- FCC-hh operation 2070-2090++

F. Gianotti

# Linear Colliders

## CLIC

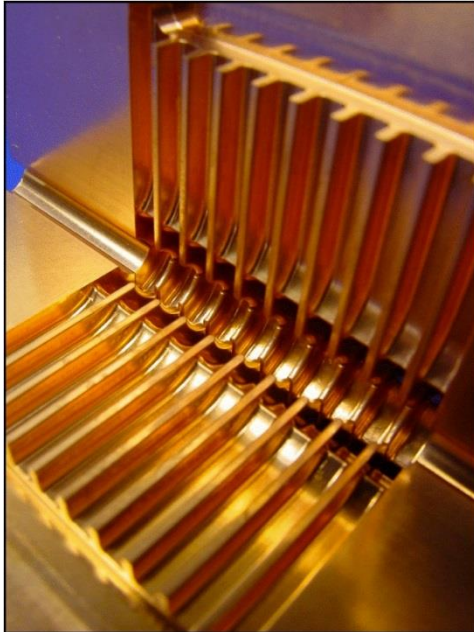

- 2-beam acceleration scheme at room temperature
- Gradient 100 MV/m
- $\sqrt{s}$  up to 3 TeV
- Physics + Detector studies for 350 GeV - 3 TeV

## Linear $e^+e^-$ colliders

Luminosities: few  $10^{34} \text{ cm}^{-2}\text{s}^{-1}$

## ILC



- Superconducting RF cavities (like XFEL)
- Gradient 32 MV/m
- $\sqrt{s} \leq 500 \text{ GeV}$  (1 TeV upgrade option)
- Focus on  $\leq 500 \text{ GeV}$ , physics studies also for 1 TeV



# The International Linear Collider (ILC)

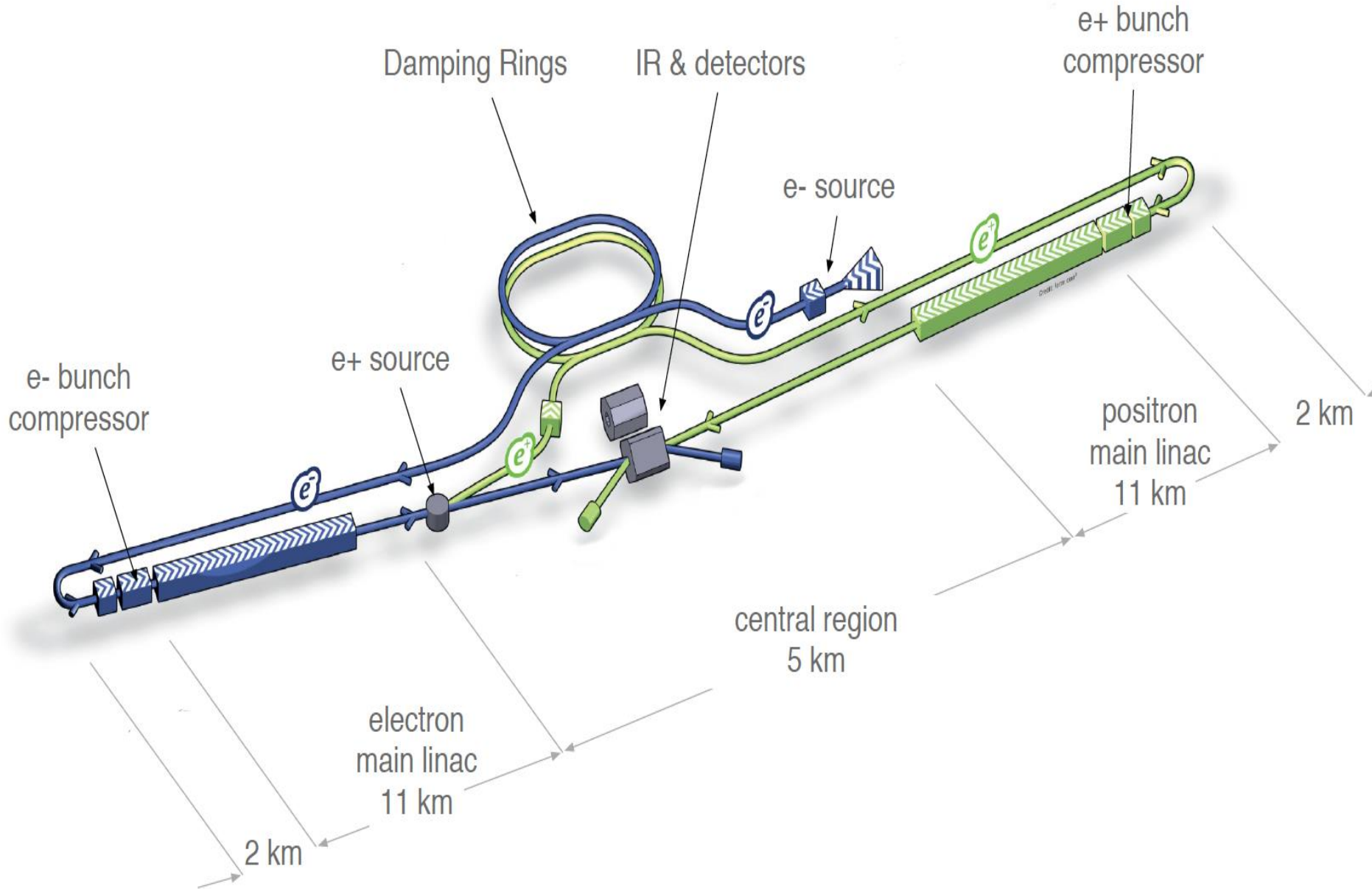

# CLIC Implementation

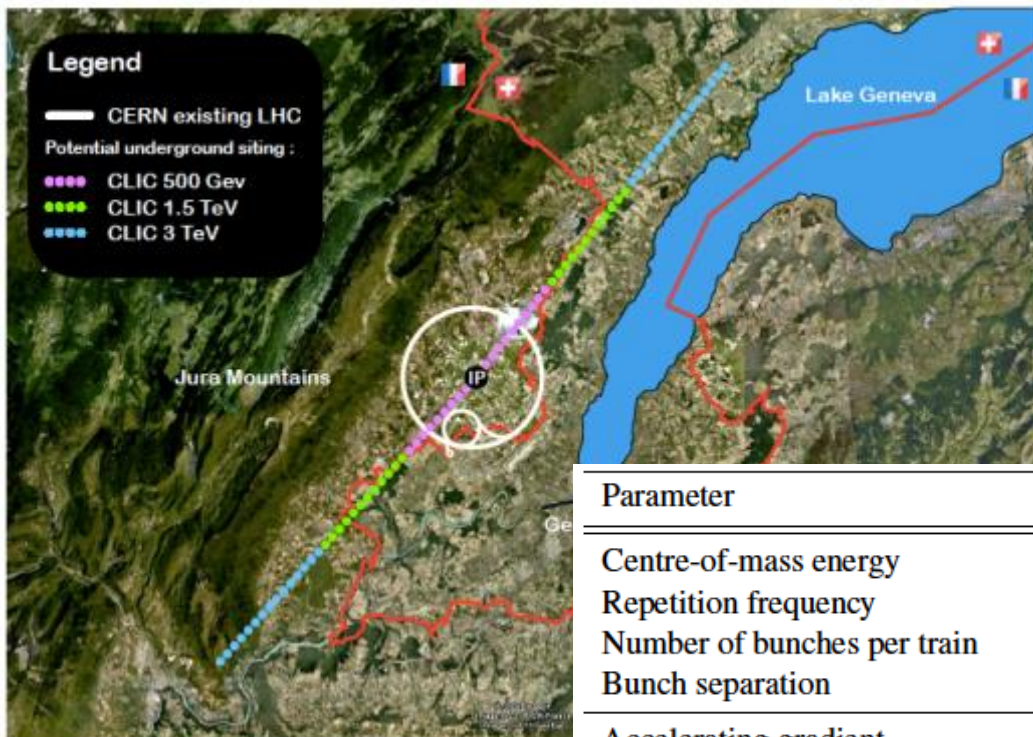

← Possible lay-out near CERN

↓ CLIC parameters

Parameter	Symbol	Unit			
Centre-of-mass energy	$\sqrt{s}$	GeV	500	1500	3000
Repetition frequency	$f_{rep}$	Hz	50	50	50
Number of bunches per train	$n_b$		312	312	312
Bunch separation	$\Delta_t$	ns	0.5	0.5	0.5
Accelerating gradient	$G$	MV/m	100	100	100
Total luminosity	$\mathcal{L}$	$10^{34} \text{ cm}^{-2} \text{ s}^{-1}$	1.3	3.7	5.9
Luminosity above 99% of $\sqrt{s}$	$\mathcal{L}_{0.01}$	$10^{34} \text{ cm}^{-2} \text{ s}^{-1}$	0.7	1.4	2
Main tunnel length		km	11.4	27.2	48.3
Charge per bunch	$N$	$10^9$	3.7	3.7	3.7
Bunch length	$\sigma_z$	$\mu\text{m}$	44	44	44
IP beam size	$\sigma_x/\sigma_y$	nm	100/2.6	$\approx 60/1.5$	$\approx 40/1$
Normalised emittance (end of linac)	$\epsilon_x/\epsilon_y$	nm	—	660/20	660/20
Normalised emittance	$\epsilon_x/\epsilon_y$	nm	660/25	—	—
Estimated power consumption	$P_{wall}$	MW	235	364	589

Note: the design is currently being re-optimised, e.g. to include 350 GeV as the first stage

# Physics with Muon Beams

## □ Muon Beams and the Neutrino Sector

$$\mu^+ \rightarrow e^+ \nu_e \bar{\nu}_\mu \Rightarrow 50\% \nu_e + 50\% \bar{\nu}_\mu$$

$$\mu^- \rightarrow e^- \bar{\nu}_e \nu_\mu \Rightarrow 50\% \bar{\nu}_e + 50\% \nu_\mu$$

Produces high energy neutrinos

- Decay kinematics well known
- $\nu_e \rightarrow \nu_\mu$  oscillations give easily detectable wrong-sign  $\mu$

## □ Muon Beams and the Energy Frontier

- Point particle makes full beam energy available for particle production.
  - Couples strongly to Higgs sector
- Muon Collider has almost no synchrotron radiation
  - Narrow energy spread
  - Fits on existing laboratory sites

# Muon Beam Challenges

- Muons created as tertiary beam ( $p \rightarrow \pi \rightarrow \mu$ )
  - Low production rate
    - Need target that can tolerate multi-MW beam
  - Large energy spread and transverse phase space
    - Need solenoidal focusing for the low-energy portions of the facility
      - Solenoids focus in both planes simultaneously,
    - Need ionisation cooling, high-acceptance acceleration system & decay ring.
- Muons have short lifetime (2.2  $\mu$ s at rest)
  - Mean distance travelled in the lab frame from production to decay
    - $L = (p/mc) c \tau$  with momentum  $p$ , mass  $m$ , lifetime at rest  $\tau$
  - Puts premium on rapid beam manipulations
    - High-gradient RF cavities (in magnetic field)
- Decay electrons give backgrounds in Collider detectors and instrumentation & heat load to magnets

# Muon Accelerator Synergies

## Neutrino Factory (NuMAX)

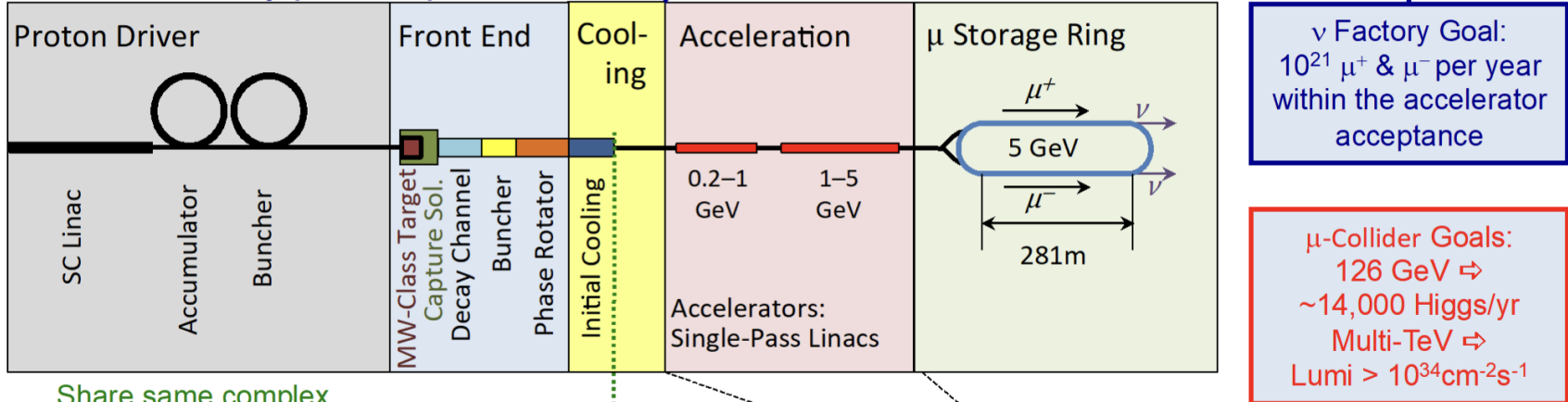

## Muon Collider

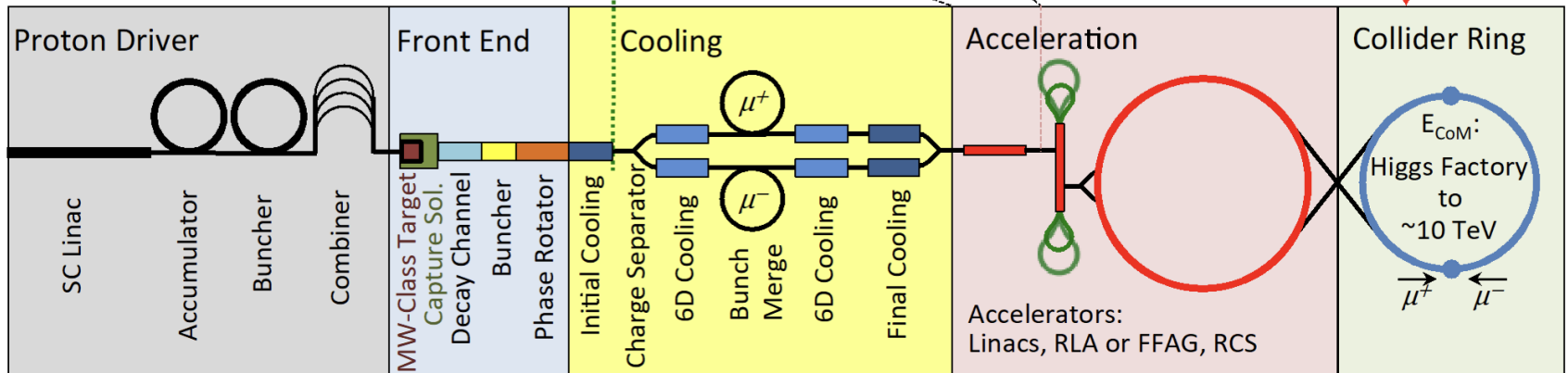

# Plasma Accelerators

RF Cavity



1 m => 100 MeV Gain

Electric field < 100 MV/m

Plasma Cavity

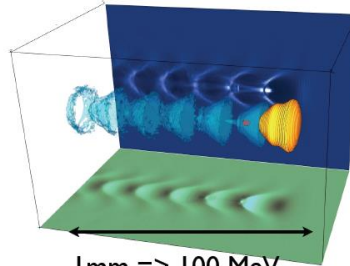

1 mm => 100 MeV

Electric field > 100 GV/m

V. Malka et al., Science **298**, 1596 (2002)

## Plasma accelerators:

Transform transverse fields into longitudinal fields.

Significantly higher accelerating gradients than conventional RF.

e.g. AWAKE at CERN

Demonstration experiment to verify novel technique of p-driven plasma wakefield acceleration

Laser driven

e- driven

p driven

Dielectric wakefields

---

# Bibliography

- *Unifying Physics of Accelerators, Lasers and Plasma*, Andrei Seryi, CRC Press, 2015
  - *The Physics of Particle Accelerators – An Introduction*, Klaus Wille, OUP, 2000
  - *An Introduction to Particle Accelerators*, Edmund Wilson, OUP, 2001
  - *Engines of Discovery*, Andrew Sessler & Edmund Wilson, World Scientific, 2006
  - *Engines of Discovery Revised & Expanded Edition*, Andrew Sessler & Edmund Wilson, World Scientific, 2014
-