



Instituto de
Física
Teórica
UAM-CSIC



Extended Higgs Sectors & Baryogenesis

Based on S. J. Huber, K. Mimasu, JMN, PRD 107 (2023) 075042 ([2208.10512](#))
+ J. M. Cano, S. Gori, K. Mimasu, JMN ([23xx.xxxxx](#))

Jose Miguel No
IFT-UAM/CSIC, Madrid



Origin of Matter-Antimatter Asymmetry

(Baryogenesis)

Sakharov Conditions

*(for dynamical generation
of baryon asymmetry)*

- B Violation
- C/CP Violation
- Departure from Thermal Equilibrium



Origin of Matter-Antimatter Asymmetry

Sakharov Conditions (for dynamical generation of baryon asymmetry)

In the
SM?

- B Violation ✓ (Sphalerons) (non-perturbative, high-temperature)
- C/CP Violation ✗ not enough
Gavela, Hernandez, Orloff, Pene, Quimbay, Nucl. Phys. B **430** (1994) 382
- Departure from Thermal Equilibrium ✗ not enough
Kajantie, Laine, Rummukainen, Shaposhnikov, Phys. Rev. Lett. **77** (1996) 2887

Origin of Matter-Antimatter Asymmetry

Sakharov Conditions (for dynamical generation of baryon asymmetry)

In the
SM?

- B Violation ✓ (Sphalerons) (non-perturbative, high-temperature)
- C/CP Violation ✗ not enough*

***SM CP Violation insufficient by ~ 10 orders of magnitude**

via 3-family fermion mixing
(CKM matrix)

Origin of Matter-Antimatter Asymmetry

Sakharov Conditions (for dynamical generation of baryon asymmetry)

In the
SM?

- B Violation ✓ (Sphalerons) (non-perturbative, high-temperature)
- C/CP Violation ✗
- Departure from Thermal Equilibrium ✗ not enough*

*The EW Phase Transition in SM is smooth, no out-of-equilibrium
(crossover)

(*The EW Phase Transition in SM is smooth, no out-of-equilibrium)

Higgs Evolution
in Early Universe



Finite-Temperature Effective Potential

$$V_{\text{eff}}(h, T) = V_0(h) + V_0^{\text{loop}}(h) + V_T(h, T)$$

Tree-level
potential

Loop
corrections

Thermal
corrections

(*The EW Phase Transition in SM is smooth, no out-of-equilibrium)

Higgs Evolution
in Early Universe



Finite-Temperature Effective Potential

$$V_{\text{eff}}(h, T) = V_0(h) + V_0^{\text{loop}}(h) + V_T(h, T)$$

Tree-level
potential

Loop
corrections

Thermal
corrections

(Perturbative) Nature of EW Phase Transition

1st Order:

$\langle h \rangle = 0 \rightarrow \langle h \rangle = h(T)$ Discontinuous

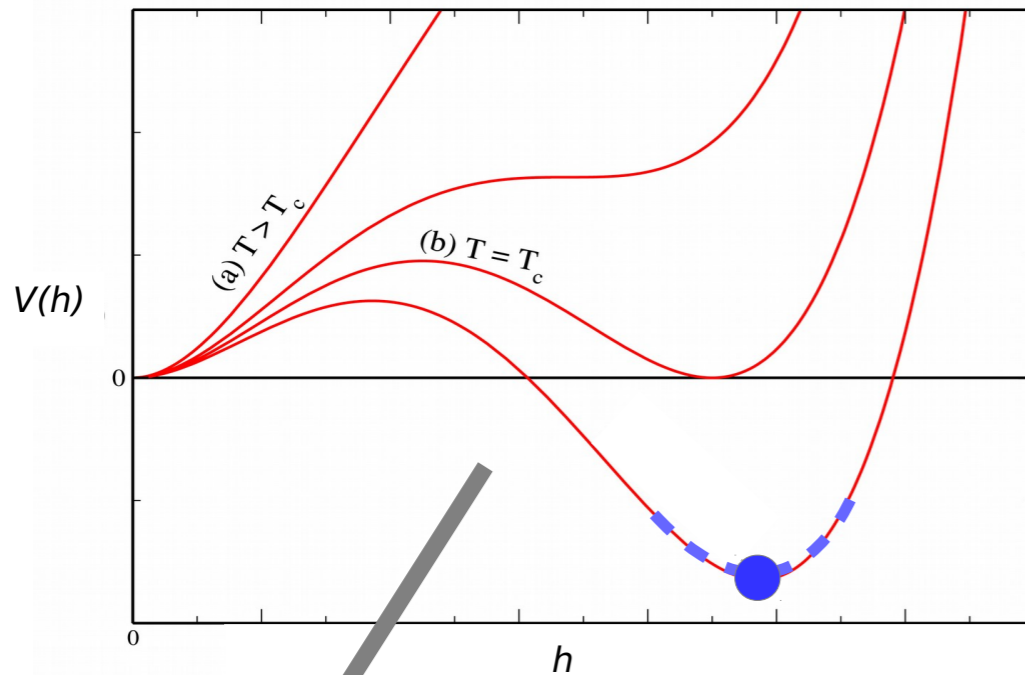

2nd Order:

$\langle h \rangle = 0 \rightarrow \langle h \rangle = h(T)$ Continuous

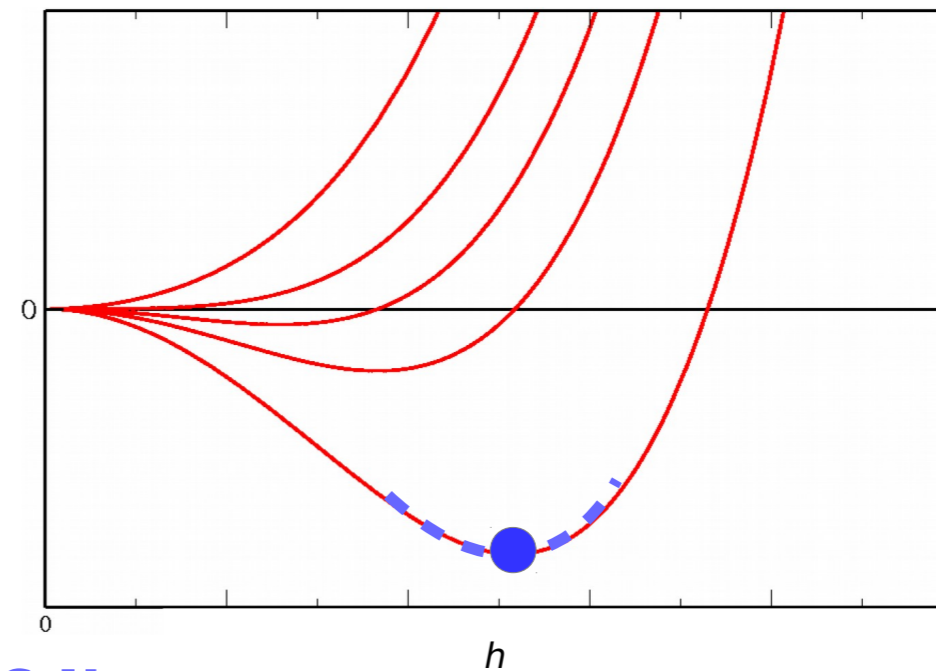

$$v = 246 \text{ GeV}$$

$$m_h = 125 \text{ GeV}$$

Out-of-equilibrium

(*The EW Phase Transition in SM is smooth, no out-of-equilibrium)

Higgs Evolution
in Early Universe



Finite-Temperature Effective Potential

$$V_{\text{eff}}(h, T) = V_0(h) + V_0^{\text{loop}}(h) + V_T(h, T)$$

Tree-level
potential

Loop
corrections

Thermal
corrections

(Perturbative) Nature of EW Phase Transition

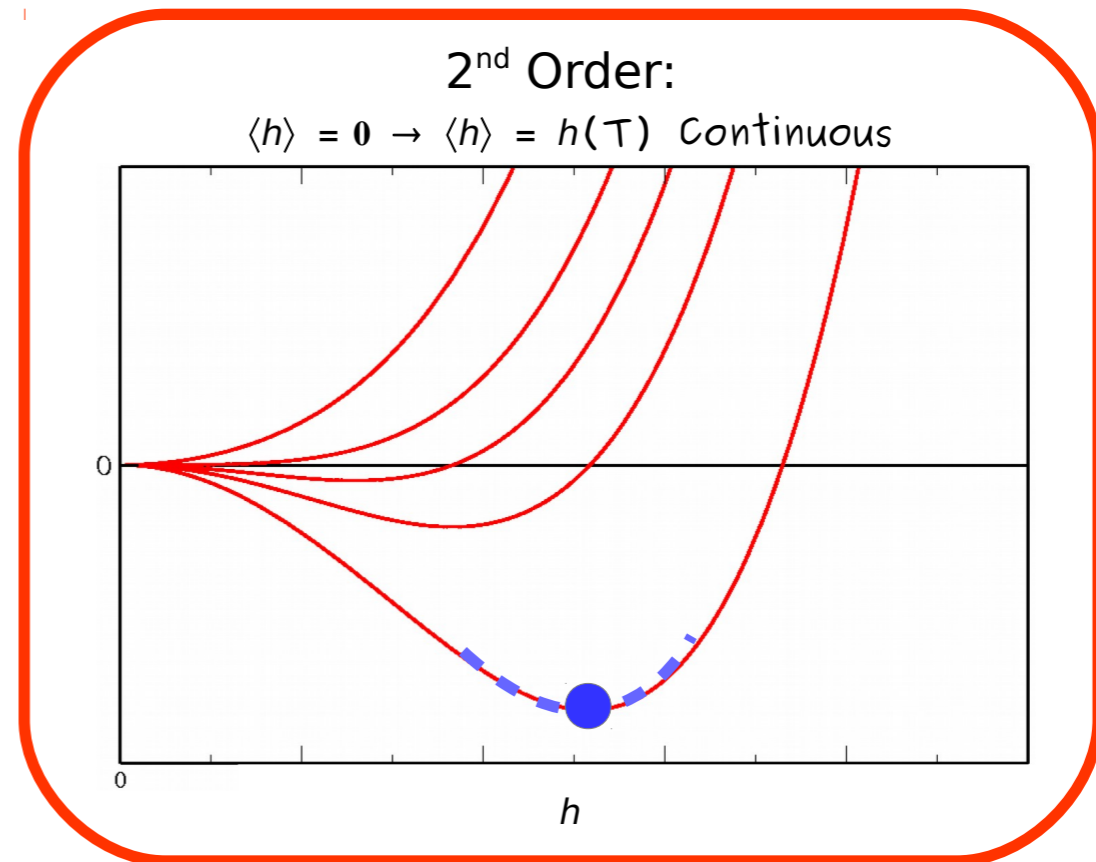
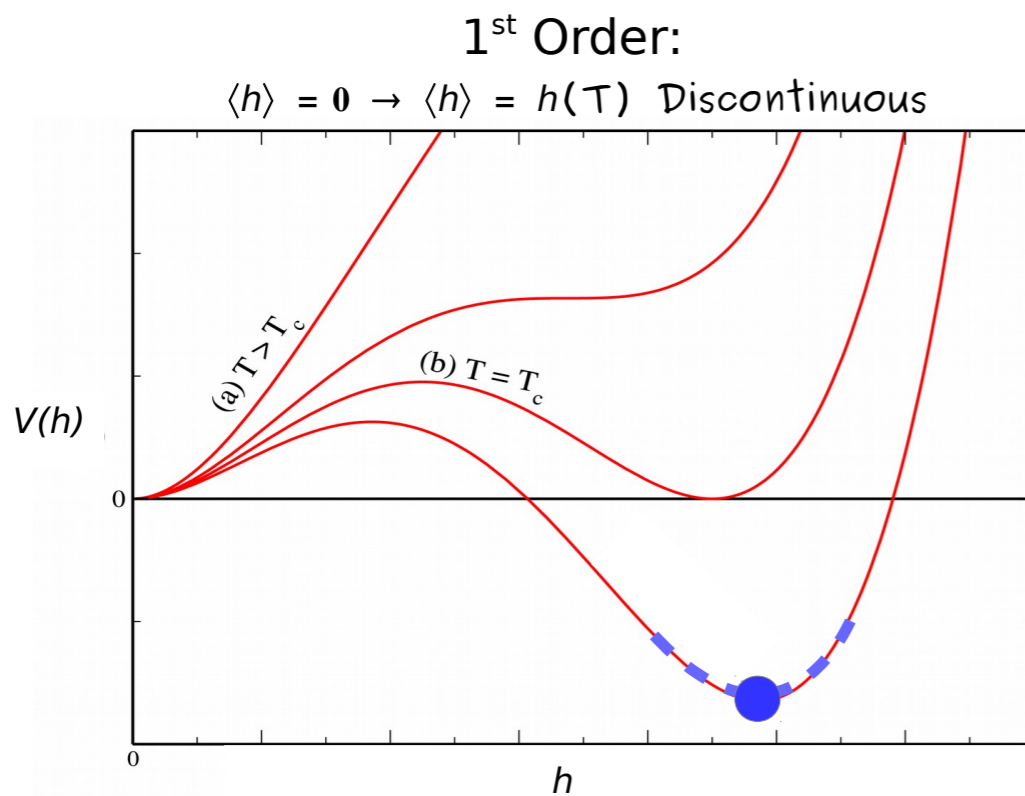

In the SM...

(*The EW Phase Transition in SM is smooth, no out-of-equilibrium)

Higgs Evolution
in Early Universe



Finite-Temperature Effective Potential

$$V_{\text{eff}}(h, T) = V_0(h) + V_0^{\text{loop}}(h) + V_T(h, T)$$

Tree-level
potential

Loop
corrections

Thermal
corrections

(Perturbative) Nature of EW Phase Transition

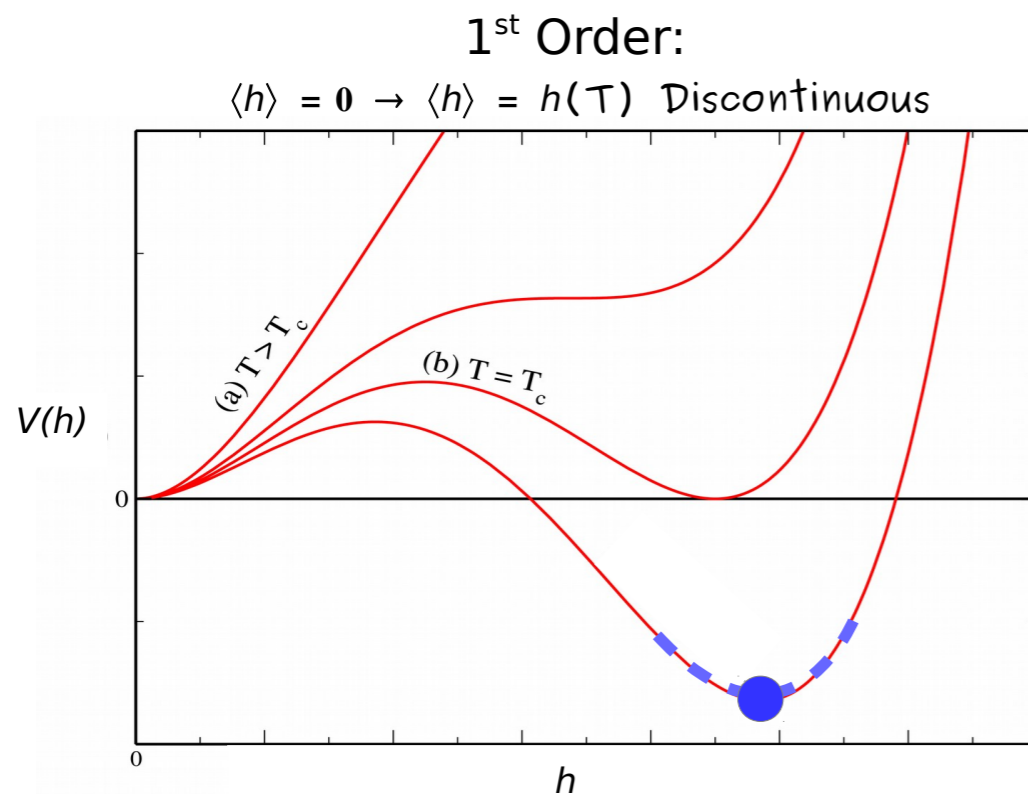

BSM can induce 1st Order Phase Transition

Non-Minimal Higgs sectors can yield 1st order EW phase transition

(multi-scalar dynamics in early Universe)

e.g. **Higgs + singlet** (Espinosa, Quiros 93, Choi, Volkas 93, Profumo, Ramsey-Musolf, Shaughnessy 07, Noble, Perelstein 07, Espinosa, Konstandin, No, Quiros 08, Barger, Langacker, McCaskey, Ramsey-Musolf, Shaughnessy 09, Ashoorioon, Konstandin 09, Espinosa, Konstandin, Riva 11, Barger, Chung, Long, Wang 12, Fairbairn, Hogan 13, Katz, Perelstein 14, Profumo, Ramsey-Musolf, Wainwright, Winslow 14... + many more recently!)

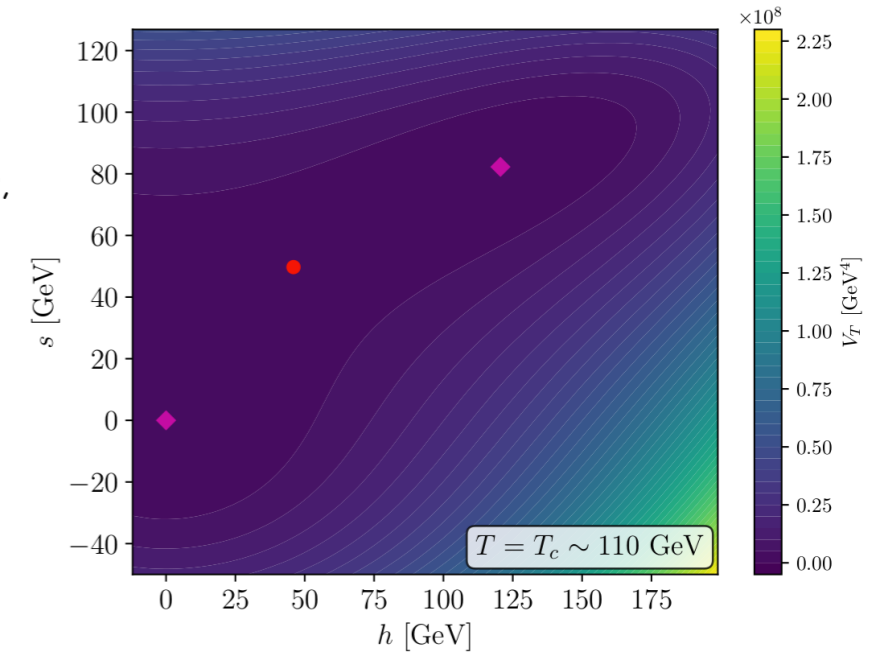

Fernández-Martínez, López-Pavón, JMN, Ota, Rosauero-Alcaraz, 2210.16279

e.g. **2HDM** (Turok, Zadrozny 92, Cline, Lemieux 97, Froome, Huber, Seniuch 06, Cline, Kainulainen, Trott 11, Dorsch, Huber, No 13, Dorsch, Huber, Mimasu, No 14, Basler, Krause, Muhlleitner, Wittbrodt, Wlotzka 16, Dorsch, Huber, Mimasu, No 17, Bernon, Bian, Jiang 17... + many more recently!)

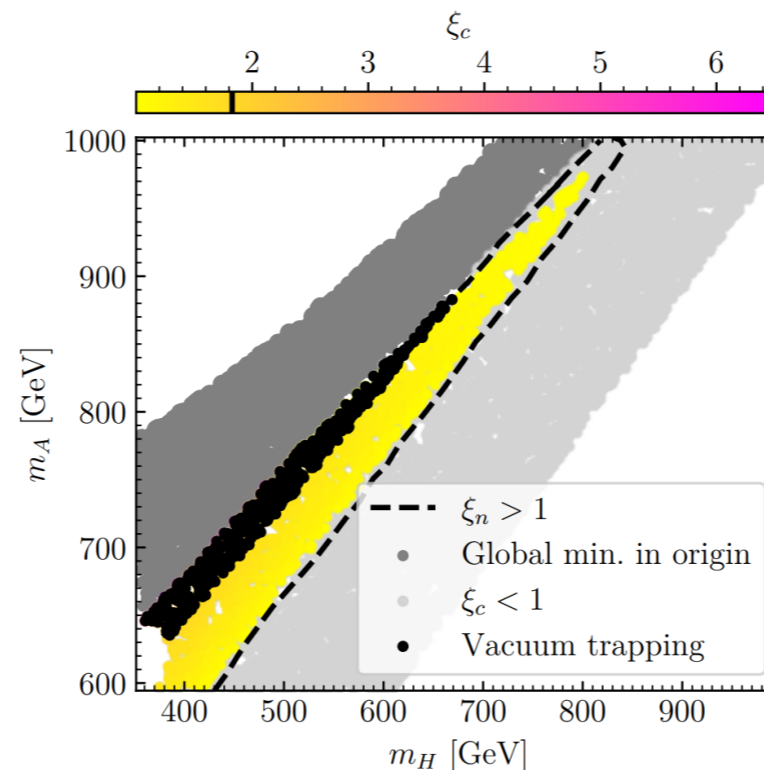

Biekotter, Heinemeyer, JMN, Olea, Weiglein, JCAP 03 (2023), 031

What about CPV? (*SM CP Violation insufficient)

Non-Minimal Higgs sectors can yield BSM CP Violation
(complex parameters)



e.g. Two-Higgs-Doublet-Model

$$V_{2\text{HDM}} = \mu_1^2 |H_1|^2 + \mu_2^2 |H_2|^2 - [\mu_{12}^2 H_1^\dagger H_2 + \text{h.c.}] \\ + \frac{\lambda_1}{2} |H_1|^4 + \frac{\lambda_2}{2} |H_2|^4 + \lambda_3 |H_1|^2 |H_2|^2 \\ + \lambda_4 |H_1^\dagger H_2|^2 + \frac{1}{2} [\lambda_5 (H_1^\dagger H_2)^2 + \text{h.c.}]$$

Phase of $\lambda_5^* (\mu_{12}^2)^2$ is physical \rightarrow CPV

What about CPV? (*SM CP Violation insufficient)

Non-Minimal Higgs sectors can yield BSM CP Violation
(complex parameters)

BSM CP Violation (very) strongly constrained by electric dipole moments!
(EDM experimental searches)



$$\frac{|d_e|}{e} < 1.1 \times 10^{-29} \text{ cm}$$

Andreev et al (ACME Collaboration), Nature **562** (2018) 7727

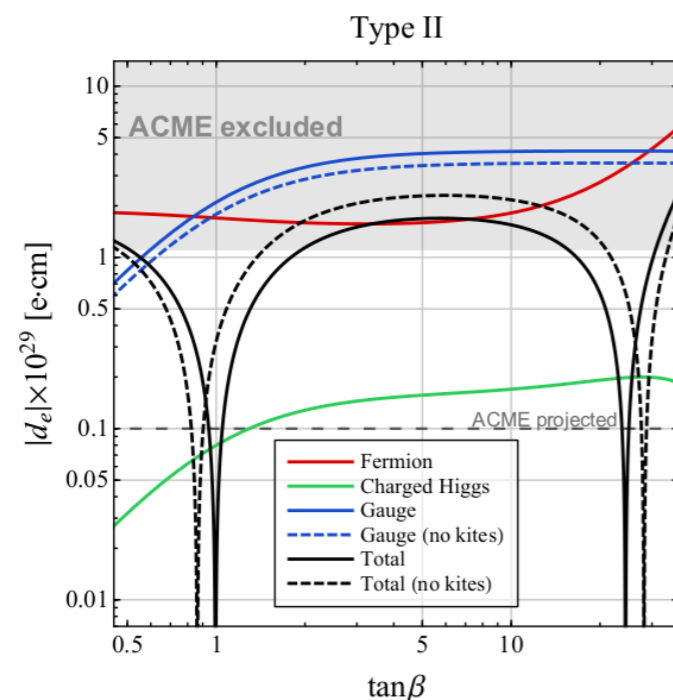

e.g. 2HDM

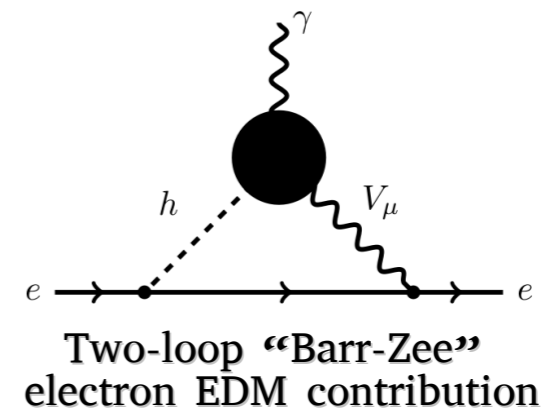

Altmannshofer, Gori, Hamer, Patel, Phys. Rev. D **102** (2020) 115042

What about CPV? (*SM CP Violation insufficient)

Non-Minimal Higgs sectors can yield BSM CP Violation
(complex parameters)

BSM CP Violation (very) strongly constrained by electric dipole moments!
(EDM experimental searches)



$$\frac{|d_e|}{e} < 1.1 \times 10^{-29} \text{ cm}$$

Andreev et al (ACME Collaboration), Nature **562** (2018) 7727



e.g. 2HDM

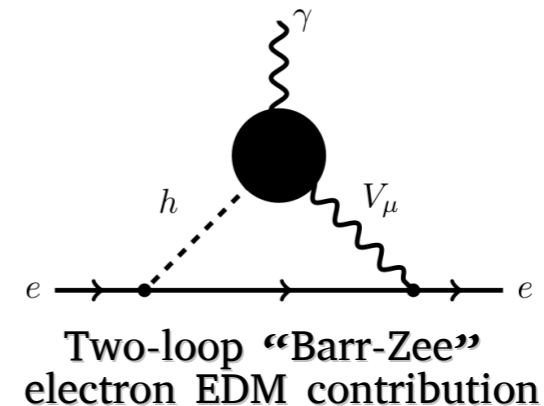

Altmannshofer, Gori, Hamer, Patel, Phys. Rev. D **102** (2020) 115042

CPV: biggest challenge for successful EW Baryogenesis

Can Higgs sector help circumvent EDM Constraints?

Non-Minimal Higgs sector inducing
CP Violation in early Universe?



Can Higgs sector help circumvent EDM Constraints?

Non-Minimal Higgs sector inducing
CP Violation in early Universe?



[courtesy of Wikipedia]

Finally!

Can Higgs sector help circumvent EDM Constraints?



Non-Minimal Higgs sector inducing
CP Violation in early Universe?

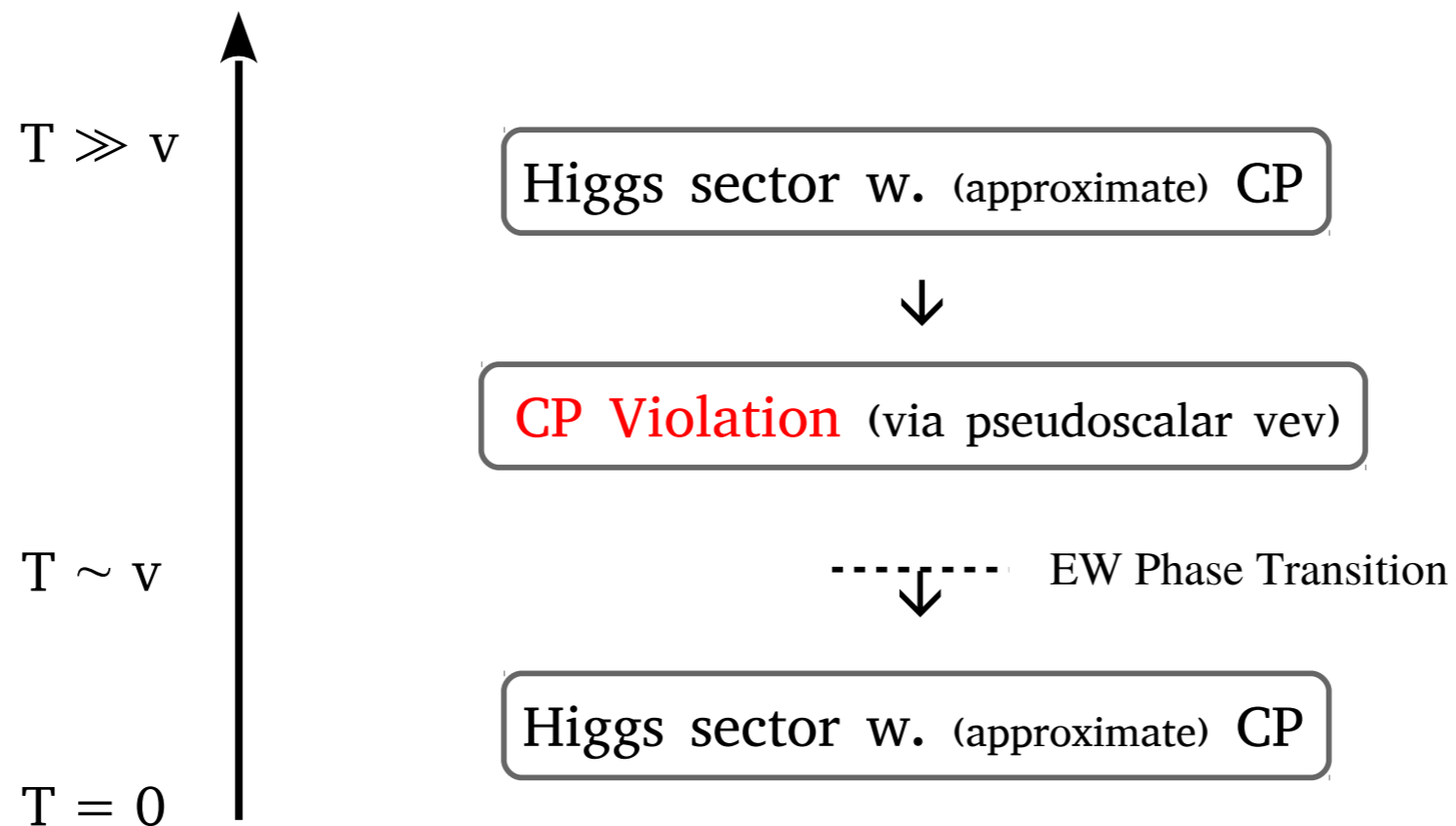

Explicit realization: 2HDM + a

Huber, Mimasu, JMN, PRD 107 (2023) 07542

(Two Higgs doublets + singlet pseudoscalar) $V = V_{2\text{HDM}} + V_a$

$$V_a = \frac{\mu_a^2}{2} a^2 + \frac{\lambda_a}{4} a^4 + \left(i \kappa a H_1^\dagger H_2 + \text{h.c.} \right) \\ + \lambda_{aH_1} a^2 |H_1|^2 + \lambda_{aH_2} a^2 |H_2|^2$$

$$V_{2\text{HDM}} = \mu_1^2 |H_1|^2 + \mu_2^2 |H_2|^2 - \left[\mu_{12}^2 H_1^\dagger H_2 + \text{h.c.} \right] \\ + \frac{\lambda_1}{2} |H_1|^4 + \frac{\lambda_2}{2} |H_2|^4 + \lambda_3 |H_1|^2 |H_2|^2 \\ + \lambda_4 \left| H_1^\dagger H_2 \right|^2 + \frac{1}{2} \left[\lambda_5 \left(H_1^\dagger H_2 \right)^2 + \text{h.c.} \right]$$

Explicit realization: 2HDM + a

Huber, Mimasu, JMN, PRD 107 (2023) 07542

(Two Higgs doublets + singlet pseudoscalar) $V = V_{2\text{HDM}} + V_a$

$$V_a = \frac{\mu_a^2}{2} a^2 + \frac{\lambda_a}{4} a^4 + \left(i \kappa a H_1^\dagger H_2 + \text{h.c.} \right) + \lambda_{aH_1} a^2 |H_1|^2 + \lambda_{aH_2} a^2 |H_2|^2$$

$$V_{2\text{HDM}} = \mu_1^2 |H_1|^2 + \mu_2^2 |H_2|^2 - \left[\mu_{12}^2 H_1^\dagger H_2 + \text{h.c.} \right] + \frac{\lambda_1}{2} |H_1|^4 + \frac{\lambda_2}{2} |H_2|^4 + \lambda_3 |H_1|^2 |H_2|^2 + \lambda_4 \left| H_1^\dagger H_2 \right|^2 + \frac{1}{2} \left[\lambda_5 \left(H_1^\dagger H_2 \right)^2 + \text{h.c.} \right]$$

Singlet-doublet pseudoscalar mixing: $a A_0 \rightarrow a_{1,2}$

Higgs boson coupling to light pseudoscalar: $\lambda_\beta \equiv (\lambda_{aH_1} + \lambda_{aH_2} t_\beta^2)/(1 + t_\beta^2)$

Simplifying parameter assumptions

$$m_{H_0}^2 = m_{A_0}^2 = m_{H^\pm}^2 = M^2 \equiv \mu_{12}^2/(s_\beta c_\beta) \quad (2\text{HDM degenerate spectrum})$$

$$c_{\beta-\alpha} = 0 \quad (2\text{HDM alignment limit})$$

2HDM + a CP Violation

$$V_a = \frac{\mu_a^2}{2} a^2 + \frac{\lambda_a}{4} a^4 + (i \kappa a H_1^\dagger H_2 + \text{h.c.}) \\ + \lambda_{aH_1} a^2 |H_1|^2 + \lambda_{aH_2} a^2 |H_2|^2$$

$$V_{2\text{HDM}} = \mu_1^2 |H_1|^2 + \mu_2^2 |H_2|^2 - [\mu_{12}^2 H_1^\dagger H_2 + \text{h.c.}] \\ + \frac{\lambda_1}{2} |H_1|^4 + \frac{\lambda_2}{2} |H_2|^4 + \lambda_3 |H_1|^2 |H_2|^2 \\ + \lambda_4 |H_1^\dagger H_2|^2 + \frac{1}{2} [\lambda_5 (H_1^\dagger H_2)^2 + \text{h.c.}]$$

- Besides $\lambda_5^* (\mu_{12}^2)^2$, **more CPV phases:** e.g. $\kappa^* \mu_{12}^2$

2HDM + a CP Violation

$$V_a = \frac{\mu_a^2}{2} a^2 + \frac{\lambda_a}{4} a^4 + (i \kappa a H_1^\dagger H_2 + \text{h.c.}) \\ + \lambda_{aH_1} a^2 |H_1|^2 + \lambda_{aH_2} a^2 |H_2|^2$$

$$V_{2\text{HDM}} = \mu_1^2 |H_1|^2 + \mu_2^2 |H_2|^2 - [\mu_{12}^2 H_1^\dagger H_2 + \text{h.c.}] \\ + \frac{\lambda_1}{2} |H_1|^4 + \frac{\lambda_2}{2} |H_2|^4 + \lambda_3 |H_1|^2 |H_2|^2 \\ + \lambda_4 |H_1^\dagger H_2|^2 + \frac{1}{2} [\lambda_5 (H_1^\dagger H_2)^2 + \text{h.c.}]$$

- For $\lambda_5, \mu_{12}^2, \kappa \in \mathbb{R}$, CP Conservation!
(if $\langle a \rangle = 0$)

2HDM + a CP Violation

$$V_a = \frac{\mu_a^2}{2} a^2 + \frac{\lambda_a}{4} a^4 + \left(i \kappa a H_1^\dagger H_2 + \text{h.c.} \right) \\ + \lambda_{aH_1} a^2 |H_1|^2 + \lambda_{aH_2} a^2 |H_2|^2$$

$$V_{2\text{HDM}} = \mu_1^2 |H_1|^2 + \mu_2^2 |H_2|^2 - \left[\mu_{12}^2 H_1^\dagger H_2 + \text{h.c.} \right] \\ + \frac{\lambda_1}{2} |H_1|^4 + \frac{\lambda_2}{2} |H_2|^4 + \lambda_3 |H_1|^2 |H_2|^2 \\ + \lambda_4 \left| H_1^\dagger H_2 \right|^2 + \frac{1}{2} \left[\lambda_5 \left(H_1^\dagger H_2 \right)^2 + \text{h.c.} \right]$$

- For $\lambda_5, \mu_{12}^2, \kappa \in \mathbb{R}$, CP Conservation!

(if $\langle a \rangle = 0$)

If non-zero vev, CP Violation!

Possible to switch-on & switch-off $\langle a \rangle$ in early Universe

“Transient CPV”

2HDM + a CP Violation

$$V_a = \frac{\mu_a^2}{2} a^2 + \frac{\lambda_a}{4} a^4 + \left(i \kappa a H_1^\dagger H_2 + \text{h.c.} \right) + \lambda_{aH_1} a^2 |H_1|^2 + \lambda_{aH_2} a^2 |H_2|^2$$

$$V_{2\text{HDM}} = \mu_1^2 |H_1|^2 + \mu_2^2 |H_2|^2 - \left[\mu_{12}^2 H_1^\dagger H_2 + \text{h.c.} \right] + \frac{\lambda_1}{2} |H_1|^4 + \frac{\lambda_2}{2} |H_2|^4 + \lambda_3 |H_1|^2 |H_2|^2 + \lambda_4 \left| H_1^\dagger H_2 \right|^2 + \frac{1}{2} \left[\lambda_5 \left(H_1^\dagger H_2 \right)^2 + \text{h.c.} \right]$$

- For $\lambda_5, \mu_{12}^2, \kappa \in \mathbb{R}$, CP Conservation!
(if $\langle a \rangle = 0$)

If non-zero vev, CP Violation!

Possible to **switch-on** & **switch-off** $\langle a \rangle$ in early Universe

“Transient CPV”

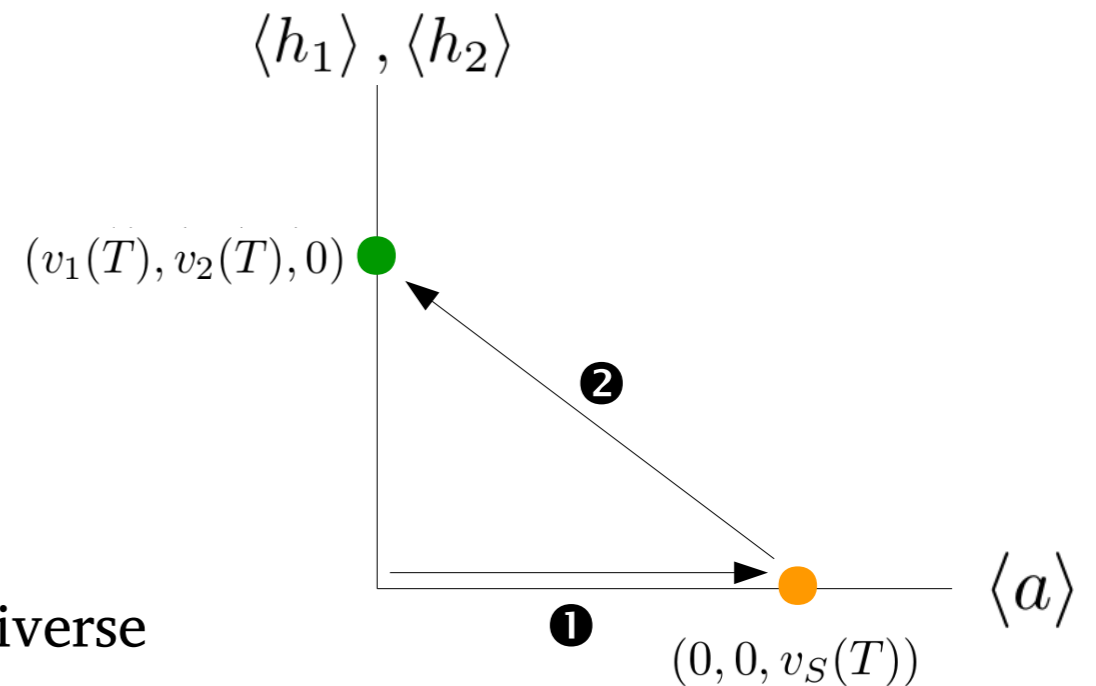

Transient CPV:

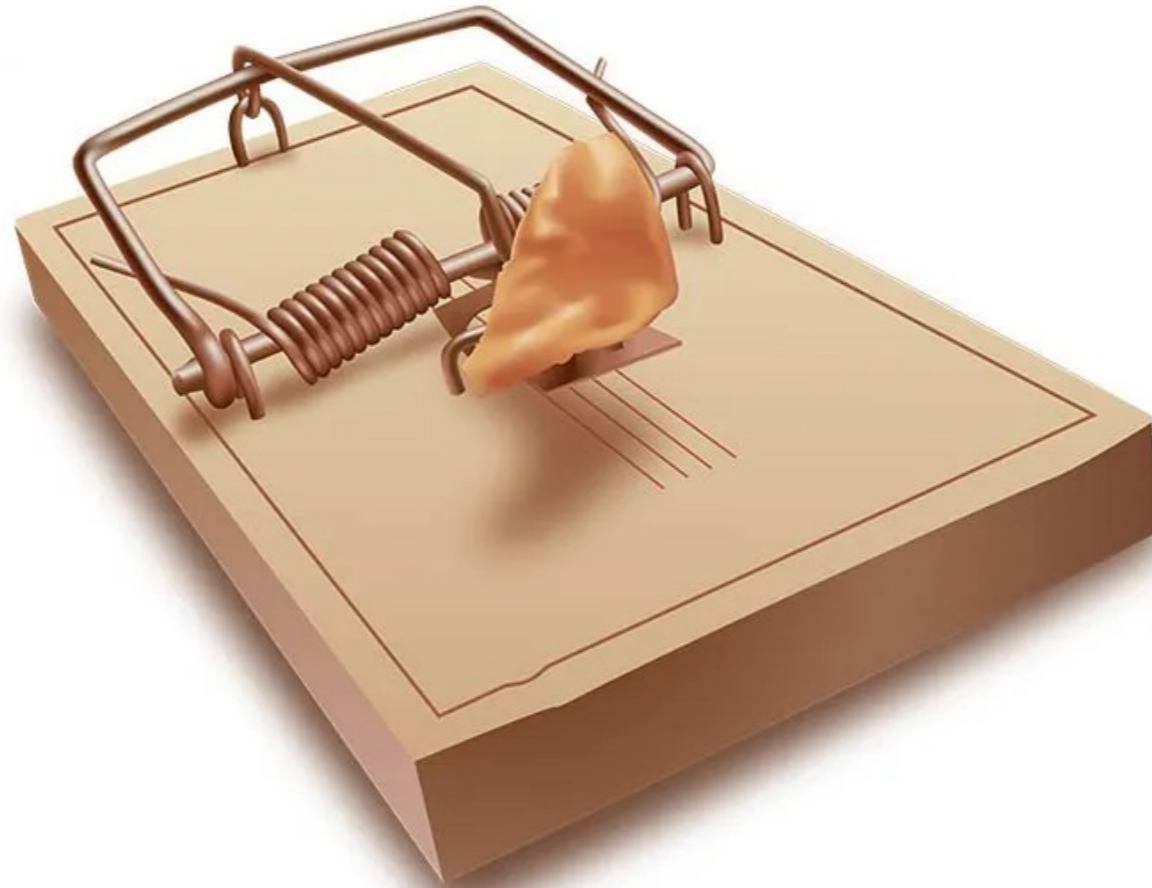

***There is no
Free Lunch.***

©Joel Wagner

Transient CPV: Requirements (I)

$$V_a = \frac{\mu_a^2}{2} a^2 + \frac{\lambda_a}{4} a^4 + \left(i \kappa a H_1^\dagger H_2 + \text{h.c.} \right) + \lambda_{aH_1} a^2 |H_1|^2 + \lambda_{aH_2} a^2 |H_2|^2$$

T = 0

- $\mu_a^2 < 0$ (needed for $\langle a \rangle \neq 0$ at $T > 0$)
- $\mu_a^2 + (\lambda_{aH_1} v_1^2 + \lambda_{aH_2} v_2^2) > 0$ (yields $\langle a \rangle = 0$ at $T = 0$)

$$v_{1,2} = \sqrt{2} \langle H_{1,2} \rangle$$

- EW vacuum deepest minimum at $T = 0$

Transient CPV: Requirements (II)

$$V_a = \frac{\mu_a^2}{2} a^2 + \frac{\lambda_a}{4} a^4 + \left(i \kappa a H_1^\dagger H_2 + \text{h.c.} \right) + \lambda_{aH_1} a^2 |H_1|^2 + \lambda_{aH_2} a^2 |H_2|^2$$

T > 0 (2HDM + *a* thermal history)

We add thermal $\mathcal{O}(T^2)$ corrections to scalar potential:

$$V_T = \frac{T^2}{24} \sum_b n_b M_b^2 + \frac{T^2}{48} \sum_f n_f M_f^2$$

Background-field dependent masses

▷ CP breaking ($\langle a \rangle \neq 0$) @ T_S

$$T_S^2 = 12 |\mu_a^2| / (4 \lambda_{aH_1} + 4 \lambda_{aH_2} + 3 \lambda_a)$$

▷ EW breaking @ T_h

$$T_h^2 \simeq 6 m_h^2 v^2 / (5m_h^2 + \lambda_\beta v^2 + 6m_W^2 + 3m_Z^2 + 6m_t^2)$$

Transient CPV: Requirements (II)

$$V_a = \frac{\mu_a^2}{2} a^2 + \frac{\lambda_a}{4} a^4 + \left(i \kappa a H_1^\dagger H_2 + \text{h.c.} \right) + \lambda_{aH_1} a^2 |H_1|^2 + \lambda_{aH_2} a^2 |H_2|^2$$

$T > 0$ (2HDM + a thermal history)

We add thermal $\mathcal{O}(T^2)$ corrections to scalar potential:

$$V_T = \frac{T^2}{24} \sum_b n_b M_b^2 + \frac{T^2}{48} \sum_f n_f M_f^2$$

- $T_S > T_h$

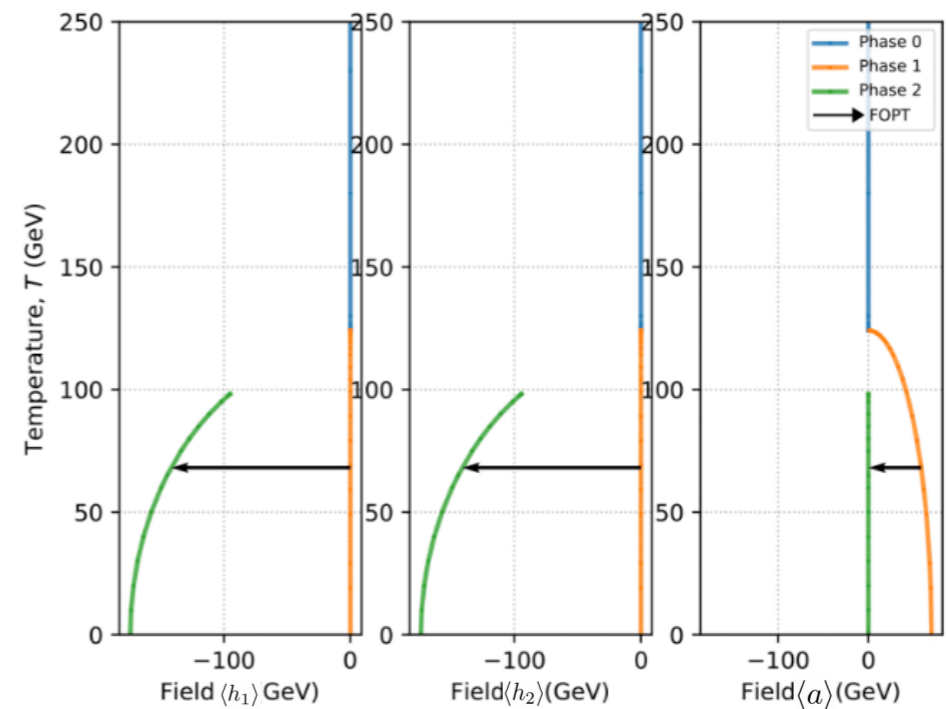
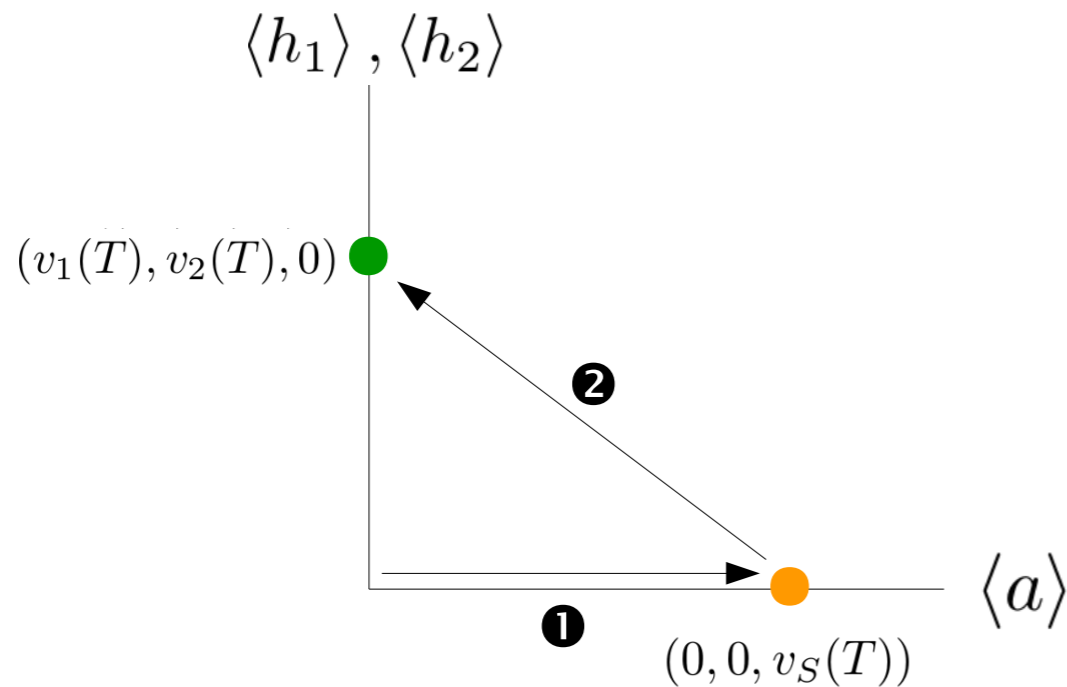

[courtesy of Jose Manuel Cano]

Transient CPV: I + II

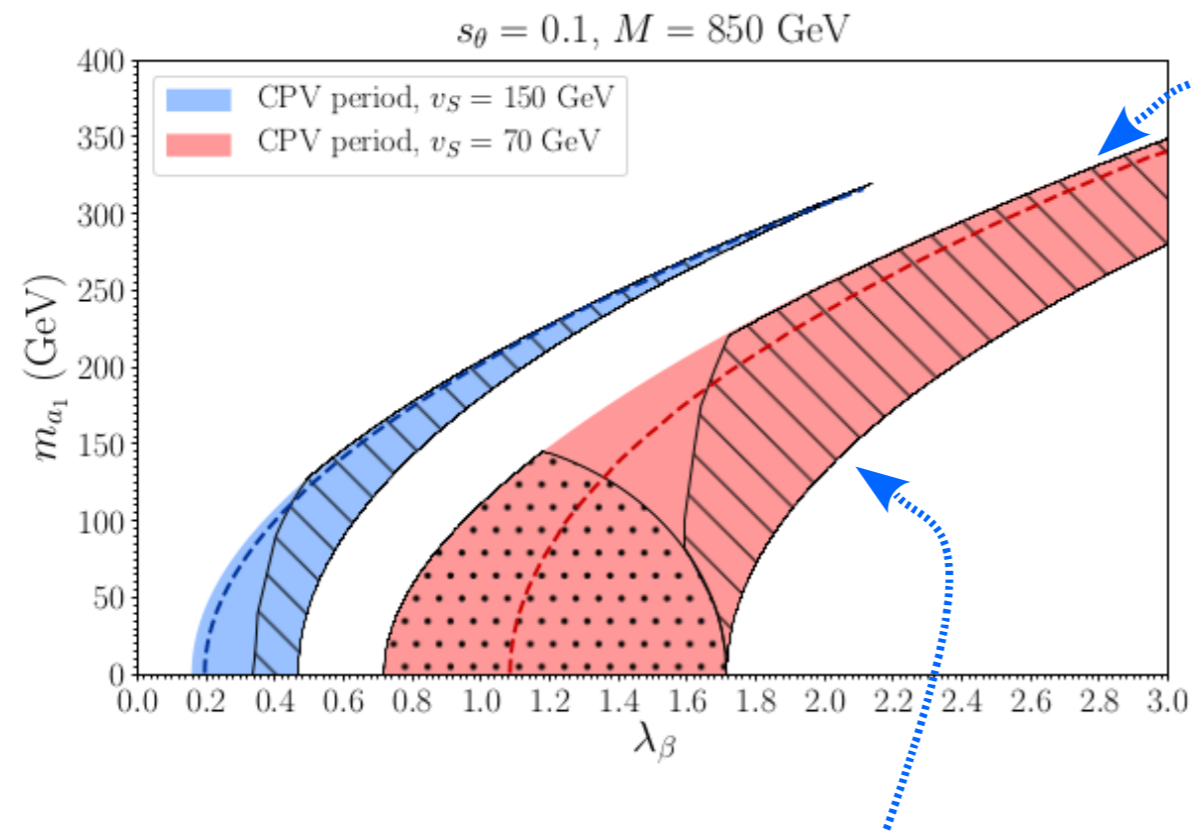

EW vacuum deepest @ $T = 0$

$T_S > T_h$

$$m_{a_1, \max}^2 = \frac{1}{c_\theta^2 - s_\theta^2} [c_\theta^2 v^2 \lambda_\beta (1 - F) - s_\theta^2 M^2]$$

$$F = \frac{(4\lambda_{aH_1} + 4\lambda_{aH_2} + 3\lambda_a) m_h^2}{2(5m_h^2 + \lambda_\beta v^2 + 6m_W^2 + 3m_Z^2 + 6m_t^2)}$$

Transient CPV: I + II

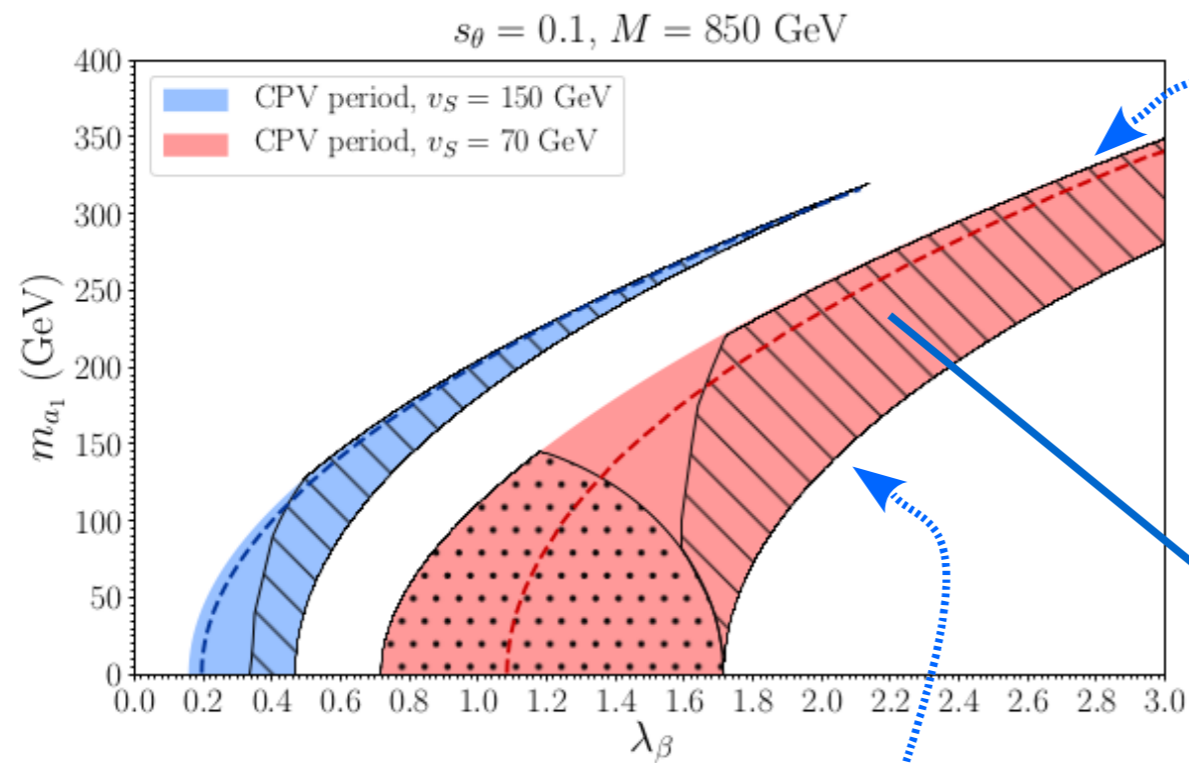

EW vacuum deepest @ $T = 0$

$$T_S > T_h$$

$$m_{a_1, \text{max}}^2 = \frac{1}{c_\theta^2 - s_\theta^2} [c_\theta^2 v^2 \lambda_\beta (1 - F) - s_\theta^2 M^2]$$

$$F = \frac{(4\lambda_{aH_1} + 4\lambda_{aH_2} + 3\lambda_a) m_h^2}{2(5m_h^2 + \lambda_\beta v^2 + 6m_W^2 + 3m_Z^2 + 6m_t^2)}$$

Universe trapped at $T = 0$ in CPV vacuum (unphysical!)

Transient CPV: I + II

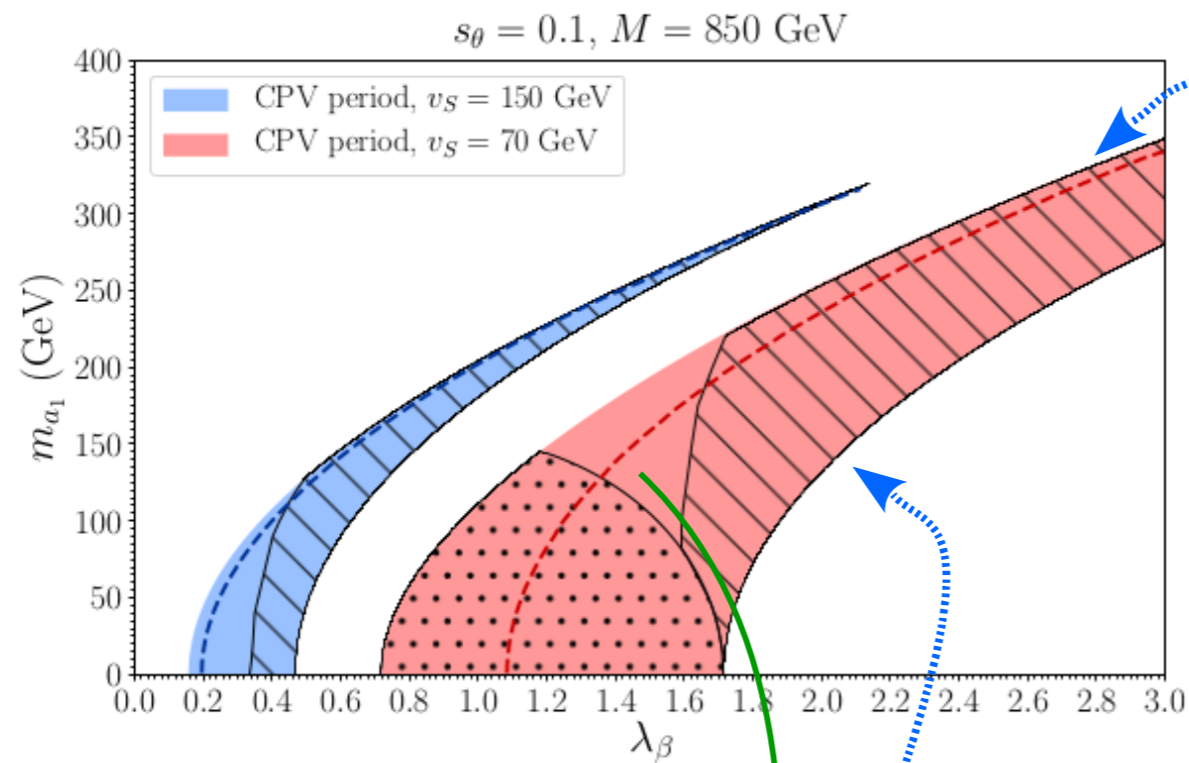

$$T_S > T_h$$

$$m_{a_1, \max}^2 = \frac{1}{c_\theta^2 - s_\theta^2} [c_\theta^2 v^2 \lambda_\beta (1 - F) - s_\theta^2 M^2]$$

$$F = \frac{(4\lambda_{aH_1} + 4\lambda_{aH_2} + 3\lambda_a) m_h^2}{2(5m_h^2 + \lambda_\beta v^2 + 6m_W^2 + 3m_Z^2 + 6m_t^2)}$$

EW vacuum deepest @ $T = 0$

Successful transient CPV needs light singlet-like pseudoscalar

2HDM + a : Baryogenesis vs LHC

$M = 400 \text{ GeV}$, $v_S = 130 \text{ GeV}$, $\lambda_{aH_2} = 5 \lambda_{aH_1} = 0.5$, $t_\beta = 3$

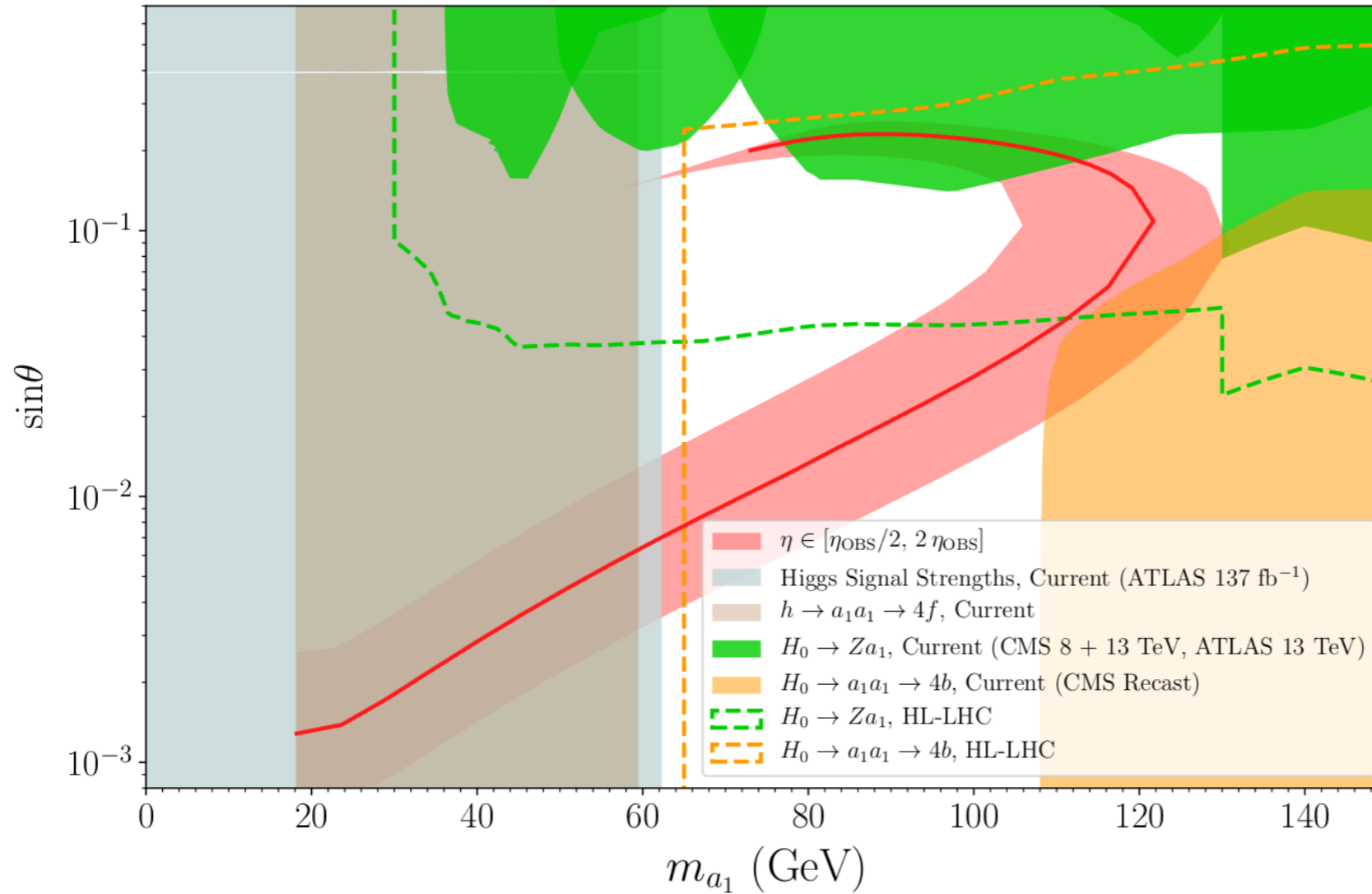

$$\eta \in [\eta_{\text{OBS}}/2, 2\eta_{\text{OBS}}]$$

$$\frac{\eta}{10^{-11}} \sim 6 \times 10^2 \frac{\sin(\delta_t) \xi_c^2}{L_W T_c}$$

$$\eta_{\text{OBS}} = 8.7 \times 10^{-11}$$

Fromme, Huber, JHEP 03 (2007), 049

2HDM + a : Baryogenesis vs **LHC**

$M = 400 \text{ GeV}, v_S = 130 \text{ GeV}, \lambda_{aH_2} = 5 \lambda_{aH_1} = 0.5, t_\beta = 3$

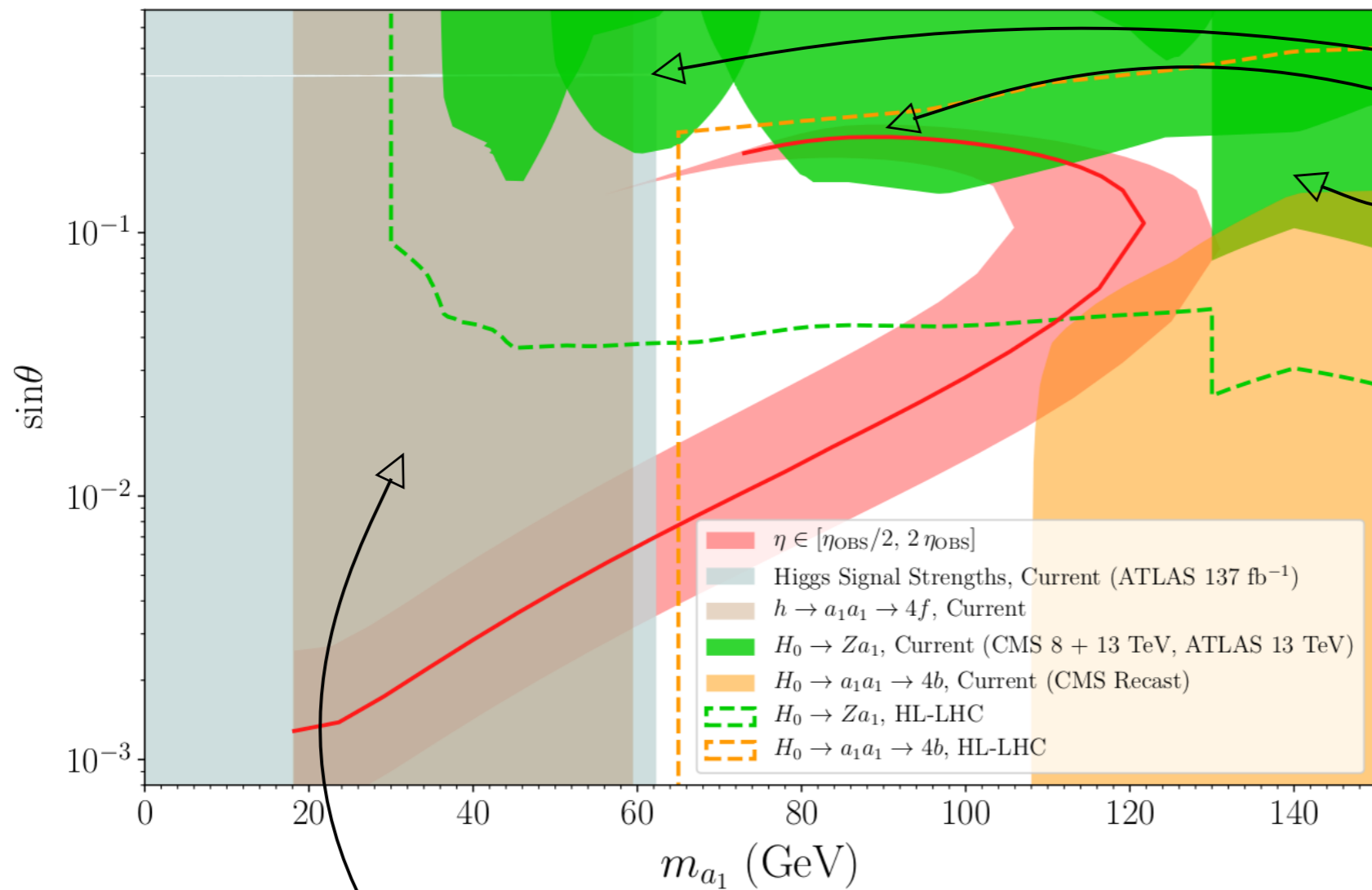

$H_0 \rightarrow Z a_1 \rightarrow \ell \bar{\ell} b \bar{b}$

CMS, Phys. Lett. B 759 (2016), 369 (8 TeV)

CMS-PAS-HIG-18-012 (13 TeV)

ATLAS, Phys. Lett. B 783 (2018), 392 (13 TeV)

- $\eta \in [\eta_{\text{OBS}}/2, 2\eta_{\text{OBS}}]$
- Higgs Signal Strengths, Current (ATLAS 137 fb⁻¹)
- $h \rightarrow a_1 a_1 \rightarrow 4f$, Current
- $H_0 \rightarrow Z a_1$, Current (CMS 8 + 13 TeV, ATLAS 13 TeV)
- $H_0 \rightarrow a_1 a_1 \rightarrow 4b$, Current (CMS Recast)
- - - $H_0 \rightarrow Z a_1$, HL-LHC
- - - $H_0 \rightarrow a_1 a_1 \rightarrow 4b$, HL-LHC

RULED OUT
(LHC Higgs signal strengths)

2HDM + a : Baryogenesis vs **LHC**

$M = 400 \text{ GeV}, v_S = 130 \text{ GeV}, \lambda_{aH_2} = 5 \lambda_{aH_1} = 0.5, t_\beta = 3$

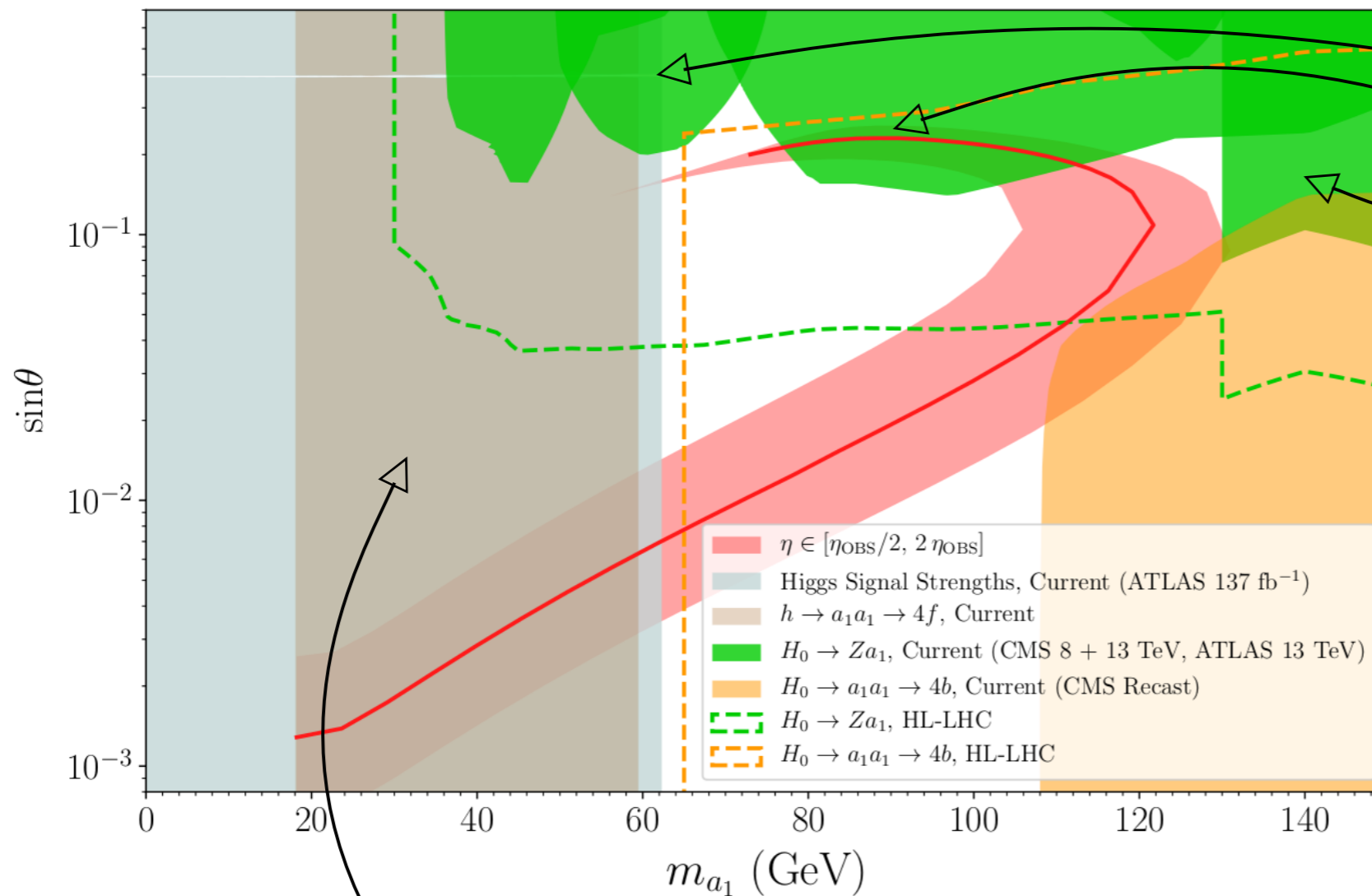

$H_0 \rightarrow Z a_1 \rightarrow \ell \bar{\ell} b \bar{b}$

CMS, Phys. Lett. B 759 (2016), 369 (8 TeV)

CMS-PAS-HIG-18-012 (13 TeV)

ATLAS, Phys. Lett. B 783 (2018), 392 (13 TeV)

$A \rightarrow Z H / H \rightarrow Z A$ searches were originally targeting baryogenesis in 2HDM!

Dorsch, Huber, Mimasu, JMN, PRL 113 (2014) 211802

ATLAS more sensitive (more lumi), yet no quoted limit below 130 GeV

$$\Gamma(H_0 \rightarrow Z a_1) \propto s_\theta^2$$

RULED OUT
(LHC Higgs signal strengths)

2HDM + a : Baryogenesis vs **LHC**

$M = 400 \text{ GeV}, v_S = 130 \text{ GeV}, \lambda_{aH_2} = 5 \lambda_{aH_1} = 0.5, t_\beta = 3$

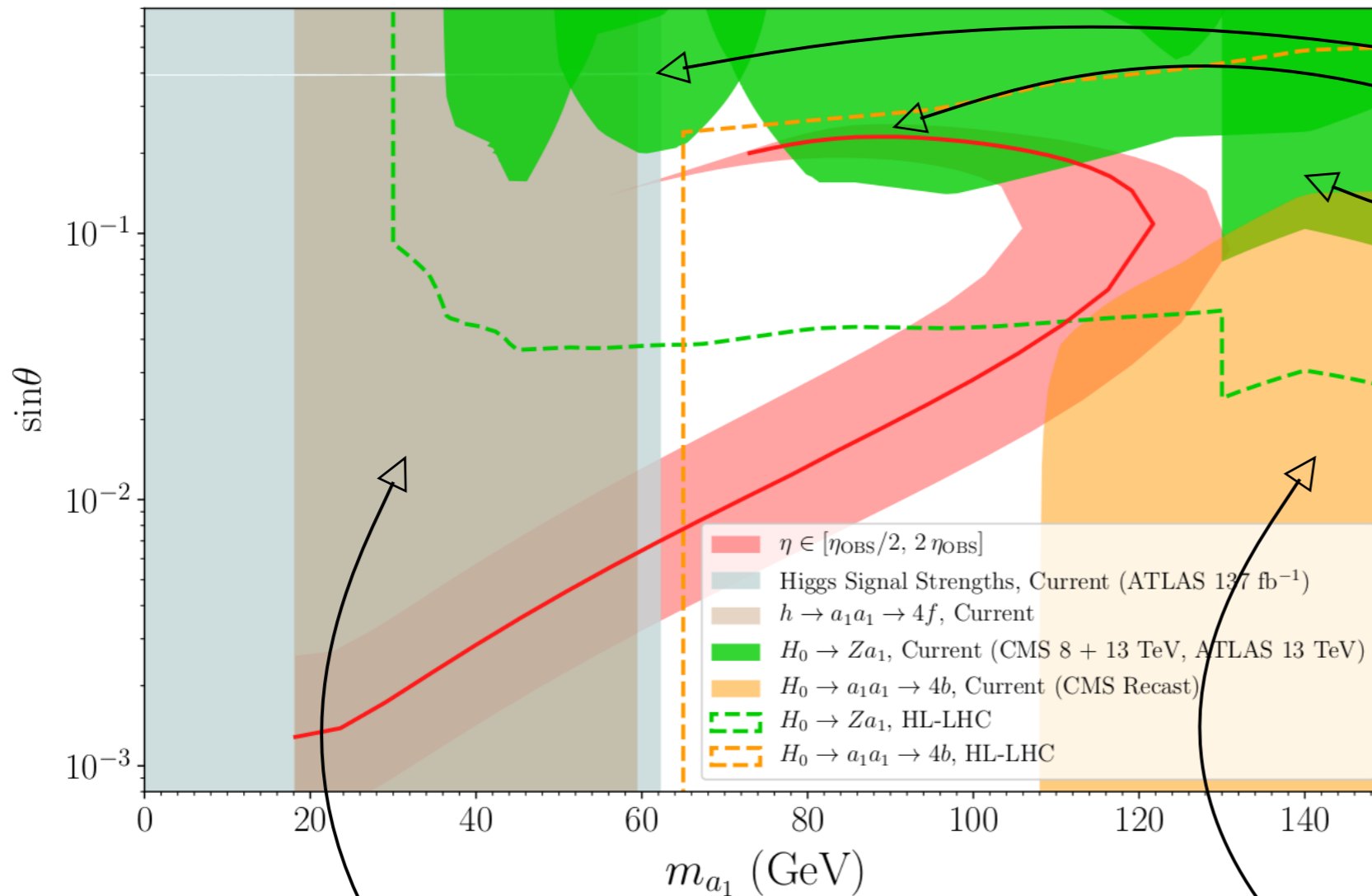

$$H_0 \rightarrow Z a_1 \rightarrow \ell \bar{\ell} b \bar{b}$$

CMS, Phys. Lett. B 759 (2016), 369 (8 TeV)
CMS-PAS-HIG-18-012 (13 TeV)
ATLAS, Phys. Lett. B 783 (2018), 392 (13 TeV)

$A \rightarrow Z H / H \rightarrow Z A$ searches were originally targeting baryogenesis in 2HDM!

Dorsch, Huber, Mimasu, JMN, PRL 113 (2014) 211802

ATLAS more sensitive (more lumi), yet no quoted limit below 130 GeV

$$\Gamma(H_0 \rightarrow Z a_1) \propto s_\theta^2$$

RULED OUT
(LHC Higgs signal strengths)

$$H_0 \rightarrow a_1 a_1 \rightarrow b \bar{b} b \bar{b}$$

CMS, JHEP 08 (2018), 152 (13 TeV)

Limits are recast of $H \rightarrow hh$ CMS search

Barducci, Mimasu, JMN, Vernieri, Zurita, JHEP 02 (2020), 002

$$\Gamma(H_0 \rightarrow a_1 a_1) \propto (\lambda_{aH_1} - \lambda_{aH_2})^2 c_\theta^4$$

Summary

- ▷ Early Universe “Transient” CPV: Baryogenesis & No EDM constraints
- ▷ “Transient” CPV requires light (~ 100 GeV) pseudoscalar* & coupled to 125 GeV Higgs boson (& rest of Higgs sector)...

Within LHC reach!

Cascade scalar decays @LHC

$$H_0 \rightarrow a_1 a_1 \rightarrow \bar{b} b \bar{b} b$$

$$H_0 \rightarrow Z a_1 \rightarrow \ell \bar{\ell} b \bar{b}$$

...

Summary

- ▷ Early Universe “Transient” CPV: Baryogenesis & No EDM constraints
- ▷ “Transient” CPV requires light (~ 100 GeV) pseudoscalar* & coupled to 125 GeV Higgs boson (& rest of Higgs sector)...

Within LHC reach!

Cascade scalar decays @LHC

$$H_0 \rightarrow a_1 a_1 \rightarrow \bar{b} b \bar{b} b$$

$$H_0 \rightarrow Z a_1 \rightarrow \ell \bar{\ell} b \bar{b}$$

...

* [In this realization! Other realizations lead to other light states: **Cano, Gori, Mimasu, JMN, 23XX.XXXXXX**]



Summary

- ▷ Early Universe “Transient” CPV: Baryogenesis & No EDM constraints
- ▷ “Transient” CPV requires light (~ 100 GeV) pseudoscalar & coupled to 125 GeV Higgs boson (& rest of Higgs sector)...

Within LHC reach!

Cascade scalar decays @LHC

$$H_0 \rightarrow a_1 a_1 \rightarrow b\bar{b}b\bar{b}$$

$$H_0 \rightarrow Z a_1 \rightarrow \ell\bar{\ell}b\bar{b}$$

...

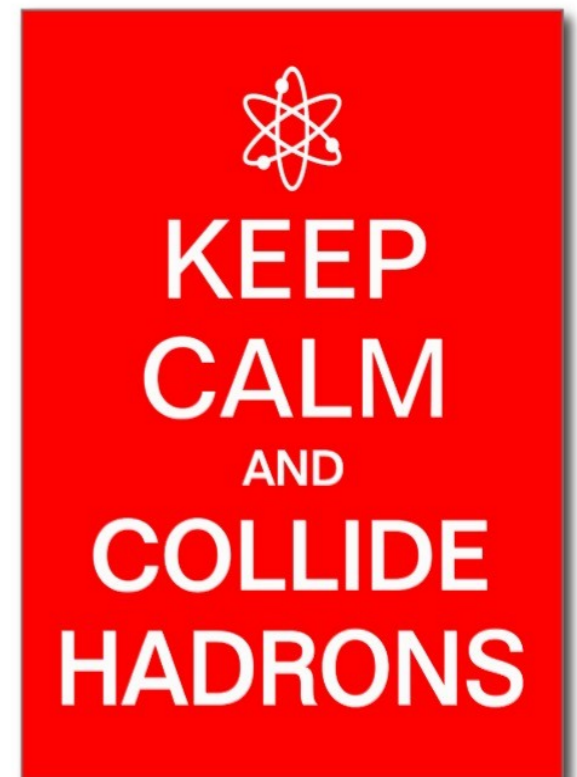

Summary

- ▷ Early Universe “Transient” CPV: Baryogenesis & No EDM constraints
- ▷ “Transient” CPV requires light (~ 100 GeV) pseudoscalar & coupled to 125 GeV Higgs boson (& rest of Higgs sector)...

Within LHC reach!

Cascade scalar decays @LHC

$$H_0 \rightarrow a_1 a_1 \rightarrow \bar{b} b \bar{b} b$$

$$H_0 \rightarrow Z a_1 \rightarrow \ell \bar{\ell} b \bar{b}$$

...

Thank you!





KEEP
CALM
AND
BACKUP
YOUR
WORK

2HDM + a

(Two Higgs doublets + singlet pseudoscalar) $V = V_{2\text{HDM}} + V_a$

$$V_a = \frac{\mu_a^2}{2} a^2 + \frac{\lambda_a}{4} a^4 + \left(i \kappa a H_1^\dagger H_2 + \text{h.c.} \right) + \lambda_{aH_1} a^2 |H_1|^2 + \lambda_{aH_2} a^2 |H_2|^2$$

$$V_{2\text{HDM}} = \mu_1^2 |H_1|^2 + \mu_2^2 |H_2|^2 - \left[\mu_{12}^2 H_1^\dagger H_2 + \text{h.c.} \right] + \frac{\lambda_1}{2} |H_1|^4 + \frac{\lambda_2}{2} |H_2|^4 + \lambda_3 |H_1|^2 |H_2|^2 + \lambda_4 |H_1^\dagger H_2|^2 + \frac{1}{2} \left[\lambda_5 (H_1^\dagger H_2)^2 + \text{h.c.} \right]$$

$$\dots + m_\chi \bar{\chi} \chi + g_\chi a \bar{\chi} i \gamma^5 \chi$$

Pseudoscalar portal to DM

Ipek, McKeen, Nelson, PRD 90 (2014), 055021

JMN, PRD 93 (2016), 031701

Goncalves, Machado, JMN, PRD 95 (2017), 055027

Bauer, Haisch, Kahlhoefer, JHEP 05 (2017), 138

Robens, Symmetry 12 (2021) 12, 2341



[LHC DM WG Benchmark]

Abe et al, Phys. Dark. Univ. 27 (2020), 100351

e.g.

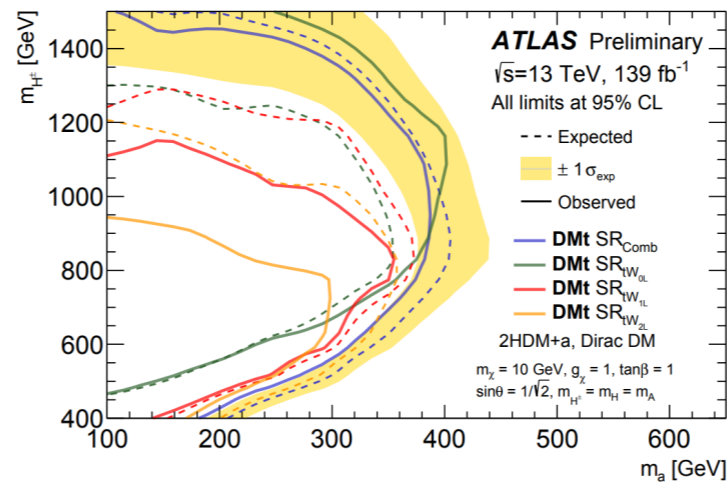
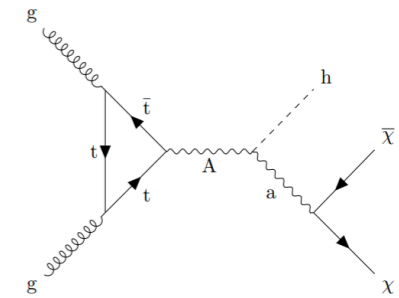
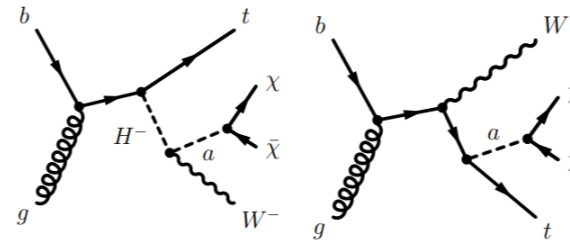

ATLAS-CONF-22-012

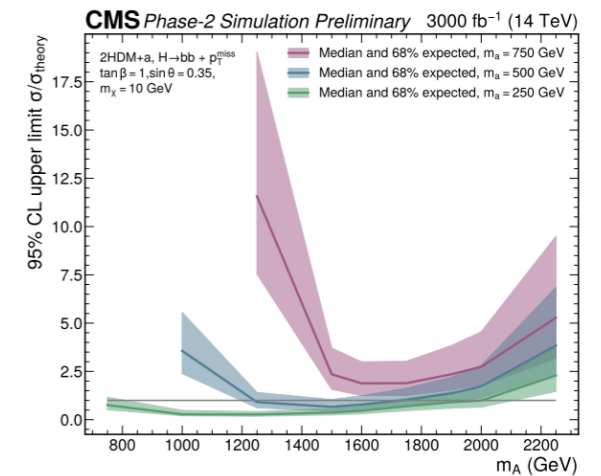

CMS-PAS-FTR-22-005

2HDM + a : Dark Matter?

$$\dots + m_\chi \bar{\chi}\chi + y_\chi a \bar{\chi}\gamma_5\chi$$

Very different LHC signatures!

Invisible decays of singlet-like pseudoscalar

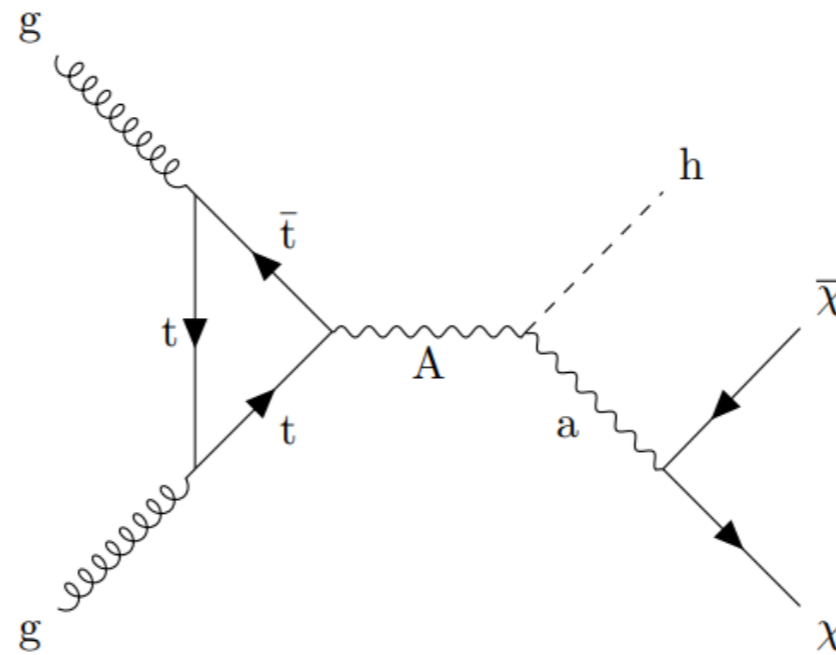

2HDM + a : Dark Matter?

$$\dots + m_\chi \bar{\chi}\chi + y_\chi a \bar{\chi}\gamma_5\chi$$

Recall:

$$T_S^2 = 12 |\mu_a^2| / (4 \lambda_{aH_1} + 4 \lambda_{aH_2} + 3 \lambda_a)$$

DM coupling yields

$$4 \lambda_{aH_1} + 4 \lambda_{aH_2} + 3 \lambda_a \rightarrow 4 \lambda_{aH_1} + 4 \lambda_{aH_2} + 3 \lambda_a + 2 y_\chi^2$$

Decrease in Singlet Temperature!

$$T_S > T_h ?$$

2HDM + a : Baryogenesis

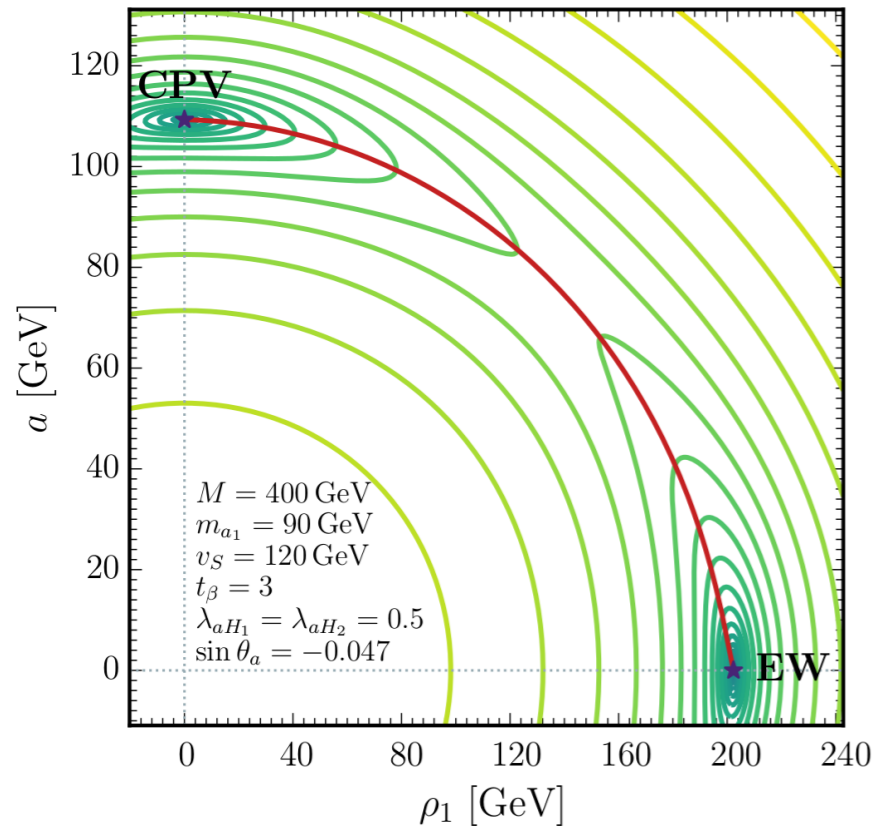

$$T = T_c$$

$(0, 0, v_S(T))$, $(v_1(T), v_2(T), 0)$
degenerate in energy

$$\xi_c = v_c / T_c$$

Transition strength

CP Violation & Baryogenesis

$$\mu_{12}^2(T) = \mu_{12}^2 - i \kappa v_S(T) \quad (\text{complex parameter in scalar potential})$$

Phase diff. between CPV and EW minima \longrightarrow

$$\delta_S = \text{Arg}[\mu_{12}^2(T)^* \mu_{12}^2]$$

$$\delta_t = \delta_S / (1 + t_\beta^2)$$

$$\frac{\eta}{10^{-11}} \sim 6 \times 10^2 \frac{\sin(\delta_t) \xi_c^2}{L_W T_c}$$

$$\eta_{\text{OBS}} = 8.7 \times 10^{-11}$$