

Newest results from the NEWS-G dark matter experiment

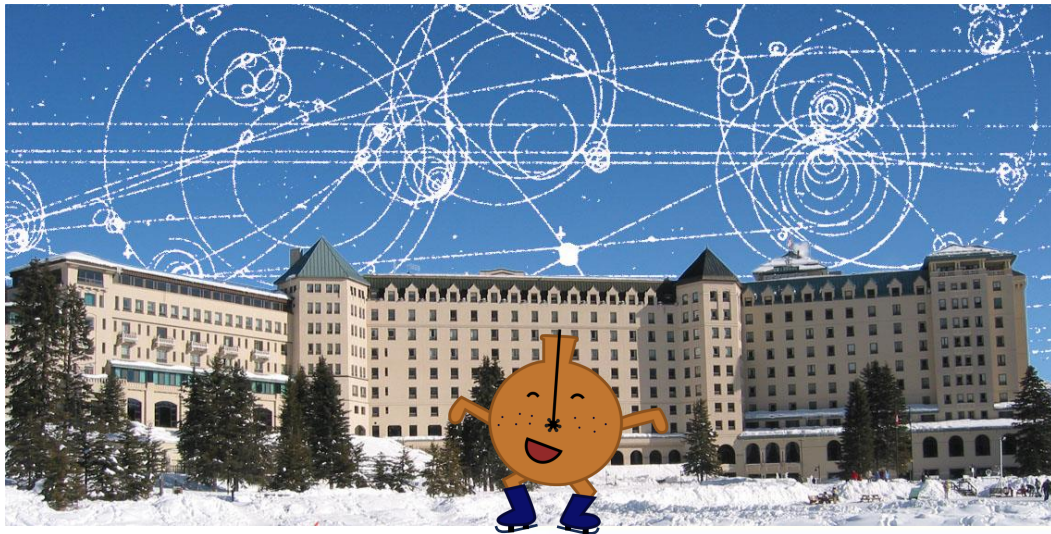

Philippe Gros

On behalf of the NEWS-G collaboration

Lake Louise Winter Institute 2024

- Given the absence of canonical WIMPs, there is motivation to look at the parameter space left at lower masses ($\sim 0.1-1$ GeV) for WIMP-like dark matter candidates.

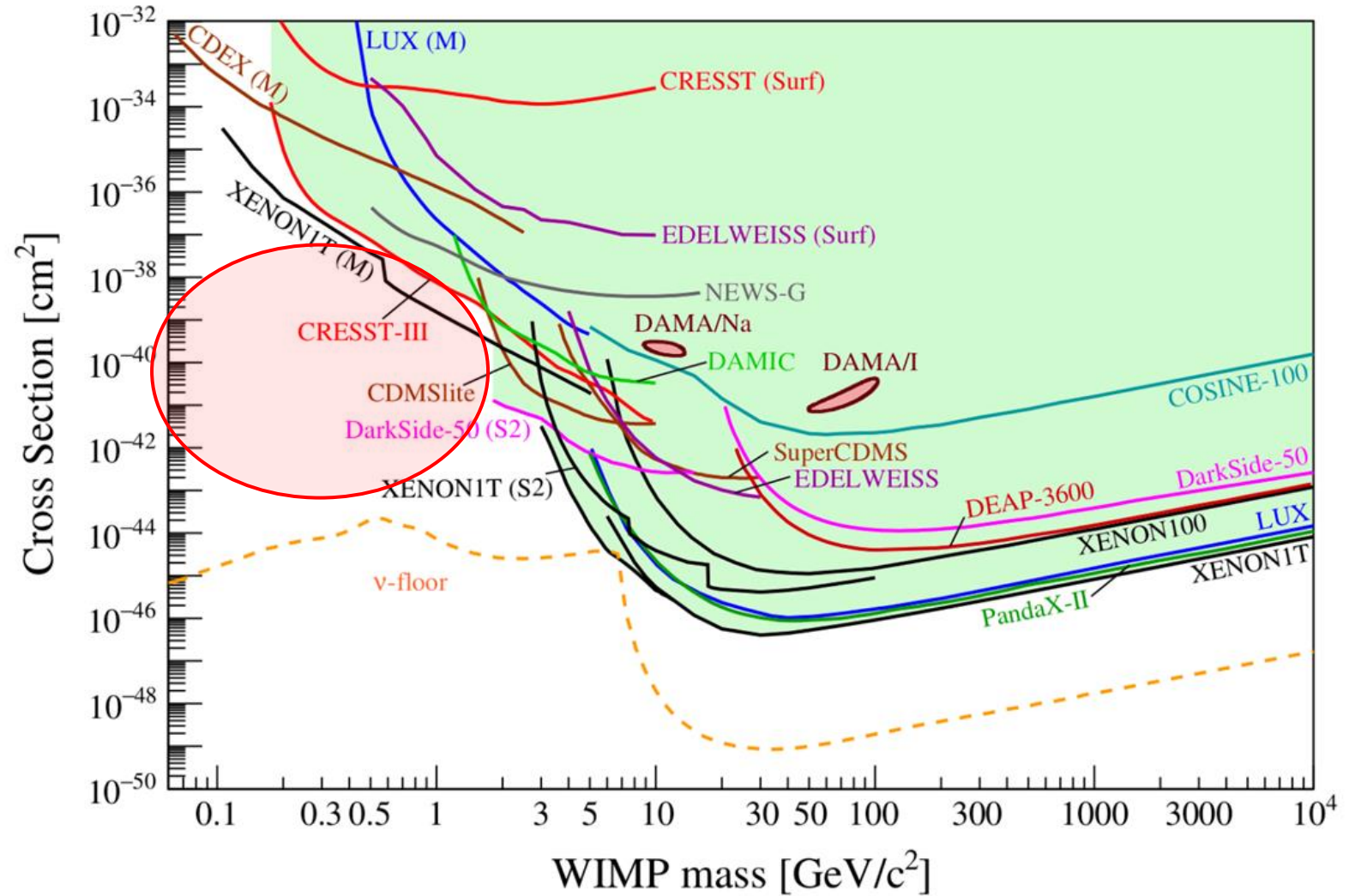

[arXiv:2104.07634](https://arxiv.org/abs/2104.07634) [hep-ex]

- The NEWS-G experiment uses spherical proportional counters (SPC) to search for low mass dark matter.
- SPCs are metallic spheres filled with gas, with a central anode producing a radial electric field.
- The [last dark matter limits](#) are from the SEDINE detector (60 cm diameter) at the *Laboratoire Souterrain de Modane* (LSM) in 2017.
- The latest detector, S140, is a 135 cm of diameter copper sphere currently at SNOLAB, after a short commissioning at the LSM in 2019.

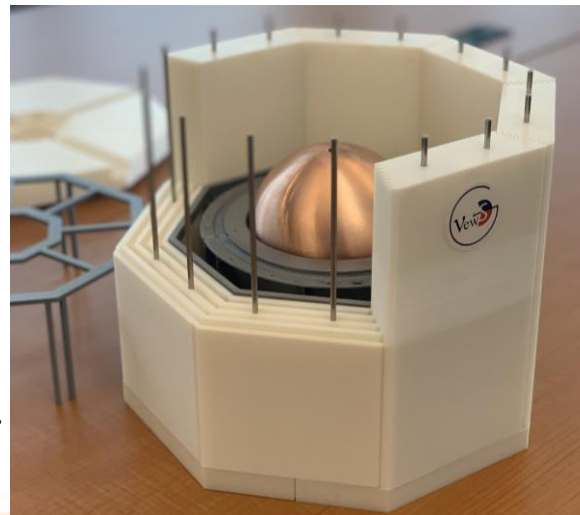

S-140 detector model



[doi: 10.1016/j.astropartphys.2017.10.009](https://doi.org/10.1016/j.astropartphys.2017.10.009)

1. Nuclear or electronic recoil causes ionization of the gas.
2. Primary electrons drift towards the central anode.
3. Townsend avalanche near the anode amplifies the signal.
4. Drifting secondary ions induce a current on the anode.

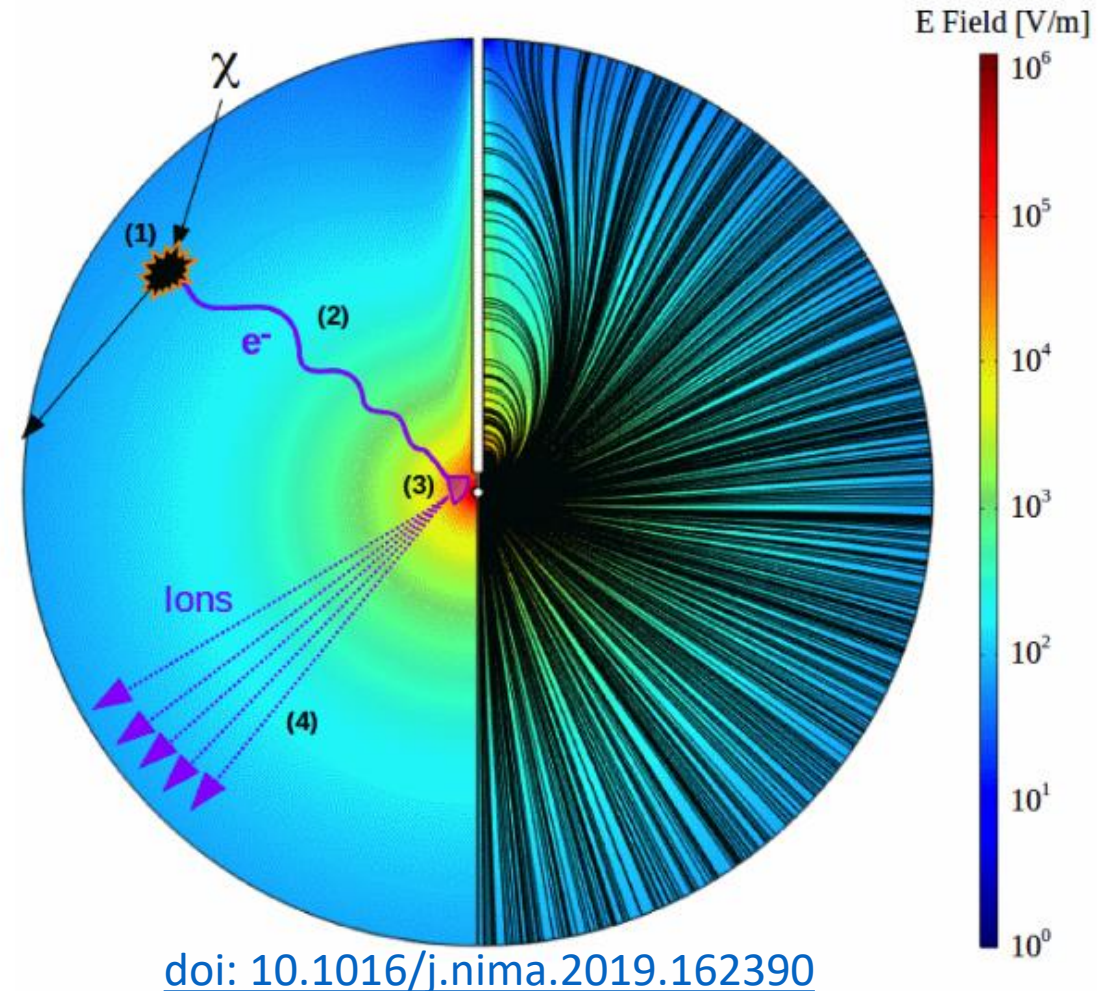

- NEWS-G now uses a multi-anode sensor that can achieve high gain while keeping a strong electric field at a high radius.
- The sensor is divided in two channels connecting the anodes of each hemisphere.
- A signal on one channel induces a negative signal on the other one (Shockley-Ramo effect).
- About 2/3 of the volume leads to the south anodes, due to the effect of the rod on the electric field.

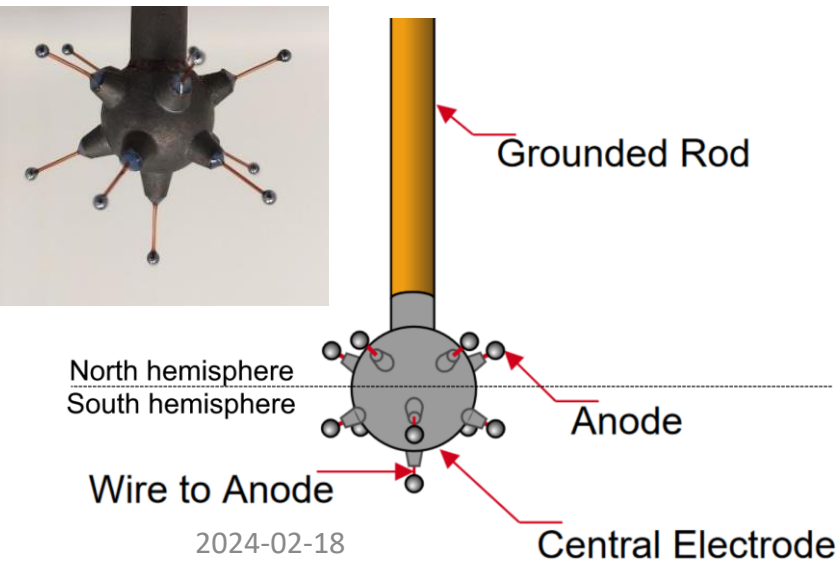

2024-02-18

[doi:10.1088/1742-6596/2156/1/012059](https://doi.org/10.1088/1742-6596/2156/1/012059)

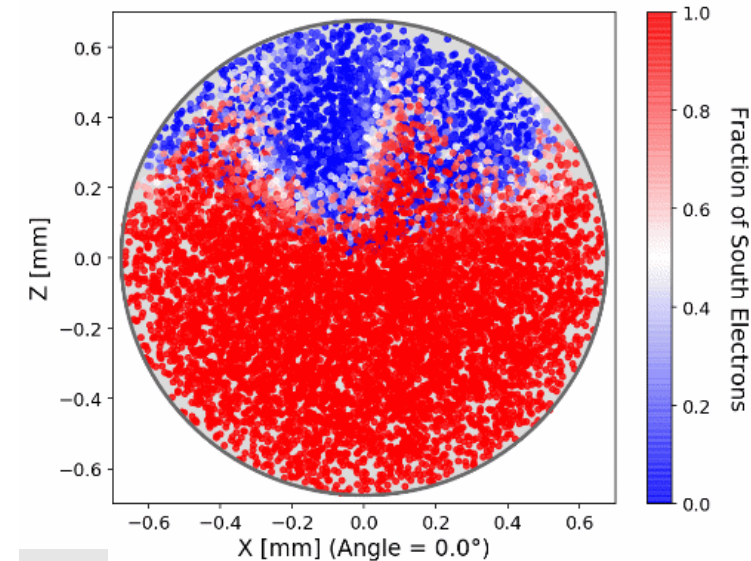
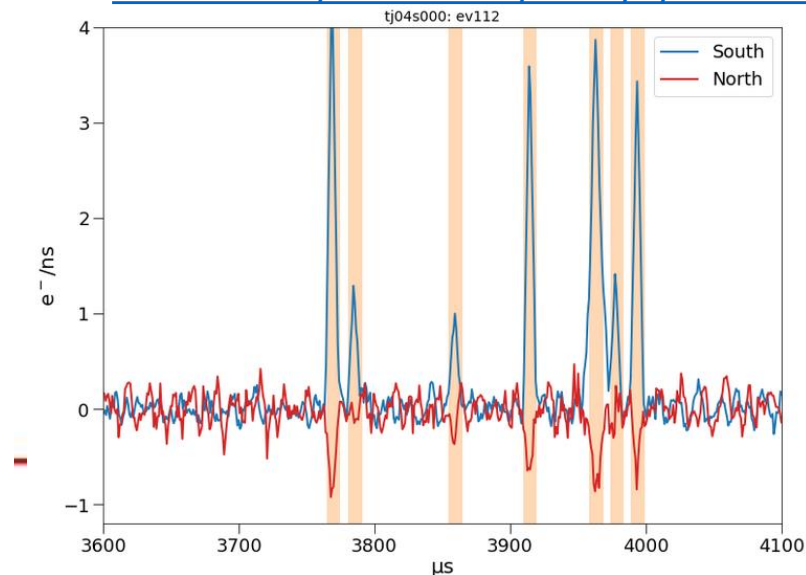

Only pure south events were kept as candidate events.



Shielding and data taking with S140

- The sphere is made of C10100 copper, with the inner 0.5 mm being electroformed ultra-pure copper.
- Lead, archeological lead and polyethylene (PE) make the shielding, although a temporary water shield was used at the LSM.
- 10 days of physics data taken in 135 mbar of CH₄ at the LSM before the detector was shipped to SNOLAB.

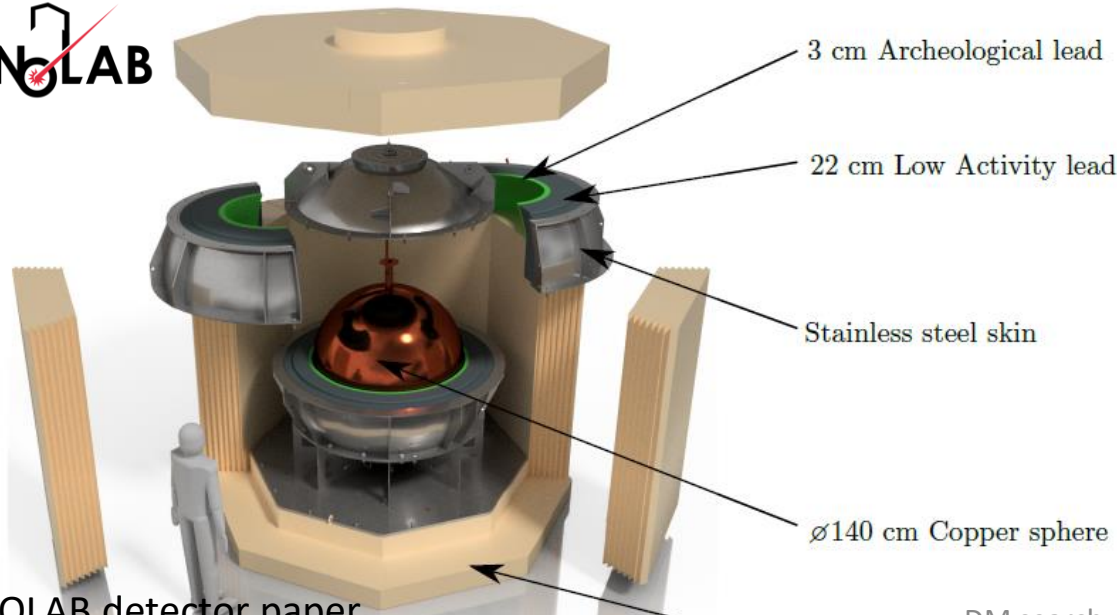

SNOLAB detector paper

2024-02-18
[doi:10.1088/1748-0221/18/02/T02005](https://doi.org/10.1088/1748-0221/18/02/T02005)

DM search with NEWS-G

Philippe Gros, Queen's U

Laboratoire Souterrain de Modane (LSM)



- A UV laser is directed at the inner copper surface of the sphere and releases electrons through the photoelectric effect. The UV light also goes to a photodetector so the laser events can be tagged as a control.

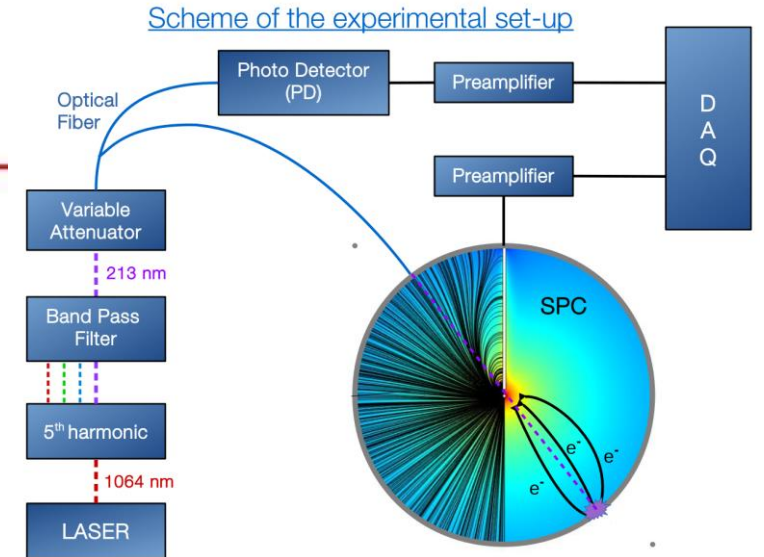

Calibration

- A UV laser is directed at the inner copper surface of the sphere and releases electrons through the photoelectric effect. The UV light also goes to a photodetector so the laser events can be tagged as a control.
- Some argon-37 is released inside the sphere, and the gas diffuses in the whole volume. This isotope is radioactive and has two peaks that enable energy calibration, as well as ionisation and attachment parametrization .

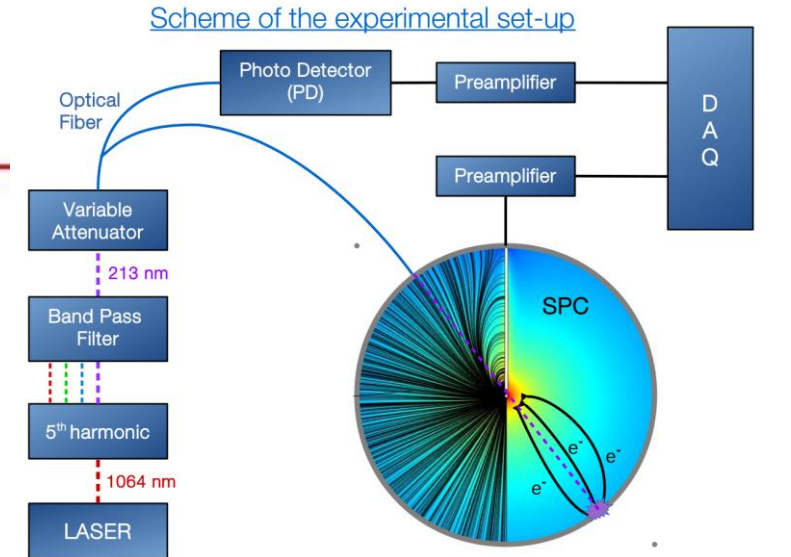

$$W_0 = 30.0^{+0.14}_{-0.15} \text{ eV}, \quad U = 15.70^{+0.52}_{-0.34} \text{ eV}, \quad F = 0.43 \pm 0.05$$

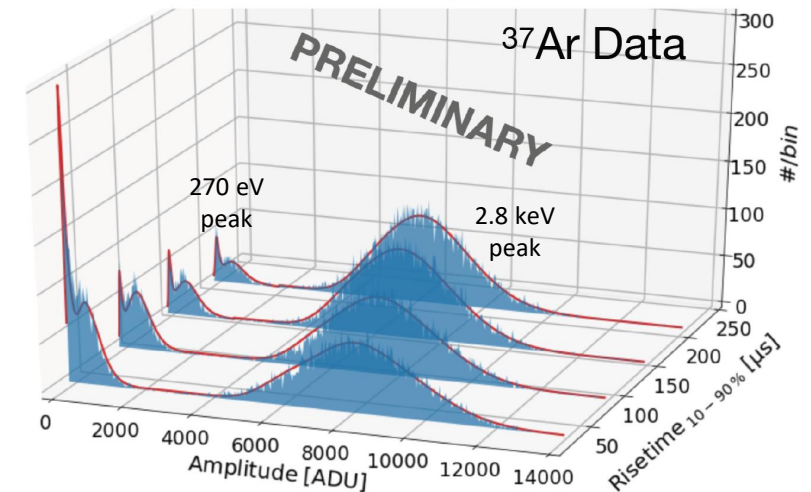

[doi:10.1088/1742-6596/2156/1/012059](https://doi.org/10.1088/1742-6596/2156/1/012059)

Calibration

- A UV laser is directed at the inner copper surface of the sphere and releases electrons through the photoelectric effect. The UV light also goes to a photodetector so the laser events can be tagged as a control.
- Some argon-37 is released inside the sphere, and the gas diffuses in the whole volume. This isotope is radioactive and has two peaks that enable energy calibration, as well as ionisation and attachment parametrization .
- The quenching factor was measured at COMIMAC as well as obtained from literature W-values.

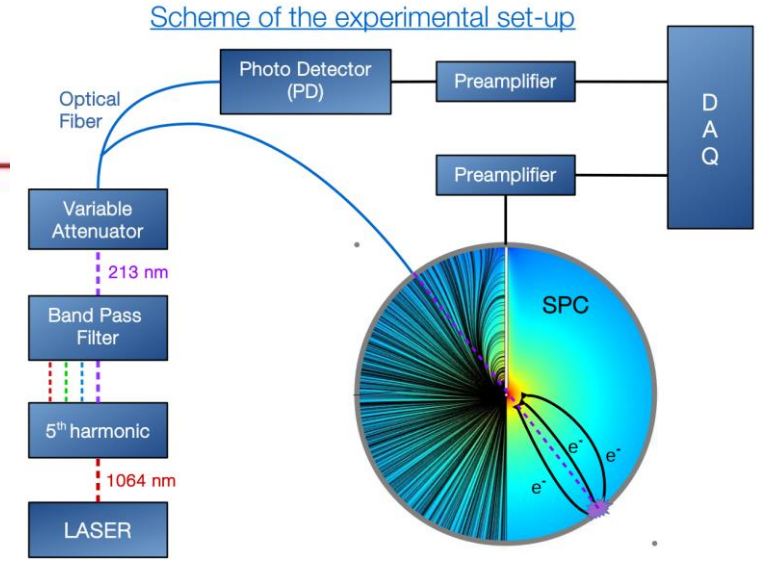

$$W_0 = 30.0^{+0.14}_{-0.15} \text{ eV}, \quad U = 15.70^{+0.52}_{-0.34} \text{ eV}, \quad F = 0.43 \pm 0.05$$

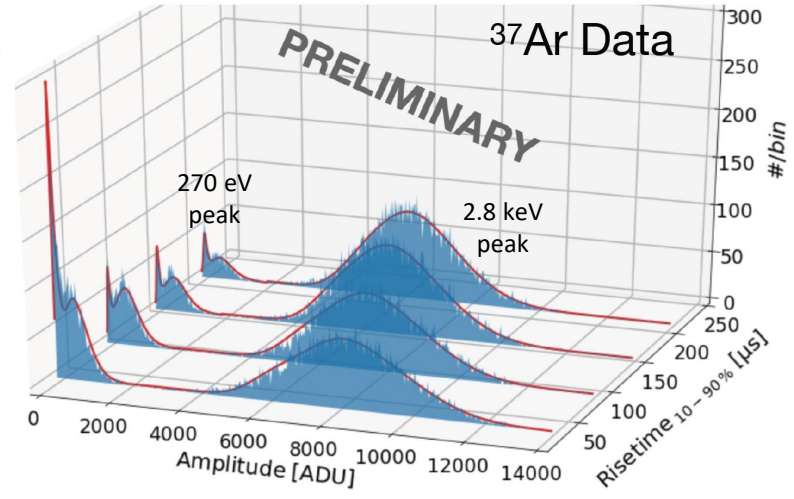
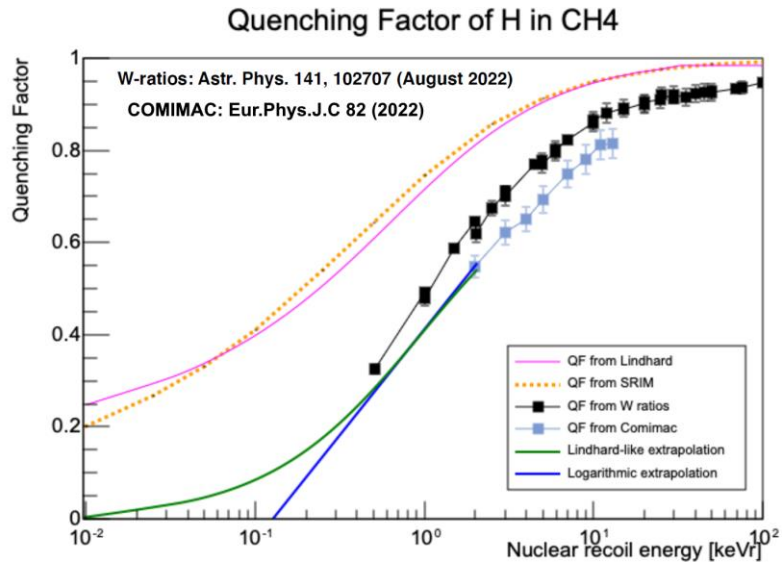
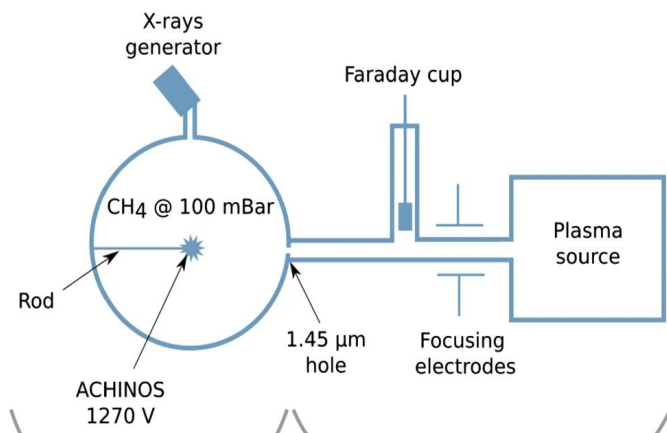

[doi:10.1088/1742-6596/2156/1/012059](https://doi.org/10.1088/1742-6596/2156/1/012059)



Peak counting and time separation

- The exponential decay of the preamplifier and the ion response signal.
- It is possible to count individual primary electrons.
- Surface events experience more diffusion than volume events, with τ between the first and last peak to be larger.

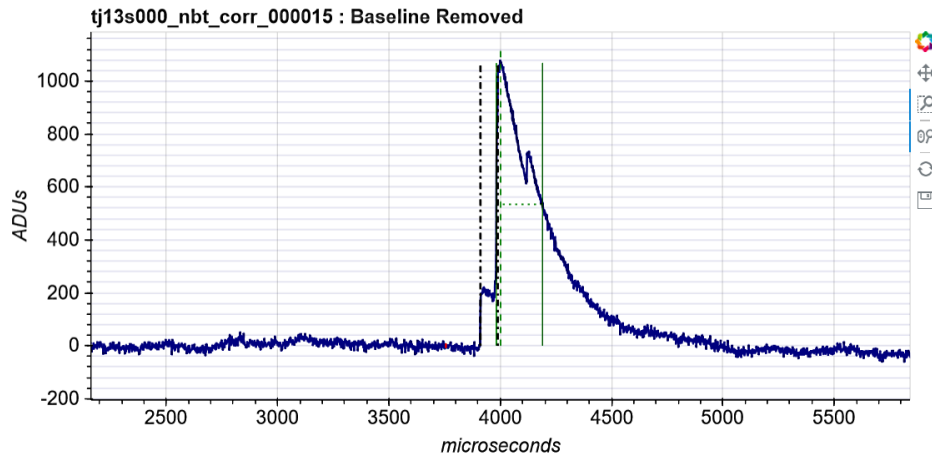
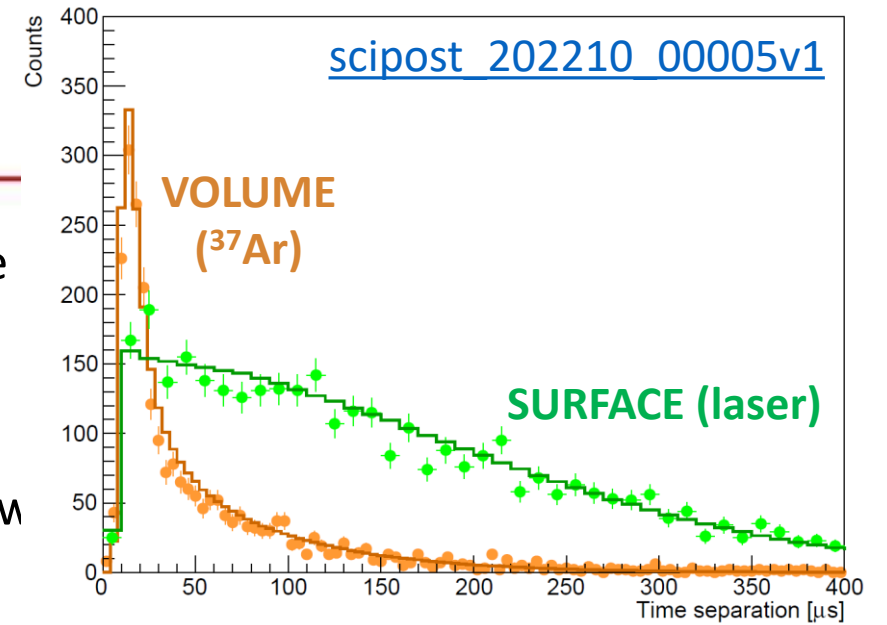

DOUBLE-
DECONVOLUTION

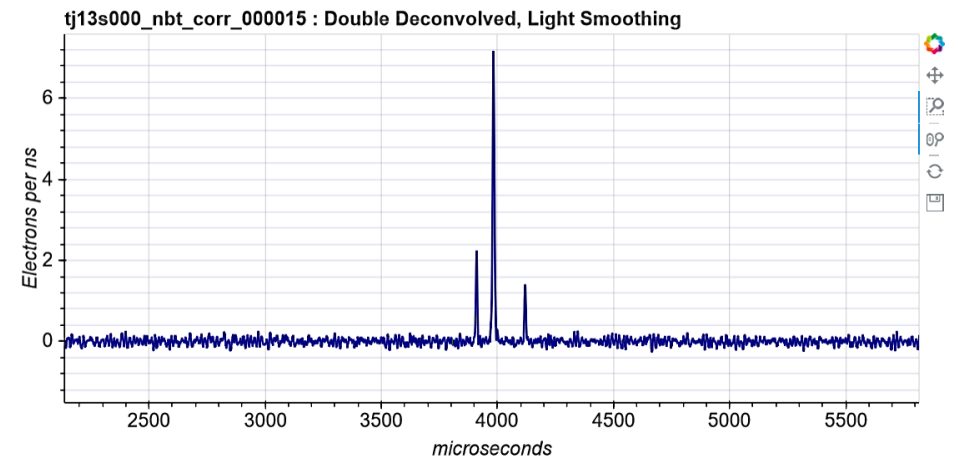

Alpha contamination

- There is ~ 25 mHz of alphas from ^{210}Po contamination in the copper surface.
- Alphas ionize a lot of gas and create a space charge that disturbs the electric field, and changes the electron drift time.
- A high rate of very low energy events keep happening for around 5s after each alpha. It is likely due to electronegative contaminants capturing electrons and becoming slow drifting ions
- We remove most of the low-energy background due to alphas with a 5s cut after each one, keeping 88% of the total time.

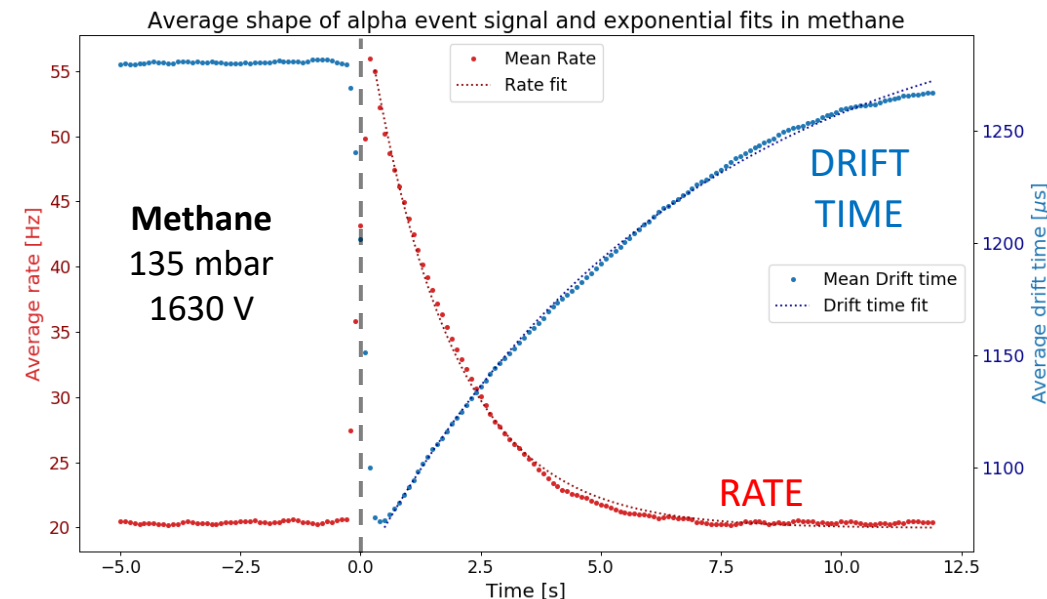
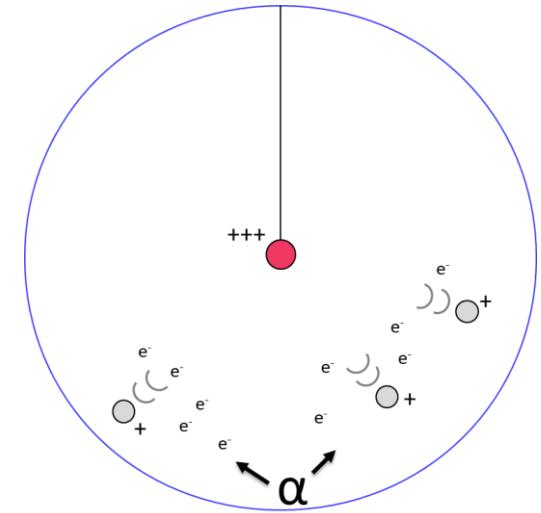

- 30% of the full data was set aside as a test data before the rest is unblinded.
- Profile likelihood fits of the test data were made for 2-3-4 peak data
- Fits with contributions from surface background, coincidences and WIMP signal.
- No significant WIMP signal was detected.
- WIMP exclusions limits with ~ 0.12 kg·days of data
- Strongest constraints for the proton spin-dependent interaction in the 0.2 - 1 GeV range.
- Data unblinded, final checks
- Final blind data results to come in a few weeks.

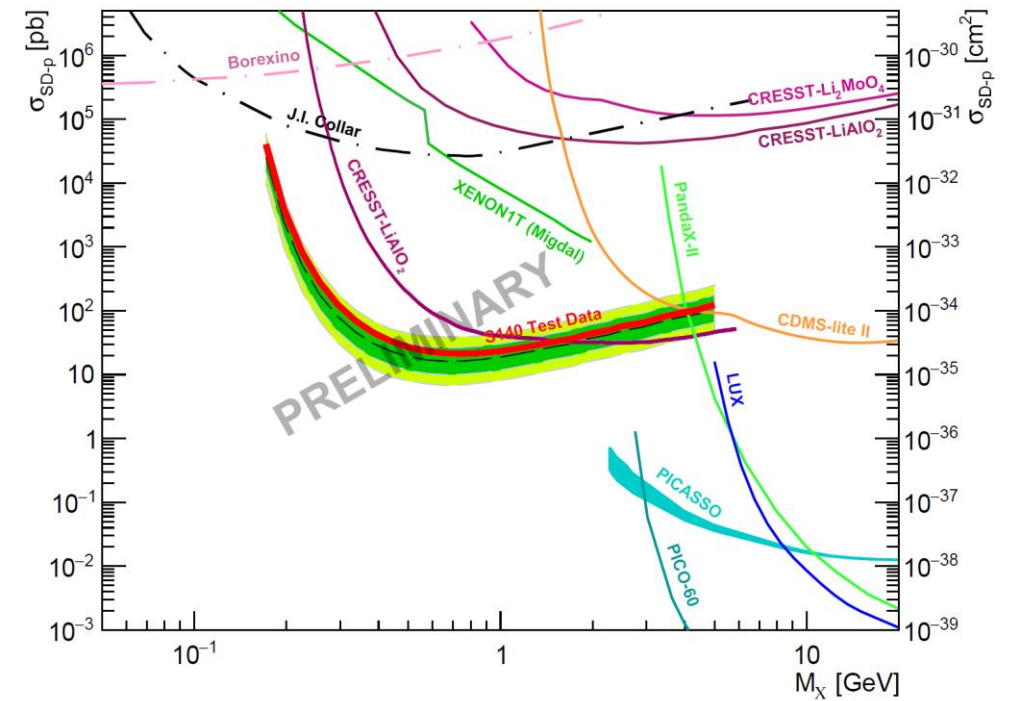

[scipost 202210 00005v1](https://arxiv.org/abs/2210.00005v1)



News from SNOLAB

- One physics data campaign taken, preparing the next one
- Still countable electrons
- Delays due to HV issues and alpha BG mitigation
- Improvements from LSM:
 - Trigger on three channels (North, South, laser)
 - Reduced noise
 - Better gas purity
 - Neon+2%CH₄, CH₄, Ar+CH₄, He+CH₄ etc.

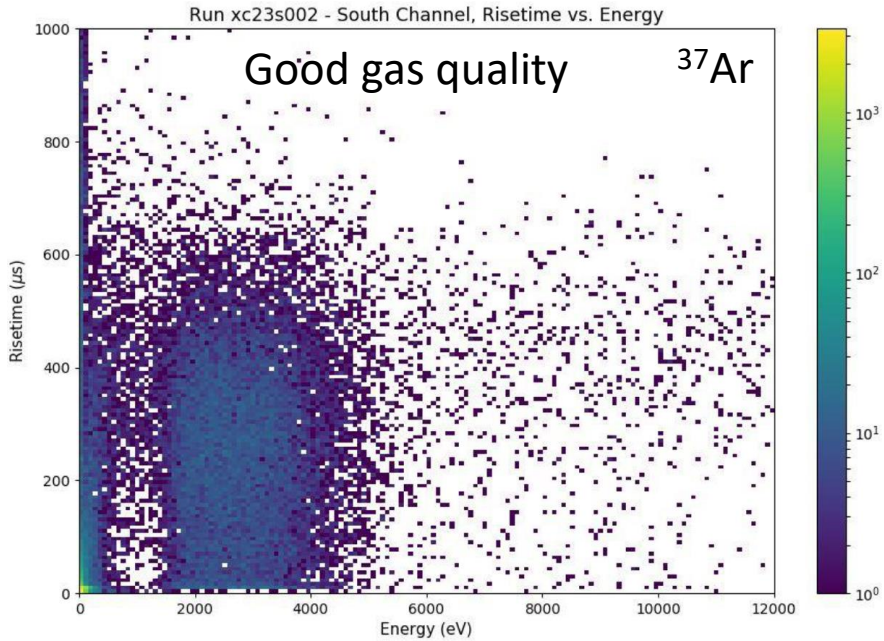
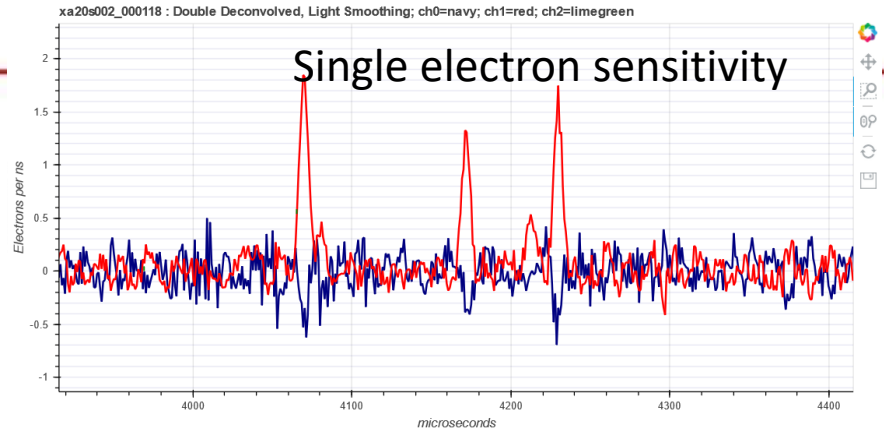

Evolution of the low frequency noise

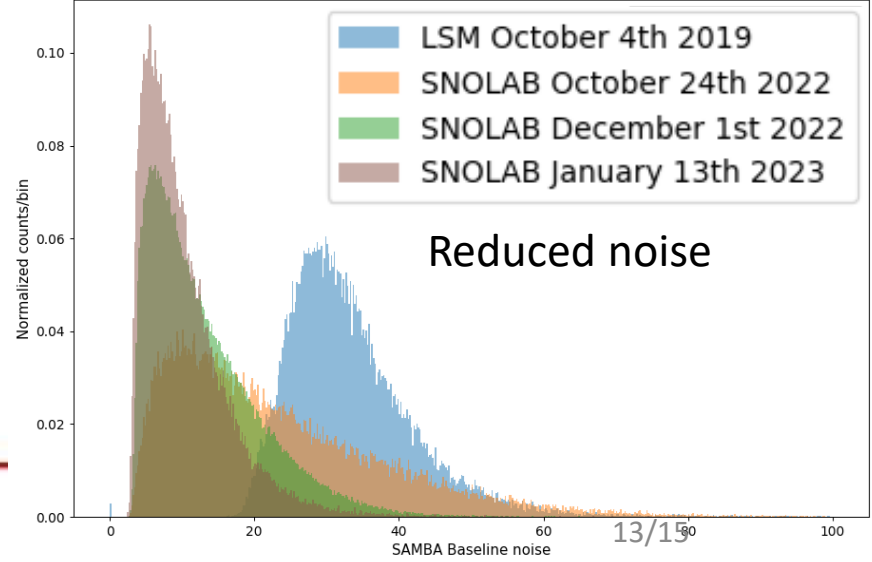

Future projects

- ECuME (& miniECuME):
 - Fully underground electroformed 140 cm of diameter copper sphere in SNOLAB.
(30 cm prototype to be built in 2024 at PNNL)
- DarkSPHERE:
 - Fully electroformed 3m of diameter sphere in a water shield in Boulby.
(under consideration)
- NEWS-G³ (or G3):
 - Shield at Queen's University intended for CEvNS detection at nuclear reactors.
(shield completed, ongoing testing and calibration)
- General sensor R&D
 - Smaller anodes for high pressure operation
 - New structures with 3D printed resistive material
 - Multi-channel acquisition

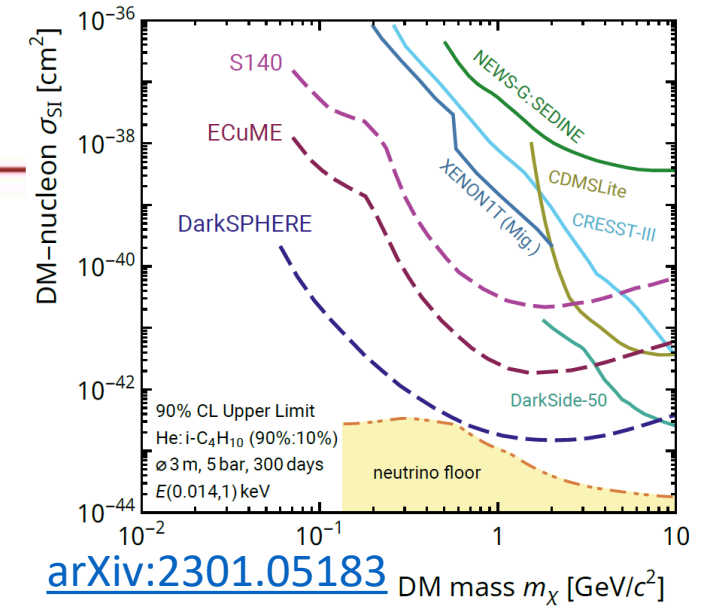

- NEWS-G and SPCs well suited for low mass dark matter search.
- 2019 data at LSM in pure methane will set new SD-p WIMP constraints with CH₄.
 - *Coming soon!*
- Currently taking physics data at SNOLAB with many improvements.
 - Data to be analysed. New target gases coming
- Promising future projects in the works.

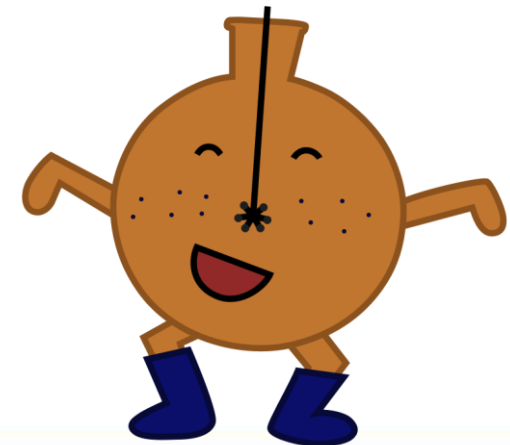



Thank you!

Thank you



Universität Hamburg



UNIVERSITY OF BIRMINGHAM



ARISTOTLE UNIVERSITY OF THESSALONIKI

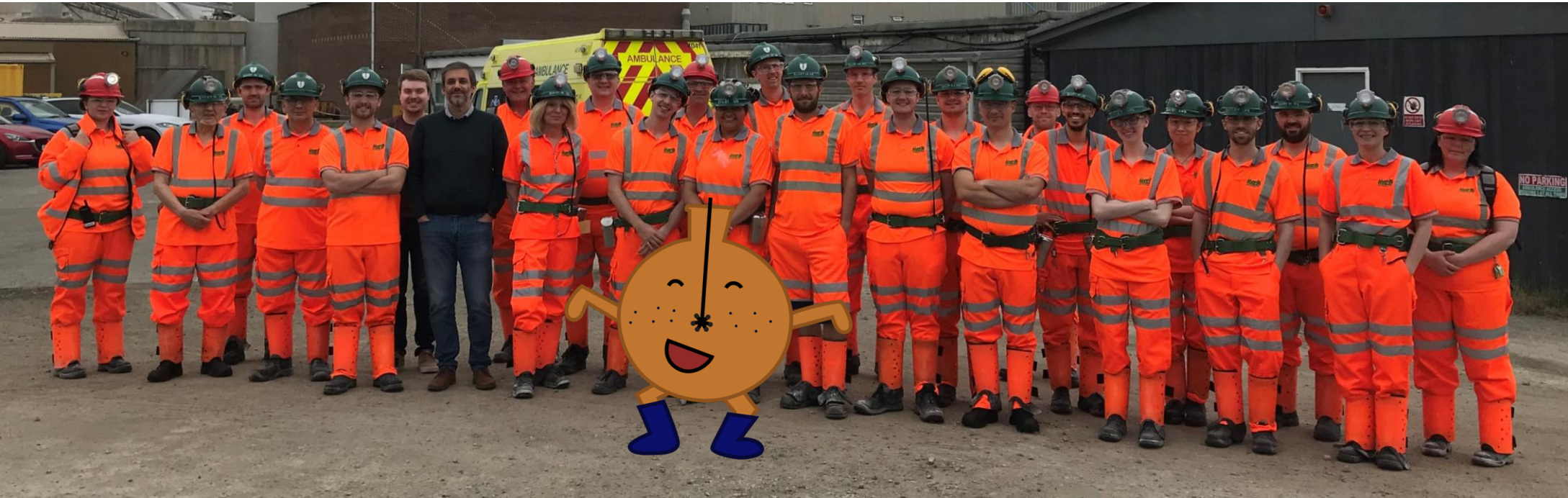

2024-02-18



DM search with NEWS-G
Philippe Gros, Queen's U





Extra slides



Pulse shape discrimination

- There are spurious pulses caused by electronic discharges in the data.
- Those can be discriminated from physical events with two different methods:
 - Spurious pulses are either measurably spikier or wider than physical events.
 - Spurious pulses do not cause a negative induced pulse on the opposite channel.
- Around 95% of the spurious pulses are removed with cuts using these discriminants, while still keeping 77% of the physical events.

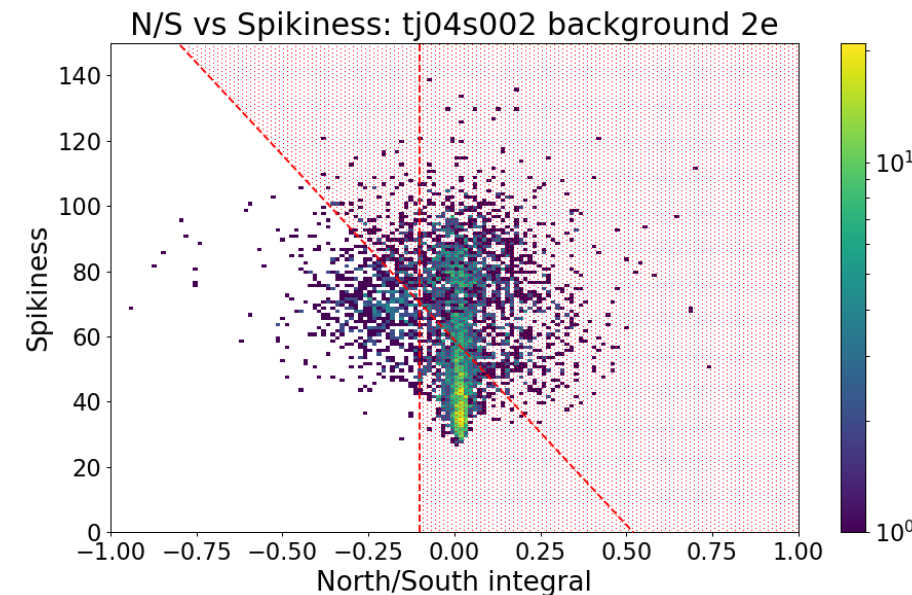
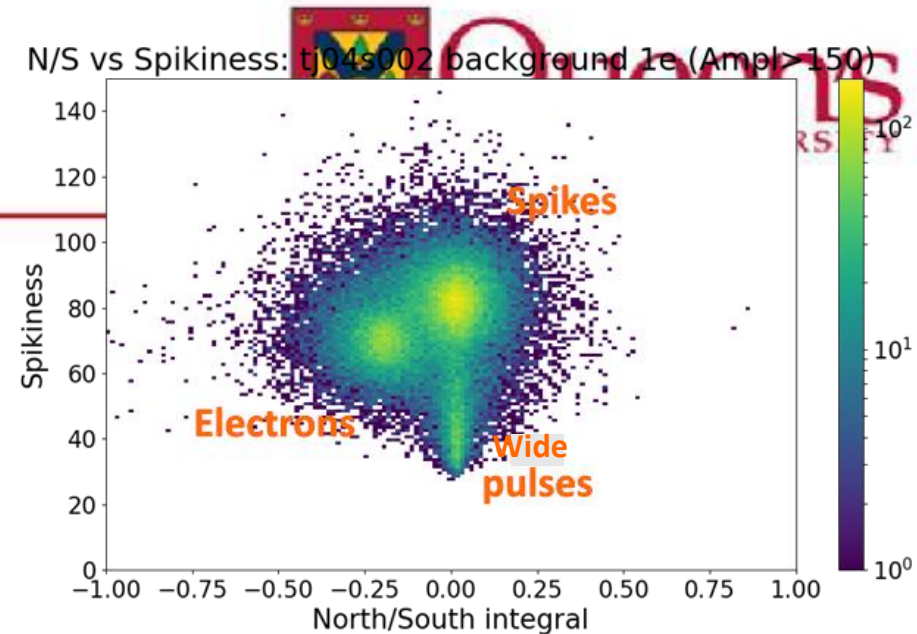

1. Nuclear or electronic recoil causes ionization of the gas.
2. Primary electrons drift towards the central anode.
3. Townsend avalanche near the anode amplifies the signal.
4. Drifting secondary ions induce a current on the anode.

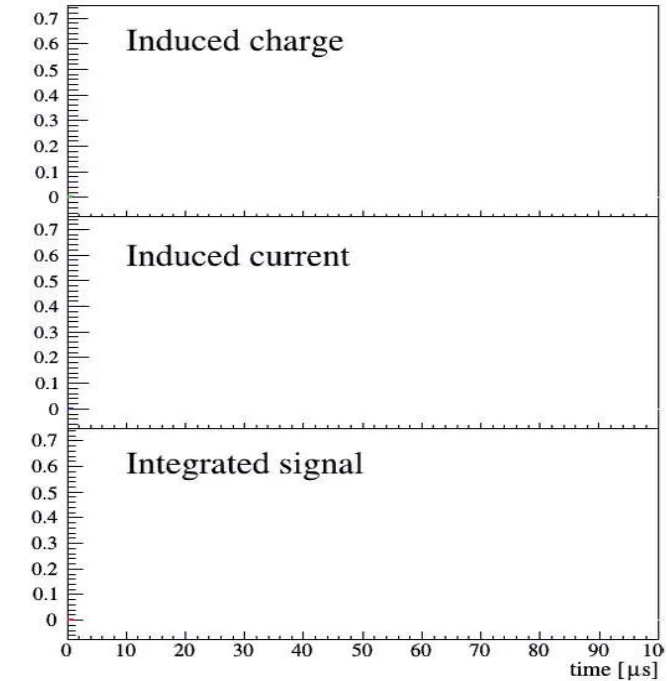
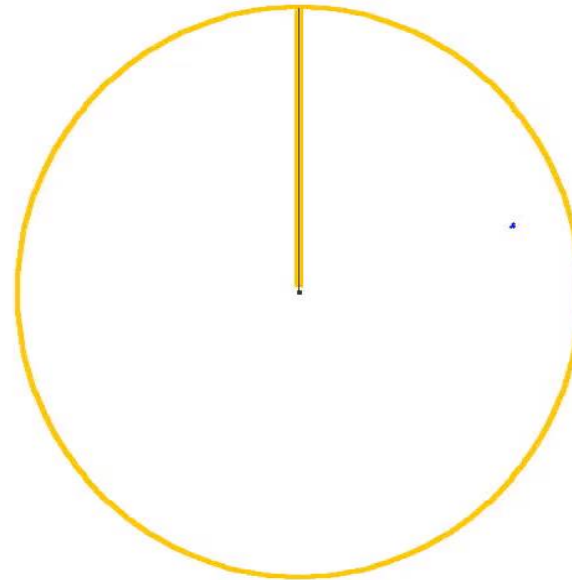

Animation by Philippe Gros

- Even the C10100 copper bulk contains traces of ^{210}Pb , which emits bremsstrahlung X-rays through their beta decay.
- The [electroforming of the 0.5mm inner copper surface](#) was done in collaboration with the Pacific Northwest National Lab at the LSM.
- This reduces the overall background by 98%, and the sub-keV background by 70%.

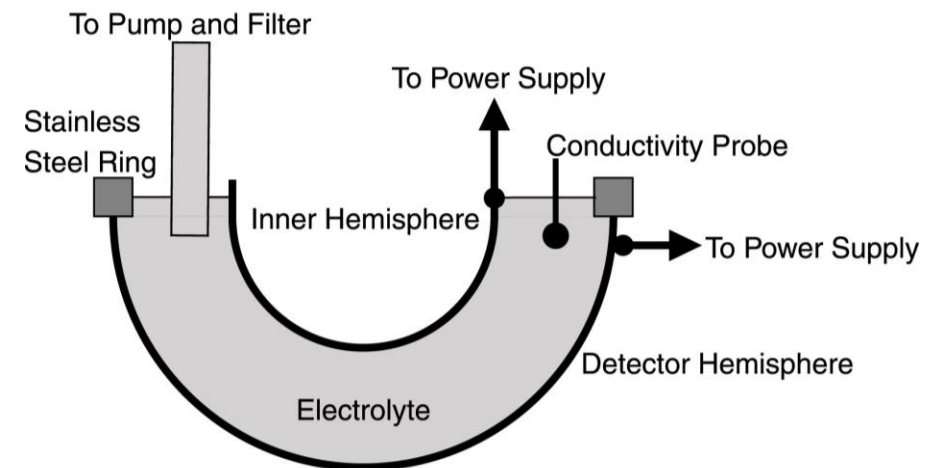
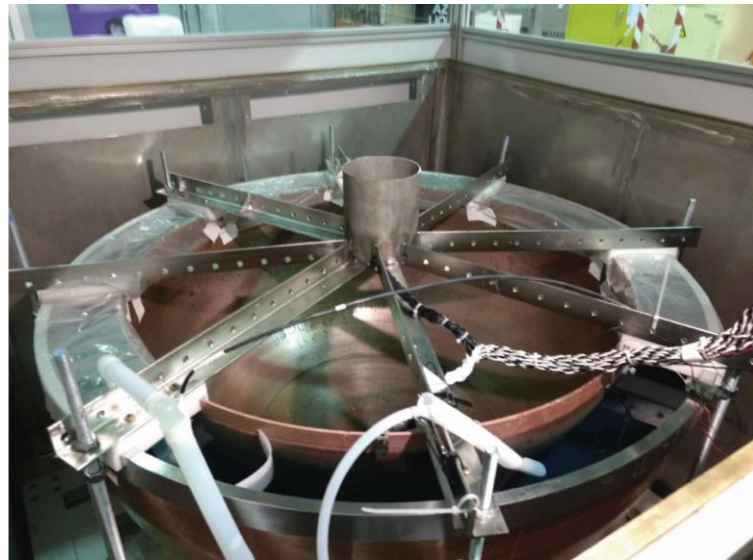

- Ionization equations: $\langle PE \rangle = \frac{E}{W(E)}$; $W_{nr} = \frac{W_\gamma}{QF(E)}$
- Primary ionization follows a COM-Poisson distribution, and the avalanche follows a Polya distribution.
- The exponential decay of the preamplifier and the ion response are deconvolved from the raw signal.

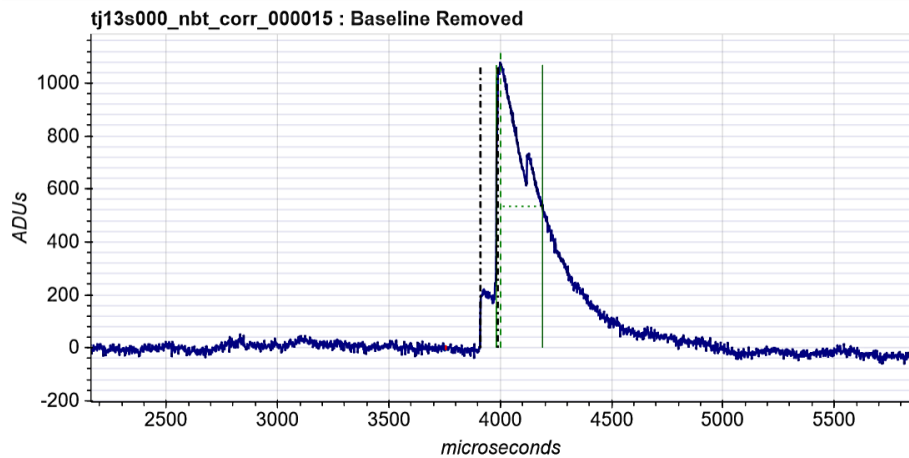

amplitude is proportional to the event energy
DOUBLE DECONVOLUTION



INTEGRATION

There is work on using machine learning as an alternative

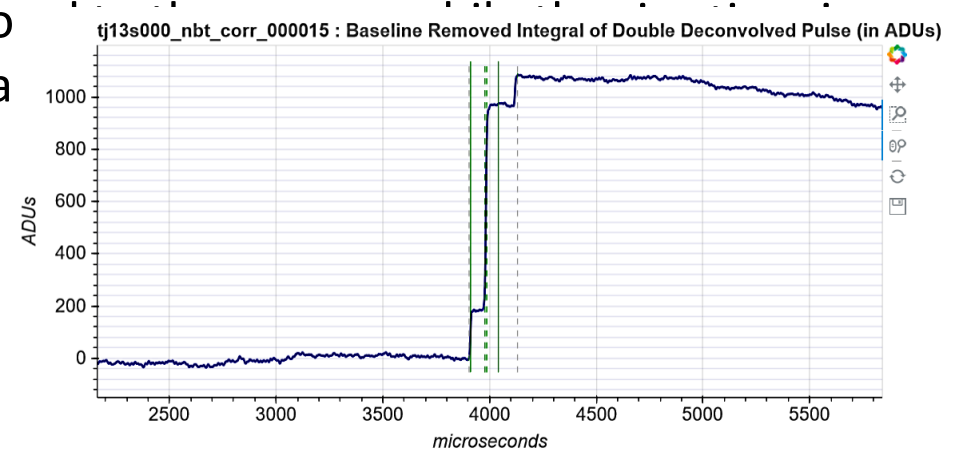

- With the large sphere of S140, it is possible to count individual primary electrons using ROOT TSpectrum.
- The single-electron trigger efficiency is 60%, with a noise trigger proportion around 10^{-4} .
- Surface events experience more diffusion than volume events, between the first and last peak to be larger.

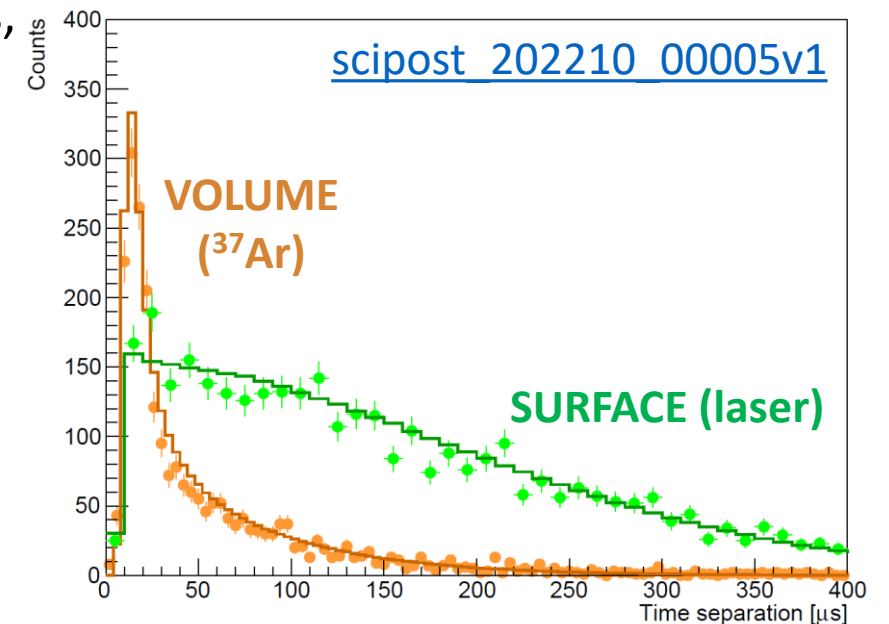
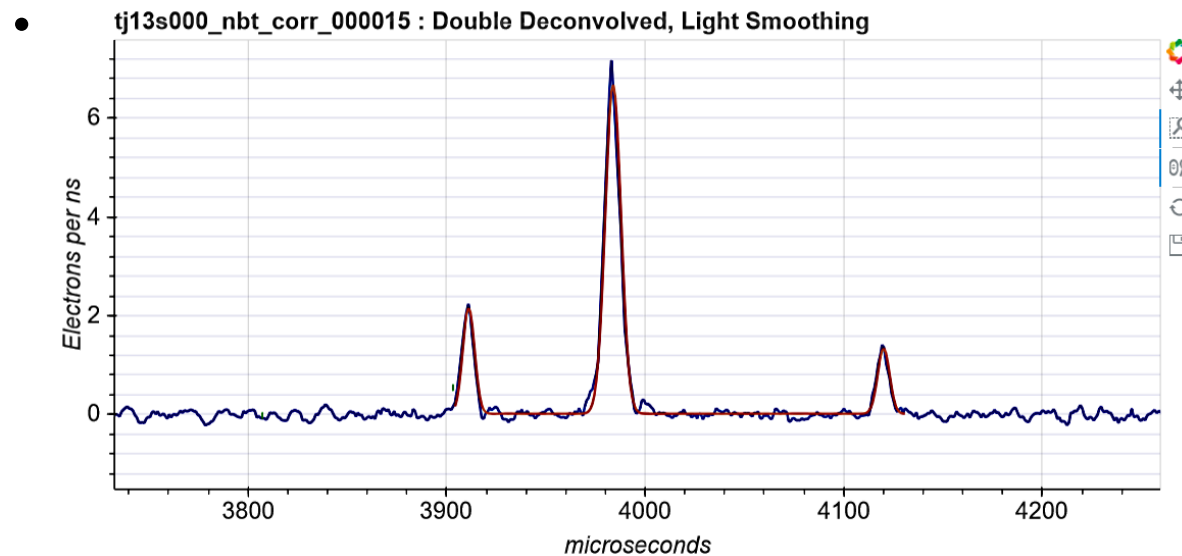

Laser calibration

- A 213nm UV laser is directed at the inner copper surface of the sphere and photoelectric effect.
- The UV light also goes to a photodetector so the laser events can be tagged
- Low-intensity laser data enables measurements of the single electron detection statistics, trigger efficiency, peak detection threshold).
- High intensity laser data is used in all runs to enable constant monitoring of the detector.
- Gas degradation inducing a decrease in gain can be seen through laser events.

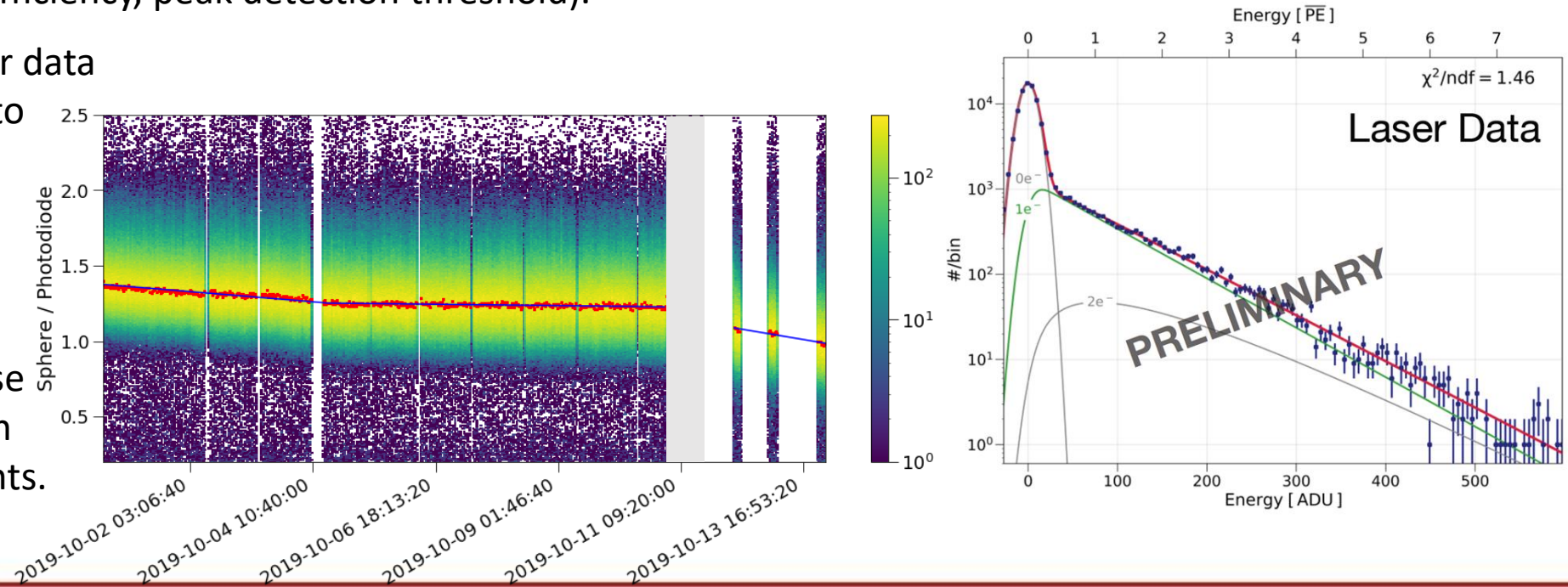
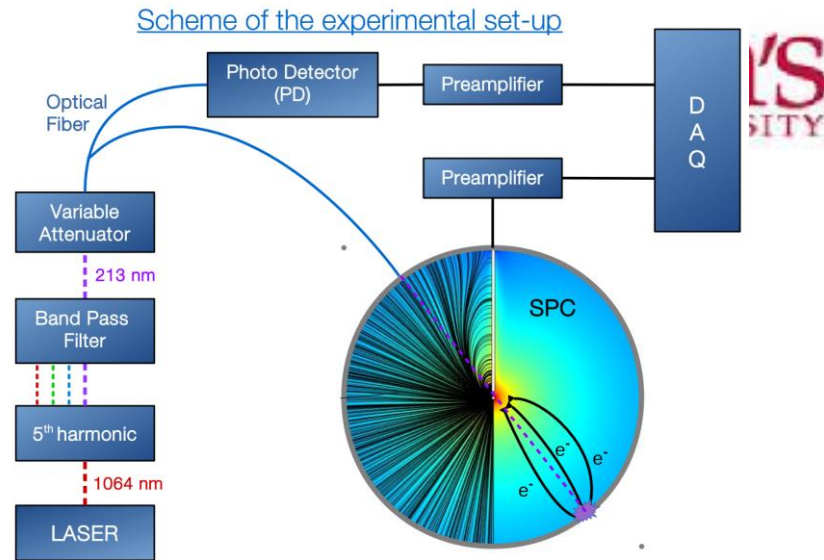

- Some argon-37 is released inside the sphere, and the gas diffuses in the whole volume. [\$^{37}\text{Ar}\$ is produced at the Royal Military College in Kingston](#), in their SLOWPOKE-II reactor from CaO irradiation.
- This isotope is radioactive and has two main X-ray peaks (270 eV and 2.8 keV). It decays with a half-life of 35 days through electron capture.
- Argon-37 enables:

- Energy calibration
- Electron attachment parametrization
- W-value and Fano factor measurements
- South-channel anodes gain measurements

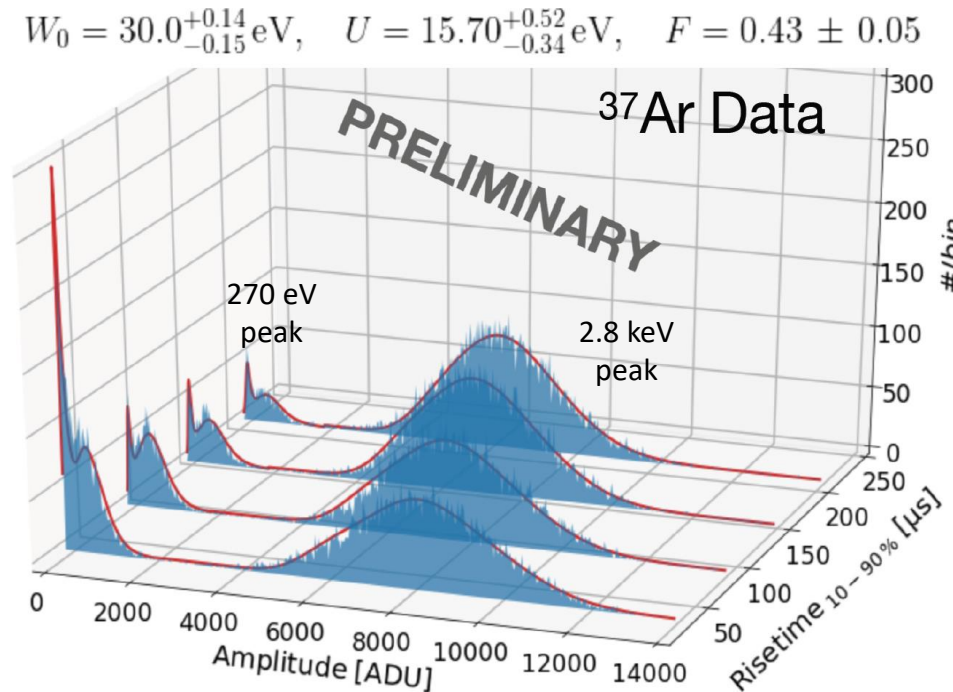

[doi:10.1088/1742-6596/2156/1/012059](https://doi.org/10.1088/1742-6596/2156/1/012059)

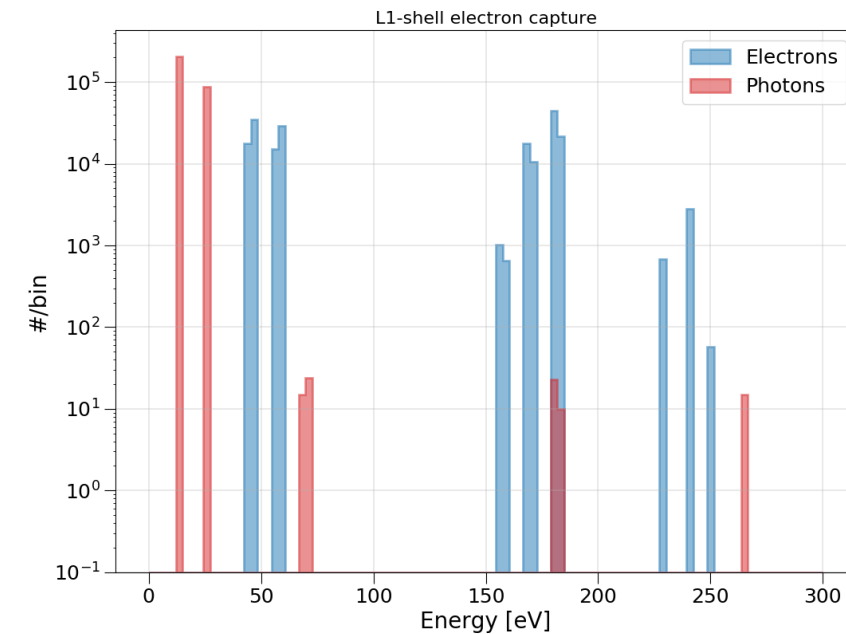

- The quenching factor was [measured at COMIMAC](#) as well as [obtained from literature W-values](#).
- Lower energy quenching factor were extrapolated logarithmically (more conservative).
- Future quenching factor measurements for lower energies and other gas mixtures in preparation.

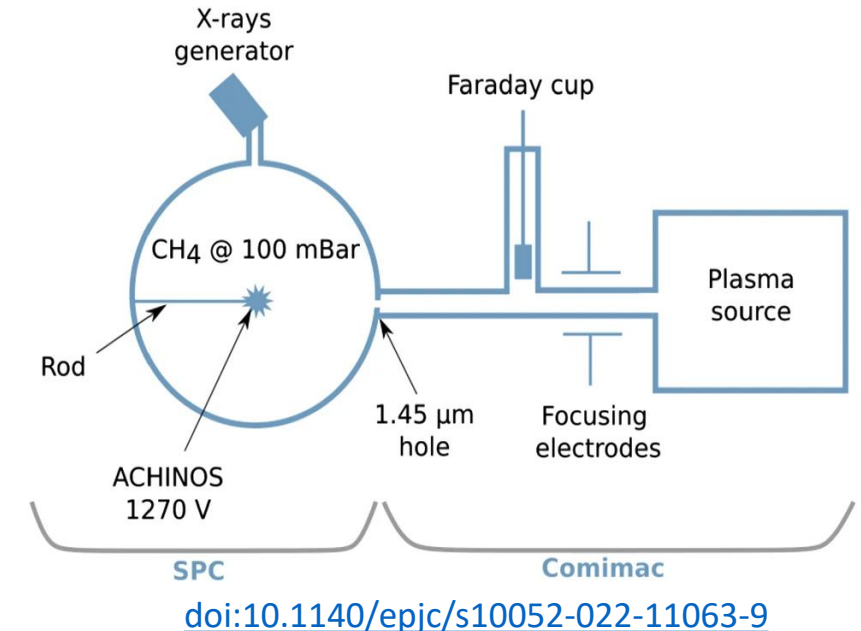
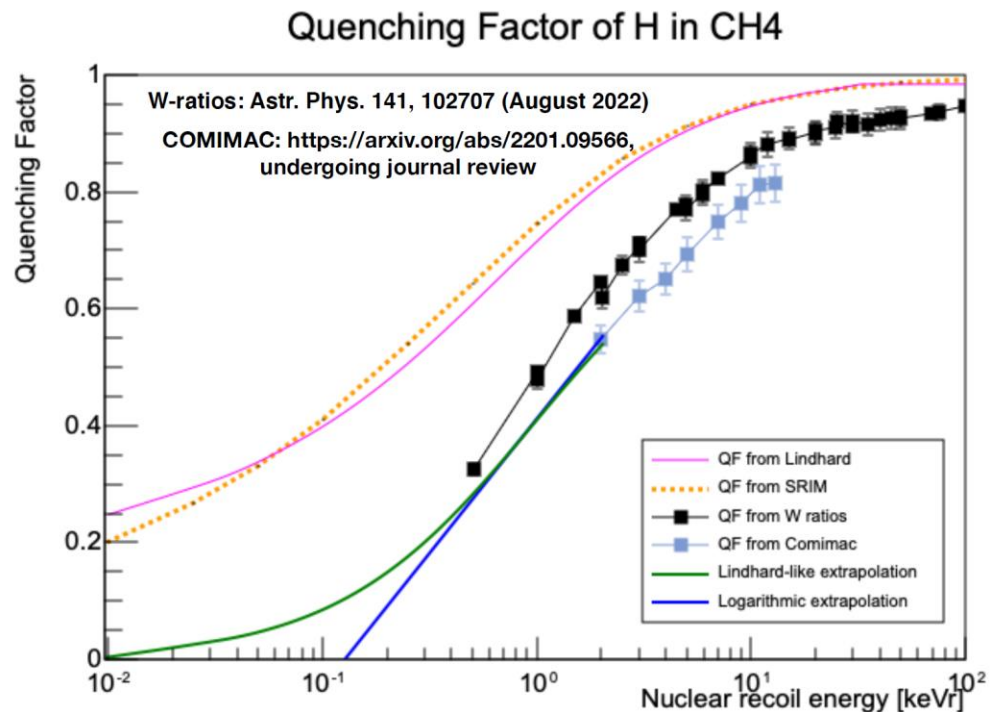

ECuME

- Fully underground electroformed 140 cm of diameter copper sphere shielded for the Boudry SNOLAB Underground Laboratory, in England (under consideration).
- Mini-ECuME prototype with 30 cm of diameter to be built during the second half of 2023 at PNNL.
- Last tests before Mini-ECuME currently being completed.

DarkSPHERE

- Fully electroformed 3m of diameter sphere in copper sphere shielded for the Boudry SNOLAB Underground Laboratory, in England (under consideration).

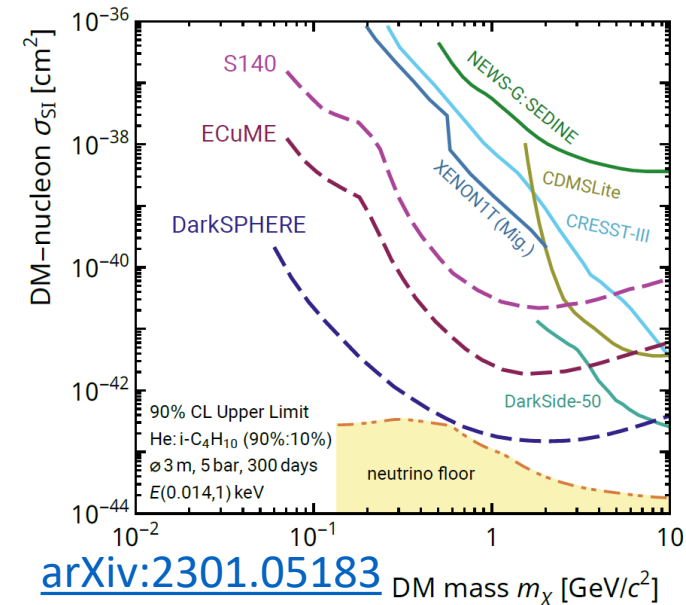

Neutrino research

NEWS-G³ (or G3)

- Shield at Queen's University intended for CEvNS detection at n
- The shield is comprised of multiple layers of lead, polyethylene copper. It was completed last summer.
- Tests, simulations and calibrations are currently being done at

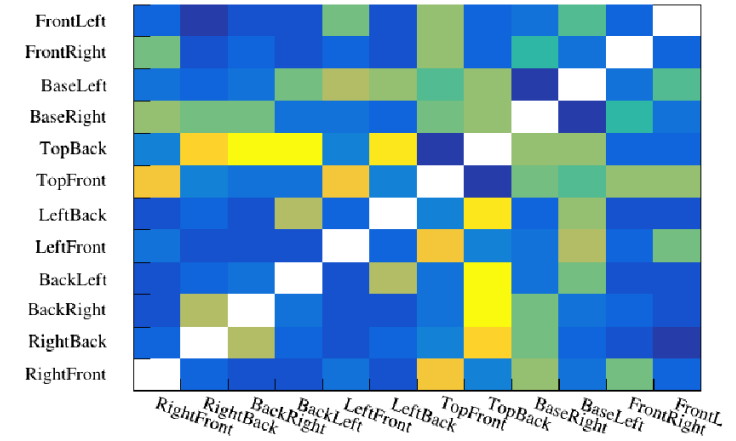
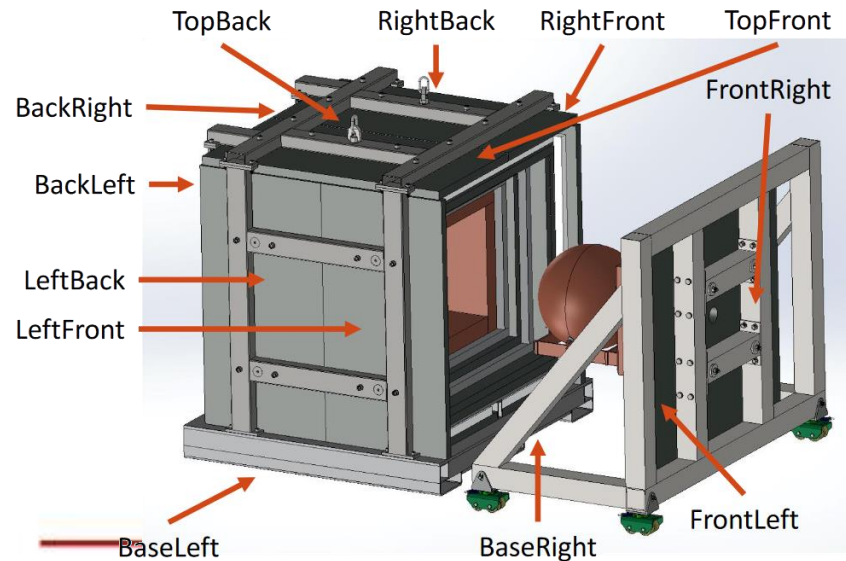



Double deconvolution

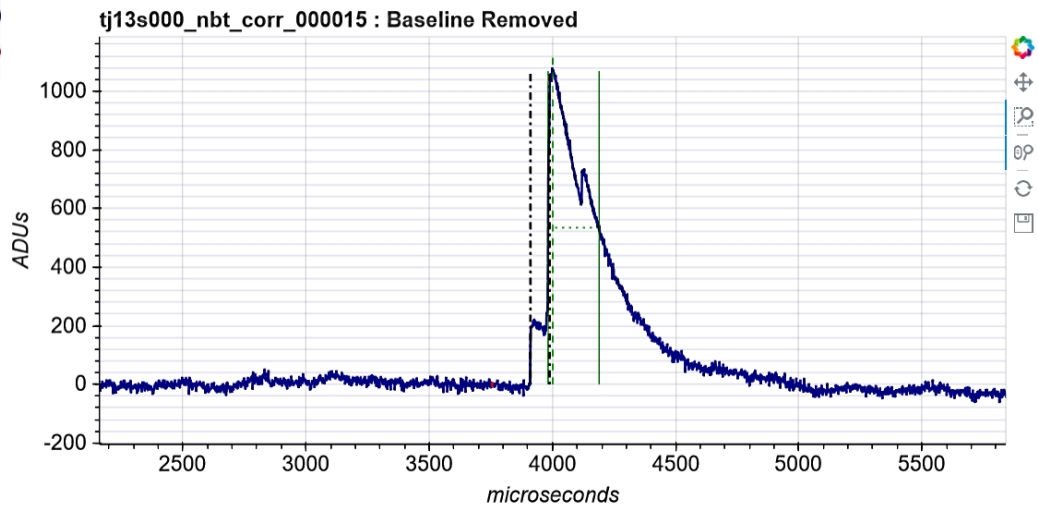

Double deconvolution

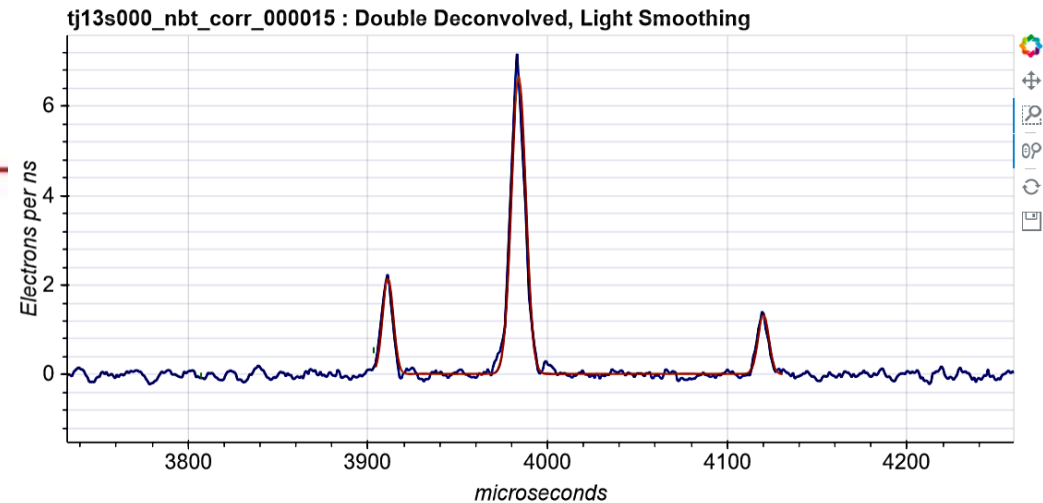

Integration

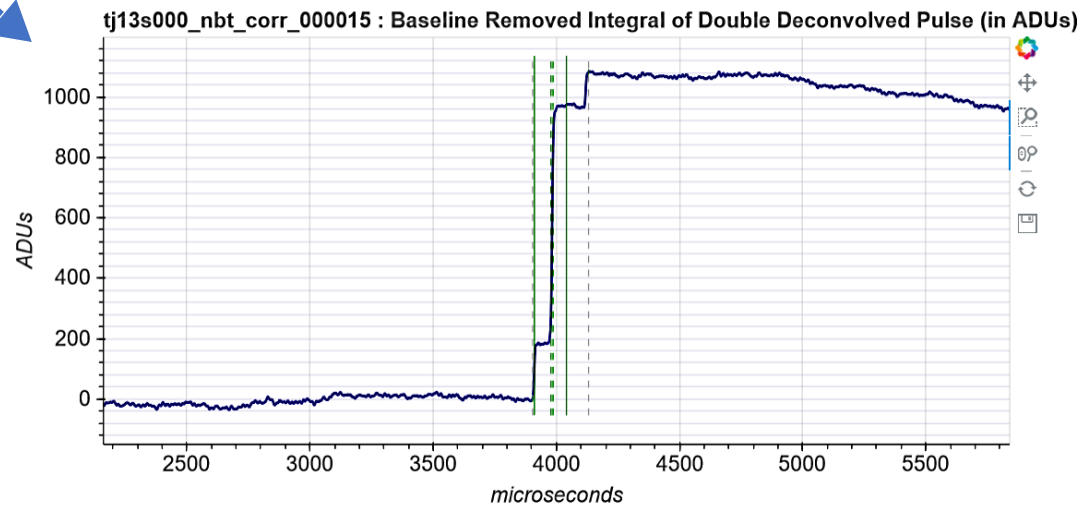

The ballistic deficit is the signal amplitude that gets underestimated due to the exponential decay of the preamplifier.

The full amplitude (energy) is retrieved by doing a double deconvolution of the raw signal, and then integrating the pulses.