

Puma

Survey of existing elements

31.10.2022

Antje Behrens

Wall cut-out

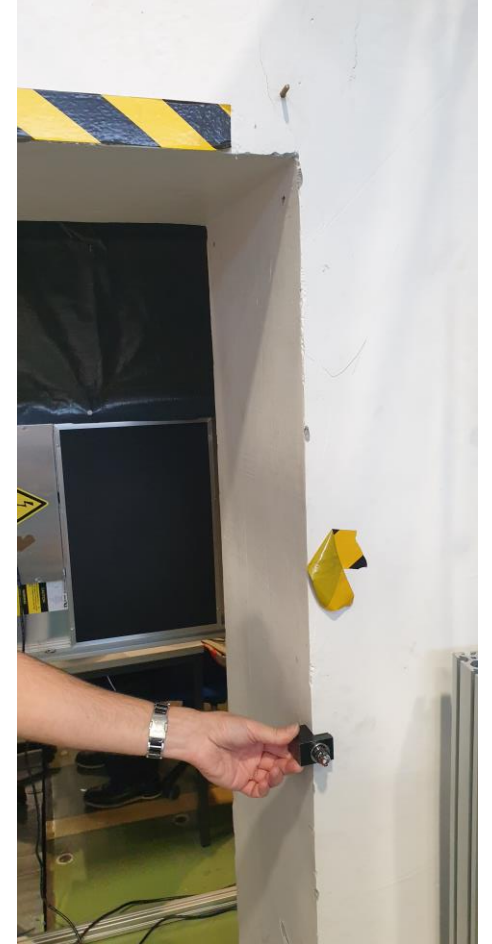

Crowded Area

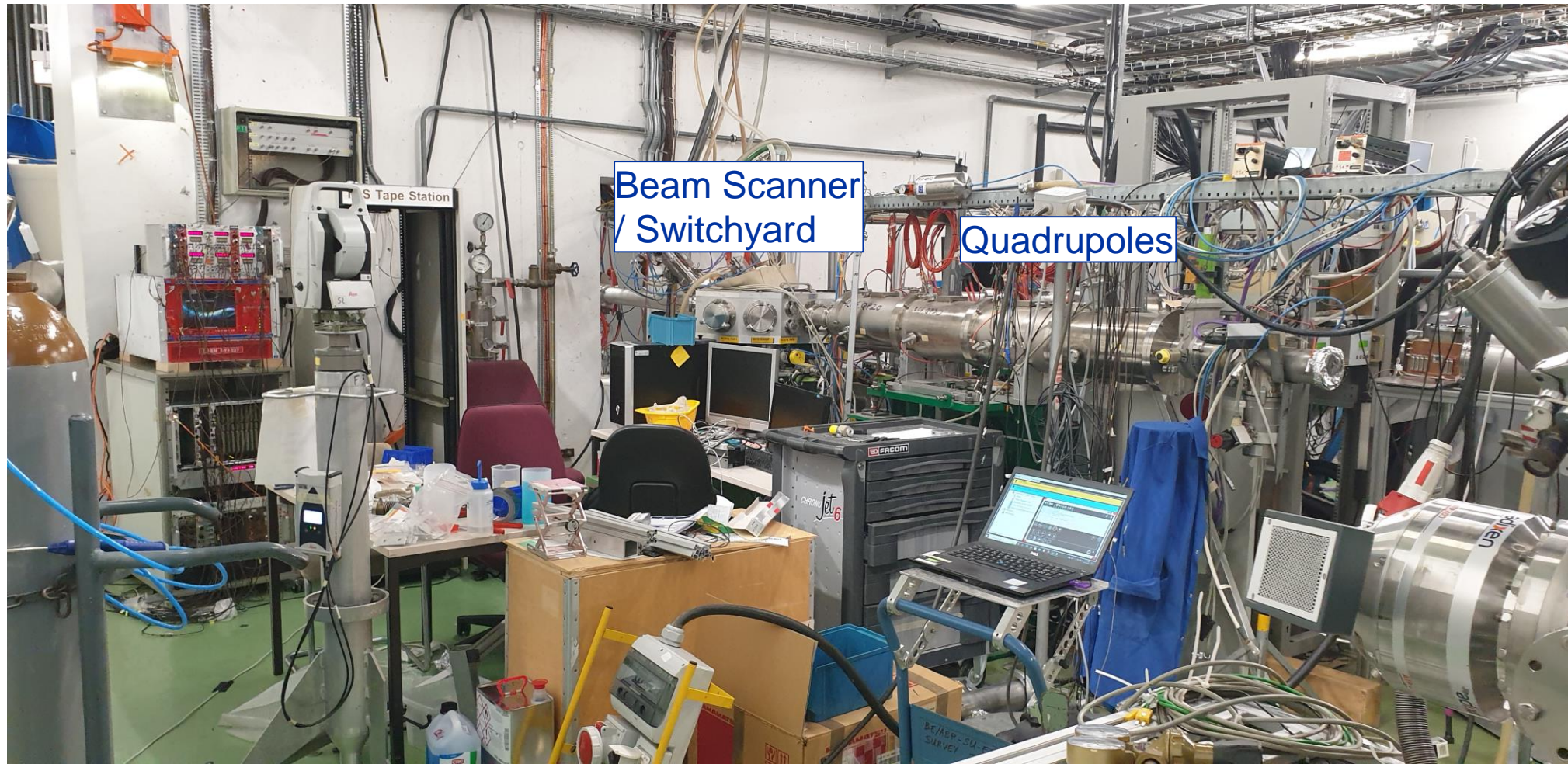

Beamline upstream of PUMA

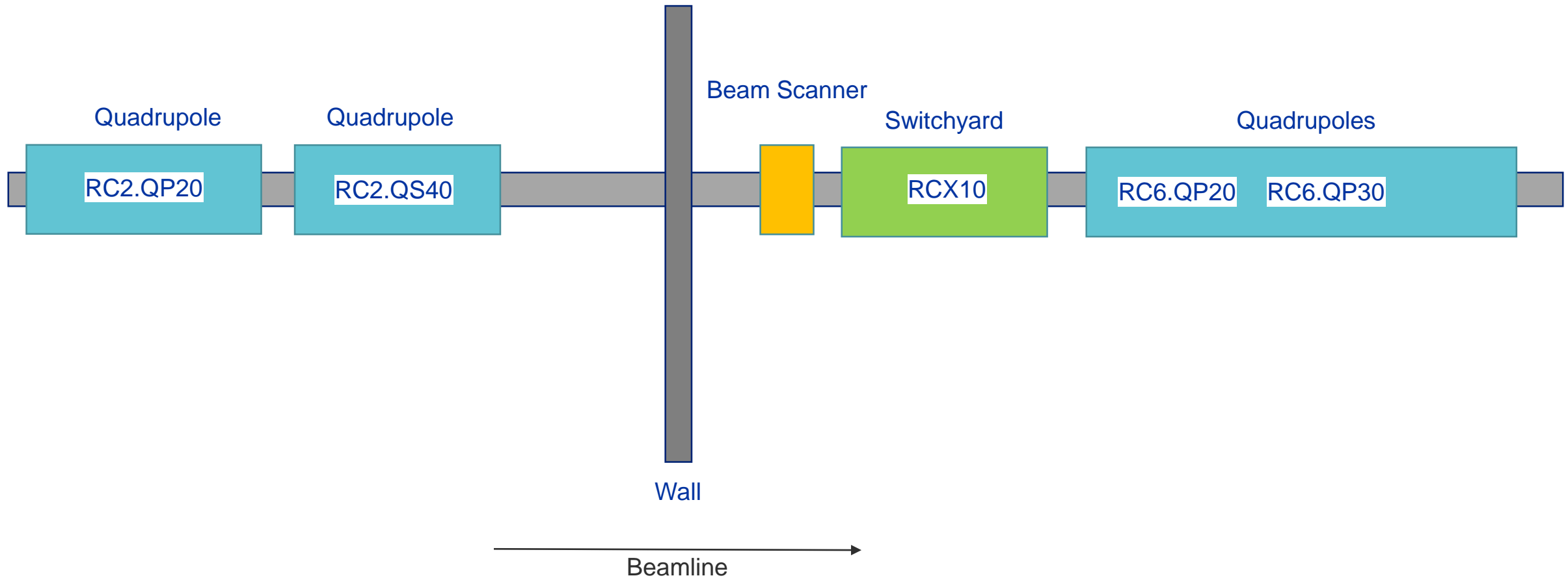

Quadrupole

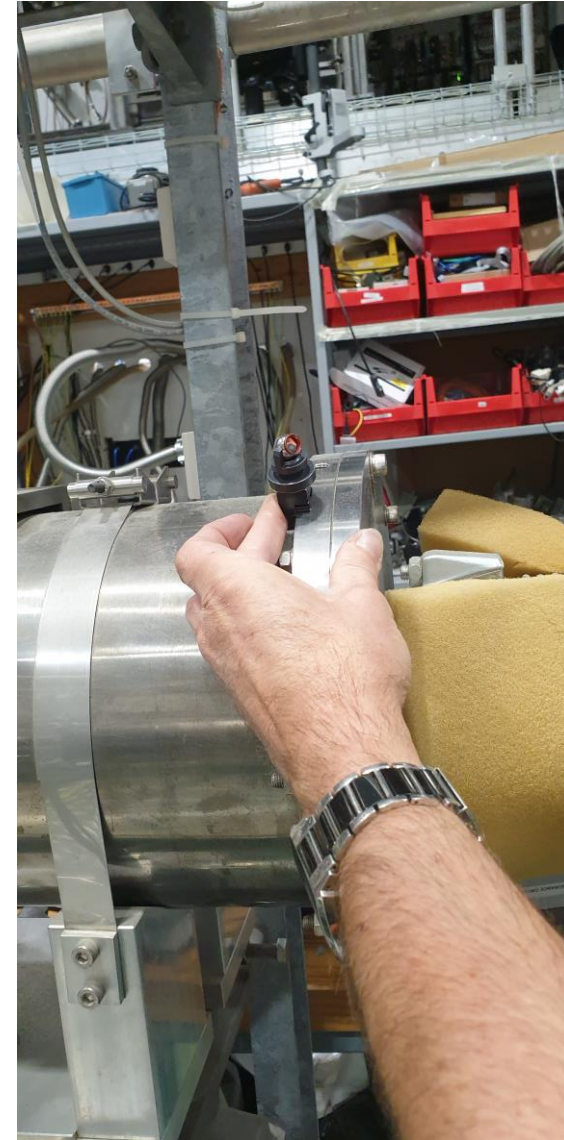
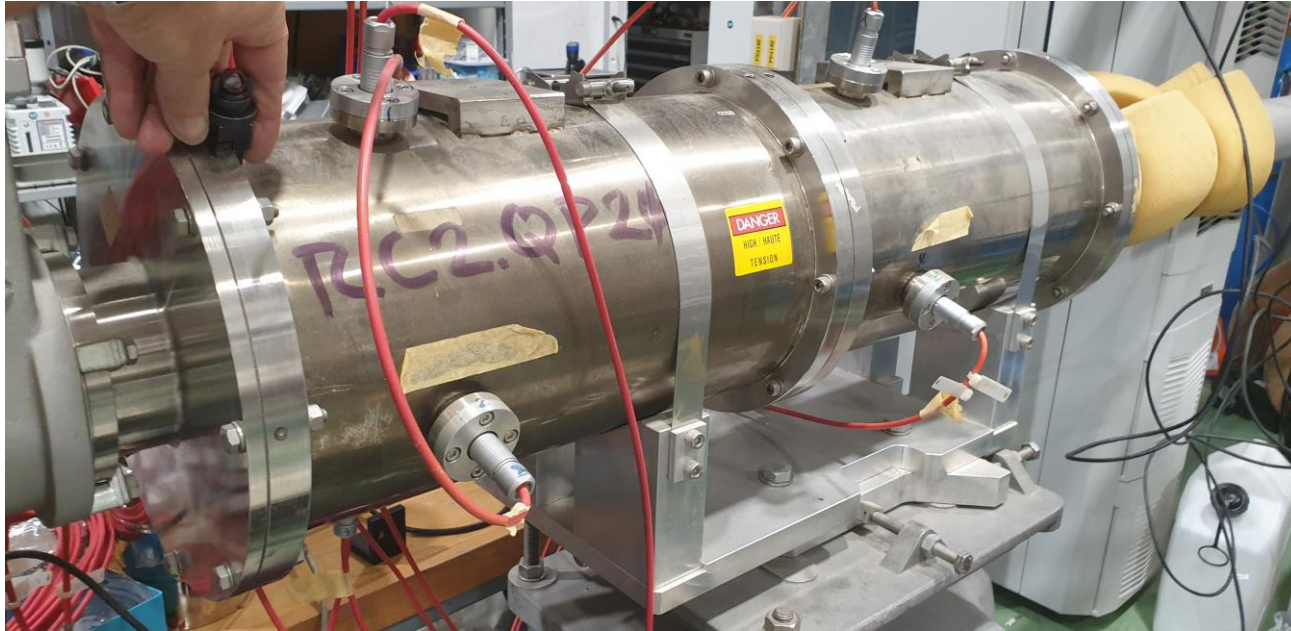

Quadrupole

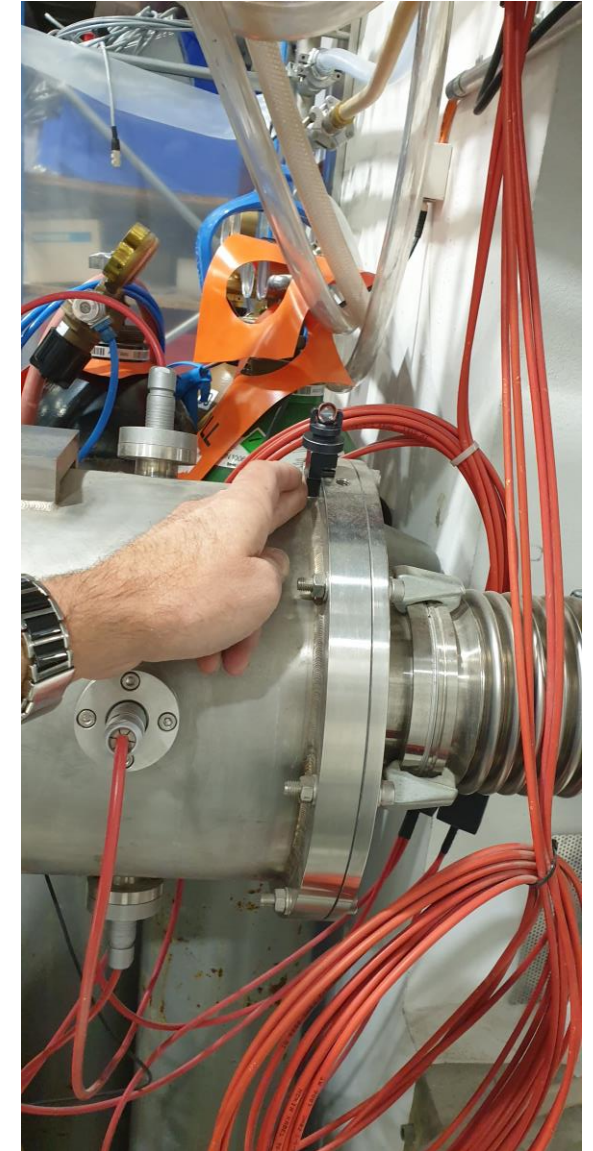

Beam Scanner / Switchyard

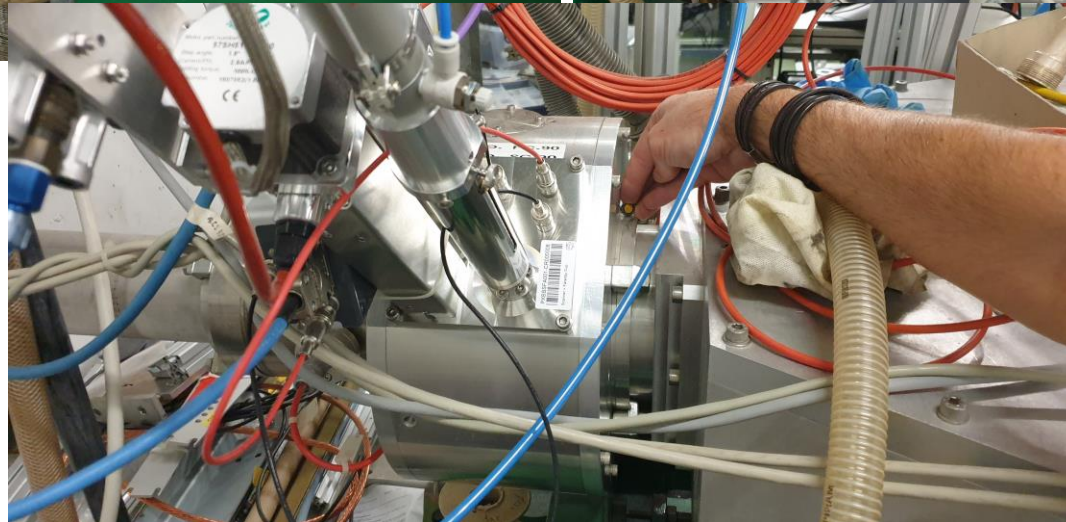
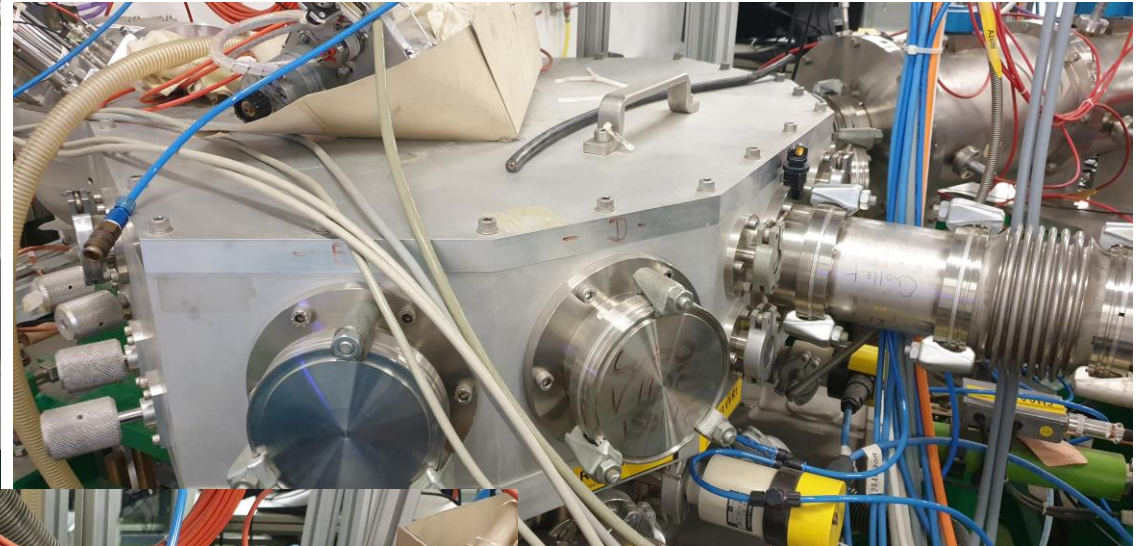
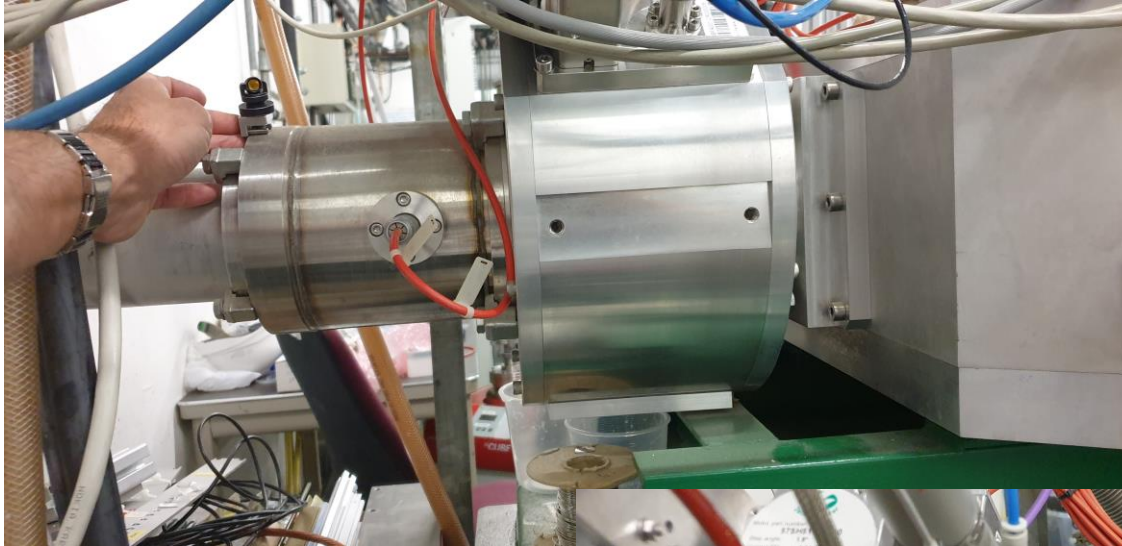

Quadrupoles

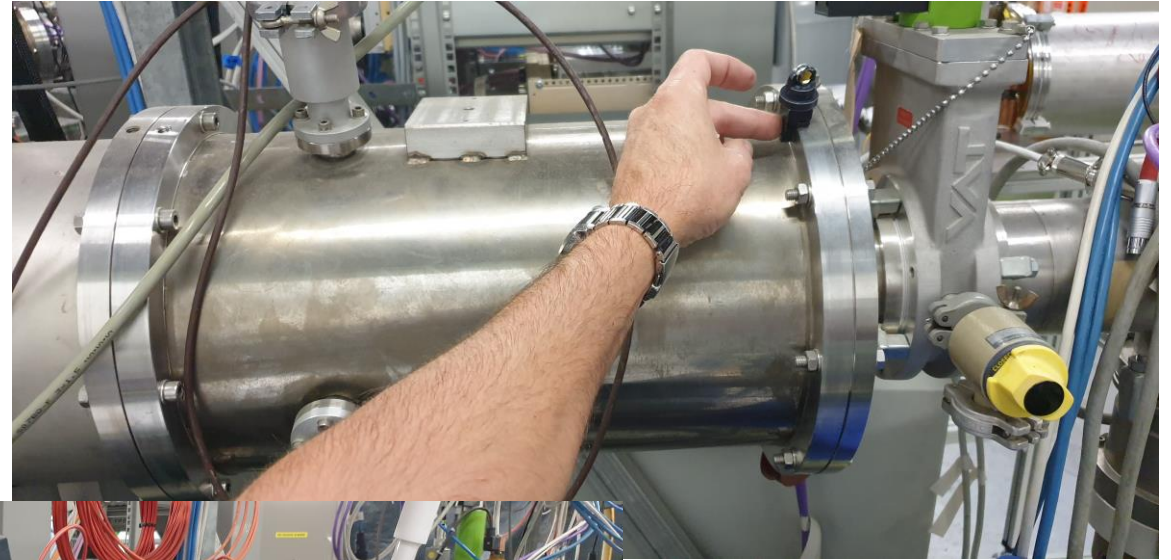

Results to mean line

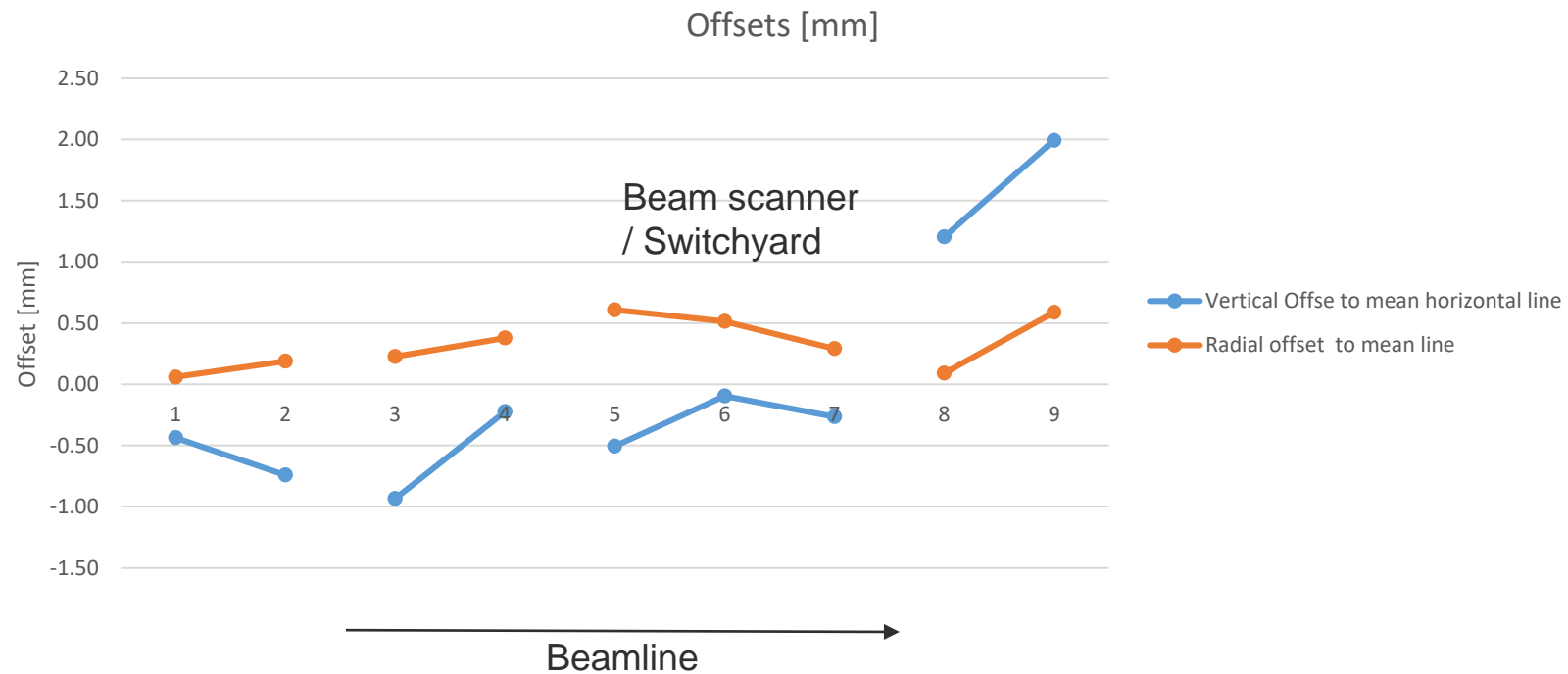

Coordinates in CCS will be sent within report on EDMS.

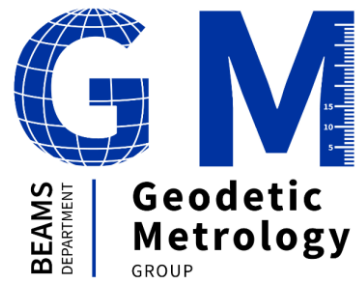

home.cern