

Workshop on Long Lived Particles

--200 MCHF??--

Albert De Roeck
CERN, Geneva, Switzerland

21th June 2023



Discussion

- Why 200 MCHF? What defines the number
- We have the LHC and its detectors/cavern..
 - Additional detectors is a compromise/optimization... some measurements not easily possible in central detector..
 - Extra caverns? FPF, other?
 - Upgrade existing detectors -> upgrades for HL-LHC ongoing for run4, eg timing added, muon area
 - More upgrades to study/explore?
- Beyond LHC:
 - “Active” caverns: eg HECTATE
 - Extra Caverns: DELIGHT nearby MATHUSLA
- Non- LHC experiments? Eg DAMSA, SHIP, Shadows...; opportunities at Neutrino experiments/beam dump
- Experiments in outer space, on the moon? (Jupiter...)
- Using cosmic rays? (Eg monopoles and HNLs in Icecube)

New Directions/Detectors

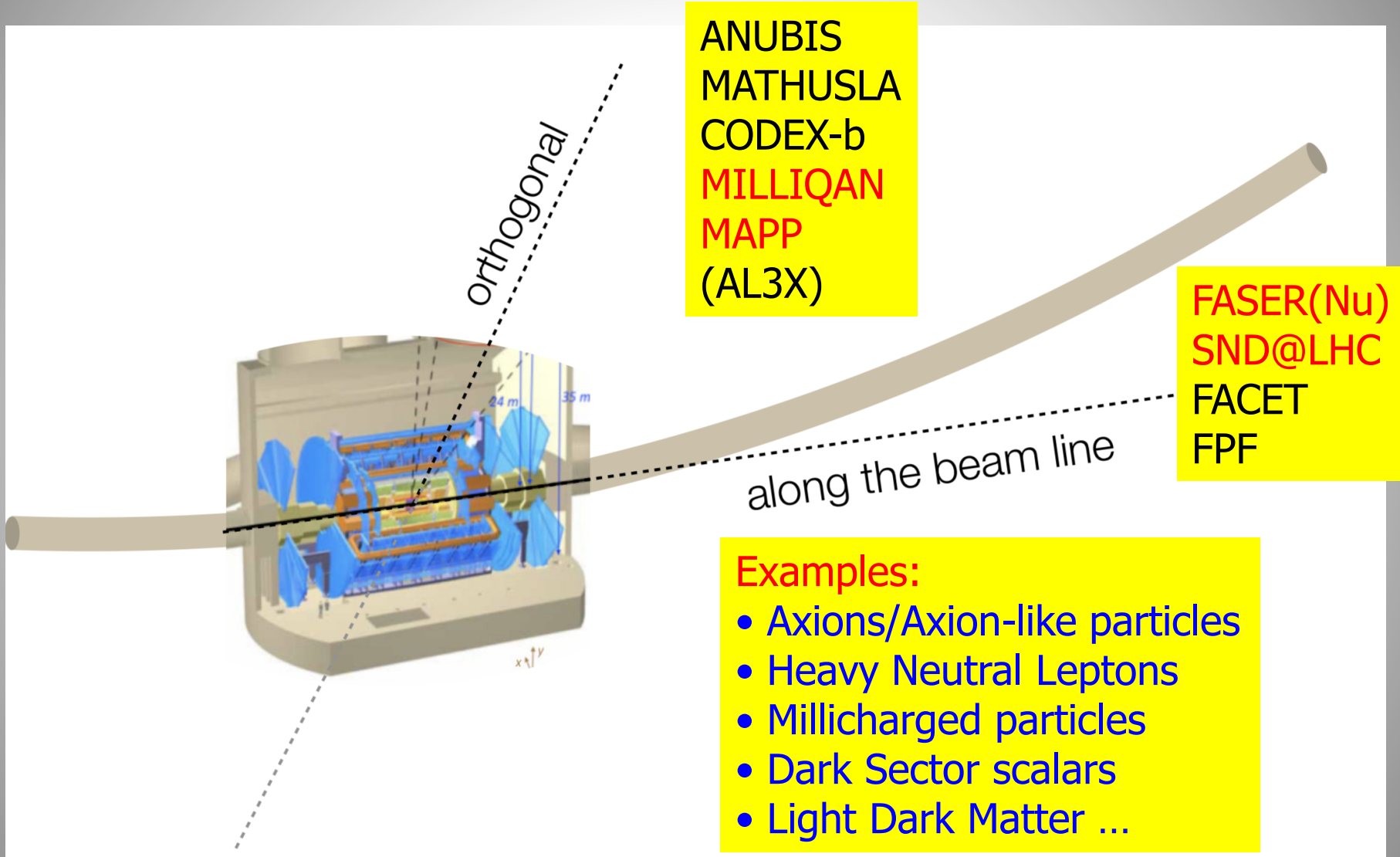

“Transverse Experiments” have minimal to no impact on the LHC machine

New Transverse Experiment Proposals

MilliQan: searches for millicharged particles
MAPP: MoEDAL upgrade

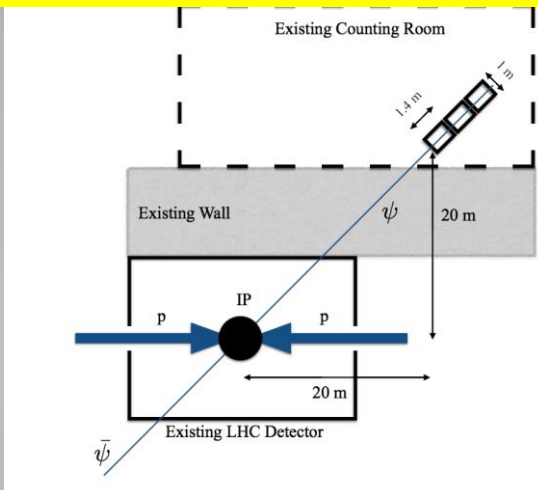

CODEX-b: searches for long lived weakly interacting neutral particles

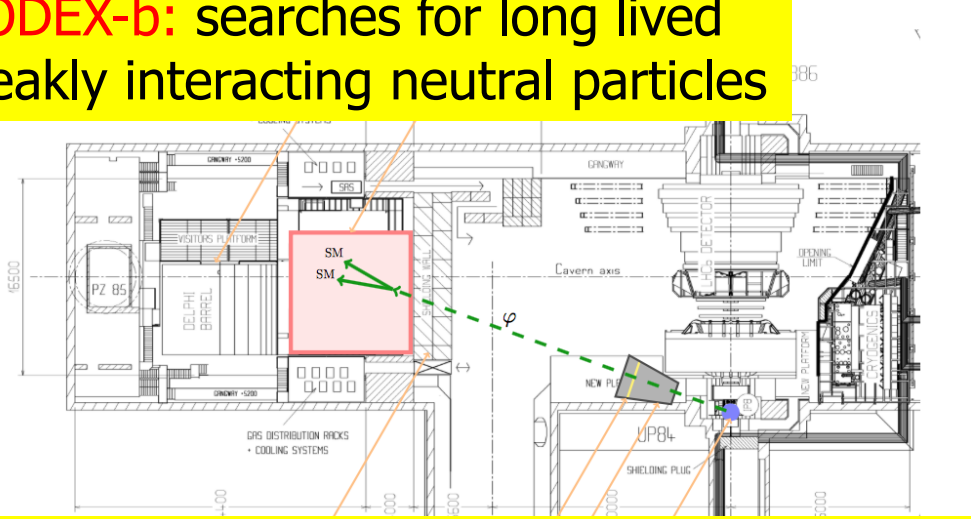

Also: **AL3X** ('ALICE' for LLP arXiv.1810.03636).

MATHUSLA: searches for long lived weakly interacting neutral particles

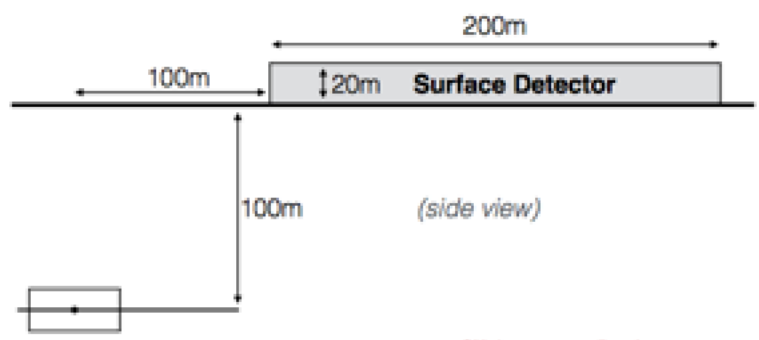

ANUBIS: searches for long lived weakly interacting neutral particles

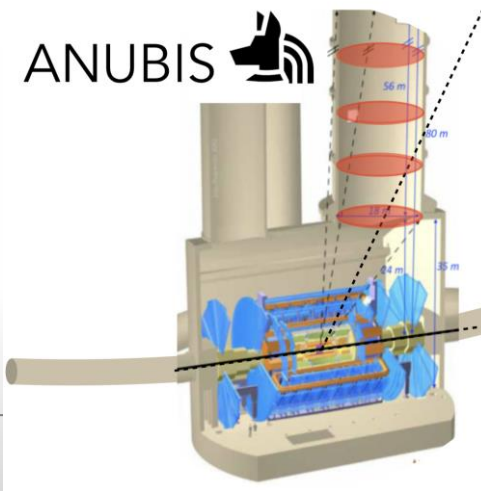

+Recently (2021): a new detector for CMS cavern..

New Forward Detector Proposals

FASER: searches for long lived dark photons-like particles, neutrinos

- typical rates $\sigma \sim \text{fb} - \text{pb}$

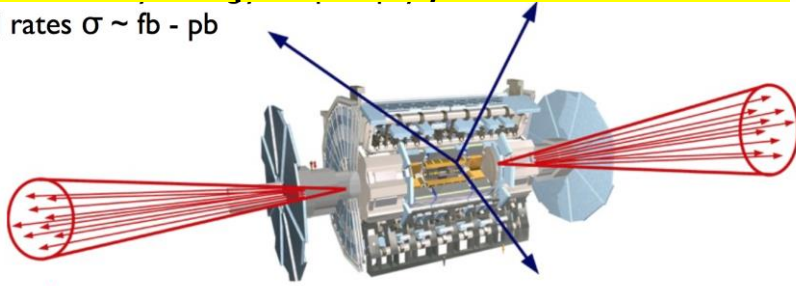

FACET: Instrumented Beampipe for CMS

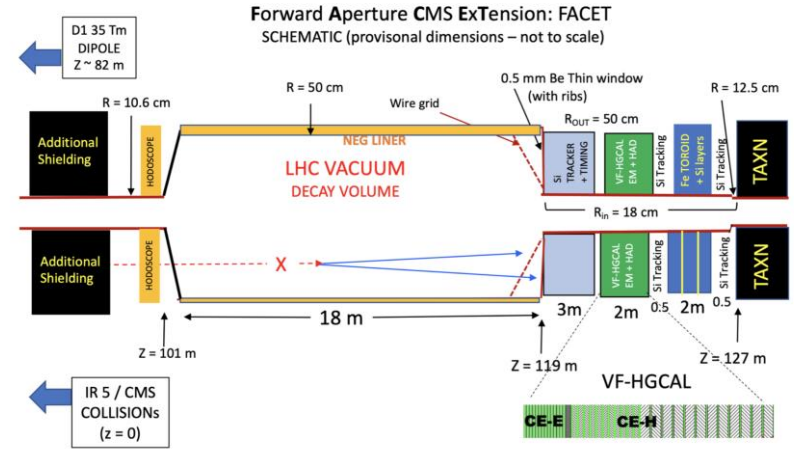

SND@LHC: neutrino measurements and long lived particle searches

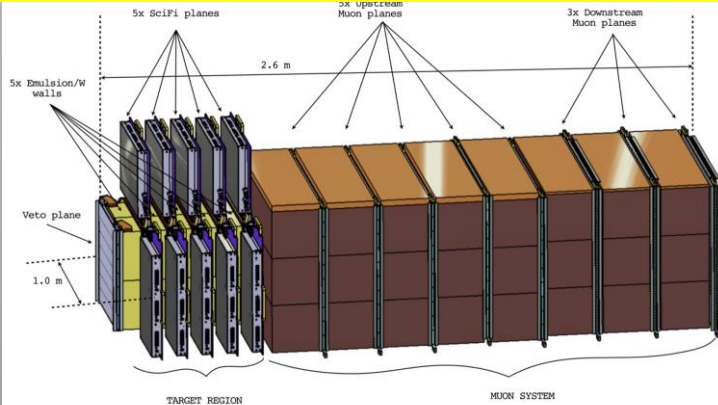
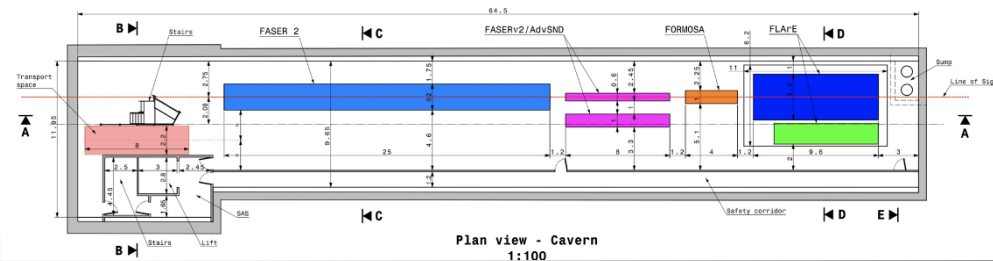

Figure 5: Layout of the proposed SND@LHC detector.

FPS: A Facility for Forward Physics Containing several experiments



FASER and SND@LHC have been approved in 2019/2020 and will be ready to take data during Run 3 starting next month

Transverse Detectors

Comparison of detector design — Neutral LLPs @ LHC

	Collision point	Distance from IP	Fiducial volume	Use main experiment?	Shielding cosmics	Shielding collision	Technology
MATHUSLA	CMS	~90 m	25m x 100m x 100m	Under study	NO	YES	Scintillators (+ 1 RPC)
ANUBIS	ATLAS	~25 m	~56m x (9m) ²	YES	Partial	NO	RPC (scintillators to be explored)
CODEX-b	LHCb	~35 m	10m x 10m x 10m	Under study	YES	YES	RPC
AL3X	ALICE	~4.25 m	~12m x (2.5m) ²	NO	YES	YES	Gas TPC

- For a given decay volume,
 - More solid angle if closer to the IP
 - Number of decays higher if closer to the IP
 - LHC collision backgrounds more important if closer to the IP (depending on shielding)

DELIGHT: idea for a LLP detector at FCC-hh

Long-Lived Light Mediators from Higgs boson decay studied for multiple decay modes of the scalars

2111.02437

DELIGHT (C): The same decay volume as the MATHUSLA detector with different dimensions, i.e. $\Delta x \times \Delta y \times \Delta z = 200 \times 50 \times 50 \text{ m}^3$.

DELIGHT
 Detector for long-lived particles at high energy of 100 TeV

$x_1 = 25 \text{ m}$
 $y_1 = 0 \text{ m}$
 $z_1 = -\Delta z/2$

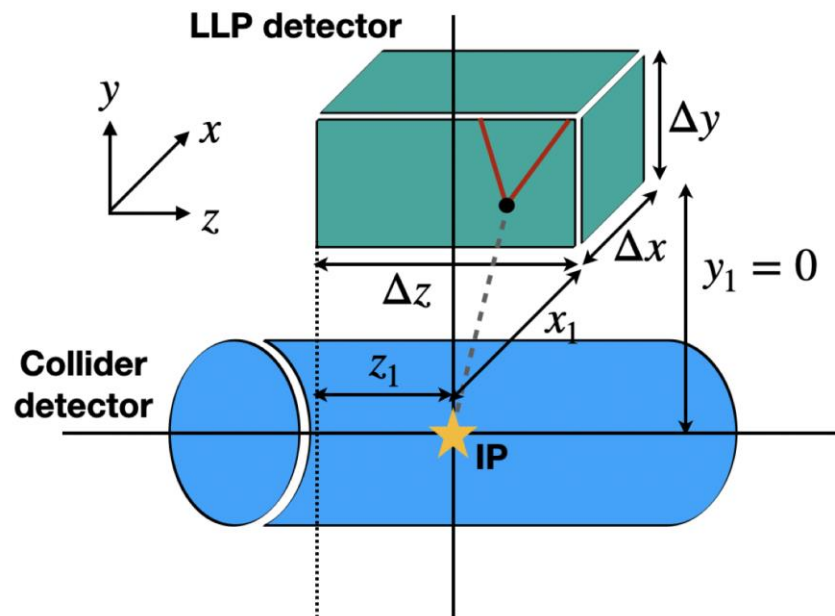
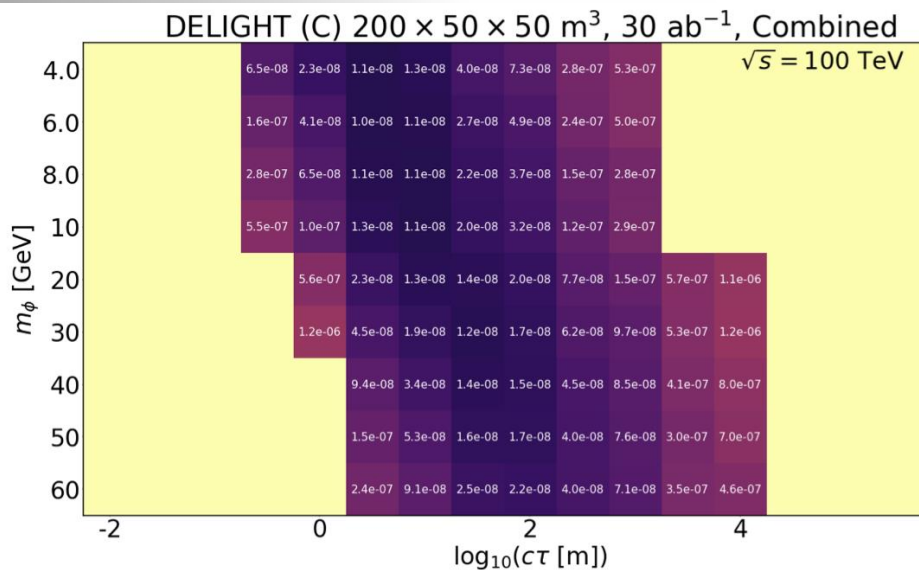

LLP @ Next Collider Projects

Proposal: [2011.01005](#)

LLPs @ FCC-hh, FCC-ee

HECATE: HErmetic CAvern TrackER. A long-lived particle detector concept for FCC-ee or CEPC

- For FCC-hh / FCC-ee, main detector will be relatively smaller than the cavern
- Cover detector cavern walls with scintillator plates or RPCs
 - ≥ 2 layers of 1 m^2 separated by a sizeable distance — timing
 - ≥ 4 layers for good tracking
 - 4π coverage LLP detector
- FCC main detector as active veto
- Sensitive to a unique area of phase space

- Example: HNLs
- THUNDERDOME: Totally Hyper-UNrealistic DEtectoR in a huge DOME (maximum distance from IP= 100m for comparison)

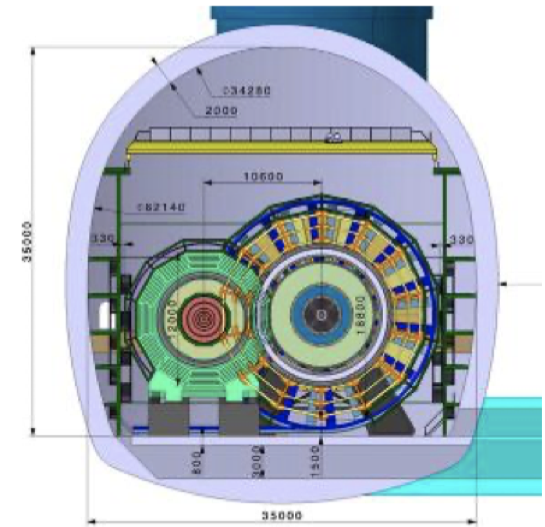
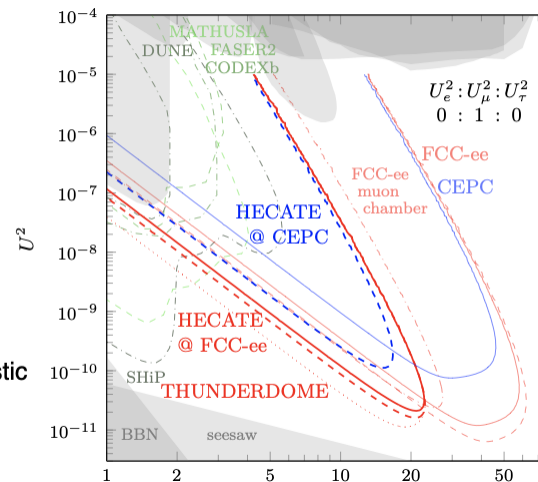

- Cavern size: $r \sim 15 \text{ m}$ and $z \sim 50 \text{ m}$
- Main detector size = (10m)

Important: take LLP requirements into account from the start (Snowmass2021)

A Crazy Idea?

2004.08820

- LLPs can escape the detector at the collision point and accidentally decay in the vicinity of detectors far away. Spooky?
- Estimates using ATLAS and ALICE for (favourable) Hidden Valley scenario, detecting the muons..

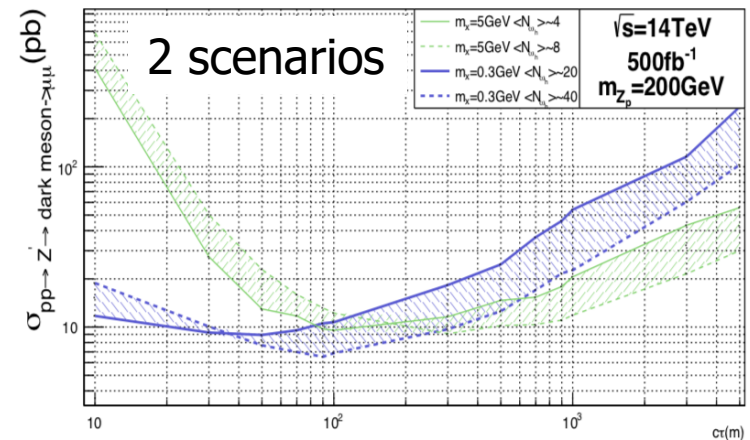
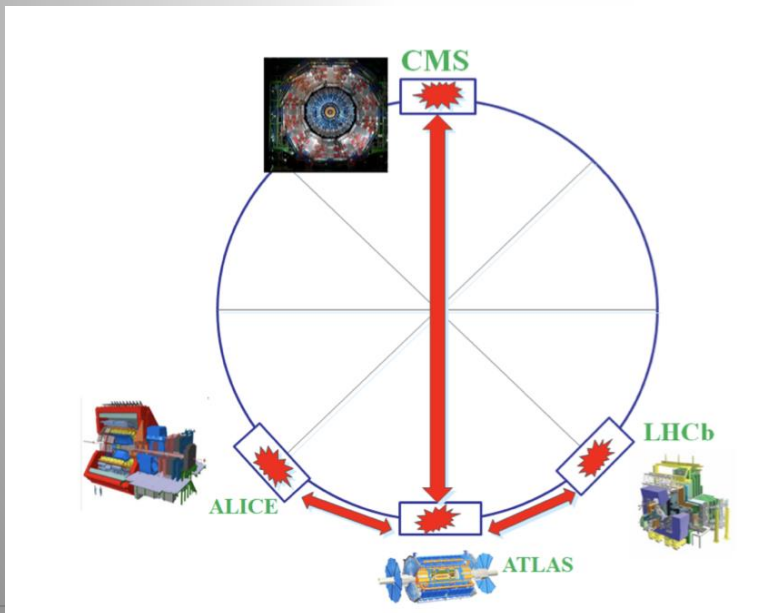
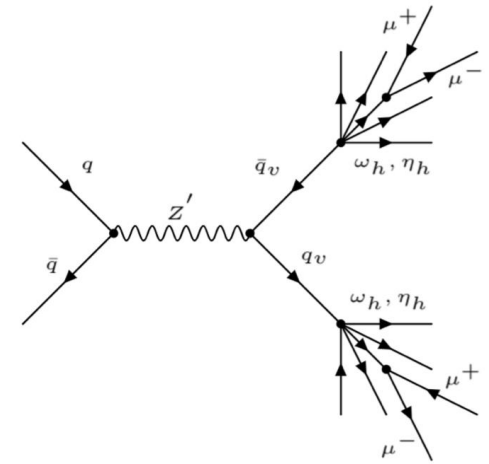

Careful: some flaws in the numbers in this paper

Quirk Study in CMS

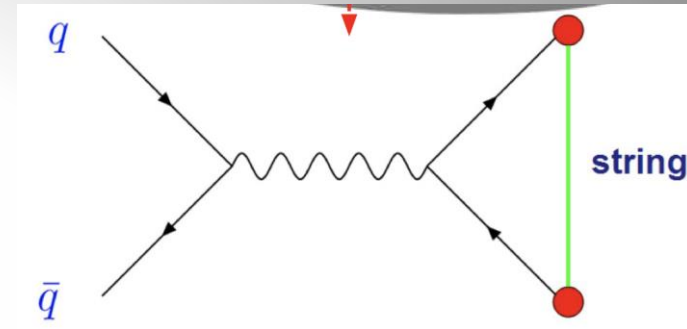
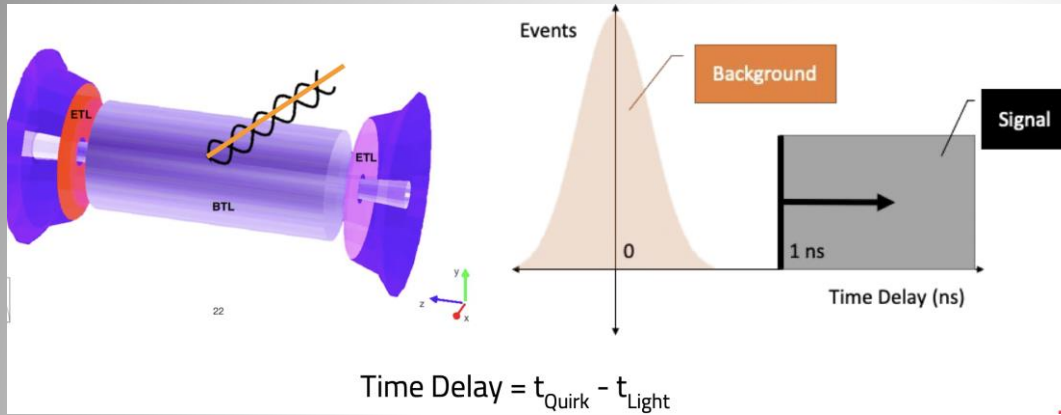

Nathan Suri
Work in progress...

