

Introduction to Plasma Physics

Vinícius N. Duarte

Princeton Plasma Physics
Laboratory
Princeton University, USA

Introductory Plasma Physics Course
INFIERI, August 29th 2023

Outline

- What is plasma?
 - Occurrence and applications
 - Criteria for plasmas
- A few key concepts
 - Debye length
 - Plasma oscillations
 - Gyrofrequency
 - Alfvén waves
- Summary

Outline

- **What is plasma?**
 - Occurrence and applications
 - Criteria for plasmas
- A few key concepts
 - Debye length
 - Plasma oscillations
 - Gyrofrequency
 - Alfvén waves
- Summary

Matter exists in distinct forms

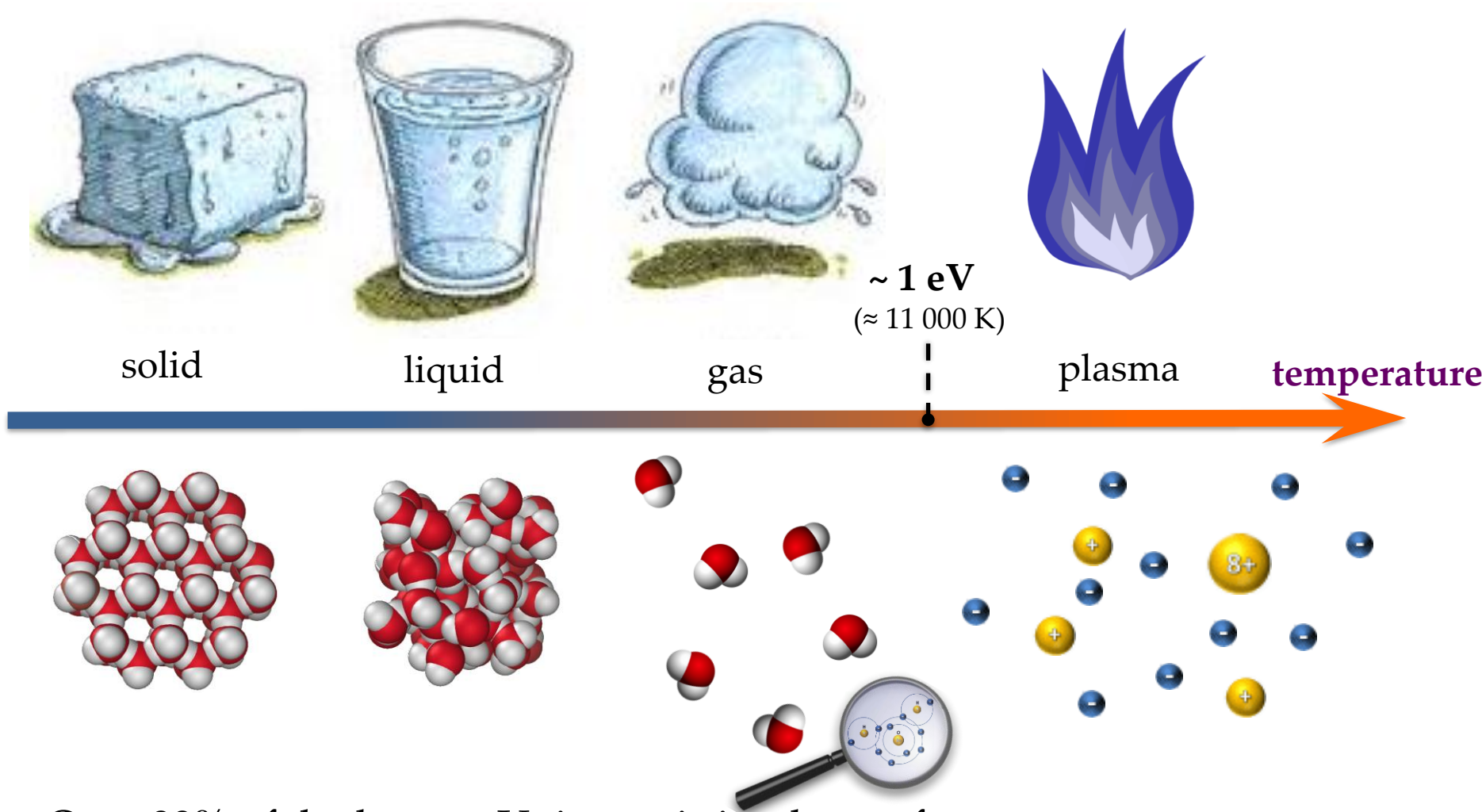

- Over 99% of the known Universe is in plasma form
- Modern telescopes suggest that the Universe is comprised by $\sim 4.6\%$ baryonic (ordinary) matter, $\sim 26.8\%$ dark matter, and $\sim 68.3\%$ dark energy

What is a plasma?

- In Ancient Greek, πλάσμα (plásma): 'moldable substance'
- The term "plasma" for an ionized gas was coined in 1927 by Irving Langmuir, because how an electrified fluid carried ions and electrons reminded him of how blood plasma carried red and white corpuscles.

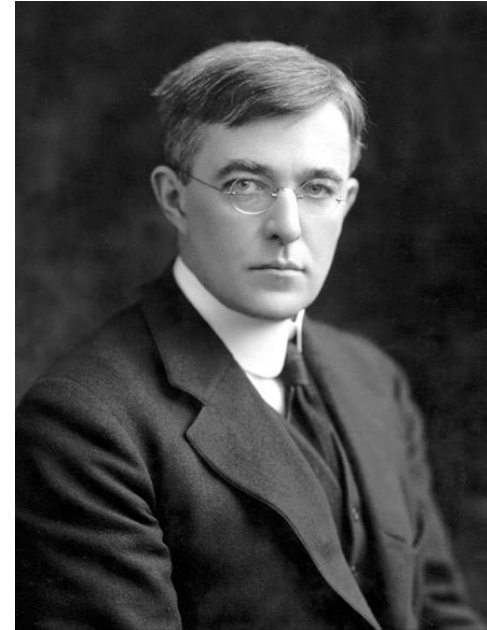

Irving Langmuir
(1881-1957);
Chemistry Nobel
Prize 1932

Definitions of plasmas

“Plasma is in some sense the natural, untamed state of matter...”

-Hazeltine and Waelbroeck, *The Framework of Plasma Physics*

“physical systems whose intrinsic properties are governed by collective interactions of large ensembles of free charged particles.”

-NSF Basic Plasma Science and Engineering Website

A more formal definition will be given towards the end of this lecture

Star Birth - Eagle Nebula



Color pattern corresponds mostly to emissions from singly-ionized sulfur atoms (red), hydrogen (green) and doubly-ionized oxygen atoms (blue).

Aurora



Disturbances in the upper atmosphere caused by the solar wind (e.g., due to coronal mass ejections) lead to ionization and of atmospheric constituents that emit light of varying color and complexity

Matter around black holes

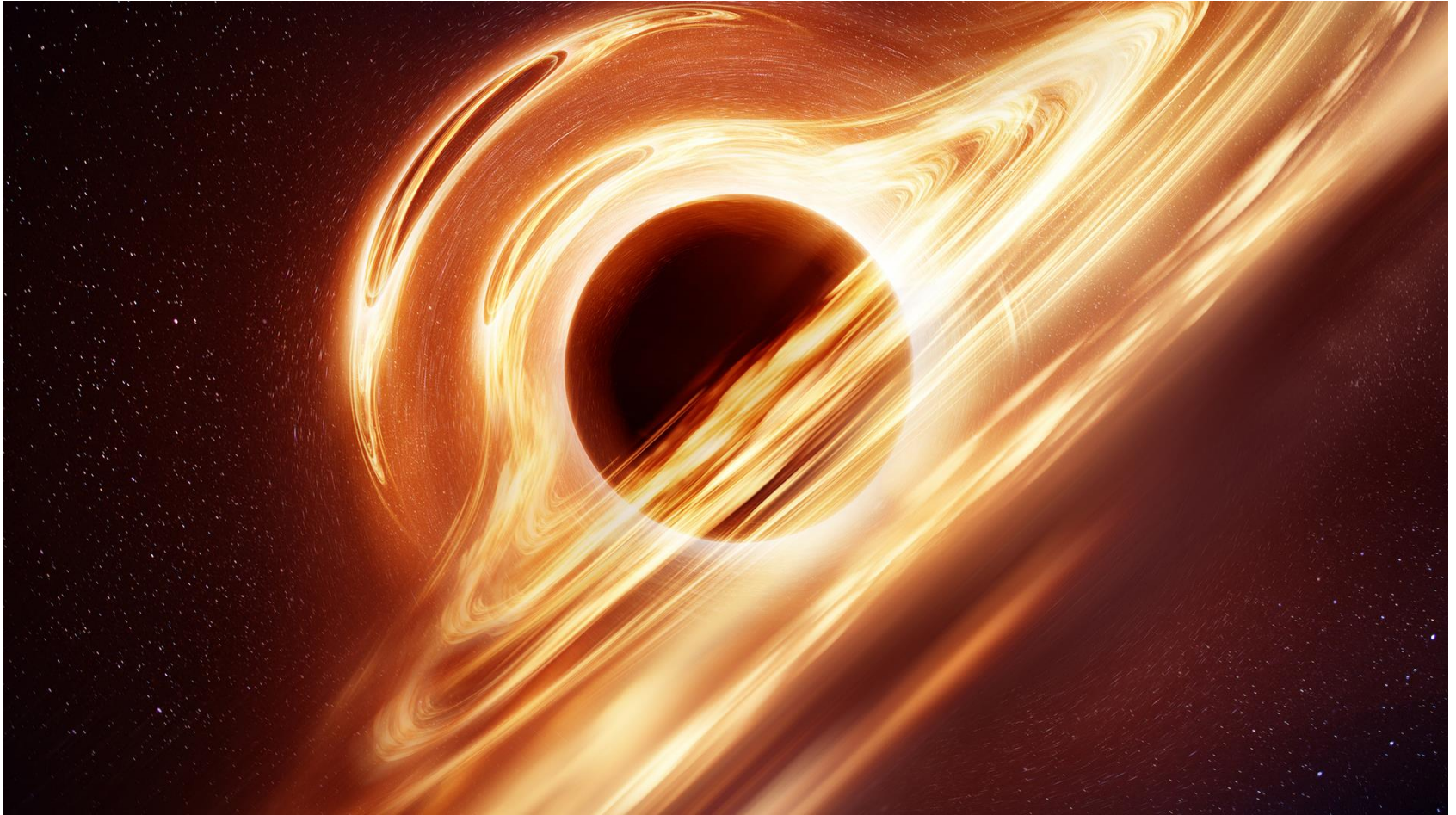

As matter is drawn to a black hole, and its immense gravitational influence creates turbulent and violent conditions, heating gas and stripping electrons away from its constituent atoms.

Technological applications

- Plasma pencil
- Plasma torch
- Plasma TV
- Fluorescent lamp
- Plasma thrusters for space travel
- Controlled thermonuclear fusion
-

Plasma torch



Useful in many applications, such as metal cutting, welding and waste disposal

Plasma pencil

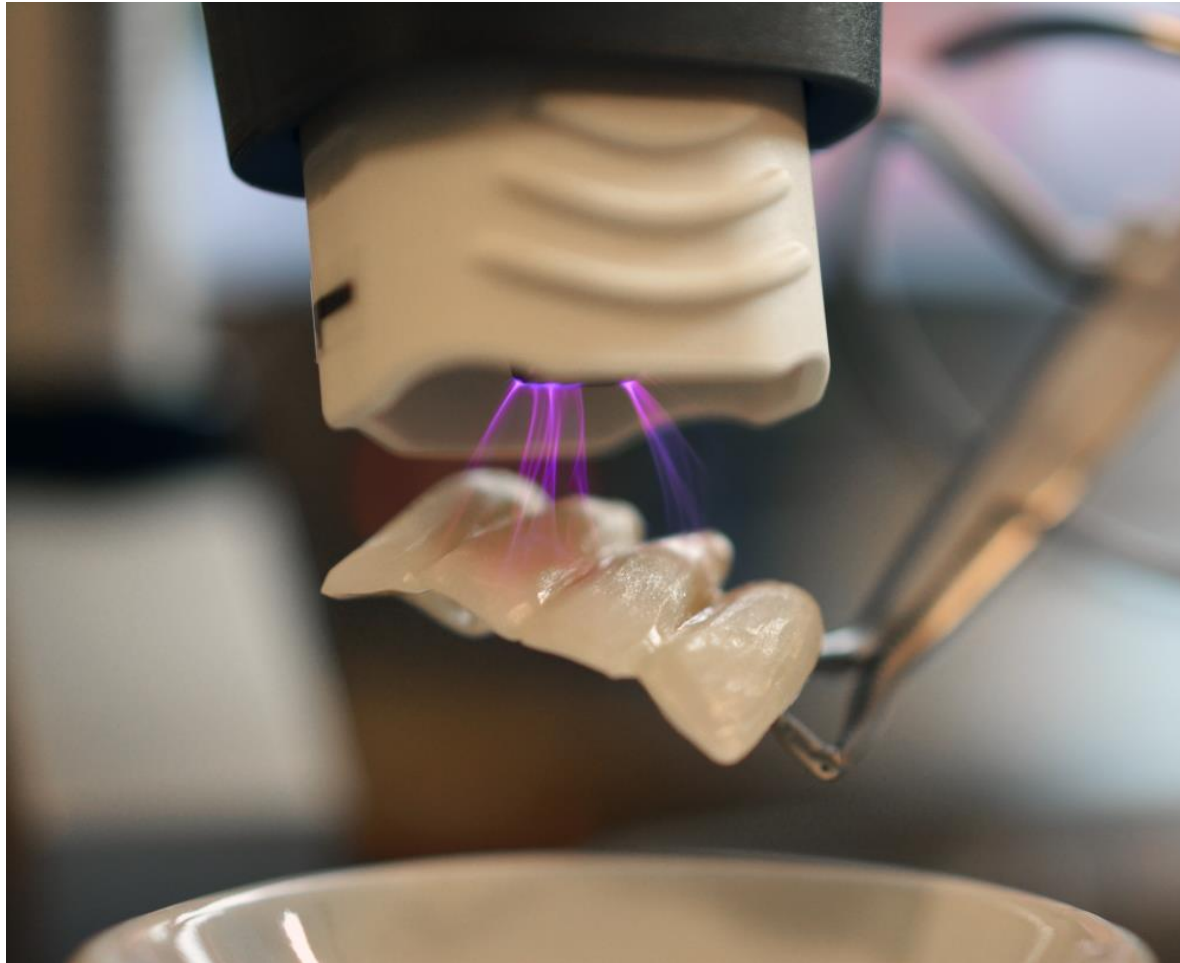

Used to treat and sterilize irregular surfaces, making them appropriate for decontaminating dental cavities without drilling

National Ignition Facility (NIF)

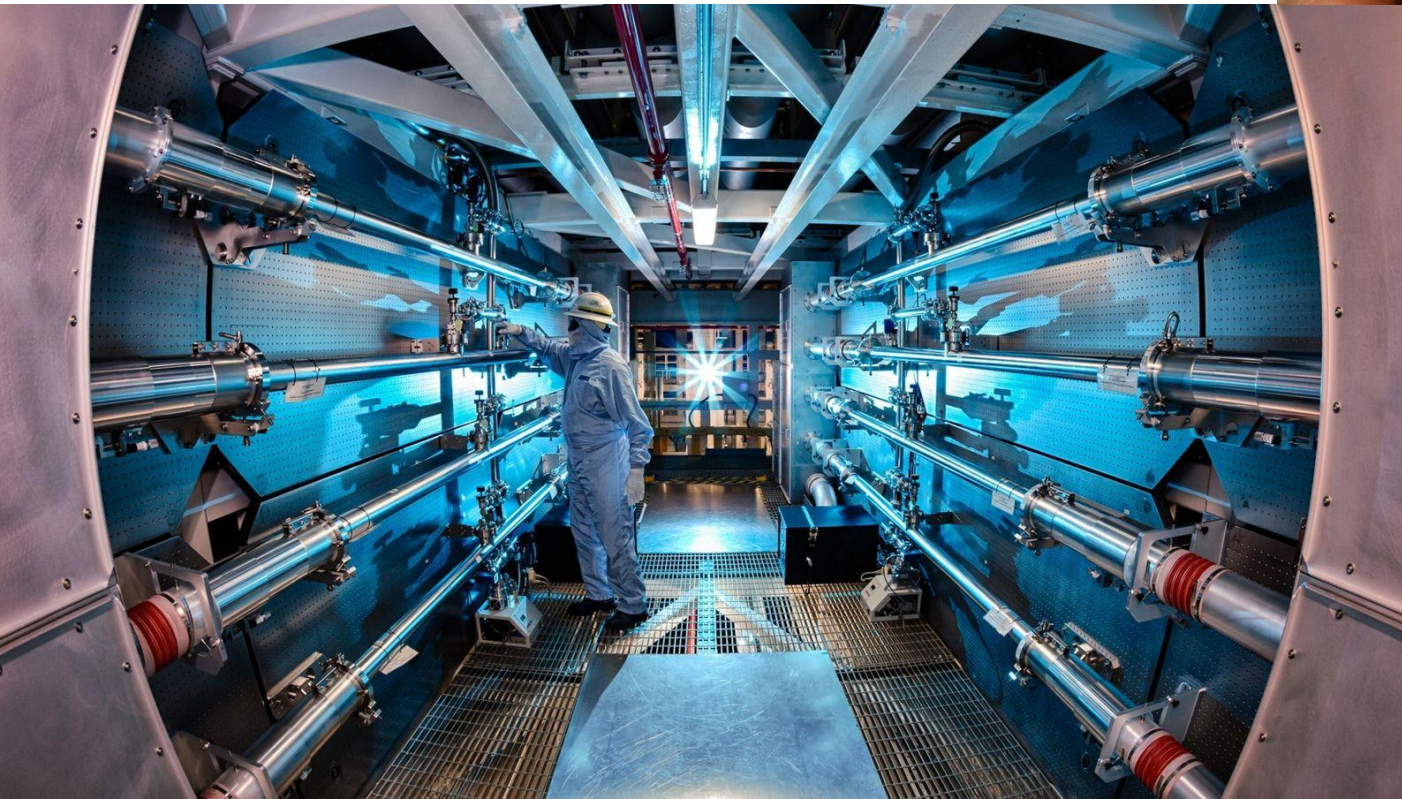
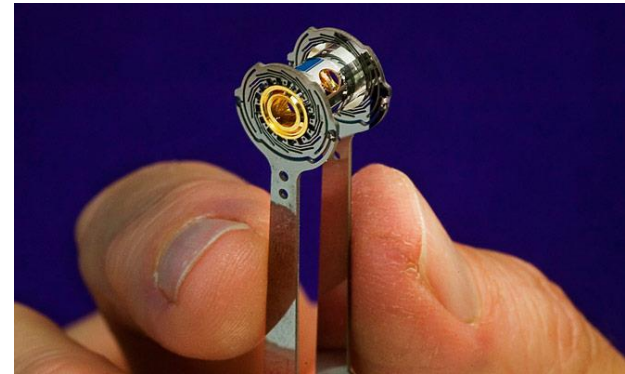

Inertial fusion

International Thermonuclear Experimental Reactor (ITER)

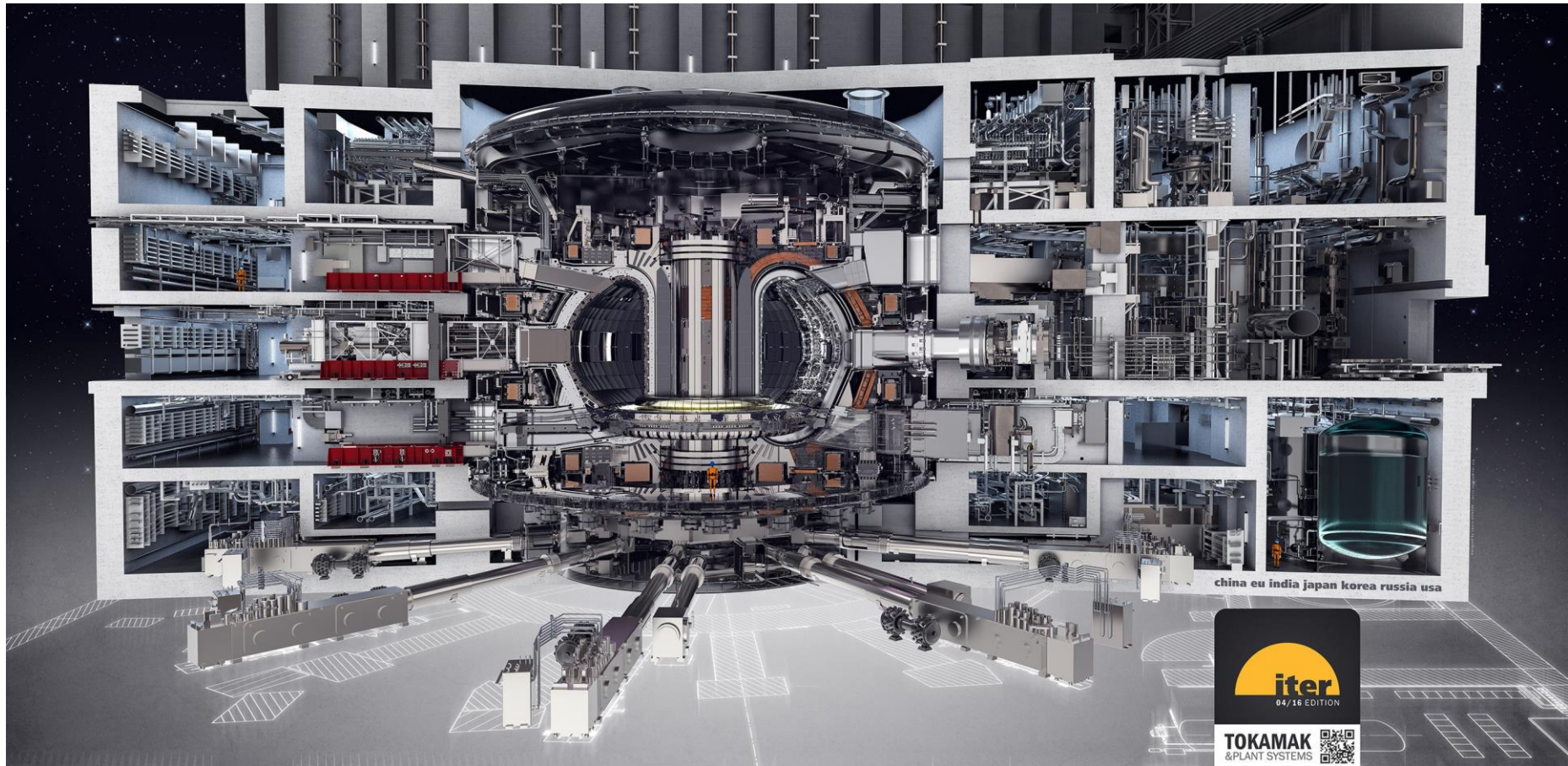

Magnetic fusion

A few tokamaks around the globe

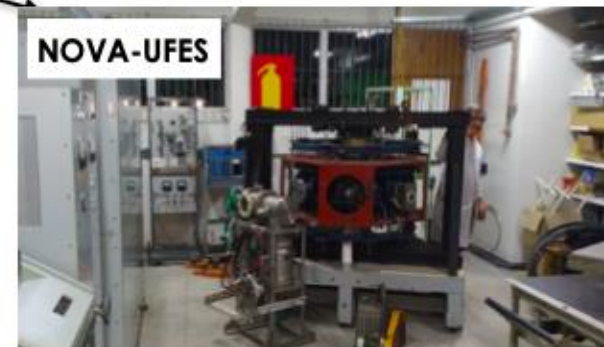
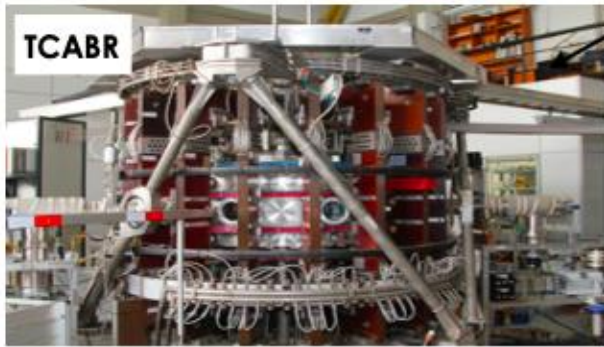
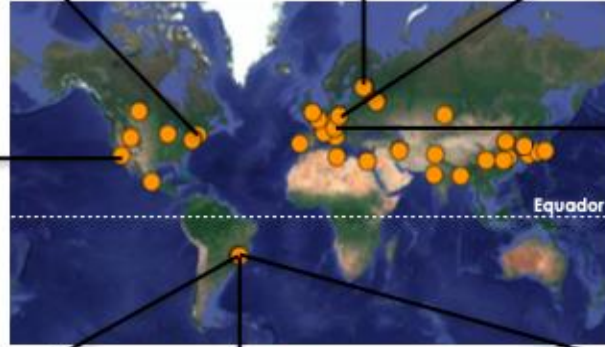
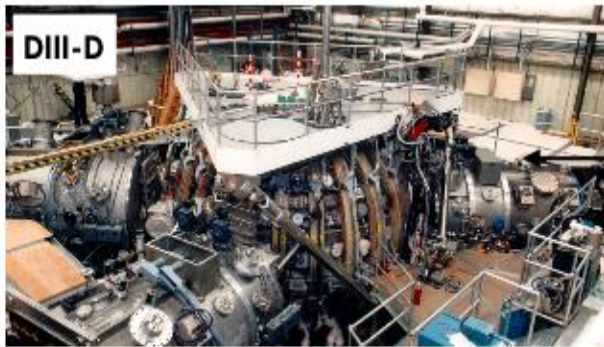

Plasmas occur within a wide range of parameters

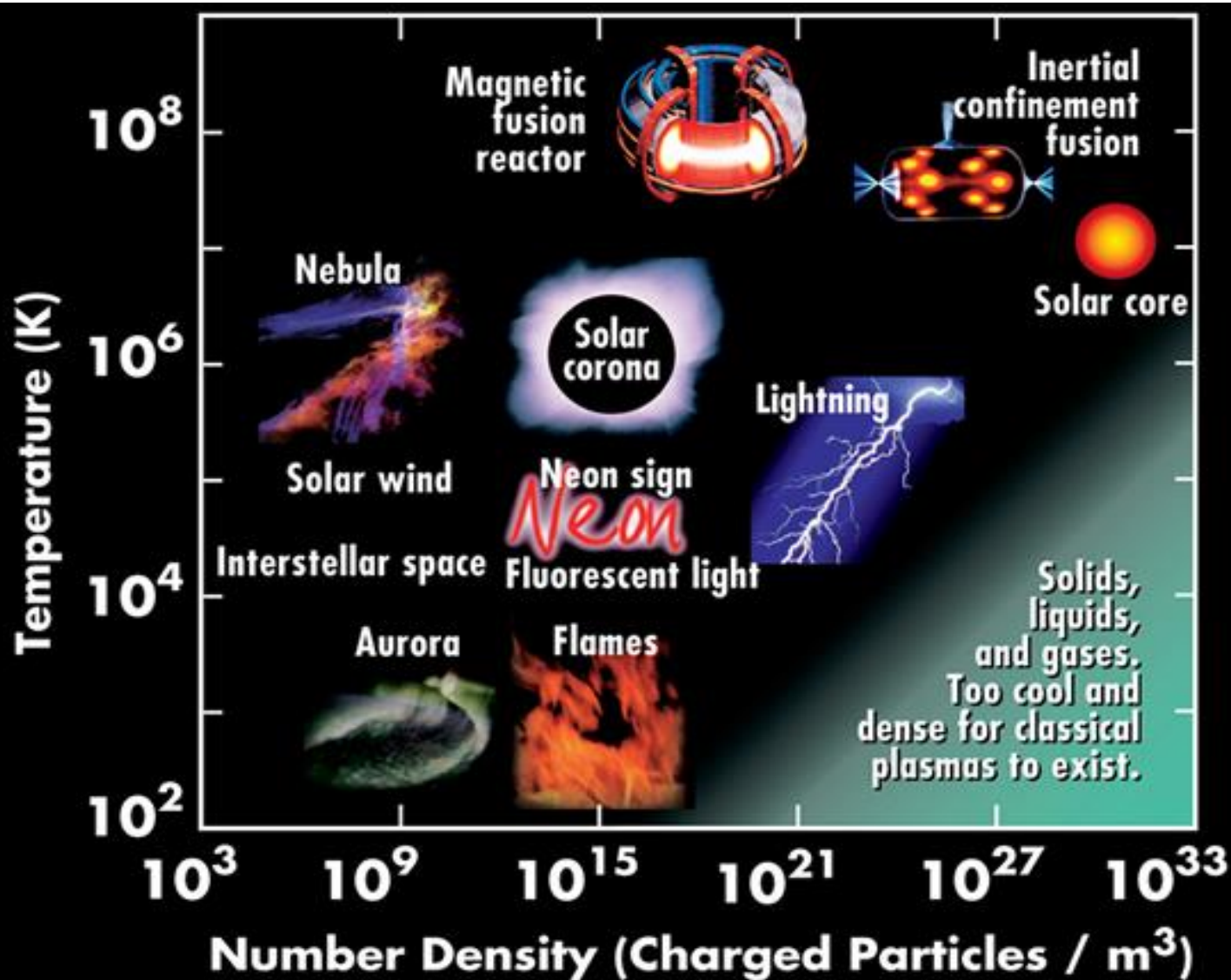

Image credit:
National
Ignition Facility,
Lawrence
Livermore Nat.
Lab.

Outline

- What is plasma?
 - Occurrence and applications
 - Criteria for plasmas
- **A few key concepts**
 - Debye length
 - Plasma oscillations
 - Gyrofrequency
 - Alfvén waves
- Summary

Studying plasmas involves many disciplines

- Electrodynamics
- Fluid mechanics
- Statistical physics
- Thermodynamics
- Quantum mechanics
-

Comparison between electric/gravitational forces

The electric and gravitational forces exerted on m_1 by m_2 are:

$$m_1 \vec{a} = \Sigma \vec{F} = \vec{F}_G + \vec{F}_E = \left[-\frac{Gm_1m_2}{r_{1,2}^2} + \frac{q_1q_2}{4\pi\epsilon_0 r_{1,2}^2} \right] \hat{r}$$

Assuming one is an ionized deuterium atom and the other is an electron:

$$\frac{F_E}{F_G} = 1.1 \times 10^{39}$$

Gravity is irrelevant for lab plasmas (but not for astrophysical ones)

Outline

- What is plasma?
 - Occurrence and applications
 - Criteria for plasmas
- A few key concepts
 - **Debye length**
 - Plasma oscillations
 - Gyrofrequency
 - Alfvén waves
- Summary

Debye shielding

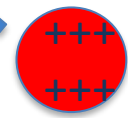
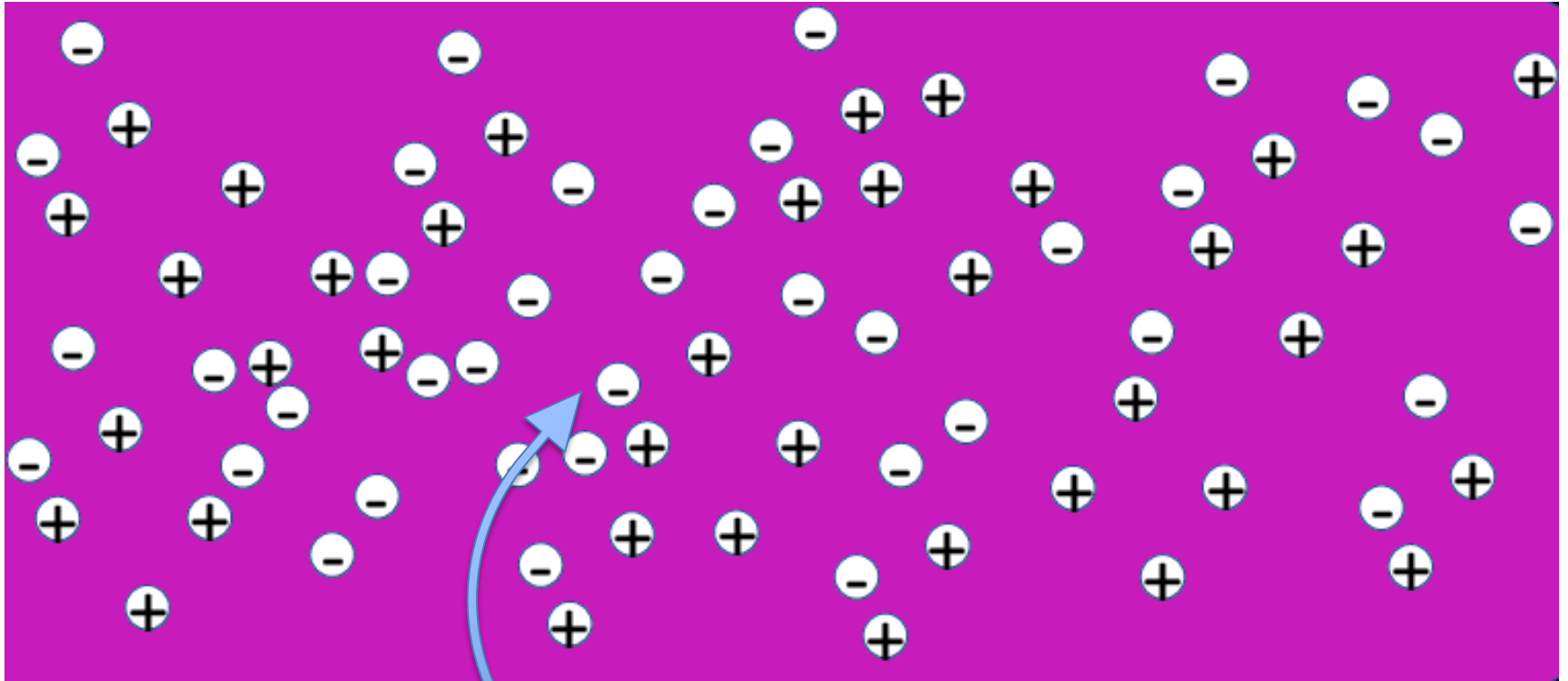

Place a test charge into a quasi-neutral plasma

Debye shielding

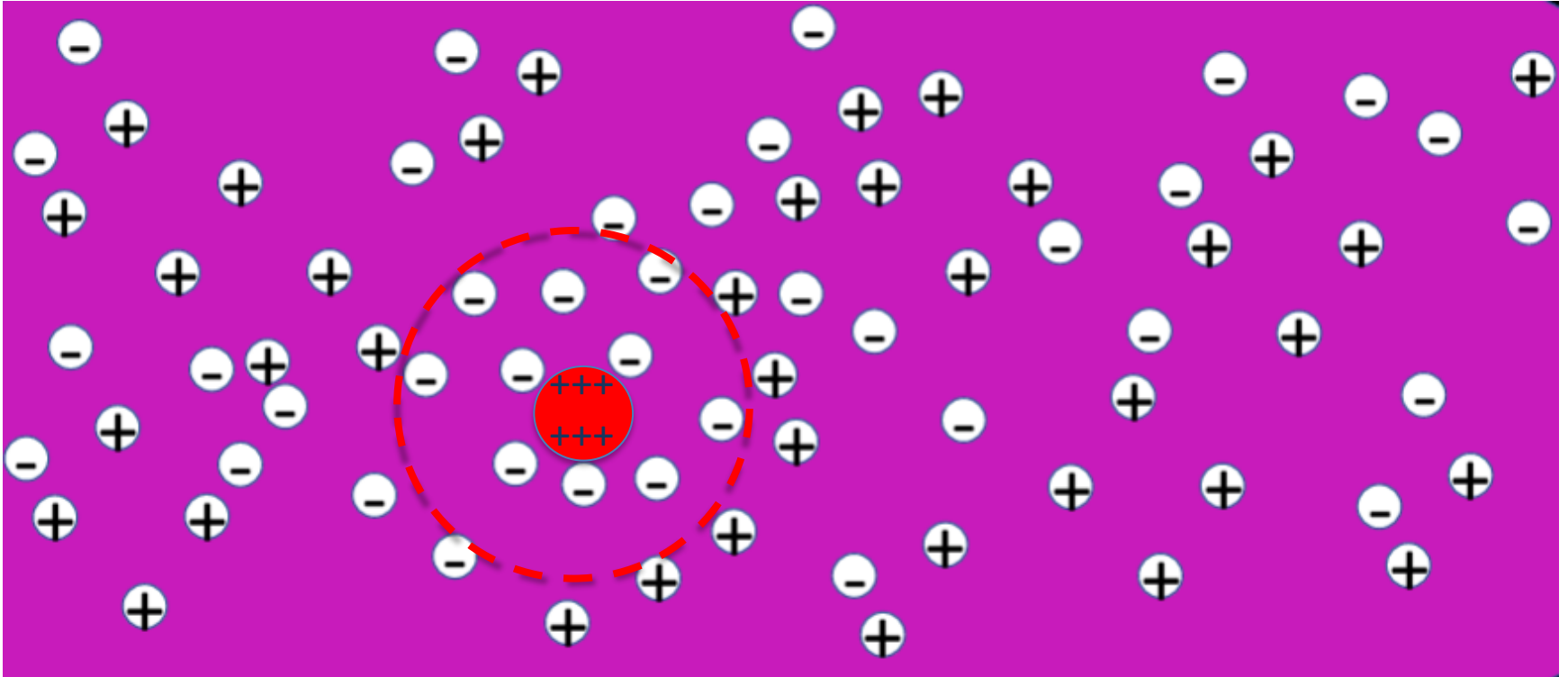

Key question: What is the radius of the sphere of influence of this extra charge? How far away do you have to be for the extra charge to be completely “shielded” by the plasma?

Debye shielding

– Poisson's Equation

$$\nabla^2 \Phi = -\frac{\rho_q}{\epsilon_0}$$

$$\nabla^2 \Phi = -Ze\delta(\mathbf{x}) - \frac{e}{\epsilon_0}(n_0 - n_e)$$

$n_e = n_0 e^{-\frac{e\Phi}{kT_e}}$

$$\nabla^2 \Phi = -Ze\delta(\mathbf{x}) - \frac{en_0}{\epsilon_0} \left(1 - e^{-\frac{e\Phi}{kT_e}}\right)$$

Debye shielding

- Debye length

Use $e\phi \ll kT$ to linearize equation

$$\nabla^2 \Phi \approx -Ze\delta(\mathbf{x}) - \frac{en_0}{\epsilon_0} \left(1 - \left(1 - \frac{e\Phi}{kT_e} \right) \right)$$

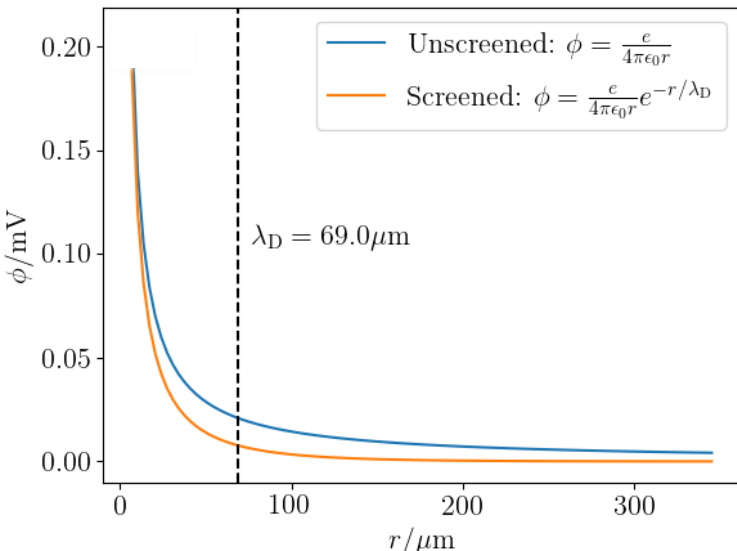

$$\nabla^2 \Phi - \frac{1}{\lambda_D^2} \Phi \approx -Ze\delta(\mathbf{x}) \quad \frac{1}{\lambda_D^2} = \frac{n_0 e^2}{\epsilon_0 kT_e}$$

$$\Phi(r) = \frac{Ze}{4\pi\epsilon_0 r} e^{\frac{-r}{\lambda_D}}$$

Typical Debye lengths:

Solar core: 10^{-11}m , Tokamak: 10^{-4}m , Intergalactic medium: 10^{+5}m

Outline

- What is plasma?
 - Occurrence and applications
 - Criteria for plasmas
- A few key concepts
 - Debye length
 - **Plasma oscillations**
 - Gyrofrequency
 - Alfvén waves
- Summary

Plasma oscillations

- Plasma frequency

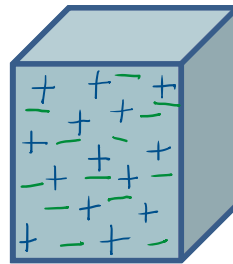

Plasma oscillations

- Plasma frequency
- Use Gauss' Law to find E
- Apply Newton's 2nd Law to find equation of motion

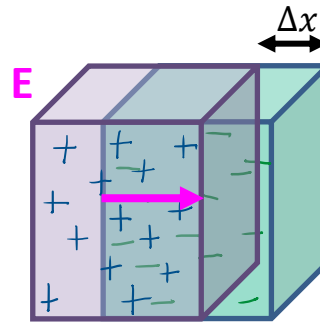

Plasma oscillations

- Plasma frequency

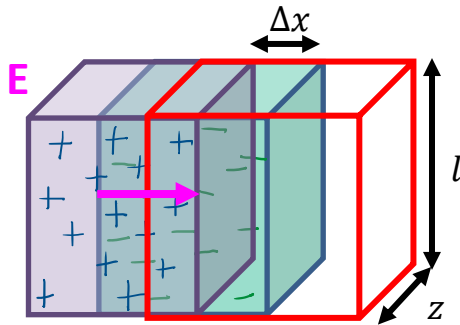

$$\int \vec{E} \cdot d\vec{A} = Q_{enc}/\epsilon_0$$

$$Elz = en_e(\Delta x l z)/\epsilon_0$$

$$E = en_e\Delta x/\epsilon_0$$

$$ma = F$$

$$m_e \frac{d^2 \Delta x}{dt^2} = -eE$$

$$\ddot{x} = -\frac{n_e e^2}{m_e \epsilon_0} x$$

Compare with Hooke's Law $\ddot{x} = -\omega^2 x$

$$\omega_{ps}^2 = \frac{n_s e^2}{\epsilon_0 m_s}$$

Outline

- What is plasma?
 - Occurrence and applications
 - Criteria for plasmas
- A few key concepts
 - Debye length
 - Plasma oscillations
 - **Gyrofrequency**
 - Alfvén waves
- Summary

How to confine a plasma?

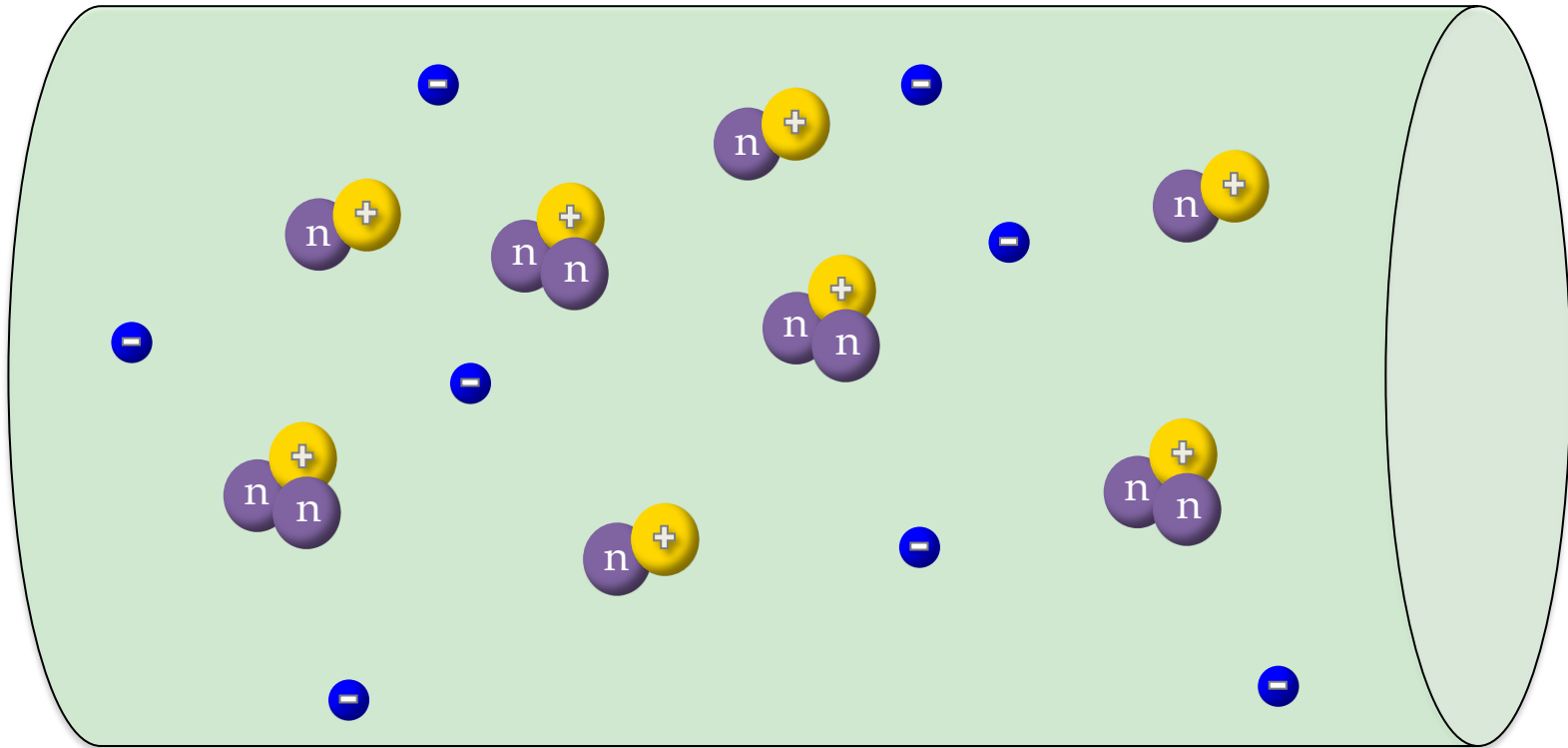

Magnetic fields confine plasmas

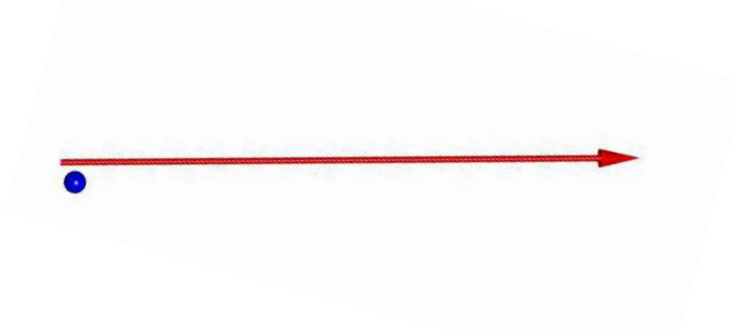
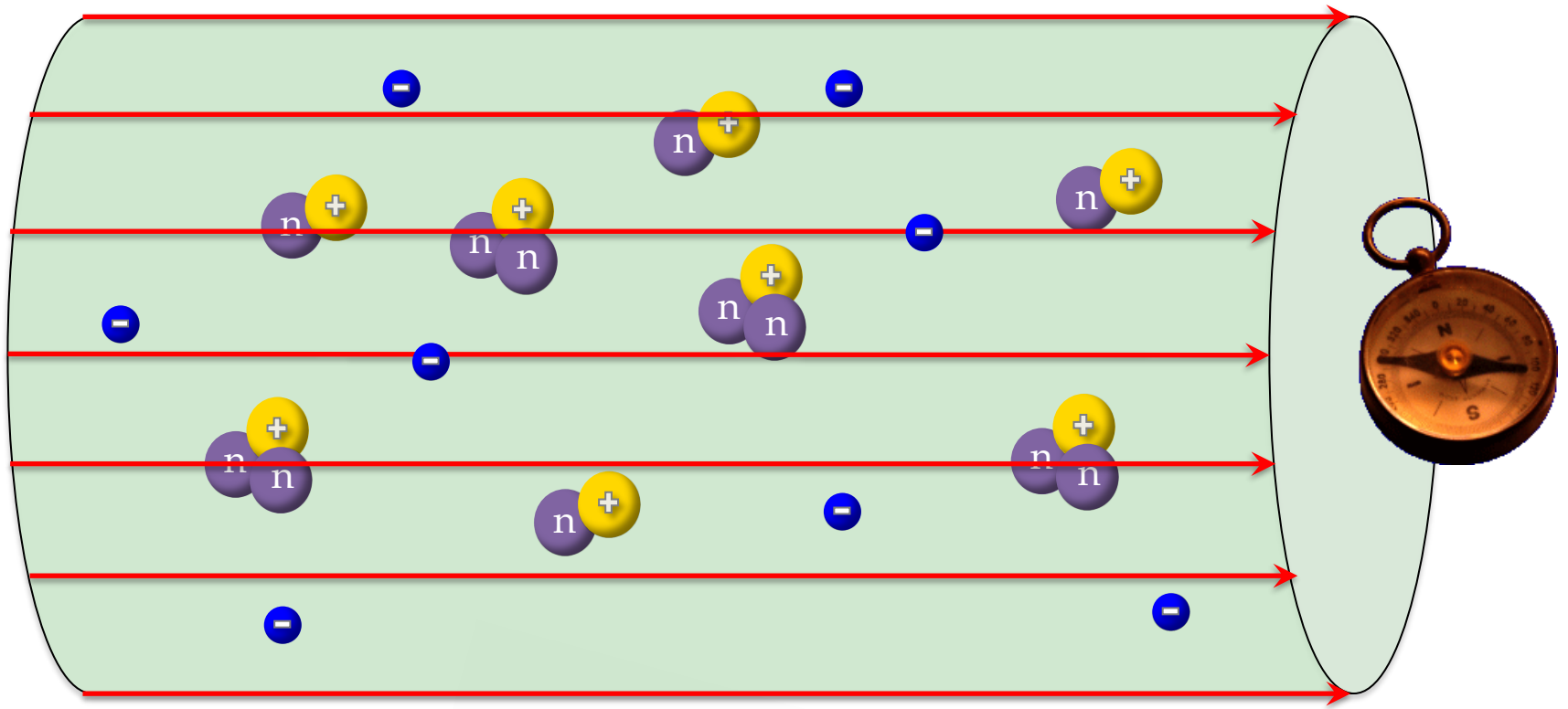

Cyclotron frequency

$$F = ma$$

$$q(\vec{v} \times \vec{B}) = -mv^2/r$$

$$qvB = mv^2/r$$

$$v = qBr/m$$

$$\omega = \frac{v}{r} = \frac{qB}{m}$$

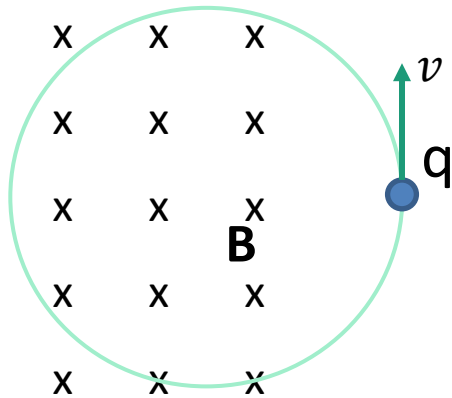

$$\omega_{cs} = \frac{q_s B}{m_s}$$

A torus is the simplest configuration needed to confine plasmas

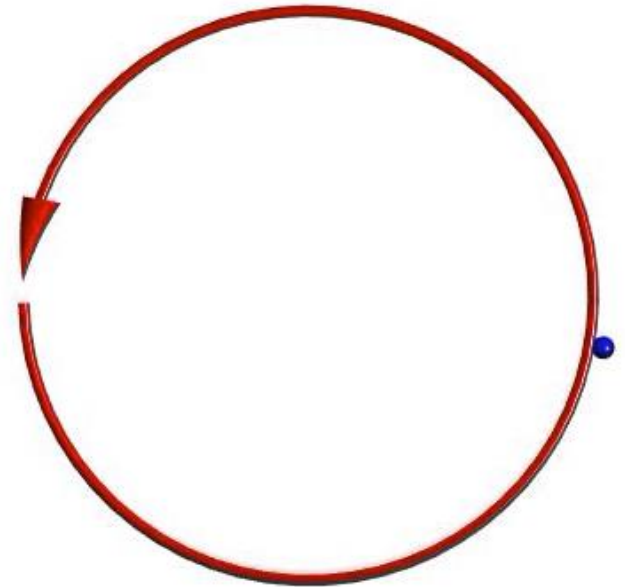

The picture is not simple: particle drifts are ubiquitous \rightarrow a combination of poloidal and toroidal fields is necessary

A torus is the simplest configuration needed to confine plasmas

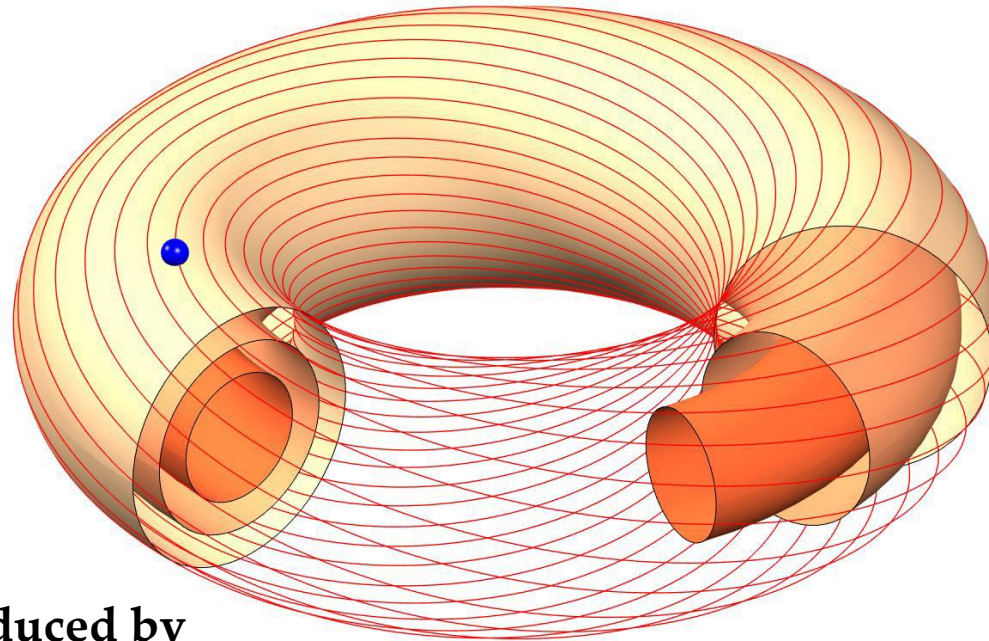

**Toroidal field
(produced by
coils)**

**Poloidal field (produced by
plasma current)**

The key idea is to short-circuit between the top and the bottom of the machine, which leads to canceling of drifts.

Tokamak: toroidal chamber with magnetic coils

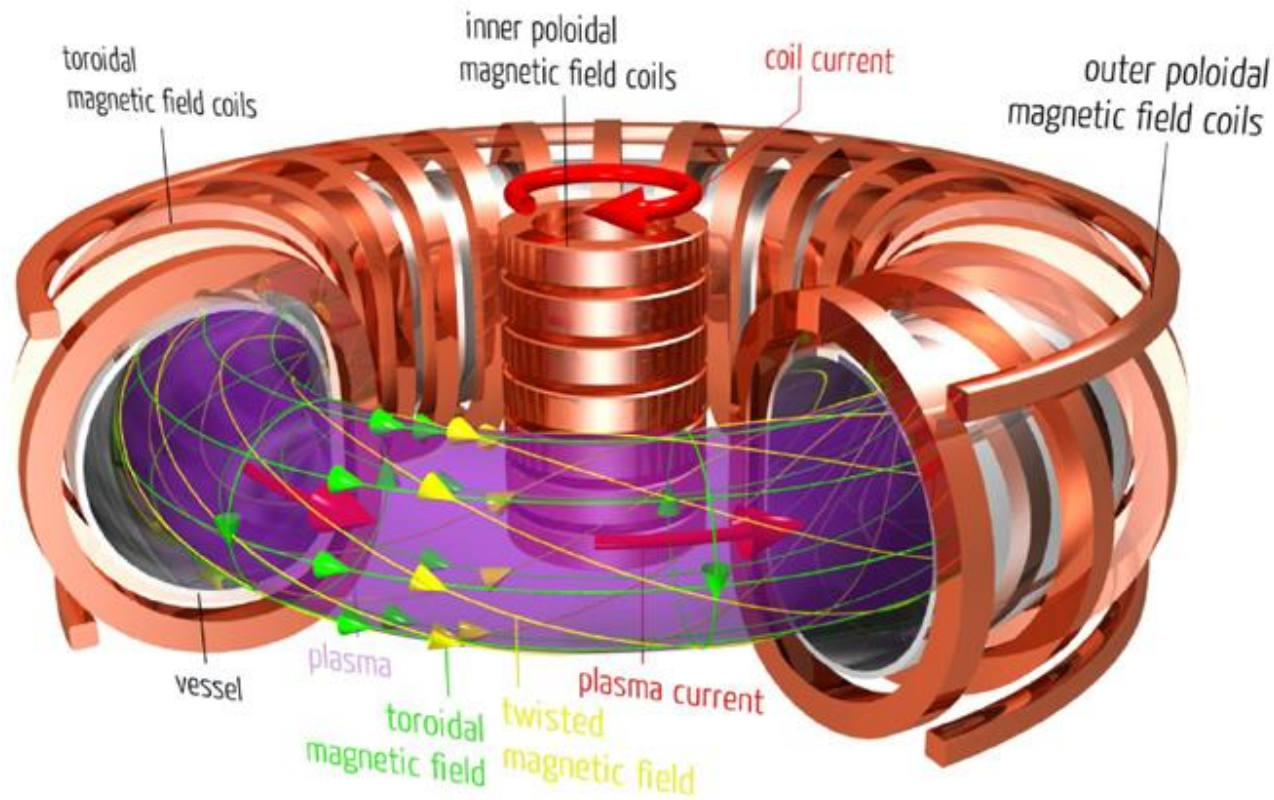

Igor Tamm



Andrei Sakharov

Alternative concepts of plasma confinement

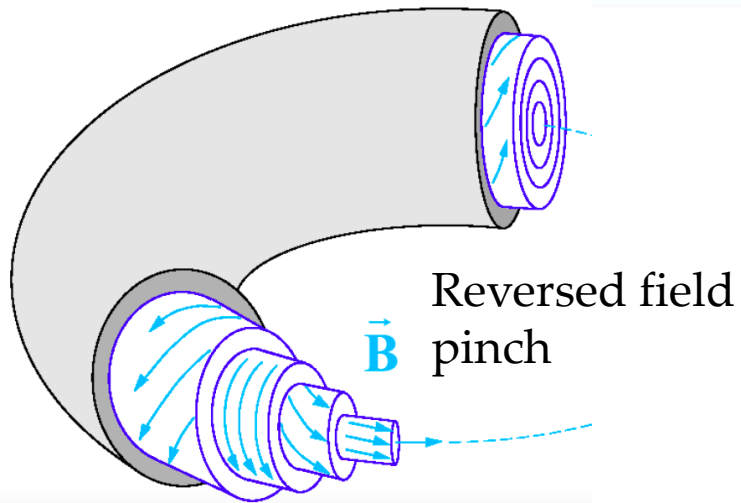
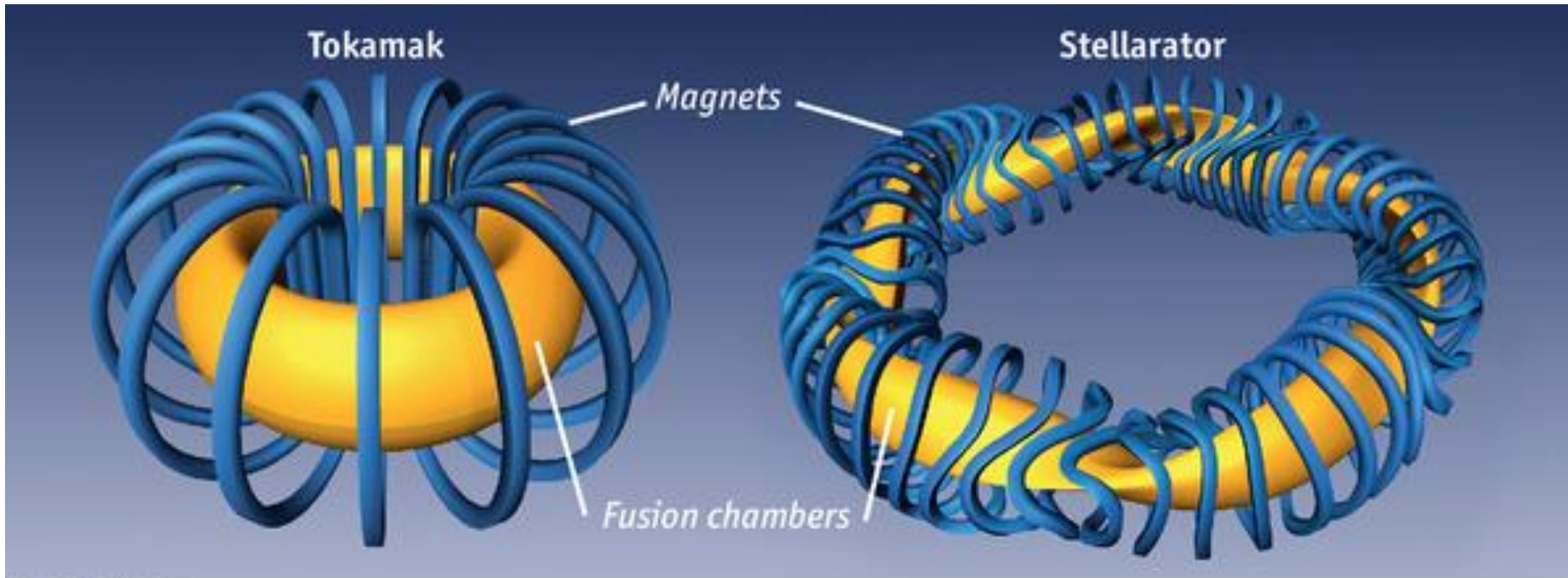

Field reversed configuration

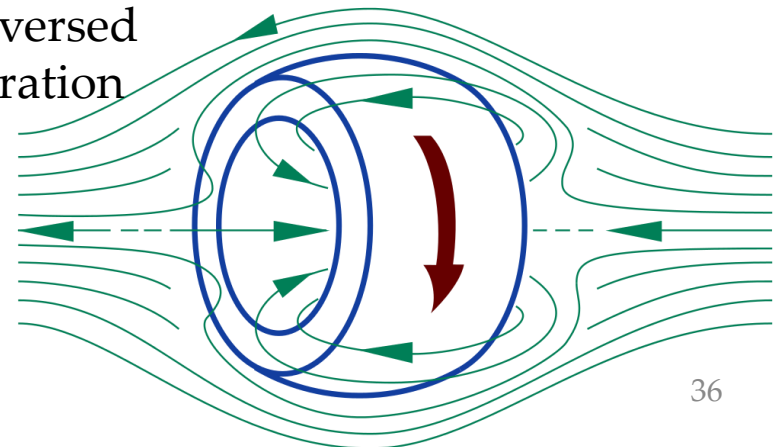

Operating principle of a fusion power plant

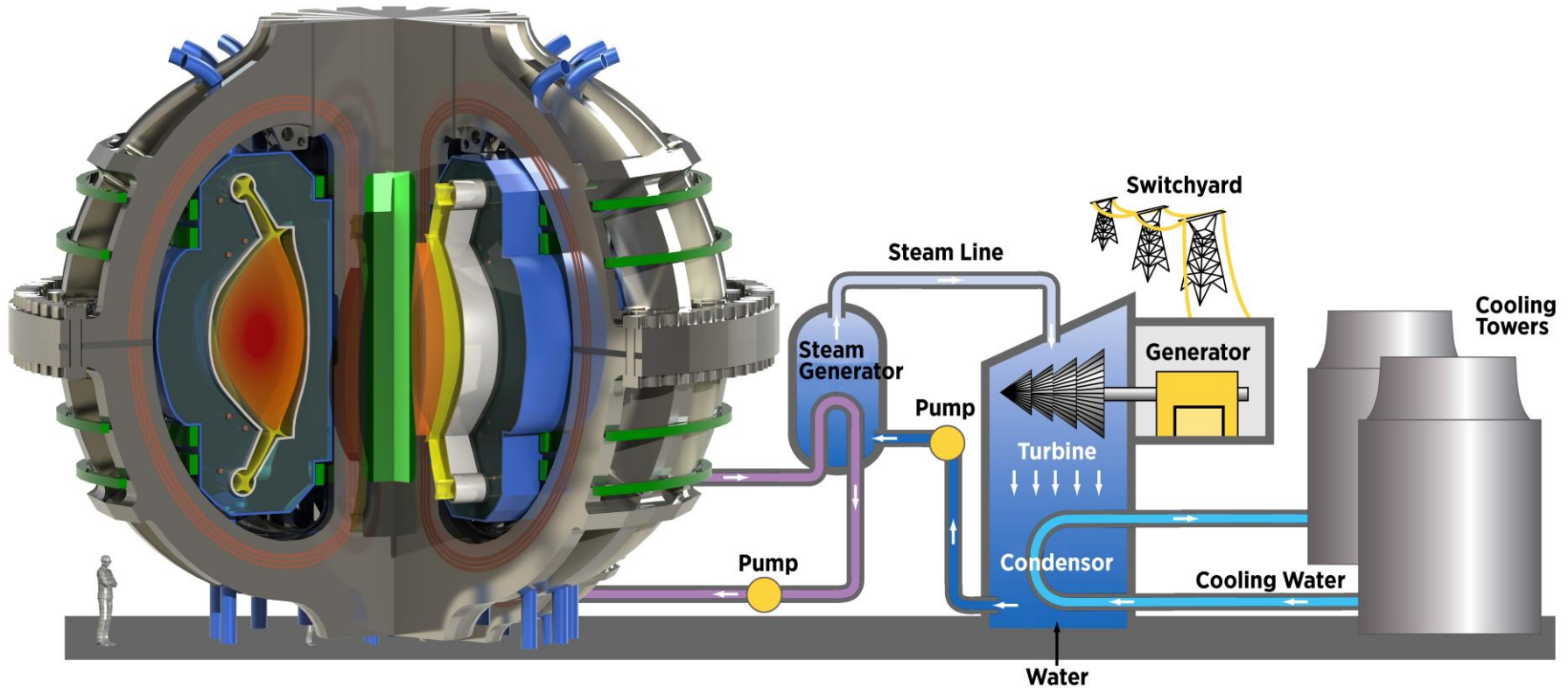

Outline

- What is plasma?
 - Occurrence and applications
 - Criteria for plasmas
- A few key concepts
 - Debye length
 - Plasma oscillations
 - Gyrofrequency
 - **Alfvén waves**
- Summary

Alfvén waves: a fundamental mode of oscillation in plasmas embedded in a magnetic field

Alfvén waves result from the coupling between fluid dynamics and electromagnetism → birth of magnetohydrodynamics

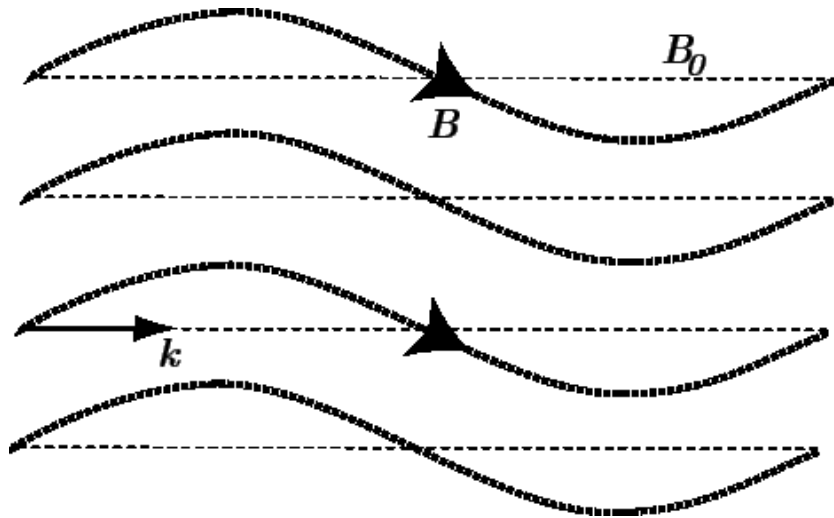

Hannes Alfvén
(1908-1995)
1970 Physics
Nobel Prize

- Alfvén waves can lead to serious instabilities
- They might explain the solar corona heating

University of São Paulo's TCABR tokamak



TCABR is presently undergoing a major upgrade

- manufacturing and installation of a system of innovative coils
- will allow for studies of magnetic perturbations on the plasma confinement

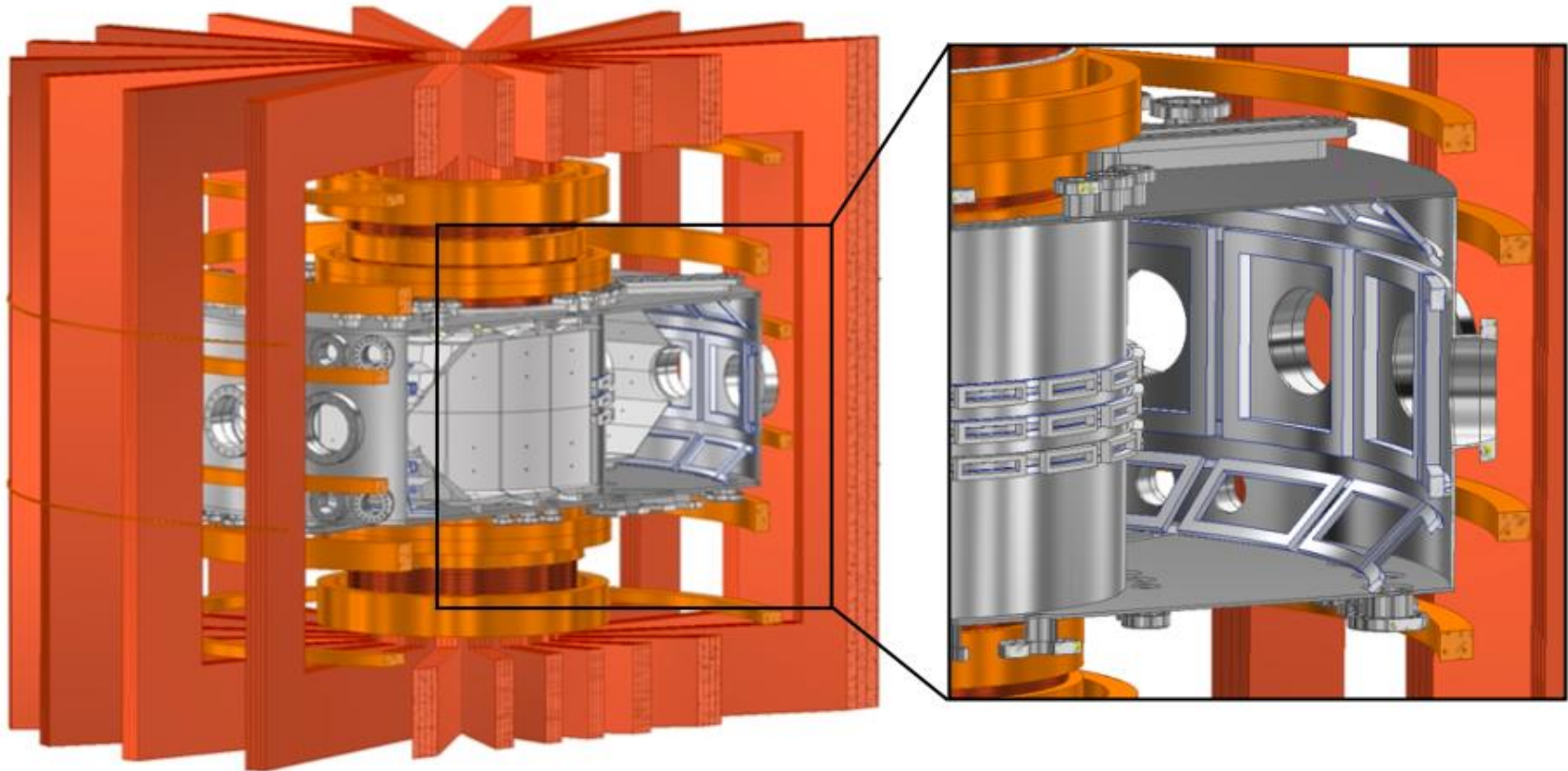

Outline

- What is plasma?
 - Occurrence and applications
 - Criteria for plasmas
- A few key concepts
 - Debye length
 - Plasma oscillations
 - Gyrofrequency
 - Alfvén waves
- **Summary**

Properties of a plasma

1. Conducting medium, with many degrees of freedom
2. Shields electric fields
3. Supports many waves:
 - vacuum waves, such as light waves
 - gas waves, such as sound waves
 - a huge variety of new waves, based on electromagnetic coupling of constituent charged particles, and based on a variety of driving electric and magnetic fields

A more formal definition of a plasma

1. Debye length \ll system characteristic length
2. Large number of particles in a Debye sphere
3. Plasma oscillation period \ll time between collisions

Plasmas are physical systems whose intrinsic properties are governed by collective interactions of large ensembles of free charged particles

Take-aways

- Plasma phenomena appears in a variety of applications: (astrophysics, solar physics, plasma devices, nuclear fusion)
- Controlled fusion can be inertial or magnetic
- Basic time scale of plasma is the plasma oscillation period
- Basic space scale of plasma is the Debye shielding length

Further reading

- Introduction to Plasma Physics, F. F. Chen
- Fundamentals of Plasma Physics, J. A. Bittencourt

